

► METAL

FEIN. Unverwüstliche
Elektrowerkzeuge.



Complete solutions for machining stainless steel surfaces from FEIN.

For results that shine.



Stainless steel shines with possibilities. Make the most of them with FEIN tools and expertise.

Stainless steel is corrosion-resistant and hard-wearing, and literally 'shines' with design possibilities. But until now only users with decades of hands-on experience had the necessary practical expertise to carry out professional, effective work with stainless steel. As an experienced partner to the metal industry, FEIN has an in-depth understanding of the requirements of stainless steel machining and offers a range of optimum solutions in this area. These solutions include durable, robust FEIN products and also special accessories and accessory sets that are specifically tailored to stainless steel applications. Whether you need to give a mirror finish to large surfaces, or machine pipes or profiles in hard-to-reach places, such as hand rails, FEIN can help you achieve optimum results in a fraction of the time.

With robust solutions from FEIN, it's simple and easy to get involved with stainless steel.

Sanding down welded seams, cutting out profiles, or polishing and satin-finishing surfaces to a mirror polish – our durable and practical solutions take account of the particular characteristics of the material (such as heat build-up during surface machining of stainless steel plates), giving you the keys to one of the most exciting markets of the future.

Machining surfaces



Typical applications range from coarse sanding to satin-finishing for a mirror polish. Our tools use cool grinding to avoid warping of the metal. Flexible-use machines such as the FEIN sanding polisher and the perfectly matched modular sets guarantee optimum results.

Machining pipes and profiles



When optimum grinding of welded seams without damaging adjacent surfaces or perfect satin-finishing and polishing for pipe bends the tools have to be partnered perfectly for the surface. With FEIN belt grinders you can grind transitional areas that used to require manual machining in a single process, without dismantling.

Machining corners and edges



Cleaning, removing tarnishing and deburring: FEIN power tools such as fillet weld grinders offer unique robustness and take up little space. With these tools in your toolkit, even grinding transitions in hard-to-reach places is an easy job.

Applications

Machining surfaces	4
All applications at a glance	5
Machining pipes and profiles	6
All applications at a glance	7
Machining pipes and profiles with GRIT	8
All applications at a glance	9
Machining corners and edges	10
All applications at a glance	11
From rough sanding to mirror polish – FEIN stainless steel sets	12

Product

Overview of FEIN machines and sets	14
Compact angle grinder WSG 14-70 E	16
Sets and accessories	17
Compact angle grinder WSG 14-125 S	20
Sets and accessories	21
Sander/polisher WPO 14-25 E	22
Sets and accessories	23
Straight grinder MShy 648-1 Z + accessories	28
Straight grinder AHSl 636 C + accessories	30
Fillet weld grinder KS 10-38 E	32
Pipe sander RS10-70 E	34
Sets and accessories	35

Pipe sander RS 12-70 E	36
Sets and accessories	37
Belt sander BF10-280 E	40
Sets and accessories	41
GRIT belt grinders	42
GRITGX at a glance	43
GRIT GX75 2H	44
GRITGX add-on modules	45
GRITGX accessories	46
GRIT GI at a glance	47
GRIT GI 150 2H	48
GRIT GI add-on modules	49
GRIT GI accessories	50



Top-class results right to the finish – machining surfaces with FEIN.

Large or small, smooth or textured, glossy or matt – the machining solution you choose depends on what your surface looks like now and how you want it to look when you've finished the job. FEIN is the first manufacturer to offer the necessary expertise, the tools, the right accessories and specially matched stainless steel sets for surface machining.

Cleaning off dirt



Fast and efficient cleaning and finishing for large surfaces. The corrugated fleece adapts optimally to embossed surfaces.

Rough material removal



Grind surfaces with sanding sleeves for excellent material removal.

Removing welded seams



With high torque lower-speed grinding, using serrated discs avoids high heat build-up on the material.

Removing scratches



Precise sanding of minor scratches with finishing disc. For deeper scratches use Pyramix sanding discs with hook-and loop fastening.

Removing tarnishing



Effectively remove tarnishing with the corrugated fleece or fleece disc. For optimum adaptation to welded seams.

Satin-finishing



Professional-looking satin-finishing. For a smooth finish across the whole surface.

Preparing for polishing



Optimum preparation for polishing surfaces. The right sanding pattern with rotating procedures.











Polishing to a mirror polish



High-quality polishing results for surfaces, pipes and profiles. Larger tool diameters are available for larger immersion depths.



FEIN power tools and accessories for machining stainless steel surfaces.

Machines	Page	Original FEIN accessories	Cleaning off dirt	Rough material removal	Removing welded seams	Removing scratches	Removing tarnishing	Satin-finishing	Preparing for polishing	Polishing to a mirror polish	
WSG 14-70 E	16-19	 Starter set – Preparing to finish surfaces/pipes/profiles		▲▲	▲▲	▲▲	▲▲		▲		
		 Stainless steel set – preparation for polishing surfaces / pipes / profiles				▲	▲▲		▲▲		
		 Serrated disc/roughing disc		▲▲	▲▲						
		 Fleece sanding disc		▲▲			▲	▲▲			
WSG 14-125 S	20			▲▲	▲▲						
WPO 14-25 E	22-27	 Standard stainless steel set – Surfaces	▲▲			▲	▲▲	▲			
		 Stainless steel set – Satin-finishing surfaces				▲	▲	▲▲			
		 Stainless steel set – Sanding surfaces		▲▲	▲	▲					
		 Stainless steel set – Polishing surfaces/pipes/profiles								▲▲	
		 Extra soft fleece polishing ring, 150 / 200 mm									▲▲
		 Fleece sanding disc		▲▲			▲	▲▲			
		 Corrugated fleece Ø 150 / 200 mm		▲▲				▲▲			

WSG 14-70 E



WSG 14-125 S



WPO 14-25 E



Better machining all round for pipes and profiles? No problem with our stainless steel sets.

The optimum machining of stainless steel pipes and profiles involves a wide range of different challenges. When used in hand rails, for example, they often serve as design element as well as functional element. In cases like these, optimum surface quality is of prime importance. FEIN power tools and stainless steel sets enable you to machine even hard-to-reach places without any need for dismantling – and in a fraction of the time.

Cleaning off dirt



Clean pipes and profiles quickly and efficiently. The corrugated fleece adapts optimally to any given structure.

Removing scratches



Effective removal of scratches on bent handrails and pipes.

Removing welded seams



Remove welded seams without damaging adjacent surfaces: with the special FEIN medium serrated disc.

Removing tarnishing



The sanding polisher WPO 14-25 E: effectively remove tarnishing. Flexible corrugated fleece adapts optimally to the shape of the material.

Satin-finishing



For stainless steel profiles and flat material: satin-finishing with disc fleece wheels.

Preparing for polishing



Polishing of profiles – with optimum preparation using Pyramix and the rotation process.

Polishing to a mirror polish



Achieve the perfect mirror finish, even with larger pipe diameters of up to 120 mm.







Machining fillet welds



Machine fillet welds: from sanding the welded seams to polishing to a mirror finish with the fillet weld sander KS 10-38 E.



FEIN power tools and accessories for machining stainless steel pipes and profiles.

Machines	Page	Original FEIN accessories	Cleaning off dirt	Removing scratches	Removing welded seams	Removing tarnishing	Satin-finishing	Preparing for polishing	Polishing to a mirror polish	Machining fillet welds
WSG 14-70 E	16-19	SET Starter set – Preparing to finish surfaces / pipes / profiles		▲▲	▲▲	▲▲		▲		
		SET Stainless steel set - Sanding pipes / profiles			▲▲	▲▲	▲			
		SET Stainless steel set – Preparing to polish surfaces / pipes / profiles			▲▲	▲			▲▲	
		 Fleece sanding disc	▲▲	▲		▲▲				
WPO 14-25 E	22-27	SET Stainless steel set - Polishing							▲▲	
		SET Stainless steel set – Satin-finishing profiles	▲	▲		▲	▲▲			
		SET Standard stainless steel set – Pipes	▲	▲		▲	▲			
		 Polishing ring (rigid cloth, soft cloth)								▲▲
		 Fleece sanding disc Corrugated fleece Ø 200mm	▲▲	▲		▲▲				
RS 10-70 E	34-35	SET Starter set	▲▲	▲▲	▲	▲▲	▲▲	▲▲		
		 Polishing belts								▲▲
RS 12-70 E	36-39	SET Basic set	▲▲	▲▲	▲	▲▲	▲▲	▲		
		SET Polishing set							▲▲	▲▲
BF 10-280 E	40-41	SET Starter set	▲▲	▲▲	▲	▲	▲	▲		▲
		 Polishing belt + paste								▲▲
KS 10-38 E	33	SET Starter set	▲▲	▲▲	▲	▲	▲▲			▲▲
		 Fleece pressure discs / Felt polishing discs	▲▲	▲▲	▲	▲▲	▲▲	▲▲	▲▲	▲▲

▲ suitable ▲▲ very suitable

WSG 14-70 E



WPO 14-25 E



RS 10-70 E



RS 12-70 E



BF 10-280 E



KS 10-38 E



Industrial machining of pipes and profiles? Better choose GRIT.

Stationary GRIT belt grinders are powerful, robust and modular. With a combination of special grinding belts, they create individual grinding patterns. As another benefit, because pipes and profiles are often ground as part of automatic production processes, GRIT machines are also optimised for volume production.

Deburring



GRIT deburring machines with stainless steel brushes for efficient deburring of manageably sized workpieces.

Radius grinding



Precision grinding in seconds with GRIT radius grinding modules.

Grinding mitre joints



Accurate grinding of mitre joints with mitre joint grinding plate and GIR.

Removing scratches



Scratches are removed in an automated process.

Preparing welded seams



Virtually vibration-free preparation of welded seams, maximum material removal and low tool costs: with the GRIT grinding belt quality "R".

Satin-finishing



GRIT gives profiles a perfect satin finish.

Preparing for polishing



GRIT GIC centreless grinding module: create a grinding pattern to prepare for polishing pipes.



GRIT stationary belt grinders and accessories for machining stainless steel pipes and profiles.

Machines	Page	Deburring	Radius grinding	Grinding mitre joints	Removing scratches	Preparing welded seams	Satin-finishing	Preparing for polishing	
GX 75 2H	42-46	▲▲			▲	▲▲			
GX 75 2H+GXR			▲▲						
GX 75 2H+GXC+GXW					▲▲		▲▲	▲▲	
GXE		▲▲							
GI 150 2H+GIBE	47-51	▲▲			▲	▲▲			
GI 150 2H+GIBE+GIL					▲▲		▲▲	▲▲	
GI 150 2H+GIBE+GIR			▲▲	▲▲					
GI 75 2H/GI 150 2H+GIB+GIC+GXW						▲▲		▲▲	▲▲
GIE		▲▲							

GX 75 2H



GX 75 2H+GXR



GX 75 2H+GXC+GXW



GXE



GI 150 2H+GIBE



GI 150 2H+GIBE+GIL



GI 150 2H+GIBE+GIR



GI 150 2H + GIB + GIC + GXW



GIE



Perfect machining of corners and edges – with tools and expertise from FEIN.

Professional sanding and polishing of corners and edges is one of the most demanding tasks when machining stainless steel surfaces. This is because they are often difficult to access, which requires the machines and tools used to be extremely manageable and manoeuvrable.

Deburring



GRIT deburring machines with stainless steel brushes for efficient deburring of manageably sized workpieces.

Preparing welded seams



GRIT high-performance grinding belts for maximum material removal.

Removing welded seams



FEIN medium serrated discs for removing fine welded seams without damaging adjacent surfaces.

Removing tarnishing



Ideal for hard-to-reach spots: the handy belt sander BF 10-280 E with swivelling grinding arm.

Sanding fillet welds











Efficient machining, from sanding to mirror polish, with the fillet weld sander.





FEIN power tools, GRIT stationary belt grinders and accessories for machining corners and edges.

Machines	Page	Original FEIN accessories	Deburring	Preparing welded seams	Removing welded seams	Removing tarnishing	Sanding fillet welds
WSG 14-70 E	16–19		▲▲	▲▲	▲▲	▲	
WSG 14-125 S	20–21		▲▲	▲▲	▲▲		
WPO 14-25 E	22–27	 Sanding fleece with corrugation Ø 200mm				▲▲	
KS 10-38 E	32–33	 Starter set			▲	▲▲	▲▲
BF 10-280 E	40–41	 Starter set	▲▲		▲	▲▲	▲▲
		 Ceramic grinding belt, grit 80			▲▲		▲
GX 75 2H	44	 GRIT grinding belt quality R	▲▲	▲▲			
GXE	45	 Stainless steel brush	▲▲				
GI 150 2H + GIBE	48–49	 GRIT grinding belt quality R	▲▲	▲▲			
GIE	49–50	 Stainless steel brush	▲▲				
MShy 648 1Z	28–29				▲	▲▲	
ASHI 636 C	30–31				▲	▲▲	

WSG 14-70 E



WSG 14-125 S



WPO 14-25 E



BF 10-280 E



MShy 648 1Z



ASHI 636 C



KS 10-38 E



GX 75 2H



GXE



GI 150 2H+GIBE



GIE



From rough grinding to mirror polish – FEIN stainless steel sets.

FEIN supplies carefully chosen accessories for any desired surface quality in tried-and-tested FEIN stainless steel sets. The sets are specifically matched for the particular machine – the compact angle grinder WSG 14-70 E or the sanding polisher WPO 14-25 E – and the application. Please refer to the following table to find out which set is best for your application. All you need to know is the initial condition of the surface, the area of use or workpiece, and the desired result.



Surface with minor scratches

1 Standard stainless steel set – Surfa



Surface with rough welded seam

2 Stainless steel set – Sanding surfaces

p23



Surface with fine welded seam

4 Stainless steel set – Preparing to polish surfaces / pipes / profiles



Pipes with scratches

6 Standard stainless steel set – Pipes



Pipes / profiles with welded seams

7 Stainless steel set – Sanding pipes / profiles





FEIN compact angle grinder
WSG 14-70 E



FEIN sanding polisher
WPO 14-25 E



4 Stainless steel set – Preparing to polish surfaces / pipes / profiles



7 Stainless steel set – Sanding pipes / profiles



1 Standard stainless steel set – Surfaces



2 Stainless steel set – Sanding surfaces



3 Stainless steel set – Satin-finishing surfaces



6 Standard stainless steel set – Pipes



8 Stainless steel set – Satin-finishing profiles



5 Stainless steel set – Polishing surfaces / pipes / profiles

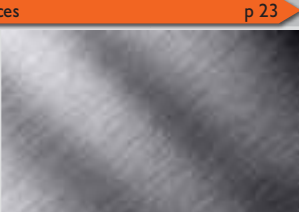

p 23

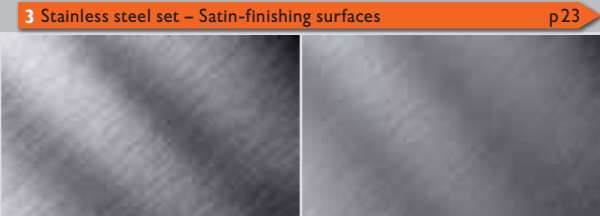

3 Stainless steel set – Satin-finishing surfaces

p 23

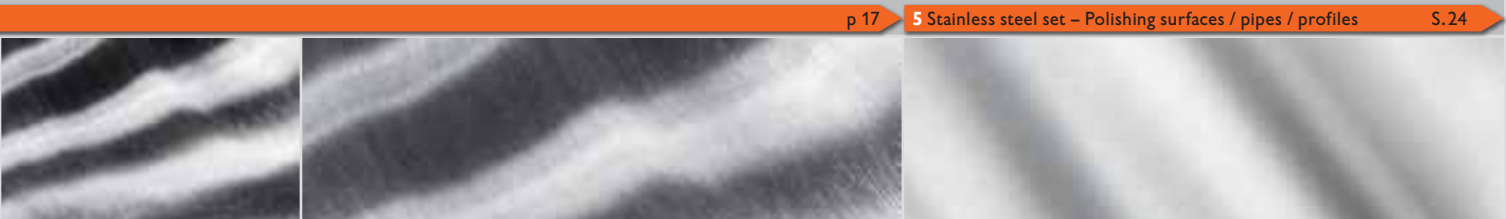

p 17

5 Stainless steel set – Polishing surfaces / pipes / profiles

S. 24



p 23



8 Stainless steel set – Satin-fin. prof. p 24

The FEIN stainless steel range – robust machines and sets.

Surfaces, pipes and profiles, or corners and edges: FEIN offers a complete range of diverse, specialised products for machining stainless steel. From individual machines like angle grinders, sanding polishers, pipe sanders and stationary belt grinders, FEIN can tailor to a specific stainless steel application using the right accessories, or accessory set.

Need to remove dirt, tarnishing, scratches or welded seams? Need to prepare a surface for polishing or polish it to a mirror polish? FEIN has the right solution for any stainless steel surface and any stainless steel application. Durable, robust tools and accessories that allow you to work faster, more conveniently and more efficiently than ever before.



Overview of FEIN machines and sets.



Compact angle grinder WSG 14-70 E **page 16**

- ▶ Stainless steel set - Sanding pipes / profiles
- ▶ Stainless steel set - Preparing to polish surfaces / pipes / profiles



Compact angle grinder WSG 14-125 S **page 20**



Sander / Polisher WPO 14-25 E **page 22**

- ▶ Stainless steel set – Satin-finishing profiles
- ▶ Standard stainless steel set – Surfaces
- ▶ Stainless steel set – Polishing surfaces / pipes / profiles
- ▶ Standard stainless steel set – Pipes
- ▶ Stainless steel set – Sanding surfaces
- ▶ Stainless steel set – Satin-finishing surfaces



Straight grinder MSHY 648-1 Z **page 28**



Straight grinder AHSI 636 C **page 30**



Fillet weld sander KS 10-38 E **page 32**



Pipe sander RS 10-70 E **page 34**



Pipe sander RS 12-70 E **page 36**



Belt sander BF 10-280 E **page 40**

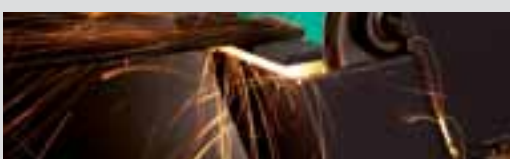

Belt grinder GRIT GX 75 2H **page 42**

- ▶ Radius grinding module GXR
- ▶ Rotary grinding module GXC
- ▶ Cooling lubricant module GXW
- ▶ Deburring machine GXE



Belt grinder GRIT GI 150 2H **page 47**

- ▶ Radius grinding module GIR
- ▶ Rotary grinding module GIC
- ▶ Surface grinding module GIL
- ▶ Deburring machine GIE

FEIN compact angle grinder WSG 14-70 E starter set. Preparing to finish surfaces / pipes / profiles.

As a powerful compact angle grinder with variable speed for machining stainless steel, the WSG 14-70 E offers an optimised speed range for stainless steel surfaces and high cutting performance, particularly for precise material removal. The speed is infinitely variable and the tool's HIGH POWER MOTOR supplies it with very high torque.

Benefits:

- ▶ Variable speed allows various accessories to be used and preserves surfaces.
- ▶ Anti-vibration handle for fatigue-free working.
- ▶ H 07 industrial cable.
- ▶ Dustproof tacho control.
- ▶ Sealed electronic parts.
- ▶ Soft start.



Ergonomic shape

Ergonomic shape so you can work comfortably and without fatigue.

Variable speed

Infinitely variable speed. The selected speed remains constant in all load situations.

HIGH-POWER-MOTOR

Effective material removal over the full working range and load of up to 150%.

Minimal vibrations

Best vibration values for up to 8 hours.

Long service life

Impressive lifetime and very long service life thanks to the special self-supporting motor design, metal drive head and dustproof ball bearing.

Technical data

Model		WSG 14-70 E
Power / consumption	w	1200
Power / output	w	750
Idling speed	rpm	2500 – 7000
Cable with plug	m	4
Weight according to EPTA	kg	2.4
Tool holder		
Flanges		M 14
Sanding disc Ø	mm	125
Elastic backing pad Ø	mm	125



FEIN Compact angle grinder WSG 14-70 E starter set

Ideal for preparing to finish surfaces, pipes and profiles. The accessories in this starter set guarantee fast results with high sanding capacity, whether for smoothing welded seams, removing scratches or systematically building up a grinding pattern.



- ▶ Compact angle grinder WSG 14-70 E in plastic case
- ▶ 1 medium serrated sanding disc, diameter 125 mm
- ▶ 1 finishing disc, diameter 125 mm
- ▶ 5 Pyramix perforated sanding sheets, grit 280, diameter 115 mm
- ▶ 5 Pyramix perforated sanding sheets, grit 400, diameter 115 mm
- ▶ 5 Pyramix perforated sanding sheets, grit 800, diameter 115 mm
- ▶ 25 sanding sheets, grit 80, diameter 115 mm
- ▶ 1 cooling backing pad, diameter 75 mm, M14
- ▶ 1 support plate, diameter 115 mm, M14

Order number

7 221 43 61

WSG 14-70 E



Powerful compact angle grinder with variable speed control, ideal for machining stainless steel. Supplied in box without accessories.

Included in price:

1 safety hood, 1 pair of flanges,
1 anti-vibration handle, 1 wrench

Order number	7 221 43
--------------	----------

Stainless steel sets



➤ Stainless steel set – Sanding pipes / profiles

Sand fine welded seams without damaging adjacent surfaces. With subsequent surface finish.

Also included:

10x medium serrated sanding discs (6 37 30 018 01 0)

1 flap wheel, Grit 120 (6 37 21 052 01 0)

1 finishing disc (6 37 32 005 01 0)

Set requires

Angle grinder FEIN WSG 14-70 E



Order number 6 37 21 052 02 0



➤ Stainless steel set – Preparing to polish surfaces / pipes / profiles

Quickly and effectively removes scratches; optimum preparation for polishing with matched sanding pattern; when preparing for polishing, effective material removal in little time.

Also included:

Pyramix perforated sanding sheets, grit 280, diameter 115 mm, pack of 5 (6 37 17 239 01 0)

Pyramix perforated sanding sheets, grit 400, diameter 115 mm, pack of 5 (6 37 17 240 01 0)

Pyramix perforated sanding sheets, grit 800, diameter 115 mm, pack of 5 (6 37 17 241 01 0)

Pyramix perforated sanding sheets, grit 1400, diameter 115 mm, pack of 5 (6 37 17 242 01 0)

Cooling backing pad, diameter 75 mm, M14, pack of 1 (6 38 06 196 01 0)

Sanding sheets, diameter 115 mm, grit 80, pack of 25 (6 37 28 135 01 0)

Cooling backing pad, diameter 115 mm, M14, pack of 1 (6 38 06 193 01 0)

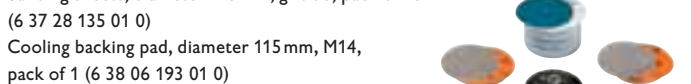

Set requires

Angle grinder FEIN WSG 14-70 E

Order number 6 38 06 193 04 0

Other accessories

Tool case

Plastic, 450x310x135 mm.



Order number 3 39 01 118 01 0

Plastic box

Case insert with lockable lid for small parts and accessories, suitable for tool case 3 39 01 181 01 0, max. 5 per case



Order number 3 39 01 119 00 0

Anti-vibration handle

M8, vibration-absorbing, to reduce vibrations during longer jobs



Order number 3 21 19 124 01 0

Elastic backing pad

Ø 125mm, with M14 flange, for fibre sanding discs.



Order number 6 38 06 087 01 3

Support plate

Ø 125 mm, with hook and loop fastening, for use with sanding fleece, sanding sheets or Pyramix with hook and loop fastening, M14.



Order number 6 38 06 168 01 2

INOX round twist brush

Ø 115 mm, M14



Order number 6 37 22 049 01 8

Inner flange



Order number 6 38 01 120 00 6

Threaded flange M14

for roughing discs, cutting wheels, serrated sanding discs and round twist brushes.



Order number 6 38 02 052 00 0

Threaded flange M14

for elastic backing pads and tapered twist brushes.



Order number 6 38 01 154 00 7

Support plate

Ø 115 mm, with hook and loop fastening, for use with sanding fleece, sanding sheets or Pyramix M14.



Order number 6 38 06 172 01 0

Universal dust extraction device

Ø 125 mm, for serrated sanding discs, elastic backing pads, support plates and tapered twist brushes.



Order number 9 26 02 067 01 6

Strip brush

for universal dust extraction device.

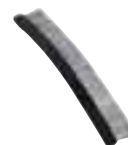

Order number 3 32 18 101 01 4



Sanding fleece discs

Ø 115 mm, stable, with hook and loop fastening, for use with support plate 6 38 06 172 01 0.



Version	No. in pack	Order number
course	10	6 37 32 001 01 8
medium	10	6 37 32 002 01 1
fine	10	6 37 32 003 01 5

Cooling backing pad

Ø 115 mm, rear-ventilated backing pad, ideal for Pyramix sanding discs M14.



Order number 6 38 06 193 01 0

Cooling backing pad

Diameter 75 mm, M14, suitable for Pyramix sanding disc once the outer edge has been removed.



Order number 6 38 06 196 01 0

Sanding sheet, grit 80

Diameter 115 mm, high sanding capacity and long service life. Ideal for removing very deep scratches and fine welded seams from stainless steel. Pack of 25.



Order number 6 37 28 135 01 0

Pyramix sanding disc

Ø 115 mm

Practical: the new perforation pattern means that the edge can be removed and the sanding disc used on a smaller backing pad (75 mm in diameter).

Diameter of 115 mm with various grits. Pack size: 5 or 25.



No. in pack	Grit	Order number
5	280	6 37 17 239 01 0
25	280	6 37 17 239 02 0
5	400	6 37 17 240 01 0
25	400	6 37 17 240 02 0
5	800	6 37 17 241 01 0
25	800	6 37 17 241 02 0
5	1400	6 37 17 242 01 0
25	1400	6 37 17 242 02 0

Flap wheel, grit 120

For smooth buildup of radial sanding pattern, grit 120. Pack of 1.



Order number 6 37 21 052 01 0

Finishing disc

Ø 125 mm, for final finish. Pack of 1.



Order number 6 37 32 005 01 0

Serrated sanding disc medium

Ø 125 mm, for removing fine welded seams without damaging adjacent surfaces. No. in pack 10.



Order number 6 37 30 018 01 0

FEIN Compact angle grinder WSG 14-125 S – mechanically reduced speed for maximum performance.

As a powerful compact angle grinder with reduced speed yet high torque and speed stability, the WSG 14-125 S is ideal for machining stainless steel with serrated discs.

Benefits:

- ▶ Unique ergonomic design for fatigue-free working. Equally suited to right- and left-handers.
- ▶ H 07 industrial cable.
- ▶ Captive safety hood with protection against twisting.
- ▶ Soft start.
- ▶ Restart lock.

Ergonomic shape

Ergonomic shape so you can work comfortably and without fatigue.

HIGH-POWER-MOTOR

Effective material removal over the full working range and load of up to 150%.

Minimal vibrations

Best vibration values for up to 8 hours.

Long service life

Impressive lifetime and very long service life thanks to the special self-supporting motor design, metal drive head and dustproof ball bearing.



Technical data

		WSG 14-125 S
Model		WSG 14-125 S
Power / consumption	w	1200
Power / output	w	750
Idling speed	rpm	7000
Cable with plug	m	4
Weight according to EPTA	kg	2.4
Tool holder		
Flanges		M 14
Sanding disc Ø	mm	125
Elastic backing pad Ø	mm	125



WSG 14-125 S



Powerful compact angle grinder for grinding and cutting work on stainless steel.

Supplied in box without accessories.

Included in price:

1 safety hood, 1 pair of flanges, 1 anti-vibration handle, 1 wrench

Order number 7 221 44

Accessories

Tool case

Plastic, 450 x 310 x 135 mm.



Order number 3 39 01 118 01 0

Plastic box

Case insert with lockable lid for small parts and accessories, suitable for tool case 3 39 01 181 01 0, max. 5 per case.



Order number 3 39 01 119 00 0

Anti-vibration handle

M8, vibration-absorbing, to reduce vibrations during longer jobs.



Order number 3 21 19 124 01 0

Elastic backing pad

with M14 flange, for fibre sanding discs Ø 125 mm.



Order number 6 38 06 087 01 3

INOX round twist brush

Ø 115 mm, M14.



Order number 6 37 22 049 01 8

Inner flange



Order number 6 38 01 120 00 6

Threaded flange M14

for roughing discs, cutting wheels, serrated sanding discs and round twist brushes.



Order number 6 38 02 052 00 0

Threaded flange M14

for elastic backing pads and tapered twist brushes.



Order number 6 38 01 154 00 7

Universal dust extraction device

Ø 125 mm, for serrated sanding discs, elastic backing pad, support plates and tapered twist brushes.



Order number 9 26 02 067 01 6

Strip brush

for universal dust extraction device.

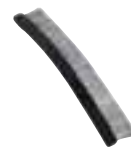

Order number 3 32 18 101 01 4

FEIN Sanding polisher WPO 14-25 E – power and flexibility in one.

The WPO 14-25 E combines several machines in one: a fully-functional sander, polisher and satin-finisher. Featuring a mechanical gear reduction and the FEIN HIGH-POWER-MOTOR, this machine is extremely powerful even at low speeds. The variable speed adjustment makes it ideal for machining stainless steel surfaces.

Benefits:

- ▶ Extremely powerful even at low speed.
- ▶ Can be used universally as a grinder, polisher and satin-finisher.
- ▶ High torque thanks to mechanical gear reduction.
- ▶ Continuously adjustable speed.
- ▶ Outstanding ergonomics for right- and left-handers.
- ▶ Soft start.
- ▶ H 07 industrial cable.

Ergonomic shape

Particularly ergonomic shape so you can work comfortably and without fatigue.

Variable speed

Infinitely variable speed. The selected speed remains constant in all load situations.



HIGH-POWER-MOTOR

Effective material removal over the full working range and load of up to 150%.

Long service lives

Impressive lifetime and very long service lives thanks to the special self-supporting motor design, metal drive head and dustproof ball bearing.

Double gear reduction

Maintains a constant speed even under very high load.

Technical data

Model		WPO 14-25 E
Power / consumption	w	1200
Power / output	w	750
Idling speed	rpm	900–2 500
Cable with plug	m	4
Weight according to EPTA	kg	2.5
Tool holder		
Flanges		M 14
Polishing tool Ø	mm	230



FEIN Sanding polisher WPO 14-25 E starter set



Stainless steel starter set for all standard applications in surface machining: removing tarnishing, dirt and minor scratches and achieving a high-quality satin finish.

- ▶ Tool in case
- ▶ 1 lamella fleece cylinder, grit 180
- ▶ 1 elastic sanding cylinder, grit 60
- ▶ 10 x sanding fleece with fine hooks and support plate
- ▶ 1 holder
- ▶ 2 wrenches
- ▶ 2 work arbores
- ▶ 1 corrugated sanding fleece

Order number **7 221 49 50**

WPO 14-25 E



Extremely powerful sander/polisher for cool machining of stainless steel surfaces.
Supplied in box without accessories.

Included in price:
1 anti-vibration handle,
1 allen key

Order number	7 221 49
--------------	----------

Stainless steel sets



1 Standard stainless steel set – Surfaces

Set for standard applications in surface machining: cleaning off dirt with corrugated fleece, removing tarnishing and achieving a high-quality satin finish.

Also included:

- 1 elastic sanding cylinder, Grit 60 (6 37 21 006 01 2)
- 1 lamella fleece cylinder (6 37 21 009 01 8)
- 1 corrugated sanding fleece (6 37 23 021 01 3)
- 1 fine fleece sanding disc, pack of 10 (6 37 32 003 01 5)
- 1 support plate (6 38 06 172 01 0)
- 1 work arbour (6 38 03 066 02 4)
- 1 pin-type face spanner (6 29 10 022 00 2)
- 1 open-ended spanner 19 x 22 (6 29 04 003 00 0)

Set requires

- Sanding polisher WPO 14-25 E
- Holder (6 37 33 006 01 0)
- Work arbour (6 38 03 067 02 8)
- Safety hoop (3 02 29 216 00 5)



Order number 6 37 21 006 04 0



2 Stainless steel set – Sanding surfaces

Effective material removal for surfaces.

Also included:

- 1 expansion cylinder (6 38 06 192 01 0)
- 5 sanding sleeves, Grit 60 (6 37 14 132 01 0)
- 5 sanding sleeves, Grit 80 (6 37 14 133 01 0)
- 5 sanding sleeves, Grit 120 (6 37 14 134 01 0)

Set requires

- Sanding polisher WPO 14-25 E
- Holder (6 37 33 006 01 0)
- Safety hoop (3 02 29 216 00 5)
- Work arbour (6 38 03 067 02 8)



Order number 6 38 06 192 02 0



3 Stainless steel set – Satin-finishing surfaces

Perfect, smooth satin finish. Very low build-up of heat during machining.

Also included:

- 1 elastic sanding cylinder, Grit 60 medium (6 37 21 006 01 2)
- 1 elastic sanding cylinder, Grit 180 fine (6 37 21 007 01 6)
- 1 sine fleece sanding cylinder, Grit 180 fine (6 37 21 051 01 0)

Set requires

- Sanding polisher WPO 14-25 E
- Holder (6 37 33 006 01 0)
- Safety hoop (3 02 29 216 00 5)
- Work arbour (6 38 03 067 02 8)



Order number 6 37 21 050 02 0



6 Standard stainless steel set – Pipes

Set for standard applications in the machining of straight pipes. Cleaning off dirt, removing tarnishing and achieving a high-quality satin finish.

Also included:

- 1 sanding belt roller (6 38 06 181 01 6)
- 1 sanding belt, Grit 60, pack of 10 (6 37 14 044 01 0)
- 1 sanding belt, Grit 120, pack of 10 (6 37 14 045 01 4)
- 1 medium fleece belt (6 37 14 048 01 9)
- 1 fine fleece belt (6 37 14 049 01 3)
- 1 adhesive strip (6 38 09 004 01 9)

Set requires

- Sanding polisher WPO 14-25 E
- Holder (6 37 33 006 01 0)
- Safety hoop (3 02 29 216 00 5)
- Work arbour (6 38 03 067 02 8)



Order number 6 38 06 181 03 0

Stainless steel sets



8 Stainless steel set – Satin-finishing profiles

The accessories for smooth satin finishes on profiles and narrow surfaces guarantee a perfect sanding pattern and a very low build-up of heat. The new, 50 mm wide cylinders ensure effective progress.

Also included:

- Elastic cylinder, grit 60 medium, 100 x 50 (6 37 21 054 01 0)
- Elastic cylinder, grit 180 fine, 100 x 50 (6 37 21 055 01 0)
- Sine fleece sanding cylinder, grit 180 fine, 100 x 50 (6 37 21 056 01 0)
- Work arbour 50mm, M14 (6 38 03 071 02 0)

Set requires

- Sanding polisher WPO 14-25 E
- Holder (6 37 33 006 01 0)
- Safety hoop (3 02 29 216 00 5)



Order number	6 37 21 054 02 0
--------------	------------------

5 Stainless steel set – Polishing surfaces/pipes/profiles

Gives surfaces a mirror polish. No lint build-up on the polishing rings.

Also included:

- 1 sisal polishing ring (6 37 23 011 01 4)
- 2 rigid polishing ring cloth (6 37 23 013 01 1)
- 2 soft polishing ring cloth (6 37 23 014 01 9)
- 1 brush paste (6 37 26 027 01 0)
- 1 pre-polishing paste (6 37 26 028 01 0)
- 1 colouring paste (6 37 26 029 01 0)
- 1 work arbour (6 38 03 027 03 8)
- 1 pin-type face spanner (6 29 10 022 00 2)
- 1 open-ended spanner 19x22 (6 29 04 003 00 0)

Set requires

- Sanding polisher WPO 14-25 E
- Holder (6 37 33 006 01 0)
- Safety hoop (3 02 29 216 00 5)



Order number	6 37 23 011 04 0
--------------	------------------

Other accessories

Elastic sanding cylinder

Ø 100 x 100mm



Grit	Version	Order number
60	medium (green)	6 37 21 006 01 2
180	fine (blue)	6 37 21 007 01 6

Elastic sanding cylinder

Ø 100 x 50mm, cool sanding for smooth perfect grinding of profiles with thin walls and narrow surfaces.



Grit	Version	Order number
60	medium (green)	6 37 21 054 01 0
180	fine (blue)	6 37 21 055 01 0

Corrugated sanding fleece

Width approx. 30 mm, bore 14 mm, for light-duty deburring, deoxidation, light-duty sanding, decorative work.



Ø mm	Order number
150	6 37 23 021 01 3
200	6 37 23 022 01 6

INOX round twist brush

Ø 115 mm, M14



Order number	6 37 22 049 01 8
--------------	------------------

Sine sanding fleece cylinder

Ø 100 x 100mm, with sine wave, for smooth satin finish.



Grit	Version	Order number
180	fine (brown)	6 37 21 051 01 0

Sine fleece sanding cylinder, fine

Grit	Version	Order number
180	fine (brown)	6 37 21 056 01 0

Sanding fleece discs

Ø 115 mm, stable, with hook and loop fastening, for use with support plate 6 38 06 172 01 0.



Version	No. in pack	Order number
coarse	10	6 37 32 001 01 8
medium	10	6 37 32 002 01 1
fine	10	6 37 32 003 01 5

Sanding belt roller

100 x 70mm



Order number	6 38 06 181 01 6
--------------	------------------

Flap wheel

Ø 150 mm



for remedying minor mistakes and scratches Grit 40

Order number	6 37 21 003 01 7
--------------	------------------

for medium brush strokes Grit 60

Order number	6 37 21 004 01 5
--------------	------------------

for fine brush strokes, satin finish

Grit 80	
---------	--

Order number	6 37 21 005 01 9
--------------	------------------

Lamella fleece cylinder

Ø 100 x 100mm



or medium satin finish

Grit	Version	Order number
100	medium	6 37 21 008 01 4

for fine satin finish

Grit	Version	Order number
180	fine	6 37 21 009 01 8

for very fine satin finish

Grit	Version	Order number
280	very fine	6 37 21 010 01 0

Support plate

Ø 115 mm, with hook and loop section, for use with sanding fleece, M14.



Order number	6 38 06 172 01 0
--------------	------------------

Sanding belts

600 x 30mm

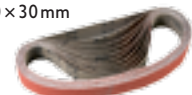

Grit	No. in pack	Order number
60	10	6 37 14 044 01 0
120	10	6 37 14 045 01 4
240	10	6 37 14 046 01 7

Adhesive strip

for re-fastening sanding belts in closed pipe systems, 50 m.

Order number	6 38 09 004 01 9
--------------	------------------

Other accessories

Fleece belts

With button closure for re-fastening, ideal for closed pipe systems, 600 x 30 mm.



Version	Order number
coarse	6 37 14 047 01 1
medium	6 37 14 048 01 9
fine	6 37 14 049 01 3

Polishing rings, sisal

- for
- ▶ fine sanding / brushing and smoothing stainless steel after pre-sanding with Grit 280 – 400 with “yellow” brush paste.
 - ▶ Matt sheen polishing of stainless steel with “yellow” brush paste.
 - ▶ Width approx. 30 mm, bore 14 mm.



Ø mm	Order number
150	6 37 23 011 01 4
200	6 37 23 012 01 7

Polierringe, Tuch, fest

- ▶ Width approx. 15 mm, bore 14 mm.
- ▶ For pre-polishing and polishing stainless steel with “orange” pre-polishing paste.



Ø mm	Order number
150	6 37 23 013 01 1
200	6 37 23 015 01 3

Polishing rings, soft cloth

- ▶ Width approx. 15 mm, bore 14 mm.
- ▶ For high gloss polishing of stainless steel and chrome with “white” colouring paste.

Ø mm	Order number
150	6 37 23 014 01 9
200	6 37 23 016 01 6

Polishing rings, fleece extra soft

- ▶ Width approx. 15 mm, bore 14 mm.
- ▶ For finish polishing of stainless steel with colouring paste.

Ø mm	Order number
150	6 37 23 019 01 2
200	6 37 23 020 01 4

Polishing wheel

- ▶ Ø 150 mm, width 60 mm, elastic
- ▶ For brush polishing, Grit 16 (coarse), soft “green”.



Order number	6 37 13 013 01 8
--------------	------------------

For fine surfaces, Grit 24 (medium), soft “blue”.

Order number	6 37 13 015 01 0
--------------	------------------

For fine polishing, Grit 46 (fine), soft, “brown”.

Order number	6 37 13 016 01 3
--------------	------------------

Requires: Work arbour.

Order number	6 38 03 066 02 4
--------------	------------------

Flap wheel

Width 50 mm, for polishing rust-resistant steel.



Ø mm	Order number
200	6 37 21 001 00 1

Vienna chalk

Stainless steel cleaning powder to remove polishing paste and fingerprints, 1 kg.



Order number	6 37 26 007 01 4
--------------	------------------

Polishing paste

For machining non-ferrous metals, iron/steel and stainless steel.



		Order number
Brush paste	yellow	6 37 26 027 01 0
Pre-polishing paste	orange	6 37 26 028 01 0
Colouring paste	white	6 37 26 029 01 0

Microfibre cloth

Fine weave quality for cleaning polishing residue. Hem-free version means no scratches and no lint.



Order number	6 37 33 003 01 0
--------------	------------------

Holder

For side handle, can be swivelled through 360°.



Order number	6 37 33 006 01 0
--------------	------------------

Work arbour

For satin-finishing tools (cylinders and rollers), length 100 mm, tool holder Ø 19 mm, M14.



Order number	6 38 03 067 02 8
--------------	------------------

Work arbour

For cylinders, length 50 mm, tool mounting diameter 19 mm, M14.



Order number	6 38 03 071 02 0
--------------	------------------

With wheel flange M 14, for polishing rings, holding range 15 – 35 mm.



Order number	6 38 03 027 03 8
--------------	------------------

With wheel flange M 14, for lamella sanding discs, buffing and polishing discs, holding range 15 – 50 mm.



Order number	6 38 03 066 02 4
--------------	------------------

Safety hoop

As hand guard.



Order number	3 02 29 216 00 5
--------------	------------------

Anti-vibration handle

M8, vibration-absorbing, to reduce vibrations during longer jobs.



Order number	3 21 19 124 01 0
--------------	------------------

Sanding belt, Grit 120, pack of 10

For removing minor scratches, intermediate sanding



Order number	6 37 14 045 01 4
--------------	------------------

Sanding belt, Grit 60, pack of 10

For removing deep scratches.



Order number	6 37 14 044 01 0
--------------	------------------

Expansion cylinder

Ø 100 x 100 mm, for vibration-free, secure holding of sanding sleeves.



Order number	6 38 06 192 01 0
--------------	------------------

Sanding sleeve

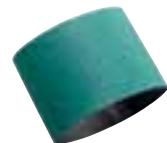

For removing small welded seams and very deep scratches and mill scale

Grit	No. in pack	Order number
60	5	6 37 14 132 01 0

For removing deep scratches

Grit	No. in pack	Order number
80	5	6 37 14 133 01 0

For removing scratches, stage prior to satin-finishing

Grit	No. in pack	Order number
120	5	6 37 14 134 01 0



FEIN Straight grinder MShy 648-1 Z – unbeatable speed stability.

The MShy 648-1 Z is a manoeuvrable and powerful straight grinder that's ideal for use in places with difficult accessibility. Its narrow neck is perfect for hard-to-reach places. It offers good speed stability and is perfectly designed for machining stainless steel, for example satin-finishing and polishing corners and edges. The spindle with multiple bearings makes for quiet operation and therefore accurate working.

Benefits:

- ▶ Ideal speed for working with stainless steel, satin-finishing and polishing corners and edges.
- ▶ Collet for shank up to 8 mm diameter.
- ▶ Small width across corners thanks to offset shape.
- ▶ Narrow neck and handle for ergonomic shape.

High precision

Multiple-bearing spindle ensures quiet operation and therefore precise working.

Long service life

Metal gearbox housing.



Ergonomic shape

Narrow, non-slip neck and handle for a secure grip.

Stable speed

Speed optimised for machining stainless steel. For satin-finishing and polishing corners and edges.

Technical data

Model		MShy 648-1 Z
Power / consumption	w	650
Power / output	w	420
Idling speed	rpm	6000
Cable with plug	m	4
Weight according to EPTA	kg	3.3
Tool holder		
Collet Ø	mm	8
Sanding wheel max. Ø	mm	50

230volt only



MShy 648-1 Z



Powerful straight grinder with optimum speed for stainless steel.

Included in price:
1 set of keys

Order number	7 223 13
--------------	----------

Accessories

Tool case

Metal, 700 × 180 × 100 mm.



Order number	3 39 01 021 01 1
--------------	------------------

Sanding disc

50 × 10 × 13 mm



Version	Order number
NK 24 (A)	6 37 07 008 00 2
SC 24 (C)	6 37 07 009 00 6

Collet

Insertion depth 30 mm.



Ø mm	Order number
3	6 32 07 087 00 1
6	6 32 07 059 00 6
8	6 32 07 069 00 5
1/4	6 32 07 088 00 9

Work arbour

for sanding discs.



Order number	6 38 03 058 01 1
--------------	------------------

FEIN Straight grinder AHSI 636 c – a little gem from FEIN.

Small but highly versatile: with its extremely compact design the AHSI 636 c is the ideal straight grinder for all corners and edges, for example on hand rails. When you have to work in narrow spaces the small width across the corners is simply unbeatable. It's versatile, robust and offers good speed stability. The drill chuck allows you to clamp any kind of tool.

Benefits:

- ▶ Drill chuck with protective cover.
- ▶ Holes in steel up to 4 mm in diameter.
- ▶ Small width across corners thanks to offset shape.
- ▶ Stable speed for brushing and polishing.
- ▶ Tool mounting with gear rim drill chuck up to 10 mm in diameter.



Stable speed

Specially designed for brushing and polishing tools: uncompromising speed stability.

Long service life

Metal gearbox housing.

Ergonomic shape

Small, compact design prevents fatigue.

Drill chuck for flexibility

Tool holder with key-type drill chuck up to Ø 10 mm for using a wide range of tools with shank.

Technical data

Model		AHSI 636 C
Power / consumption	w	280
Power / output	w	150
Idling speed	rpm	5500
Cable with plug	m	3
Weight according to EPTA	kg	1.7
Tool holder		
Sanding wheel max. Ø	mm	50
Drill type chuck	mm	10



AHSI 636 C



Speed-stable straight grinder for brushing and polishing.

Included in price:
1 set of keys

Order number 7 223 02

Accessories

Tool case
Plastic, 450×310×135 mm



Order number 3 39 01 118 01 0

Plastic box



Case insert with lockable lid for small parts and accessories, suitable for tool case 3 39 01 118 01 0, max. 5 per case.

Order number 3 39 01 119 00 0

Work arbour
for sanding discs.



Order number 6 38 03 058 01 1

Work with extreme precision, even where space is tight: with the FEIN fillet weld sander KS 10-38 E.

With the FEIN fillet weld sander, FEIN completes its range of tools for machining stainless steel surfaces. The small, flat and ergonomic tool precisely and quickly machines fillet welds following metallic assembly. You can use it to level, sand and polish as well as remove scratches and unevenness with precision, right into the smallest angles and corners. The speed can always be perfectly adapted to any application and the genuine FEIN accessories deliver perfect results without the need for rework.

Benefits:

- ▶ Flexible use thanks to drive head that can be swivelled without the need for tools.
- ▶ Flat design for corners, angles and difficult-to-reach spots.
- ▶ Electronic speed adjustment.
- ▶ Long belt drive service life thanks to zero-maintenance tensioning system.
- ▶ Made in Germany quality

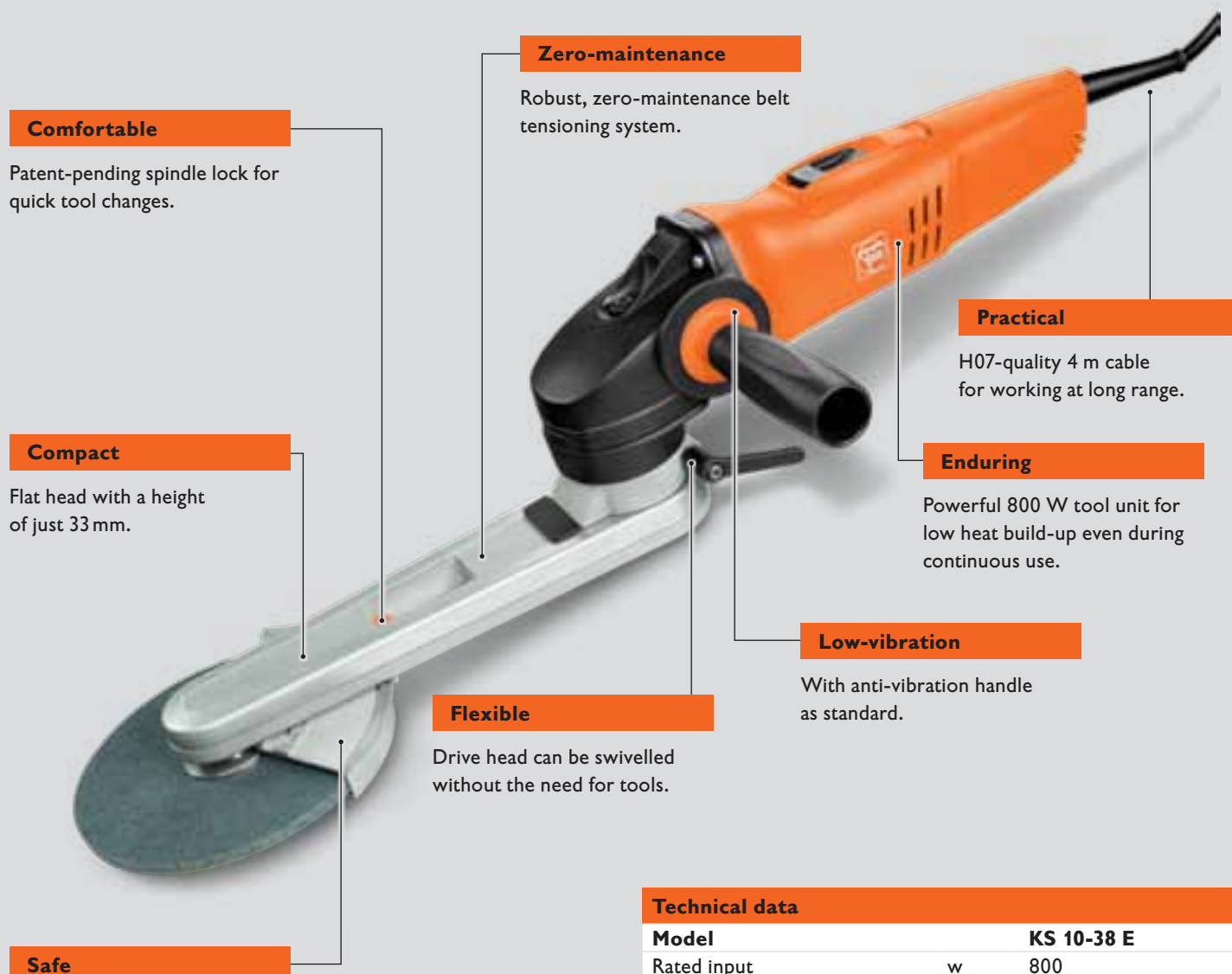

Comfortable

Patent-pending spindle lock for quick tool changes.

Zero-maintenance

Robust, zero-maintenance belt tensioning system.

Compact

Flat head with a height of just 33 mm.

Practical

H07-quality 4 m cable for working at long range.

Enduring

Powerful 800 W tool unit for low heat build-up even during continuous use.

Low-vibration

With anti-vibration handle as standard.

Flexible

Drive head can be swivelled without the need for tools.

Safe

Spark hood can be adjusted and removed without the need for tools.

Technical data

Model		KS 10-38 E
Rated input	w	800
Speed	rpm	1350 – 3750
Max. peripheral speed	m/sec	29.5 (at 3750 rpm)
Weight (EPTA)	kg	3.2
Tool diameter	mm	150



Tarnishing can be quickly removed without damaging neighbouring components by using the (fine) fleece disc.



Sand fillet welds to the desired profile by using the (medium) fleece disc. The profiles of the fleece discs can be changed using a profile stone.



Fillet welds can be polished to a mirror polish using the felt disc and polishing paste.



Thanks to the high plunge depth and the tool's rotatable drive head, you can even work in difficult-to-reach spots.

FEIN fillet weld sander KS 10-38 E set



The basic equipment you'll need for working in difficult-to-reach spots when removing tarnishing from fillet welds, sand fillet welds, level contours and satin-finish.

- ▶ Fillet weld sander KS 10-38 E in plastic case
- ▶ Medium fleece discs, Ø 150mm, one 3 mm thick and one 6 mm thick
- ▶ Fine fleece discs, Ø 150mm, one 3 mm thick and one 6 mm thick
- ▶ Profiling stone for profiling the fleece discs

Order number

7 221 67 60

Accessories

Coarse fleece disc, Ø 150 mm

With a high sanding capacity for sanding, descaling and satin-finishing fillet welds.



Thickness mm	No. in pack	Order number
3	1	6 37 34 001 01 0
6	1	6 37 34 002 01 0

Fine fleece disc, Ø 150 mm

Removes tarnishing and minor scratches, ideal for preparing to polish fillet welds.



Thickness mm	No. in pack	Order number
3	1	6 37 34 005 01 0
6	1	6 37 34 006 01 0

Felt disc, Ø 150 mm

For polishing fillet welds to a mirror polish in conjunction with FEIN polishing paste.



Thickness mm	No. in pack	Order number
6	1	6 37 18 011 01 0

Colouring paste, white

For colouring and high-gloss polishing in conjunction with the felt disc.

Order number

6 37 26 009 01 6

Medium fleece disc, Ø 150 mm

For sanding, levelling, descaling and fine satin-finishing of fillet welds. Removes scratches on profiles and surfaces with ease.



Thickness mm	No. in pack	Order number
3	1	6 37 34 003 01 0
6	1	6 37 34 004 01 0

Very fine fleece disc, Ø 150 mm

For pre-polishing surfaces of fillet welds. Quickly removes tarnishing without wearing away the welded seam.



Thickness mm	No. in pack	Order number
6	1	6 37 34 007 01 0

Profiling stone

For sanding the fleece discs for even fillet weld profiles.



Order number

6 37 19 011 01 0

Vienna chalk

Stainless steel cleaning powder to remove polishing paste and fingerprints, 1 kg.

Order number

6 37 26 007 01 4

Microfibre cloth

Fine weave quality for cleaning polishing residue. Seam-free version means no scratches and no lint.

Order number

6 37 33 003 01 0

Pre-polishing cream, red

For pre-polishing in conjunction with the felt disc.

Order number

6 37 26 008 01 2

Compact, light and ergonomic: the FEIN RS 10-70 E pipe sander.

The pipe sander for all standard uprights and hand rails. Ideal for machining pipes and pipe bends. From cleaning off dirt, removing tarnishing, sanding fine welded seams and satin-finishing to polishing preparations and polishing to a mirror finish. The sander is small and easy to use. It's fitted with a drive head which can swivel almost 360° to enable comfortable use, even in tight spaces. The sander is very flexible and can be variably adapted to different pipe diameters or sanding belts.

Benefits:

- ▶ Simple handling.
- ▶ Reliable belt guidance.
- ▶ Low weight.
- ▶ Continuously adjustable speed.
- ▶ Dustproof ball bearing.

User-friendly

Drive head can be swivelled almost 360°.

Comfortable

Tool-free belt change and automatic belt adjustment.

Powerful

FEIN 800 W high-power motor designed for continuous use.

Variable

The speed range can be set differently for grinding, fleece and polishing belts.

Flexible

Grinding belts can be adjusted to pipe diameters of up to 45 mm.

Technical data

Model	RS 10-70 E	
Power consumption	w	800
Output power	w	550
Belt length	mm	533
Belt width	mm	30
Speed	rpm	2500–7000
Belt speed	m/s	3.5–11
Min. distance from wall	mm	50
Dimensions L × W × H	mm	514 × 143 × 160
Pipe diameter	mm	8–45
Cable length	m	4
Weight according to EPTA	kg	2.9

Saves energy

Clasping angle of up to 180° for an economical sanding result.



FEIN RS 10-70 E starter set



The starter set covers all standard applications for pipes and pipe bends: cleaning, removing tarnishing and scratches, removing welded seams, creating sanding patterns and achieving a high-quality satin finish.

- ▶ Tool in case
- ▶ 10 ceramic sanding belts, grit 120
- ▶ 10 ceramic sanding belts, grit 180
- ▶ 5 fleece belts, fine

Order number

7 221 66 60

RS 10-70 E



Compact pipe sander for pipe bends, pipes and uprights 8 mm - 45 mm in diameter.

Order number 7 221 66 60

Accessories

Grinding belts

Highly flexible sanding belts, ideal for sanding pipe bends.



30 × 533 mm

Grit	No. in pack	Order number
80	10	6 37 14 136 01 0
120	10	6 37 14 137 01 0
180	10	6 37 14 138 01 0
320	10	6 37 14 139 01 0
400	10	6 37 14 140 01 0

Fleece belts

Very soft version for smooth surfaces, even with tight pipe bends.



30 × 533 mm

Version	No. in pack	Order number
coarse	5	6 37 14 141 01 0
medium	5	6 37 14 142 01 0
fine	5	6 37 14 143 01 0

Pre-polishing cream, red

For pre-polishing in conjunction with sanding belts.



Order number 6 37 26 008 01 2

Colouring paste, white

For colouring and high-gloss polishing in conjunction with polishing belts.

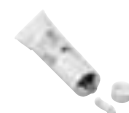

Order number 6 37 26 009 01 6

Vienna chalk



Order number 6 37 26 007 01 4

Polishing belts

30 × 533 mm, very soft version for smooth mirror finish, even with tight pipe bends, 3 in pack.



Order number 6 37 14 144 01 0

Microfibre cloth



Order number 6 37 33 003 01 0

Tool case

Without contents, for RS 10-70 E and KS 10-38 E.



Order number 3 39 01 130 05 0

FEIN Pipe sander RS 12-70 E – the easy way to handle tight curves.

The RS 12-70 E can be easily manoeuvred around tight curves and enables you to rework ready-fitted hand rails. With infinitely variable speed it's ideal for sanding, satin-finishing and high-gloss polishing. It's flexible sanding belts adapt optimally to even the tightest pipe bends.

Benefits:

- ▶ Flexible grinding belts optimally adapt to even tight pipe bends, creating smooth surfaces without awkward transitions.
- ▶ 360° peripheral sanding in just 2 steps.
- ▶ Optional guide pulleys for working close to the wall.
- ▶ Wide range of accessories.
- ▶ Dustproof ball bearings.

Long service life

Metal gearbox, metal sanding arms and dustproof ball bearing.

HIGH-POWER-MOTOR

Effective material removal over the full working range and load of up to 150%.

Optimum cutting speed

- ▶ Effective sanding of welded seams thanks to optimum cutting speeds.
- ▶ Infinitely variable speed for sanding, satin-finishing and high-gloss polishing of ready-fitted hand rails.

Reliable belt guidance

The belts are guided safely by the stepped rollers.

Rapid progress of work

360° peripheral sanding in just 2 steps.

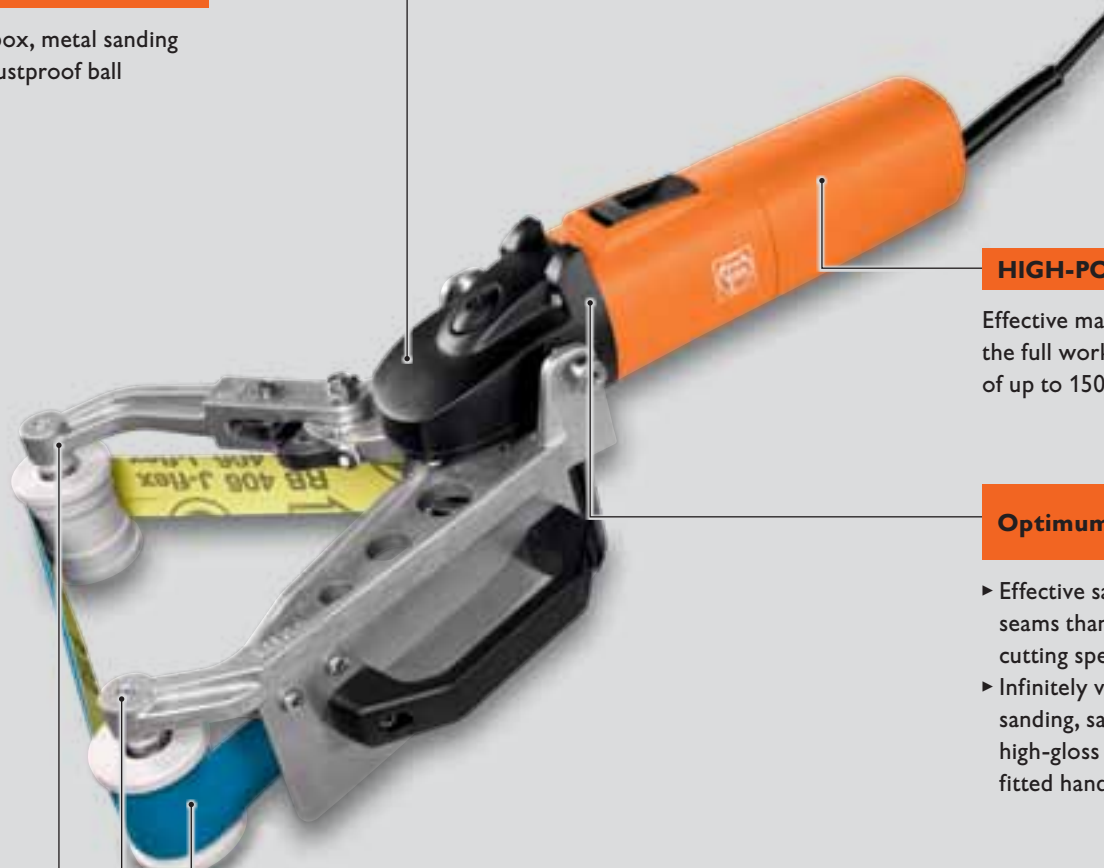

Technical data

Model		RS 12-70 E
Power / consumption	w	1200
Power / output	w	750
Idling speed	rpm	2700–7000
Belt speed	m/sec	22
Minimum distance from wall	mm	50
Weight according to EPTA	kg	3.8
Cable with plug	m	4
Pipes up to Ø	mm	8–80



FEIN RS 12-70 E starter set

The starter set covers all standard applications for pipes and pipe bends: cleaning, removing mill scale and scratches, creating sanding pattern and achieving a high-quality satin finish.

- ▶ 2 x 10 sanding belts 20 x 815 mm P120 / P180
- ▶ 2 x 10 sanding belts 40 x 815 mm P120/P180
- ▶ 5 fleece belts 20 x 820 mm, very fine
- ▶ 1 Tool case

Order number

7 221 13 51



RS 12-70 E



Pipe sander for tight bends with infinitely variable speed for sanding, satin-finishing and high-gloss polishing. Supplied in box without accessories.

Order number 7 221 13 50

Pipe sander sets

Basic pipe sander set

Cleaning off dirt, removing scratches and achieving a perfect satin finish

- Also included:
- 2 x 10 sanding belts, 20 x 815 mm, P 120 / P180
 - 2 x 10 sanding belts, 40 x 815 mm, P 120 / P180
 - 5 fleece belts, 20 x 820 mm, fine 280



Order number 6 37 14 050 02 1

Pipe sander polishing set

From preparing to polish to achieving a perfect mirror polish

- Also included:
- 2 x 10 sanding belts, 20 x 815 mm, P 320 / P400
 - 1 x 3 polishing belts, 20 x 815 mm
 - 1 tube pre-polishing cream, red (200 ml)
 - 1 tube colouring paste, white (200 ml)



Order number 6 37 14 052 02 3

Accessories

Ceramic sanding belts

Maximum material removal and very long service life. Also suitable for removing fine welded seams.

Maße	No. in pack	Order number
20 x 815 mm	10	6 37 14 130 01 0
40 x 815 mm	10	6 37 14 131 01 0

Sanding belts

Highly flexible sanding belts, ideal for sanding pipe bends.



20 x 815 mm

Grit	No. in pack	Order number
120	10	6 37 14 050 01 5
180	10	6 37 14 051 01 4
320	10	6 37 14 052 01 7
400	10	6 37 14 053 01 1

40 x 815 mm

Grit	No. in pack	Order number
120	10	6 37 14 054 01 9
180	10	6 37 14 055 01 3

Polishing belts, pack of 3

Very soft version, for smooth mirror polish even with tight pipe bends.



20 x 815 mm

Version	No. in pack	Order number
coarse	5	6 37 14 056 01 6
medium	5	6 37 14 057 01 0
fine	5	6 37 14 058 01 8

Polishing belts

20 x 815 mm, very soft version, for smooth mirror polish even with tight pipe bends, 3 in pack.



Order number 6 37 26 010 01 8

Pre-polishing cream, red

For pre-polishing in conjunction with polishing belts.



Order number 6 37 26 008 01 2

Colouring paste, white

For colouring and high-gloss polishing in conjunction with polishing belts.



Order number 6 37 26 009 01 6

Stepped guide roller for RS 12-70 E

Two rollers are required for conversion. Supplied without ball bearings. Pack of 1.



Order number 3 13 35 019 01 0

Ball bearing

For guide rollers RS12-70 E. Pack of 1.

Order number 4 17 01 004 03 7

Guide pulley

For narrow spaces (distance from wall 50 mm). Pulleys with ball bearings. Pack of 2.



Order number 3 13 35 017 01 1

Vienna chalk



Order number 6 37 26 007 01 4

Microfibre cloth



Order number 6 37 33 003 01 0



Small, easy to operate and incredibly powerful: the FEIN BF 10-280 E belt sander.

Whether you're smoothing edges, deburring sheet metal or sanding welded seams, professional surface finishing needs to be flexible yet economic. You need tools which deliver perfect results even in tight spaces or on workpieces which are already in place.

The new powerful FEIN BF 10-280 E makes light work of the numerous demands made of it. It is impressively easy to use, delivers incredible power and enjoys a long life.

Benefits:

- ▶ Maximum material removal in the tightest of spaces.
- ▶ Maximum plunge depth in workpiece of up to 165 mm.
- ▶ For belt widths of between 3 and 20 mm.
- ▶ Ideal for constructions which are already fitted, such as hand rails etc.
- ▶ Reliable belt guidance even with narrow belts.

Efficient

Gearbox designed for optimum belt speeds.

User-friendly

Drive head can be swivelled 180° without the need for tools.

Comfortable

Easy to operate without an additional handle. Even comfortable for continuous use.

Variable

The speed range can be set differently for grinding, fleece and polishing belts.

Powerful

FEIN 800 W high-power motor designed for continuous use.

Safe

Even narrow grinding belts (3mm wide) remain in the guide.



Technical data

Model		BF 10-280 E
Rated input	w	800
Output power	w	550
Belt length	mm	520
Belt width	mm	3 / 6 / 20
Speed	rpm	10 000 – 28 000
Belt speed	m / s	12 – 32
Weight according to EPTA	kg	2.1
Cable	m	4
Dimensions L x W x H	mm	522 x 118 x 69
Plunge depth	mm	165



FEIN BF 10-280 E starter set



The FEIN BF 10-280 E starter set equips you for all important applications when machining corners, edges, pipes and profiles. Perfectly matched accessories are available for special tasks.

- ▶ 1 BF 10-280 E tool in plastic case
- ▶ 3 grinding arms (1 each of 3/6 mm stepped, 6 mm straight, 20 mm straight)
- ▶ 10 grinding belts 3 mm, grit 120
- ▶ 10 grinding belts 6 mm, grit 120
- ▶ 10 grinding belts 20 mm, grit 120)
- ▶ 5 fleece belts 6 mm (medium)

BF 10-280 E



Powerful belt sander for flexible use. Drive head can be swivelled 180° without the need for tools. Supplied in box without accessories.

Order number 7 228 05 50

Accessories

Ceramic grinding belt

Maximum material removal and very long service life. Also suitable for removing fine welded seams, 10 in pack.



Width x Length		
mm	Grit	Order number
3 x 520	80	6 37 14 061 01 0
3 x 520	120	6 37 14 062 01 0
3 x 520	180	6 37 14 063 01 0
6 x 520	80	6 37 14 068 01 0
6 x 520	120	6 37 14 069 01 0
6 x 520	180	6 37 14 070 01 0
20 x 520	80	6 37 14 089 01 0
20 x 520	120	6 37 14 090 01 0
20 x 520	180	6 37 14 091 01 0

Polishing belt

Soft version for smooth mirror polish. 3 in pack.



Width x Length	
mm	Order number
6 x 520	6 37 26 016 01 0
20 x 520	6 37 26 019 01 0

Fleece belt

Soft version for smooth surfaces. 5 in pack.



Width x Length		
mm	Version	Order number
6 x 520	coarse	6 37 14 114 01 0
6 x 520	medium	6 37 14 115 01 0
6 x 520	fine	6 37 14 116 01 0
20 x 520	coarse	6 37 14 123 01 0
20 x 520	medium	6 37 14 124 01 0
20 x 520	fine	6 37 14 125 01 0

Stepped grinding arm



Width mm	Order number
3/6	6 38 10 026 01 0

Straight grinding arm

1 in pack



Width mm	Order number
6	6 38 10 027 01 0
20	6 38 10 030 01 0

Pre-polishing cream, red

For pre-polishing in conjunction with polishing belts.

Order number 6 37 26 008 01 2

Colouring paste, white

For colouring and high-gloss polishing in conjunction with polishing belts.

Order number 6 37 26 009 01 6

Vienna chalk

Stainless steel cleaning powder to remove polishing paste and fingerprints, 1 kg.

Order number 6 37 26 007 01 4

Microfibre cloth

Fine weave quality for cleaning polishing residue. Seam-free version means no scratches and no lint.

Order number 6 37 33 003 01 0

FEIN GRIT belt grinders – one system, a wealth of possibilities.

Developing solutions to metal machining problems is one of FEIN's core competencies. GRIT has been setting the standard in belt grinders for 25 years. In acquiring the GRIT brand, FEIN is continuing to expand its expertise in this area. Users benefit from the combined know-how of two leading brand-name manufacturers. GRIT by FEIN stands for belt grinders that are optimally adapted to your application. There are two GRIT systems to satisfy all requirements: GRIT GX for use in the workshop and the exceptionally powerful

and heavy-duty GRIT GI system for industrial use. Both GRIT systems are based on the unique, modular 'building block' concept. The benefits: powerful basic belt grinders and add-on modules for specific applications, covering every imaginable task in manual trades and industry.



GRIT GX – for use in the workshop.

Belt grinder GRIT GX 75 2H

Belt grinder (basic unit)



GX 75 2H

7 901 02

Radius grinder GRIT GX 75 2H + GRIT GXR

Radius grinder



Belt grinder (basic unit)



GX 75 2H

7 901 02



Radius grinding module



GXR 9 90 01 001 00 0

Centreless grinder GRIT GX 75 2H + GRIT GXC + GRIT GXW

Centreless grinder



Belt grinder (basic unit)



GX 75 2H

7 901 02



Rotary grinding



GXC

7 901 03



Cooling lubricant module



GXW

7 901 04

Deburring machine GRIT GXE + GRIT GIXS / GIXBE

Deburring machine



Deburring machine (basic unit)



GXE

7 901 05



Machine base



GIXS 9 90 01 002 00 0

GIXBE 9 90 01 009 00 0

Belt grinder GRIT GX 75 2H.

The powerful belt grinder in the two-speed version is the basis of the modular GX range and can also be used on its own as a fully functional belt grinder. The two-speed feature makes it ideal for machining stainless steel. Using the various add-on modules, you can convert your basic machine into a radius or centreless grinder in a few quick steps.

Benefits:

- ▶ Effective material removal in a short space of time.
- ▶ Accurate working thanks to patented belt tensioning system.
- ▶ Highly cost-effective as no special machinery is required.
- ▶ Can also be used on its own without add-on modules.

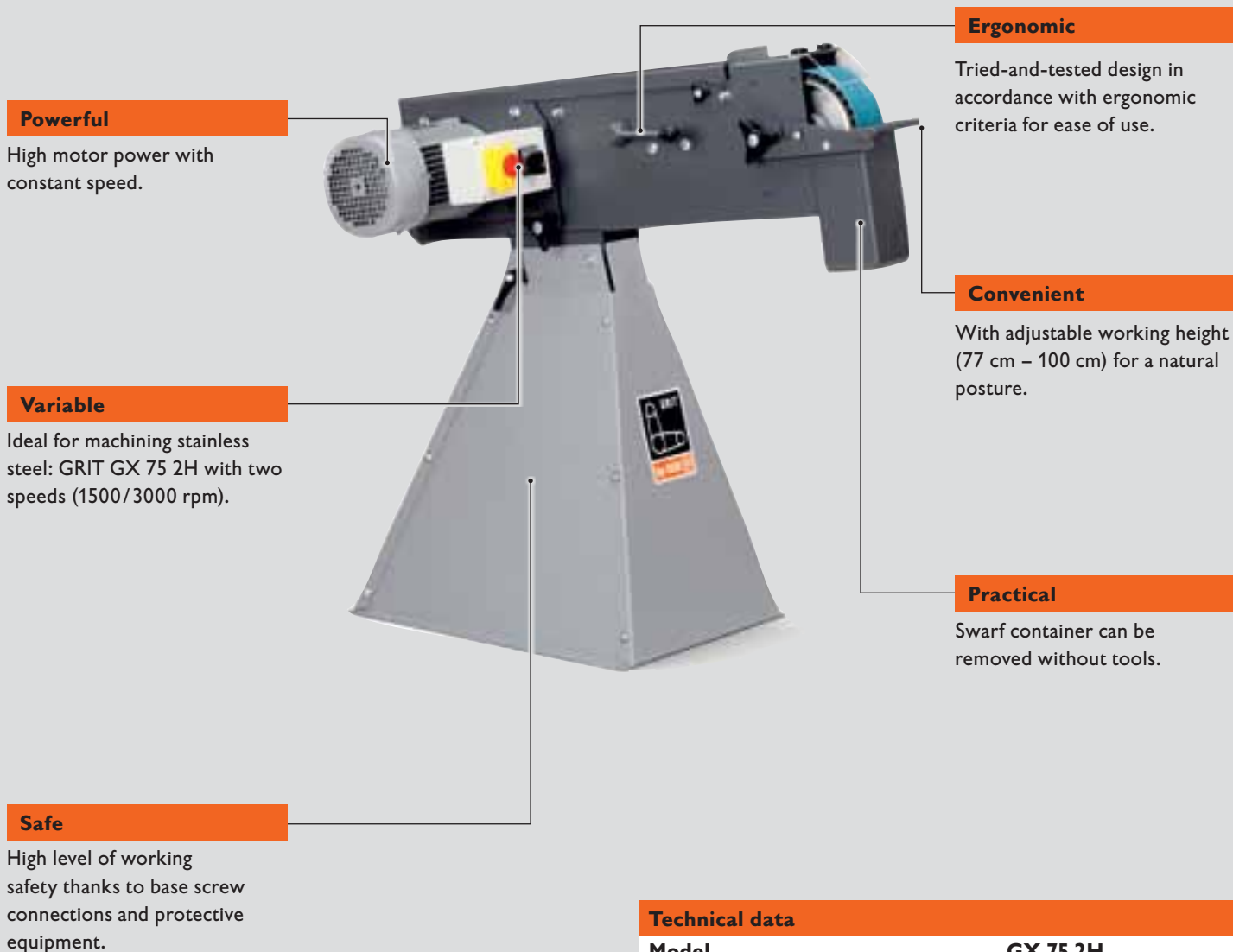

Powerful

High motor power with constant speed.

Variable

Ideal for machining stainless steel: GRIT GX 75 2H with two speeds (1500/3000 rpm).

Safe

High level of working safety thanks to base screw connections and protective equipment.

Ergonomic

Tried-and-tested design in accordance with ergonomic criteria for ease of use.

Convenient

With adjustable working height (77 cm – 100 cm) for a natural posture.

Practical

Swarf container can be removed without tools.

Technical data

Model	GX 75 2H	
Power / consumption	kW	1.5/2.0
Idling speed	rpm	1500/3000
Belt speed	m/s	15/30
Belt dimensions	mm	75 × 2 000
Weight according to EPTA	kg	75



Belt grinder

GRIT GX 75 2H



Universal belt grinder, can be expanded through the use of modules, for metalworking manual trades, ideal for machining stainless steel in small-scale volume production.

Order number 7 901 02

Add-on module

Radius grinding module GXR

Radius grinding module for accurate grinding of pipes and profiles for handrail construction. In a few simple steps, the addition of the GXR module transforms the GX 75 2H belt grinder into a professional radius grinder equipped as standard with depth stop, cross slide and quick clamping system. This makes precise grinding not only straightforward but also much more comfortable.



Technical data

Model	GXR	
Pipes up to Ø	mm	16–75
Dimensions of profiles/flat material max.	mm	75 × 75
Belt dimensions	mm	75 × 2250
Weight according to EPTA	kg	54
Order number	9 90 01 001 00 0	

Centreless grinding module GXC

Centreless grinding module for perfect surfaces on stainless steel pipes. The GXC centreless grinding module also offers excellent efficiency and flexibility when it comes to grinding the outside of pipes in automated production lines. It allows you to achieve perfect surfaces with minimal effort.



Technical data

Model	GXC	
Power / consumption	kW	0,18
Pipes up to Ø	mm	10–100
Belt dimensions	mm	75 × 2000
Variable feed	m/min	0–2
Weight according to EPTA	kg	48
Order number	7 901 03	

Cooling lubricant module GXW

In combination with the GXC, significantly reduces heat build-up while binding swarf.



Technical data

Model	GXW	
Power / consumption kW	0.12	
Weight according to EPTA	kg	8.6
Order number	7 901 04	

Deburring machine GXE

Effective deburring machine for small-scale volume production. The GXE deburring machine takes care of the last step in the process. It's extremely effective at deburring pipes, profiles and flat materials.



Technical data

Model	GXE	
Power / consumption kW	2.2	
Idling speed	rpm	1500
Tool dimensions max. Ø x width	mm	250 × 60
Weight according to EPTA	kg	32
Order number	7 901 05	

Machine bases GIXS / GIXBE

Both machine bases, either with or without dust extraction, are ideal for the GXE deburring machine.



Technical data

Model	GIXS	
Dimensions	mm	304 × 356 × 769
Weight according to EPTA	kg	18
Order number	9 90 01 002 00 0	

Technical data

Model	GIXBE	
Power	kW	0.37
Max. vacuum	mbar	2.65
Dimensions	mm	305 × 575 × 700
Weight according to EPTA	kg	58
Order number	9 90 01 009 00 0	

GRIT GX – ACCESSORIES

GRIT GX 75 2H accessories

Graphite coating

As sliding base for surface grinding, 5 in pack.

Order number 3 90 00 000 00 1

Contact wheel

Hardness, 80 shore.

Order number 3 90 00 000 00 5

Eye guard

Acrylic glass plate for protection against flying sparks, 3 in pack.



Order number 3 90 00 000 00 4

GRIT GXR accessories

Stainless steel clamping jaw

Interchangeable, for vice when machining stainless steel, 1 in pack



Order number 6 99 02 004 00 0

Length stop

1000 mm long, continuously variable, easy to fit.



Order number 6 99 02 001 00 0

Contact rollers

Easy to fit, ball bearings on both sides.



Ø mm	Order number
16.0	6 99 02 020 00 0
17.0	6 99 02 021 00 0
17.2	6 99 02 022 00 0
18.0	6 99 02 023 00 0
19.0	6 99 02 024 00 0
20.0	6 99 02 025 00 0
21.0	6 99 02 026 00 0
21.3	6 99 02 027 00 0
22.0	6 99 02 028 00 0
22.2	6 99 02 029 00 0
22.5	6 99 02 030 00 0
23.0	6 99 02 031 00 0
23.1	6 99 02 032 00 0
24.0	6 99 02 033 00 0
24.5	6 99 02 034 00 0
25.0	6 99 02 035 00 0

25.4	6 99 02 036 00 0
25.9	6 99 02 037 00 0
26.0	6 99 02 038 00 0
26.4	6 99 02 039 00 0
26.9	6 99 02 040 00 0
27.0	6 99 02 041 00 0
28.0	6 99 02 042 00 0
28.6	6 99 02 043 00 0
28.8	6 99 02 044 00 0
29.0	6 99 02 045 00 0
30.0	6 99 02 046 00 0
31.7	6 99 02 047 00 0
32.0	6 99 02 048 00 0
33.0	6 99 02 049 00 0
33.7	6 99 02 050 00 0
34.0	6 99 02 051 00 0
35.0	6 99 02 052 00 0
36.0	6 99 02 053 00 0
37.5	6 99 02 054 00 0
38.0	6 99 02 055 00 0
38.1	6 99 02 056 00 0
38.3	6 99 02 057 00 0
40.0	6 99 02 058 00 0
41.0	6 99 02 059 00 0
41.2	6 99 02 060 00 0
42.0	6 99 02 061 00 0
42.4	6 99 02 062 00 0
42.6	6 99 02 063 00 0
43.0	6 99 02 064 00 0
43.3	6 99 02 065 00 0
44.0	6 99 02 066 00 0
44.5	6 99 02 067 00 0
45.0	6 99 02 068 00 0
46.0	6 99 02 069 00 0
48.0	6 99 02 070 00 0
48.3	6 99 02 071 00 0
49.0	6 99 02 072 00 0
50.0	6 99 02 073 00 0
50.8	6 99 02 074 00 0
51.0	6 99 02 075 00 0
53.0	6 99 02 076 00 0
53.7	6 99 02 077 00 0
54.0	6 99 02 078 00 0
55.0	6 99 02 079 00 0
57.0	6 99 02 080 00 0
58.0	6 99 02 081 00 0
59.0	6 99 02 082 00 0
60.0	6 99 02 083 00 0
60.3	6 99 02 084 00 0
63.0	6 99 02 085 00 0
63.5	6 99 02 086 00 0
65.0	6 99 02 087 00 0
67.0	6 99 02 088 00 0
69.0	6 99 02 089 00 0
70.0	6 99 02 090 00 0
73.0	6 99 02 091 00 0
75.0	6 99 02 092 00 0
76.0	6 99 02 093 00 0
76.1	6 99 02 094 00 0
76.2	6 99 02 095 00 0
80.0	6 99 02 096 00 0
82.5	6 99 02 097 00 0
88.9	6 99 02 098 00 0
90.0	6 99 02 099 00 0

GRIT GXR accessories

Eye guard

Acrylic glass plate for protection against flying sparks, 3 in pack.



Order number 3 90 00 000 00 7

Water container

Plastic, for extinguishing sparks, with handles on the sides, capacity approx. 20 l.



Order number 3 90 00 000 48 5

Connecting piece

Required to adapt the GRIT GXR module to a belt grinder in the GRIT GI range.

Order number 6 99 02 186 00 0

GRIT GXC accessories

Guide rail, brass

For dry grinding and coarse material surfaces.

Order number 3 90 00 000 49 6

Guide rail, nylon

For high surface quality

Order number 3 90 00 000 49 7

Connecting piece

Required to adapt the GRIT GXC module to a belt grinder in the GRIT GI range.

Order number 6 99 02 187 00 0

GRIT GXE accessories

Stainless steel brush

250 x 60 mm in diameter, with very high wire tensile strength for highly cost-effective use, mounting hole diameter 51 mm.



Wire thickness mm	Order number
0.20	6 99 02 009 00 0
0.35	6 99 02 010 00 0

Eye guard

Acrylic glass plate for protection against flying sparks, 3 in pack.

Order number 3 90 00 000 00 4

GRIT GXW accessories

Cooling lubricant emulsion

Concentrate, 10 l, mixing ratio 1:30, yields 300 l of ready-to-use cooling lubricant.

Order number 6 99 02 100 00 0

Other GRIT GX accessories

Flexible hose

For swarf extraction, 90 mm in diameter, 1 m long, steel, high level of heat resistance.



Order number 3 90 00 000 00 2

Tensioning belt

For securing the flexible hose.

Order number 3 90 00 000 00 3

Dust container

For extinguishing sparks, metal lid for hose connection, plastic, handles on the sides, capacity approx. 20 l.





Order number 6 99 02 000 00 0

Abrasive material see page 51

GRIT GI – for industrial use.

Belt grinder GRIT GI 75 2H/GI 150 2H + GRIT GIB/GIBE

<p>Belt grinder</p> 	<p>=</p>	<p>Belt grinder (basic unit)</p> 	<p>+</p>	<p>Machine base</p> 
		<p>GI 75 2H 7 902 02 GI 150 2H 7 902 05</p>		<p>GIB 9 90 01 003 00 0 GIBE 9 90 01 004 00 0</p>

Radius grinder GRIT GI 150 2H + GRIT GIB/GIBE + GRIT GIR

<p>Radius grinder</p> 	<p>=</p>	<p>Belt grinder (basic unit)</p> 	<p>+</p>	<p>Machine base</p> 	<p>+</p>	<p>Radius grinding module</p> 
		<p>GI 150 2H 7 902 05</p>		<p>GIB 9 90 01 003 00 0 GIBE 9 90 01 004 00 0</p>		<p>GIR 9 90 01 007 00 0</p>

Longitudinal grinder GRIT GI 150 2H + GRIT GIB/GIBE + GRIT GIL

<p>Longitudinal grinder</p> 	<p>=</p>	<p>Belt grinder (basic unit)</p> 	<p>+</p>	<p>Machine base</p> 	<p>+</p>	<p>Longitudinal grinding module</p> 
		<p>GI 150 2H 7 902 05</p>		<p>GIB 9 90 01 003 00 0 GIBE 9 90 01 004 00 0</p>		<p>GIL 7 902 08</p>

Centreless grinder GRIT GI 75 2H/GI 150 2H + GRIT GIB + GRIT GIC + GRIT GXW

<p>Centreless grinder</p> 	<p>=</p>	<p>Belt grinder (basic unit)</p> 	<p>+</p>	<p>Machine base</p> 	<p>+</p>	<p>Rotary grinding</p> 	<p>+</p>	<p>Cooling lubricant module</p> 
		<p>GI 75 2H 7 902 02 GI 150 2H 7 902 05</p>		<p>GIB 9 90 01 003 00 0</p>		<p>GIC 7 902 12</p>		<p>GXW 7 901 04</p>

Deburring machine GRIT GIE + GRIT GIXS/GIXBE

<p>Deburring machine</p> 	<p>=</p>	<p>Deburring machine (basic unit)</p> 	<p>+</p>	<p>Machine base</p> 
		<p>GIE 7 902 07</p>		<p>GIXS 9 90 01 002 00 0 GIXBE 9 90 01 009 00 0</p>

Belt grinders

GRIT GI 75 2H / GI 150 2H.

The basic equipment for industrial belt grinding: GRIT GI belt grinders. Every component is specially designed to cope with tough professional use while the exceedingly powerful motor keeps the speed constant and delivers high cutting power. GRIT GI belt grinders are available in widths of 75 mm and 150 mm and in a two-speed version. Specially designed for machining stainless steel.

- Benefits:**
- ▶ Reliable in use at all times, even under the toughest conditions.
 - ▶ Easy to convert to a radius, centreless or surface grinder.
 - ▶ Optional extraction system connection for clean working.
 - ▶ S1 motors for continuous use.

Flexible

Can be adjusted for continuous linear grinding.

Powerful

Constant speed and high cutting power, even in continuous use.

Variable

Available with 2 speeds and different belt widths (75 mm or 150 mm).



Safe

Stop, safety gap and individually adjustable eye guard.

Ergonomic

Adjustable working height (77 cm – 100 cm), height-adjustable support.

Convenient

Low-vibration, patented belt tensioning system.

Technical data			
Model		GI 75 2H	GI 150 2H
Power / consumption	kW	2.6 – 3.1	2.6 – 3.1
Idling speed	rpm	1500 / 3000	1500 / 3000
Belt speed	m/s	15 / 30	15 / 30
Belt dimensions	mm	75 × 2000	150 × 2000
Weight according to EPTA	kg	65	82



Belt grinders



Universal high-torque belt grinder, can be expanded through the use of modules, for industrial and volume production applications, ideal for machining stainless steel.

Order number

GI 75 2H	7 902 02
GI 150 2H	7 902 05

Machine bases GIB/GIBE



Machine base without dust extraction.

Order number 9 90 01 003 00 0



Machine base with dust extraction.

Order number 9 90 01 004 00 0

Add-on modules

Radius grinding module GIR

Radius grinding module for accurate grinding on pipes and profiles in volume production applications – also suitable for extra-wide cross-sections. Optimised for industrial use.



Technical data

Model	GIR
Pipes up to Ø	mm 20 – 150
Dimensions of profiles / flat material max.	mm 120 × 150
Belt dimensions	mm 150 × 2250
Weight according to EPTA	kg 109
Order number	9 90 01 007 00 0

Centreless grinding module GIC

Centreless grinding module for industrial centreless grinding in volume production. Suitable for all centreless grinding tasks, such as finish grinding on straight pipes and round materials.



Technical data

Model	GIC
Pipes up to Ø	mm 10 – 130
Belt dimensions	mm 75 × 2000 150 × 2000
Weight according to EPTA	kg 65
Variable feed	m/min 0-2
Order number	7 902 12

Longitudinal grinding module GIL

Surface grinding module for perfect longitudinal grinding of square pipes, profiles and flat materials in automated production. The indispensable tool for machine and handrail construction and welded structures: it is the only system on the market to feature automated infeed for longitudinal grinding.



Technical data

Model	GIL
Power / consumption	kW 0.18
Dimensions of profiles / flat material max.	mm 100 × 100
Belt dimensions	mm 150 × 2000
Weight according to EPTA	kg 64
Order number	7 902 08

Deburring machine GIE

Extremely effective deburring machine for deburring extra-wide workpieces in industrial volume production. The GIE deburrs stainless steel workpieces quickly and effectively. The robust design and powerful drive make this machine ideal for industrial use.



Technical data

Model	GIE
Power / consumption	kW 1.5/2.0
Speed	rpm 1500/3000
Tool width	mm 2 × 60
Max. tool diameter	mm 250
Weight according to EPTA	kg 34
Order number	7 902 07

Deburring machine GIE

**Machine bases
GIXS/GIXBE**

Both machine bases, either with or without dust extraction, are ideal for the deburring machine GIE. Quick to fit, built to last and extremely stable.

Machine base without dust extraction Machine base with dust extraction



Technical data	
Model	GIXS
Dimensions	mm 304x356x769
Weight according to EPTA	kg 18
Order number	9 90 01 002 00 0

Technical data	
Model	GIXBE
Power	kW 0.77
Max. vacuum	mbar 2.65
Dimensions	mm 305x575x700
Weight according to EPTA	kg 58
Order number	9 90 01 009 00 0

GIR accessories

Contact rollers

Long service lives, low roll resistance thanks to high-quality ball bearings, easy to interchange.



Ø mm	Order number
20.0	6 99 02 101 00 0
22.0	6 99 02 102 00 0
25.0	6 99 02 103 00 0
25.4	6 99 02 104 00 0
26.9	6 99 02 105 00 0
28.0	6 99 02 106 00 0
30.0	6 99 02 107 00 0
32.0	6 99 02 108 00 0
33.7	6 99 02 109 00 0
35.0	6 99 02 110 00 0
38.0	6 99 02 111 00 0
38.1	6 99 02 112 00 0
38.3	6 99 02 113 00 0
40.0	6 99 02 114 00 0
42.4	6 99 02 115 00 0
44.5	6 99 02 116 00 0

48.3	6 99 02 117 00 0
50.0	6 99 02 118 00 0
50.8	6 99 02 119 00 0
60.0	6 99 02 120 00 0
60.3	6 99 02 121 00 0
63.5	6 99 02 122 00 0
69.0	6 99 02 123 00 0
76.1	6 99 02 124 00 0
76.2	6 99 02 125 00 0
84.0	6 99 02 126 00 0
88.9	6 99 02 127 00 0
101.6	6 99 02 128 00 0
104.0	6 99 02 129 00 0
108.0	6 99 02 130 00 0
114.3	6 99 02 131 00 0
133.0	6 99 02 132 00 0
139.7	6 99 02 133 00 0
168.3	6 99 02 134 00 0
193.7	6 99 02 135 00 0

Mitre joint grinding plate GIG

For precision mitre joint grinding, easy assembly. Max. pipe Ø: 0° – Ø 110 mm, 30° – Ø 80 mm, 45° – Ø 60 mm

Order number	6 99 02 175 00 0
--------------	------------------

Suction nozzle

For optimum dust extraction, for connection to the GIBE machine base with double extraction.



Order number	6 99 02 182 00 0
--------------	------------------

Eye guard

Acrylic glass plate for protection against flying sparks, 3 in pack.



Order number	3 90 00 000 18 4
--------------	------------------

GIC accessories

Pipe guide set



Set	Pipe length	Order number
1	up to 1500mm	6 99 02 179 50 1
2	up to 3000mm	6 99 02 179 50 2
3	up to 6000mm	6 99 02 179 50 3

Pipe cleaning unit

For a clean and dry working environment. The coolant is wiped off the pipe surface without the pipe being scratched. For pipes with a diameter of between 10 and 130 mm. Easy to fit on GIC.



Order number	6 99 02 000 14 6
--------------	------------------

Drilling template

For installation on belt grinders GRIT GI 75 2H from before the 1034026 series. For producing threaded holes on these belt grinders at a later date.

Order number	3 90 00 004 55 4
--------------	------------------

Guide rail, brass

For dry grinding and coarse material surfaces.



Order number	3 90 00 000 49 6
--------------	------------------

Guide rail, nylon

For high surface quality.



Order number	3 90 00 000 49 7
--------------	------------------

Cooling lubricant emulsion

Concentrate, 10 l, mixing ratio 1:30, yields 300 l of ready-to-use cooling lubricant.

Order number	6 99 02 100 00 0
--------------	------------------

GIL accessories

GIT swivel joint

For adapting working area to tight spaces, infinitely variable swivelling range of up to 90°.

Order number	6 99 02 176 00 0
--------------	------------------

Accessories GIE

Stainless steel brush

Ø 250 mm x 60 mm, with very high wire drawing strength for highly efficient use, mounting hole Ø 51 mm.

0.2 mm-thick wire for thin-walled pipes and profiles. 0.35 mm-thick wire for universal use.



Wire thickness mm	Order number
0.20	6 99 02 009 00 0
0.35	6 99 02 010 00 0

Accessories GIBE/GIXBE

Cartridge filter

Fits GIBE

Order number	3 90 00 000 97 6
--------------	------------------

Cartridge filter

Fits GIXBE

Order number	3 90 00 001 00 5
--------------	------------------



General accessories

GRIT grinding material R

The top grinding belt on the market. Achieves much shorter working times and has superior service life and performance. Especially recommended for machining stainless and high-alloy steels. Extra heavy polyester fabric, fully bonded with artificial resins, with zirconium corundum. Additional top layer for cooling during grinding. Please refer to the table below for order numbers.



75 × 2000

Grit	No. in pack	Order number
24	10	6 99 03 000 00 0
36	10	6 99 03 002 00 0
40	10	6 99 03 004 00 0
60	10	6 99 03 007 00 0
80	10	6 99 03 009 00 0
120	10	6 99 03 013 00 0

75 × 2250

Grit	No. in pack	Order number
36	10	6 99 03 020 00 0

150 × 2000

Grit	No. in pack	Order number
24	10	6 99 03 039 00 0
36	10	6 99 03 040 00 0
40	10	6 99 03 042 00 0
60	10	6 99 03 044 00 0
80	10	6 99 03 046 00 0
120	10	6 99 03 048 00 0

150 × 2250

Grit	No. in pack	Order number
36	10	6 99 03 053 00 0

Fleece belts for GRIT machines

Reliable for everything from covering up minor mistakes to creating a perfect finish. Long service lives make for cost-effective working. Suitable for GRIT GX 75 2H, GXC, GI 75 2H, GI 150 2H, GIC and GIL. Also suited to wet grinding.



75 × 2000

Version	No. in pack	Order number
very fine (blue)	3	6 99 03 121 01 0
medium (red)	3	6 99 03 119 01 0
coarse (brown)	3	6 99 03 117 01 0

150 × 2000

Version	No. in pack	Order number
very fine (blue)	3	6 99 03 120 01 0
medium (red)	3	6 99 03 118 01 0
coarse (brown)	3	6 99 03 116 01 0

GRIT grinding material A

Grinding belts with fine Grit for fine sanding of metals to final finish. Optimum surface results. Heavy cotton fabric, fully bonded with artificial resins, with corundum. Please refer to the table below for order numbers.



75 × 2000

Grit	No. in pack	Order number
220	10	6 99 03 017 00 0
320	10	6 99 03 018 00 0
400	10	6 99 03 019 00 0

GRIT grinding material S

Satin grinding belts with cork granulate for typical satin finishing, Grit 220. Fully bonded with artificial resins, waterproof cotton fabric, elastic cork granulate for best surface results.



75 × 2000

Grit	No. in pack	Order number
220	10	6 99 03 113 00 0

150 × 2000

Grit	No. in pack	Order number
220	10	6 99 03 115 00 0

**FEIN. Unverwüstliche
Elektrowerkzeuge.**



FEIN – the specialist for durable power tools.

FEIN is the specialist for professional and extremely reliable power tools and special application solutions in metalworking, interior fitting and the automotive sector. As the inventor of the electric hand drill, FEIN has been developing innovative and unbeatably efficient solutions for everyday use which can also stand up to the toughest continuous use in industry and trade for over 140 years.



Make the most of the 3-year FEIN PLUS warranty

We offer the 3-year FEIN PLUS warranty for all your FEIN power tools. All you need to do is register your new FEIN power tool at www.fein.com within 6 weeks of purchase.

Do you have any further questions? Your specialist dealer will be happy to help:

DE: C. & E. FEIN GmbH, Telefon 07173 183-0, www.fein.com

UK: FEIN Industrial Power Tools UK Ltd., Phone 01327 308730, www.fein-uk.co.uk

Asia: FEIN Power Tools Asia Limited, A1, Phone 2341-1026, www.fein.hk

AU: FEIN Power Tools Pty. Ltd., Phone 1300 798 688, www.fein.com.au

IN: FEIN Power Tools India Pvt. Ltd., Phone 044-43 578 680, www.fein.in