

► METAL

FEIN. Unverwüstliche
Elektrowerkzeuge.



Faster core drilling. In metal, in any situation.

FEIN core drills KBU and KBH – powerful and universal tools for efficient metal drilling.



Get to the core of the matter faster.

With more precision, economy and speed than ever before, FEIN core drills deliver the best results in the shortest time. The compact, powerful and universal FEIN core drills reduce effort to a minimum, because as well as requiring no pre-drilling or retooling, they also offer rapid work progress. And because FEIN core drill bits have a smaller machining surface, the feed force is minimal – saving time, energy and money.

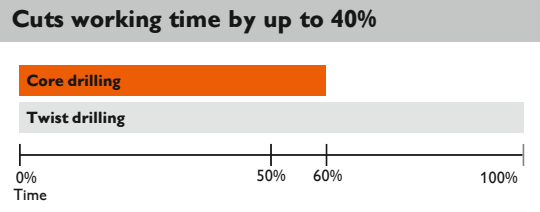

Twist drilling

- ▶ Centre
- ▶ Pre-drill
- ▶ Tool change
- ▶ Finish drilling



π



π

Core drilling

- ▶ Core drilling does all this in a single process.



Cross-section

View from above

F = force

Efficiency means achieving maximum results with minimum effort – which perfectly describes FEIN core drills. Unlike conventional twist drilling, core drilling only involves machining a narrow ring and not the entire drilling surface. This allows the hole to be produced with

much less feed force and effort on the user's part – and in a much shorter time. One step is all it takes to make core-drilled holes in metal. This makes core drilling a very economical drilling technique.

Wide range of applications

Core drilling can be used for a wide range of tasks, from drilling in steel girders to overlapping holes, drilling in multi-layer materials and offset stop-drilling.

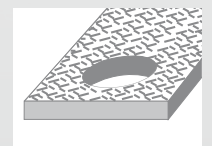
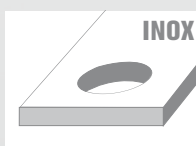
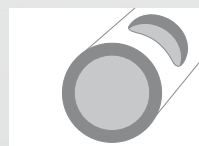
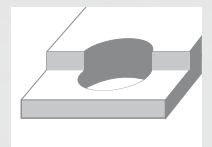
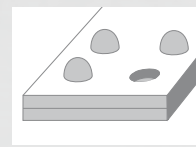
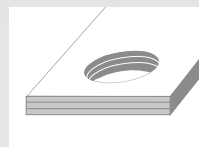
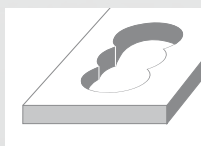
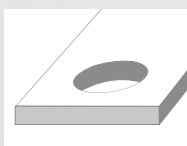



FEIN KBU 35 series:

The compact, powerful all-rounder with a large stroke range.

Small and powerful universal magnetic core drills with clockwise/anti-clockwise operation and very high functionality for flexible working.

FEIN KBH 25 series:

Efficient core drilling in metal. Rapid, flexible and hand-guided.

Flexible hand-guided metal core drilling system with work progress six times faster than twist drilling.

One core drill, many applications

The FEIN KBU 35 and the FEIN KBH 25 can do more than just core drilling: they can handle everything from twist drilling and thread-cutting to countersinking and reaming.



Core drilling



Twist drilling



Tapping

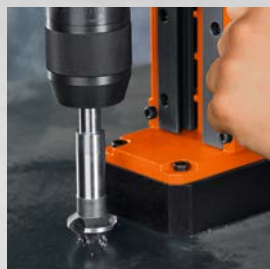

Countersinking

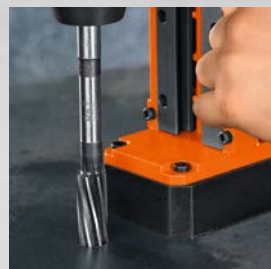

Reaming





Maximum performance. And portable too.

FEIN magnetic core drills in the KBU 35 series are the successors to the KBM 32 Q. Weighing in at just 10.6 kg, few other core drills are so lightweight. The low weight, compact design and narrow magnet, with a holding force of 10 000 N all make these tools ideal for mobile use on the construction site, even when used vertically or overhead. The FEIN KBU 35 tools are also extremely powerful and durable, offering a 260 mm stroke range for the use of very large drilling tools.

The benefits for you:

- ▶ Unique versatility, performance and cutting speed.
- ▶ Extremely wear-resistant, durable tool concept.
- ▶ Great flexibility and ergonomics thanks to lightweight design.
- ▶ Double drill motor guide for very large stroke.

Durable: Protective hose

Centrally positioned, swivel-mounted motor cable protection hose. Reduces the risk of snagging on the workpiece.

Powerful: FEIN high-power motor

FEIN 1100 W high-power motor with tacho electronics for high speed stability and economical operation.

Practical: 260 mm stroke range

Double motor guide ideal for use with very large drilling tools, are fully adjustable, without the need for tools via a clamping lever.

Extremely safe: Tilt sensor

Safe to use – tilt sensor immediately stops the machine if it slides or tilts.



Intuitive: the operating concept

The self-explanatory controls are in the operator's direct field of view – simple, practical and easily identifiable. Clockwise/anti-clockwise operation and electronic speed setting for universal use.

Useful: extra magnetic switch

Integrated in the drill jig for simple alignment of tool to workpiece, including vertical and overhead alignment.





FEIN KBU 35 QW

Small and powerful single-speed universal magnetic core drill with clockwise/anti-clockwise operation and very high functionality for flexible working on the construction site.

- ▶ The perfect assembly tool. Suitable for use in tight spaces due to extremely compact, slim tool construction.
- ▶ Ideal for all core drilling and occasional twist drilling with a drill chuck.



FEIN KBU 35-2 QW

Small and powerful 2-speed universal magnetic core drill with clockwise/anti-clockwise operation and high speed for efficient twist drilling on the construction site.

- ▶ Ideal for all core drilling and twist drilling thanks to its fast second gear with up to 1600 rpm.
- ▶ Extra narrow magnet, just 70 mm wide, for working in girder webs.



FEIN KBU 35 MQW



Small and powerful single-speed universal magnetic core drill with clockwise/anti-clockwise operation, MT2 tool mounting and very high functionality for flexible working on the construction site.

- ▶ Ideal for all core drilling and drilling tasks with MT2 insert tools.





Technical data

Model	KBU 35 QW	KBU 35-2 QW	KBU 35 MQW	
				
Core drilling	▲▲	▲▲	▲▲	
Twist drilling with drill chuck	▲	▲▲	▲	
Twist drilling with MT mount	–	–	▲▲	
Tapping	▲▲	▲▲	▲▲	
Countersinking	▲▲	▲▲	▲▲	
Reaming	▲▲	▲▲	▲▲	
Carbide core drill bit max. diameter	mm	35	35	
HSS core drill bit max. diameter	mm	35	35	
Max. bit drilling depth	mm	50	50 (75*)	
Twist drilling max. diameter	mm	16	18	
Tapping max.		M 14	M 14	
Countersinking max. diameter	mm	31	31	
Reaming max. diameter	mm	16	18	
Power consumption	W	1100	1100	
Power output	W	550	550	
Load speed	1st gear	rpm	130-520	130-520
	2nd gear	rpm	–	400-1600
Core drill fitting (tool-free)		¾ in Weldon	¾ in Weldon	
Tool mounting	MT	–	2	
Stroke / stroke range	mm	135/260	135/260	
Magnetic holding force	N	10 000	9 500	
Magnetic foot dimensions	mm	175 x 80 x 34	186 x 70 x 40	
Cable with plug	m	4	4	
Weight (according to EPTA)	kg	10.6	11.0	
Includes	1 magnetic core drill, 1 coolant tank, 1 safety strap, 1 swarf hook, 1 centring pin 105 mm, 1 contact guard, 1 drift key (KBU 35 MQW only), 1 case			
Order number	7 270 54 61 00 0	7 270 58 61 00 0	7 270 56 61 00 0	

Tough jobs need tough tools.

No matter what the material, application or diameter, FEIN's extensive range of core drill bits will have the right accessory for your job.





Find the right core drill bit now: www.fein-uk.co.uk/core-drilling

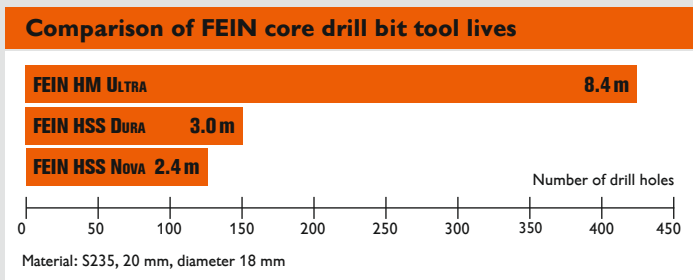





HM ULTRA: Durable and powerful in all metals.
HSS DURA: TiN coating, perfect for steel and stainless steel.
HSS NOVA: Resistant to shock and impact in steel construction and on the construction site.



The FEIN core drills range at a glance

	FEIN HM ULTRA	FEIN HSS DURA	FEIN HSS NOVA
			
	HM/TCT [WC-Co] 1450 HV	HSS + TiN 64HRC (800HV) TiN (3 µm): 1550 HV	HSS 64 HRC (800 HV)
			
	3/4 in Weldon	3/4 in Weldon	3/4 in Weldon
	25 mm	Ø 12-60 mm	Ø 12-60 mm
	35 mm	Ø 12-60 mm	Ø 12-60 mm
	50 mm	Ø 12-60 mm	Ø 12-60 mm
	75 mm	Ø 18-65 mm	Ø 19-60 mm

Material

	< 10% Si < 600N/mm ²	-	▲	▲▲
	> 10% Si < 600N/mm ²	-	▲	▲
	< 500 N/mm ²	▲▲▲	▲▲▲	▲▲▲
	< 750 N/mm ²	▲▲▲	▲▲▲	▲▲▲
	< 900 N/mm ²	▲▲▲	▲▲	▲
	< 1100 N/mm ²	▲▲	▲	-
	< 700 N/mm ²	▲▲	▲▲	▲
	> 700 N/mm ²	▲▲	▲	-
	< 300 N/mm ²	▲▲▲	-	▲
	< 500 N/mm ²	▲▲	-	-
	Hard-to-cut metals	▲▲	▲	-
	Rails	▲	-	-

Surfaces

Flat surfaces	▲▲▲	▲▲▲	▲▲▲
Structured, offset surfaces	▲	▲▲	▲▲
Pipe / round surfaces	▲▲	▲▲	▲▲

Special applications

Dry drilling	▲▲▲	▲▲▲	▲
Multi-layer drilling	▲	▲	▲
Overlapping drilling	▲▲	▲▲	▲▲

▲ suitable ▲▲ very suitable ▲▲▲ ideal



Carbide core drill bits



HM ULTRA core bit with 3/4 in Weldon fitting
Very long service life and outstanding cutting performance.

Ø mm	Cutting depth 35 mm	Cutting depth 50 mm	Cutting depth 75 mm
	Order number	Order number	Order number
12	6 31 27 714 01 0	6 31 27 276 01 0	
13	6 31 27 715 01 0	6 31 27 277 01 0	
14	6 31 27 716 01 0	6 31 27 278 01 0	
15	6 31 27 717 01 0	6 31 27 279 01 0	
16	6 31 27 718 01 0	6 31 27 280 01 0	
17	6 31 27 719 01 0	6 31 27 281 01 0	
18	6 31 27 720 01 0	6 31 27 282 01 0	6 31 27 785 01 0
19	6 31 27 721 01 0	6 31 27 283 01 0	6 31 27 786 01 0
20	6 31 27 722 01 0	6 31 27 284 01 0	6 31 27 787 01 0
21	6 31 27 723 01 0	6 31 27 285 01 0	6 31 27 788 01 0
22	6 31 27 724 01 0	6 31 27 286 01 0	6 31 27 789 01 0
23	6 31 27 725 01 0	6 31 27 287 01 0	6 31 27 790 01 0
24	6 31 27 726 01 0	6 31 27 288 01 0	6 31 27 791 01 0
25	6 31 27 727 01 0	6 31 27 289 01 0	6 31 27 792 01 0
26	6 31 27 728 01 0	6 31 27 290 01 0	6 31 27 793 01 0
27	6 31 27 729 01 0	6 31 27 291 01 0	6 31 27 794 01 0
28	6 31 27 730 01 0	6 31 27 292 01 0	6 31 27 795 01 0
29	6 31 27 731 01 0	6 31 27 293 01 0	6 31 27 796 01 0
30	6 31 27 732 01 0	6 31 27 294 01 0	6 31 27 797 01 0
31	6 31 27 733 01 0	6 31 27 295 01 0	
32	6 31 27 734 01 0	6 31 27 296 01 0	6 31 27 798 01 0
33	6 31 27 735 01 0	6 31 27 297 01 0	
34	6 31 27 736 01 0	6 31 27 298 01 0	
35	6 31 27 737 01 0	6 31 27 299 01 0	6 31 27 799 01 0

HSS core drill bits



HSS DURA core bit with 3/4 in Weldon fitting
TiN coating for outstanding durability and glide properties.



HSS Nova core bit with 3/4 in Weldon fitting
Long service life.

Ø mm	Cutting depth 25 mm	Cutting depth 50 mm
	Order number	Order number
12	6 31 34 120 07 5	6 31 34 120 07 6
13	6 31 34 130 07 5	6 31 34 130 07 6
14	6 31 34 140 07 5	6 31 34 140 07 6
15	6 31 34 150 07 5	6 31 34 150 07 6
16	6 31 34 160 07 5	6 31 34 160 07 6
17	6 31 34 170 07 5	6 31 34 170 07 6
18	6 31 34 180 07 5	6 31 34 180 07 6
19	6 31 34 190 07 5	6 31 34 190 07 6
20	6 31 34 200 07 5	6 31 34 200 07 6
21	6 31 34 210 07 5	6 31 34 210 07 6
22	6 31 34 220 07 5	6 31 34 220 07 6
23	6 31 34 230 07 5	6 31 34 230 07 6
24	6 31 34 240 07 5	6 31 34 240 07 6
25	6 31 34 250 07 5	6 31 34 250 07 6
26	6 31 34 260 07 5	6 31 34 260 07 6
27	6 31 34 270 07 5	6 31 34 270 07 6
28	6 31 34 280 07 5	6 31 34 280 07 6
29	6 31 34 290 07 5	6 31 34 290 07 6
30	6 31 34 300 07 5	6 31 34 300 07 6
31	6 31 34 310 07 5	6 31 34 310 07 6
32	6 31 34 320 07 5	6 31 34 320 07 6
33	6 31 34 330 07 5	6 31 34 330 07 6
34	6 31 34 340 07 5	6 31 34 340 07 6
35	6 31 34 350 07 5	6 31 34 350 07 6

Ø mm	Cutting depth 25 mm	Cutting depth 50 mm	Cutting depth 75 mm
	Order number	Order number	Order number
12	6 31 34 120 05 1	6 31 34 120 05 2	
13	6 31 34 130 05 1	6 31 34 130 05 2	
14	6 31 34 140 05 1	6 31 34 140 05 2	
15	6 31 34 150 05 1	6 31 34 150 05 2	
16	6 31 34 160 05 1	6 31 34 160 05 2	
17	6 31 34 170 05 1	6 31 34 170 05 2	
18	6 31 34 180 05 1	6 31 34 180 05 2	
19	6 31 34 190 05 1	6 31 34 190 05 2	6 31 34 190 05 3
20	6 31 34 200 05 1	6 31 34 200 05 2	6 31 34 200 05 3
21	6 31 34 210 05 1	6 31 34 210 05 2	6 31 34 210 05 3
22	6 31 34 220 05 1	6 31 34 220 05 2	6 31 34 220 05 3
23	6 31 34 230 05 1	6 31 34 230 05 2	6 31 34 230 05 3
24	6 31 34 240 05 1	6 31 34 240 05 2	6 31 34 240 05 3
25	6 31 34 250 05 1	6 31 34 250 05 2	6 31 34 250 05 3
26	6 31 34 260 05 1	6 31 34 260 05 2	6 31 34 260 05 3
27	6 31 34 270 05 1	6 31 34 270 05 2	6 31 34 270 05 3
28	6 31 34 280 05 1	6 31 34 280 05 2	6 31 34 280 05 3
29	6 31 34 290 05 1	6 31 34 290 05 2	6 31 34 290 05 3
30	6 31 34 300 05 1	6 31 34 300 05 2	6 31 34 300 05 3
31	6 31 34 310 05 1	6 31 34 310 05 2	
32	6 31 34 320 05 1	6 31 34 320 05 2	6 31 34 320 05 3
33	6 31 34 330 05 1	6 31 34 330 05 2	
34	6 31 34 340 05 1	6 31 34 340 05 2	
35	6 31 34 350 05 1	6 31 34 350 05 2	6 31 34 350 05 3

Centring pins



Length mm	Order number
80	3 02 17 359 00 0
105	3 02 17 332 00 9
125	3 02 17 333 00 3

Drill chuck adapters/mounting shafts



Adapter with 3/4 in Weldon fitting
B 16 output.

Order number	6 39 01 061 00 0
--------------	------------------



3/4 in Weldon mounting shaft
With internal cooling lubricant supply.

Taper	Drill Ø mm	Cutting depth mm	Order number
MT 2	12-35	75	6 39 01 064 02 0

Tapping



Tapping quick-change chuck with 3/4 in Weldon fitting
Can only be used for magnetic core drills with reverse running function. Size 2, with 3/4 in Weldon fitting, for thread drills, in conjunction with tapping inserts with or without M6-M20 safety clutch.

Order number	9 26 02 089 01 0
--------------	------------------



Size 2 tapping inserts

For thread drills in accordance with DIN 371.

Thread	Ø mm	Square mm	Order number
M6	6	4.9	6 32 06 095 01 1
M8	8	6.2	6 32 06 138 01 0
M10	10	8	6 32 06 139 01 0

Size 2 tapping inserts

For thread drills in accordance with DIN 374/376.

Thread	Ø mm	Square mm	Order number
M6	4.5	3.4	6 32 06 117 01 5
M8	6	4.9	6 32 06 095 01 1
M10	7	5.5	6 32 06 096 01 4
M12	9	7	6 32 06 097 01 8
M14	11	9	6 32 06 098 01 6



Size 2 tapping inserts

With safety clutch for blind holes.
For thread drills in accordance with DIN 371.

Thread	Ø mm	Square mm	Order number
M6	6	4.9	6 32 06 118 01 3
M8	8	6.2	6 32 06 140 01 0
M10	10	8	6 32 06 141 01 0

Size 2 tapping inserts

With safety clutch for blind holes.
For thread drills in accordance with DIN 374 / 376.

Thread	Ø mm	Square mm	Order number
M8	6	4.9	6 32 06 102 01 3
M10	7	5.5	6 32 06 103 01 7
M12	9	7	6 32 06 104 01 5
M14	11	9	6 32 06 105 01 9



Hand-guided core drilling in metal. Incredibly simple.

Power and portability: the FEIN KBH 25 is the only hand-guided metal core drilling system. The perfect interaction of powerful handheld drill, optimum speed, patented drilling technology and carbide core drill bits with special cutting geometry guarantees that you can save huge amounts of time and money. The FEIN KBH 25 is up to 6 times faster than twist drilling and up to 3 times faster than the carbide hole saws now established on the market.

The benefits for you:

- ▶ Powerful for excellent work progress.
- ▶ Unique cost-effectiveness thanks to innovative drilling technology.
- ▶ Maximum flexibility and versatility.
- ▶ Optimum handling thanks to low feed force.



FEIN KBH 25 S

Hand-guided single-speed metal core drilling system for rapid and flexible use of core drills.

- ▶ Ideal for core drilling in metal and hole sawing in sheet metal

KBH 25-2 U

Hand-guided 2-speed metal core drilling system for universal use of core drills and twist drills.

- ▶ Ideal for universal use thanks to manually controlled second gear for core drilling in metal, hole sawing in sheet metal, twist drilling, tapping and countersinking.

Up to 6 times faster than twist drilling

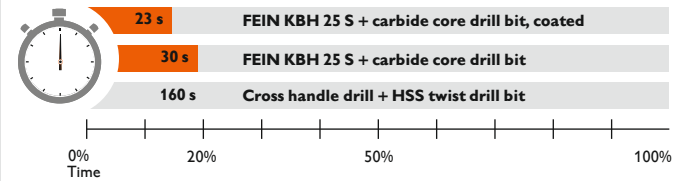

Faster working thanks to innovative drilling technology

5 mm deep centre drilling at 1600 rpm followed by decoupling of centring drill and automatic change of speed to 520 rpm to set optimum cutting speed for carbide core drill. With its specially developed cutting geometry, the carbide core drill bit achieves the desired hole diameter with little effort on the user's part.

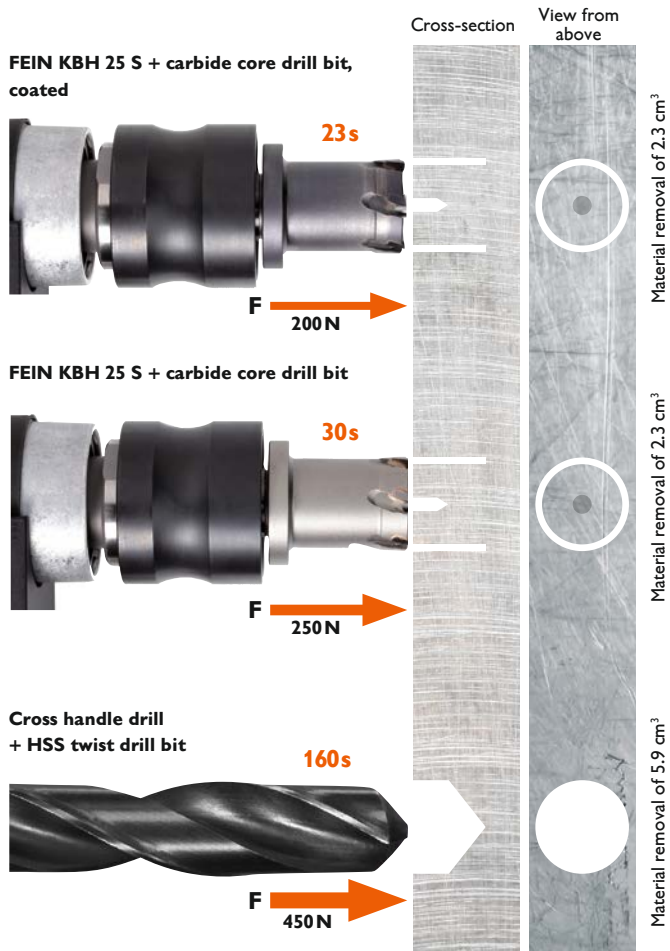



NEW

Flexible: Clockwise/anti-clockwise operation and speed setting

For infinitely variable adjustment of speed to particular processes. Clockwise/anti-clockwise operation for universal use.

Tool-free: FEIN QuickIN PLUS

Change in a matter of seconds. One click and the tool is perfectly secured.



Fast: Innovative drilling technology

Rapid work progress and short drilling times with considerably less effort thanks to innovative drilling technology and special core drill bit cutting geometry.

Powerful: FEIN high-power motor

FEIN 1200 W high-power motor with tacho electronics for high speed stability and economical operation.



Extremely safe: Slipping clutch

Protects the user by isolating the output side from the drive side in the event of overload.





Technical data

Model		KBH 25 S	KBH 25-2 U
			
Core drilling in metal		▲▲	▲▲
Sawing holes in sheet metal		▲▲	▲▲
Twist drilling		-	▲▲
Tapping		-	▲▲
Countersinking		-	▲▲
Hole Ø in steel/stainless steel, carbide core drill	mm	25	25
Hole Ø in light metal, carbide core drill	mm	30	30
Carbide core drill, max. bit drilling depth	mm	20	20
Hole Ø in steel/stainless steel, carbide hole saw	mm	80	80
Carbide hole saw, max. bit drilling depth	mm	4	4
Hole Ø in steel/stainless steel, twist drill	mm	-	16
Tapping max.		-	M 12
Countersinking max. Ø	mm	-	31
Power consumption	W	1200	1200
Power output	W	680	680
Load speed	Centre drilling	rpm	0-1 600*
	1st gear (core drilling)	rpm	0-520*
	2nd gear (twist drilling)	rpm	-
Torque at max. output power / stall torque	Nm	50**	50**
Collar Ø		43	43
Core drill fitting (tool-free)		FEIN QuickIN PLUS	FEIN QuickIN PLUS
Cable with plug	m	4	4
Width across corners	mm	27	27
Weight according to EPTA	kg	3.3	3.3
** Torque slipping clutch		■	■
Clockwise/anti-clockwise		■	■
Acceleration electronics		■	■
Speed preselection		■	■
Tacho control		■	■
Includes		1 metal core drill, 1 centring bit, 1 quick-clamping chuck (KBH 25-2 U only), 1 additional handle, 1 cutting spray, 1 plastic tool case	
Order number		7 271 04 61 00 0	7 271 03 61 00 0

Carbide core drill bits

Carbide core drill bit with QuickIN PLUS holder

Cutting depth 20 mm.



Drill Ø mm	Order number
14	6 31 30 014 01 0
15	6 31 30 015 01 0
16	6 31 30 016 01 0
17	6 31 30 017 01 0
18	6 31 30 018 01 0
19	6 31 30 019 01 0
20	6 31 30 020 01 0
21	6 31 30 021 01 0
22	6 31 30 022 01 0
23	6 31 30 023 01 0
24	6 31 30 024 01 0
25	6 31 30 025 01 0
26	6 31 30 026 01 0
27	6 31 30 027 01 0
28	6 31 30 028 01 0
29	6 31 30 029 01 0
30	6 31 30 030 01 0

Carbide core drill bits with TiAlN coating

Carbide core drill bits with TiAlN coating and QuickIN PLUS holder

Cutting depth 20 mm.



Drill Ø mm	Order number
14	6 31 30 114 01 0
15	6 31 30 115 01 0
16	6 31 30 116 01 0
17	6 31 30 117 01 0
18	6 31 30 118 01 0
19	6 31 30 119 01 0
20	6 31 30 120 01 0
21	6 31 30 121 01 0
22	6 31 30 122 01 0
23	6 31 30 123 01 0
24	6 31 30 124 01 0
25	6 31 30 125 01 0
26	6 31 30 126 01 0
27	6 31 30 127 01 0
28	6 31 30 128 01 0
29	6 31 30 129 01 0
30	6 31 30 130 01 0

Carbide hole saws

Carbide hole saw with QuickIN PLUS holder

Cutting depth 4 mm.



Drill Ø mm	Order number
14	6 31 31 014 01 0
15	6 31 31 015 01 0

16	6 31 31 016 01 0
17	6 31 31 017 01 0
18	6 31 31 018 01 0
19	6 31 31 019 01 0
20	6 31 31 020 01 0
21	6 31 31 021 01 0
22	6 31 31 022 01 0
23	6 31 31 023 01 0
24	6 31 31 024 01 0
25	6 31 31 025 01 0
26	6 31 31 026 01 0
27	6 31 31 027 01 0
28	6 31 31 028 01 0
29	6 31 31 029 01 0
30	6 31 31 030 01 0
31	6 31 31 031 01 0
32	6 31 31 032 01 0
33	6 31 31 033 01 0
34	6 31 31 034 01 0
35	6 31 31 035 01 0
36	6 31 31 036 01 0
37	6 31 31 037 01 0
38	6 31 31 038 01 0
39	6 31 31 039 01 0
40	6 31 31 040 01 0
41	6 31 31 041 01 0
42	6 31 31 042 01 0
43	6 31 31 043 01 0
44	6 31 31 044 01 0
45	6 31 31 045 01 0
46	6 31 31 046 01 0
47	6 31 31 047 01 0
48	6 31 31 048 01 0
49	6 31 31 049 01 0
50	6 31 31 050 01 0
51	6 31 31 051 01 0
52	6 31 31 052 01 0
53	6 31 31 053 01 0
54	6 31 31 054 01 0
55	6 31 31 055 01 0
56	6 31 31 056 01 0
57	6 31 31 057 01 0
58	6 31 31 058 01 0
59	6 31 31 059 01 0
60	6 31 31 060 01 0
65	6 31 31 065 01 0
68	6 31 31 068 01 0
70	6 31 31 070 01 0
75	6 31 31 075 01 0
80	6 31 31 080 01 0

Carbide hole saws for pipes

Carbide hole saw for pipes with QuickIN PLUS holder

Cutting depth 4 mm.



Drill Ø mm	Order number
21	6 31 31 421 01 0
22	6 31 31 422 01 0
23	6 31 31 423 01 0
24	6 31 31 424 01 0
25	6 31 31 425 01 0
26	6 31 31 426 01 0
27	6 31 31 427 01 0
28	6 31 31 428 01 0
29	6 31 31 429 01 0
30	6 31 31 430 01 0
31	6 31 31 431 01 0
32	6 31 31 432 01 0
33	6 31 31 433 01 0

34	6 31 31 434 01 0
35	6 31 31 435 01 0
36	6 31 31 436 01 0
37	6 31 31 437 01 0
38	6 31 31 438 01 0
39	6 31 31 439 01 0
40	6 31 31 440 01 0
41	6 31 31 441 01 0
42	6 31 31 442 01 0
43	6 31 31 443 01 0
44	6 31 31 444 01 0
45	6 31 31 445 01 0
46	6 31 31 446 01 0
47	6 31 31 447 01 0
48	6 31 31 448 01 0
49	6 31 31 449 01 0
50	6 31 31 450 01 0
51	6 31 31 451 01 0
52	6 31 31 452 01 0
53	6 31 31 453 01 0
54	6 31 31 454 01 0
55	6 31 31 455 01 0
56	6 31 31 456 01 0
57	6 31 31 457 01 0
58	6 31 31 458 01 0
59	6 31 31 459 01 0
60	6 31 31 460 01 0
65	6 31 31 465 01 0
68	6 31 31 468 01 0

Centring drill bit



No. in pack	Order number
1	6 31 14 038 01 0
5	6 31 14 038 02 0

Tapping

Collet chuck

With collets 6/7/9 mm.

Order number	6 32 06 067 02 0
--------------	------------------

Collets

For collet chuck.

Thread	Ø mm	■ mm	Order number
M2-M2.6	2.8	2.1	6 32 06 077 00 1
M3	3.5	2.7	6 32 06 064 00 1
M 4 / M 6	4.5	3.4	6 32 06 065 00 5
M 5 / M 8	6	4.9	6 32 06 066 00 8
M 10	7	5.5	6 32 06 070 00 6
M 8	8	6.2	6 32 06 078 00 9
M 12	9	7	6 32 06 075 00 4
M10	10	8	6 32 06 079 00 3

Jaw chuck

Directly holds thread drill
Clamping range 2.8 mm - 9.0 mm, with wrench.

Order number	6 32 06 018 01 0
--------------	------------------

Other accessories

Swarf cup

Prevents contact with hot swarf with sharp edges.

Order number	3 21 74 013 01 0
--------------	------------------

Cutting spray

300 ml pump spray, for long tool life, optimum cutting performance and enhanced swarf flow.

Order number	3 21 32 031 00 0
--------------	------------------

Extension

For use on confined, deep or layered surfaces. QuickIN PLUS holder, length 100 mm, including adapter for centring drill bit.

Order number	6 31 06 017 01 0
--------------	------------------

QuickIN PLUS adapter on B16

Order number	6 39 01 047 00 0
--------------	------------------

QuickIN PLUS adapter for 1/2 in 20 UNF

Order number	6 39 01 054 00 0
--------------	------------------

Key-type drill chuck

Drill chuck holder B 16
Clamping width 1.5-13 mm

Order number	6 32 02 030 01 5
--------------	------------------

Quick-clamping drill chuck

Drill chuck holder B 16
R-shaped tip with chucking force safety device.
Clamping width 1-13 mm

Order number	6 32 04 032 00 6
--------------	------------------

Quick-clamping drill chuck

SUPRA SKE single-sheath metal quick-clamping drill chuck with chucking force safety device, drill chuck holder 1/2" - 20 UNF.
Clamping width 3-16 mm

Order number	6 32 05 038 01 0
--------------	------------------

Quick-clamping drill chuck

SUPRA SKE single-sheath metal quick-clamping drill chuck with chucking force safety device, QuickIN Plus holder.
Clamping width 3-16 mm







Order number	6 39 01 054 01 0
--------------	------------------

Core drilling in metal, in any situation.

The FEIN core drills range includes the right tool for every job. From hand-guided to stationary core drilling, FEIN covers every metal drilling application with diameters of 0.5 mm to 80 mm and cutting depths of up to 75 mm. From the flexible hand-guided metal core

drilling system with fast cutting speed to the magnetic core drills in the Economical, Compact, Universal and Automatic performance classes. We've got the right solution for every application, thanks to our extensive range of accessories.

FEIN core drills range

Hand-guided core drilling system	Magnetic core drills	
<p>Mobile</p> <p>Flexibility for core drilling in any material and surface</p>	<p>Economical</p> <p>Basic functionality for core drilling</p>	<p>Compact</p> <p>Optimised size for use in confined or hard-to-reach places</p>
<p>NEW</p>  <p>FEIN KBH 25 S</p> <p>Hand-guided single-speed metal core drilling system up to 25 mm diameter</p>	 <p>FEIN KBB 30</p> <p>Small and lightweight single-speed economical magnetic core drill up to 30 mm diameter</p>	 <p>FEIN KBB 40</p> <p>Extremely small single-speed compact magnetic core drill up to 40 mm diameter with fixed drill motor</p>
<p>NEW</p>  <p>FEIN KBH 25-2 U</p> <p>Hand-guided 2-speed metal core drilling system up to 25 mm diameter</p>	 <p>FEIN KBB 38</p> <p>Compact and precise single-speed economical magnetic core drill up to 38 mm diameter</p>	
	 <p>FEIN KBB 60</p> <p>Precise 2-speed economical magnetic core drill up to 60 mm diameter and 75 mm cutting depth</p>	 <p>The FEIN core drills range at www.fein-uk.co.uk/core-drilling</p>



The benefits for you:

- ▶ Different performance classes to cover every application.
- ▶ Maximum versatility and flexibility.
- ▶ Outstanding service life and reliability.
- ▶ First-class materials and excellent workmanship.

Magnetic core drills

Universal

Versatility
thanks to maximum functionality

Automatic

Maximum efficiency
thanks to fully automatic
drill feed

NEW



FEIN KBU 35 QW

Small and powerful single-speed universal magnetic core drill up to 35 mm diameter



FEIN KBM 50 Q

Lightweight and powerful 2-speed universal magnetic core drill up to 50 mm diameter



FEIN KBM 80 U

High-performance and powerful 3-speed universal magnetic core drill up to 80 mm diameter with MT3 tool mounting



FEIN KBM 50 auto

Lightweight and powerful 2-speed automatic magnetic core drill up to 50 mm diameter with MT3 tool mounting

NEW



FEIN KBU 35-2 QW

Small and powerful 2-speed universal magnetic core drill up to 35 mm diameter



FEIN KBM 50 U

Lightweight and powerful 2-speed universal magnetic core drill up to 50 mm diameter with MT3 tool mounting



FEIN KBM 80 auto

High-performance and powerful 3-speed automatic magnetic core drill up to 80 mm diameter with MT3 tool mounting

NEW



FEIN KBU 35 MQW

Small and powerful single-speed universal magnetic core drill up to 35 mm diameter with MT2 tool mounting



FEIN KBM 65 U

High-performance and powerful 2-speed universal magnetic core drill up to 65 mm diameter with MT3 tool mounting

**FEIN. Unverwüstliche
Elektrowerkzeuge.**



FEIN. Durable power tools.

FEIN is the specialist for professional and extremely reliable power tools and special application solutions in the metal, interior and automotive sectors. As the inventor of the electric hand drill, FEIN has been developing innovative and unbeatably efficient solutions for everyday use which can also stand up to the toughest continuous use in industry and trade for over 140 years.



**Quick registration – extended warranty period:
The 3-year FEIN PLUS warranty.**

We offer the 3-year FEIN PLUS warranty for all your FEIN power tools. All you need to do is register your new FEIN product at www.fein.com/warranty within 6 weeks of purchase.

Find out more and discover the benefits for yourself.

Want to find out more about FEIN core drills or try them out for yourself at your own premises? Visit us online at www.fein-uk.co.uk/core-drilling and book a date for an exclusive demo.

Your specialist dealer will be happy to help:

DE: C. & E. Fein GmbH, Tel. +49 (0)7173 183-0, www.fein.com

UK: FEIN Industrial Power Tools UK Ltd., Phone 01327 308730, www.fein-uk.co.uk

