

**FEIN. Unverwüstliche  
Elektrowerkzeuge.**



## **Price list machines and accessories 2018**



# Welcome to FEIN – your specialist in metal and interiors.

FEIN is synonymous with extremely reliable application solutions for manual trades and industry when working with metal, timber and composite materials.



Application solutions for drilling, core drilling, sanding, screwdriving and surface processing – FEIN's wide yet specialised range of power tools and accessories makes it a specialist for the metal industry. 50 years ago, FEIN invented the oscillating multi-tool. Since then, tradesmen have put their trust in THE ORIGINAL. What's more, FEIN provides specific processing solutions for timber and composite materials too.

## We shape the future. 150 years of FEIN. An eternal promise.



Founded in 1867 by Wilhelm Emil Fein, FEIN is now one of the world's leading power tool manufacturers. Right from the start, the end user has always been at the heart of everything we do and will continue to be so.



As a specialist in solutions, we develop tools, accessories and consumables, which simplify work for users in the areas of metal, timber and composite materials. All developed and produced by FEIN.

As the inventor of the drill, development is part and parcel of our philosophy. For 150 years, we have been developing and building power tools for the future to perfect and simplify the work of our customers on a daily basis.



We shape the future



**2017**  
4-speed cordless drill/  
driver with QuickIN MAX



**2016**  
Oscillating multi-tool  
with Starlock tool  
mounting



**1987**  
First safety angle  
grinder



**1967**  
The first oscillating  
multi-tool



**1914**  
The FEIN hammer

**1895**  
The world's first power  
tool – the drill.



**1867**  
The founder



W. E. Fein



## Drilling

Drills	4	Magnetic drill jigs	12
Angle drills	10	Tappers	15

## Fastening

Drill/Driver	20	FEIN AccuTEC	30	Dry wall screw guns	39
Cordless impact wrench/driver	26	Metal screw gun	37		

## Grinding

Cordless angle grinder	44	Angle Grinders	53	HF-angle grinder	62
Compact angle grinders	46	Die Grinders	56	High Frequency Straight Grinders	66

## Sheet metal working

Slitting shears	72	Sheet metal shears	75	Nibblers	78
-----------------	----	--------------------	----	----------	----

## Sawing and cutting

Jigsaws	86	Pipe Saws	89	Construction cutter	93
---------	----	-----------	----	---------------------	----

## Metal core drilling

Mobile	96	Compact	102	Automatic	121
Economical	100	Universal	108		

## Wet / dry dust extractor

Wet / dry dust extractor	126		124
--------------------------	-----	--	-----

## Surface processing

Sanders	132	Polishers	143
---------	-----	-----------	-----

## Oscillating multi-tool

FEIN MULTIMASTER / MULTITALENT	150	FEIN SUPERCUT CONSTRUCTION	154	FEIN SUPERCUT AUTOMOTIVE	176
--------------------------------	-----	----------------------------	-----	--------------------------	-----

## Belt grinders

GRIT GHB hand-guided belt grinder	184	GRIT GX add-on modules for manual trades	190	GRIT GKS compact belt grinder	199
GRIT GHB add-on modules	186	GRIT GI basic belt grinder for industry	192		
GRIT GX basic belt grinder for manual trades	188	GRIT GI add-on modules for industry	194		

## Accessories

Balancers	210		208
-----------	-----	--	-----

## Accessories, numerical part

Machines in numerical order	215	Accessories in numerical order	220	Vibration and noise emission values	257
-----------------------------	-----	--------------------------------	-----	-------------------------------------	-----



# We are the experts when it comes to drills. After all, we invented them.

In 1895 FEIN revolutionised manual work by inventing the first electric hand drill. Even today, FEIN drills bear the stamp of the same spirit of innovation: The best of 150 years of experience and always in enduring premium quality, whether drills, angle drills or thread drills. There are FEIN drills for almost any situation, with different sizes and shapes, drilling diameters of up to 38 mm and speeds adapted precisely to the material. These tools are perfectly tailored to the work you do, the standards you need to meet, and your way of working. Ergonomically shaped, lightweight, easy to operate and extremely durable, they are ideal for professional

users. The optimised range of accessories and special system components underline the expertise and experience that goes into a FEIN drill.



---

<b>Drills</b>	<b>Page</b>	<b>4</b>
Perfectly suited to the job. Precise, powerful, easy to use.		

---



---

<b>Angle drills</b>	<b>Page</b>	<b>10</b>
Makes easy work of drilling round corners. Compact, versatile and powerful, for difficult or narrow locations.		

---



---

<b>Magnetic drill jigs</b>	<b>Page</b>	<b>12</b>
Horizontal, vertical or overhead working: easy to use and flexible, on site or in the workshop.		

---





---

<b>Tappers</b>	<b>Page</b>	<b>15</b>
Efficient, precise and reliable. The alternative to working by hand.		

---

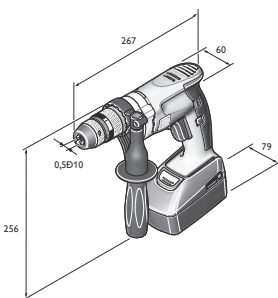

	ABOP 6 Select	ABOP 10 Select	ABOP 13-2 Select	BOP 6	BOP 10	BOP 10-2	
	Fast-running single-speed drill (battery-powered) with excellent speed stability, up to 6 mm in steel in metal construction.	Compact single-speed drill with speed stability (battery-powered), up to 10 mm in steel for on-site installation work.	Universal two-speed drill (battery-powered), up to 13 mm with ideal speed range for steel and stainless steel.	Fast-running single-speed drill with good speed stability, up to 6 mm in steel in metal construction.	Compact single-speed drill with speed stability, up to 10 mm in steel for on-site installation work.	Universal two-speed drill, up to 10 mm with ideal speed range for steel and stainless steel.	
<b>EAN 4014586...</b>	... 881744	... 881751	... 881768				
<b>Page</b>	6	6	6	6	6	7	
<b>Technical features</b>	Input				500 W	500 W	500 W
	Output				270 W	270 W	270 W
	Battery voltage	18 V	18 V	18 V			
	Battery compatibility	Li-ion / HighPower Li-ion	Li-ion / HighPower Li-ion	Li-ion / HighPower Li-ion			
	Battery interface	18 V	18 V	18 V			
	Speed, no load	0 - 3 350 1/min	0 - 1 250 1/min	0 - 580 / 0 - 1 760 1/min	0 - 4 000 1/min	0 - 1 500 1/min	0 - 700 / 0 - 2 250 1/min
	Speed, full load	0 - 2 900 1/min	0 - 1 100 1/min	0 - 500 / 0 - 1 500 1/min	0 - 2 700 1/min	0 - 900 1/min	0 - 460 / 0 - 1 350 1/min
	Capacity in steel Ø	6 mm	10 mm	13 mm	6 mm	10 mm	10 mm
	capacity in Ø stainless steel	6 mm	10 mm	13 mm	6 mm	10 mm	10 mm
	Capacity in alu Ø	10 mm	15 mm	16 mm	10 mm	15 mm	16 mm
	Capacity in wood Ø	20 mm	30 mm	37 mm	20 mm	30 mm	35 mm
	Tapping		M 6	M 10		M 6	M 10
	Weight according to EPTA				1,70 kg	1,80 kg	2,00 kg
Weight without storage battery	1,40 kg	1,50 kg	1,70 kg				



ABOP 6

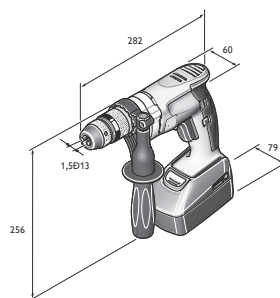

ABOP 10

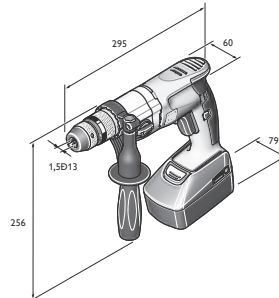

ABOP 13-2

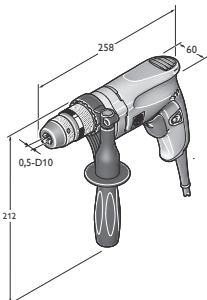

BOP 6

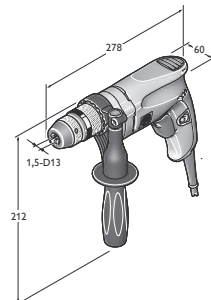

BOP 10

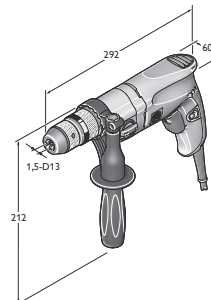

BOP 10-2

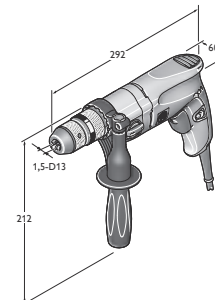

BOP 13-2

	<b>BOP 13-2</b>	<b>BOS 16</b>	<b>BOS 16-2</b>	<b>DSke 672</b>	<b>DDSk 672</b>	<b>DDSk 672-1</b>	<b>ASq 672-1</b>
	Universal two-speed drill, up to 13 mm with ideal speed range for steel and stainless steel.	Powerful drill with speed setting for flexible use in metal construction.	Powerful two-speed drill with speed setting for flexible use in metal construction.	Large two-speed drill with high torque.	Extremely robust four-speed rotary drill for heavy-duty drilling and reaming.	Universal four-speed rotary drill with reversible rotation and high drilling / tapping capacity.	Slow-speed drill and drive unit with very high torque.
		... 874463	... 876443	... 802855	... 802749	... 804453	... 804569
	7	7	7	7	8	8	8
	550 W	1 200 W	1 200 W	1 050 W	1 050 W	900 W	900 W
	300 W	680 W	680 W	650 W	650 W	500 W	500 W
	0 - 680 / 0 - 2 200 1/min	0 - 520 1/min	0 - 520 / 0 - 1 600 1/min	120 - 270 / 240 - 540 1/min	175 / 280 / 480 / 760 1/min	170 / 250 / 450 / 700 1/min	100 1/min
	0 - 440 / 0 - 1 300 1/min	0 - 520 1/min	0 - 520 / 0 - 1 600 1/min	110 - 185 / 220 - 370 1/min	120 / 190 / 330 / 520 1/min	100 / 150 / 260 / 420 1/min	60 1/min
	13 mm	16 mm	16 mm	26 mm	32 mm	32 mm	38 mm
	13 mm	16 mm	16 mm	26 mm	32 mm	32 mm	38 mm
	16 mm	20 mm	20 mm	32 mm	40 mm	40 mm	
	37 mm	50 mm	50 mm	50 mm	60 mm	60 mm	
	M 10	M 12	M 12			M 20	M 30/R 1"
	2,00 kg	3,50 kg	3,70 kg	8,80 kg	9,40 kg	9,60 kg	10,60 kg

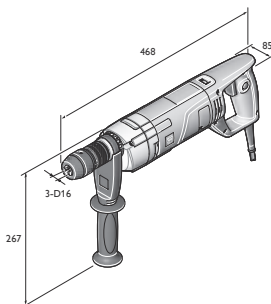

BOS 16

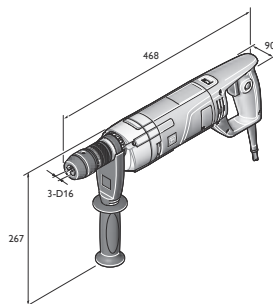

BOS 16-2

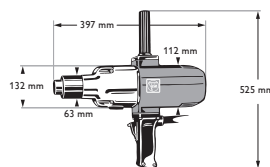

DDSk 672-1

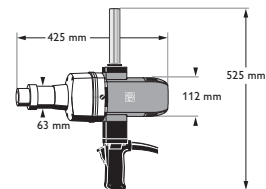

ASq 672-1

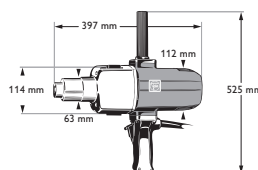

DSke 672

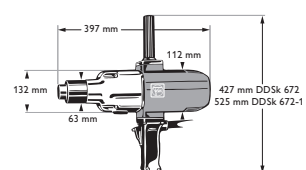

DDSk 672

**FEIN SELECT<sup>+</sup>**



Type	Part number	EAN	PC	£ List Price excl. VAT
<b>ABOP 6 Select</b>	<b>7 105 01 62 00 0</b>	<b>4014586881744</b>	<b>01</b>	<b>304.00</b>

**Price includes:**  
1 SUPRA SKE single sheath metal quick clamping drill chuck, 1 additional handle, 1 plastic carrying case  
For accessories, see page 8

**FEIN SELECT<sup>+</sup>**



Type	Part number	EAN	PC	£ List Price excl. VAT
<b>ABOP 10 Select</b>	<b>7 105 02 62 00 0</b>	<b>4014586881751</b>	<b>01</b>	<b>304.00</b>

**Price includes:**  
1 SUPRA SKE single sheath metal quick clamping drill chuck, 1 additional handle, 1 plastic carrying case  
For accessories, see page 8

**FEIN SELECT<sup>+</sup>**



Type	Part number	EAN	PC	£ List Price excl. VAT
<b>ABOP 13-2 Select</b>	<b>7 105 03 62 00 0</b>	<b>4014586881768</b>	<b>01</b>	<b>363.00</b>

**Price includes:**  
1 SUPRA SKE single sheath metal quick clamping drill chuck, 1 additional handle, 1 plastic carrying case  
For accessories, see page 8



Type	Part number	PC	£ List Price excl. VAT
<b>BOP 6</b>	<b>7 205 52 60</b>	<b>01</b>	<b>358.00</b>

**Price includes:**  
1 SUPRA SKE single sheath metal quick clamping drill chuck, 1 additional handle  
For accessories, see page 8



Type	Part number	PC	£ List Price excl. VAT
<b>BOP 6</b>	<b>7 205 52 61</b>	<b>01</b>	<b>391.00</b>

**Price includes:**  
1 SUPRA SKE single sheath metal quick clamping drill chuck, 1 additional handle, 1 plastic carrying case  
For accessories, see page 8



Type	Part number	PC	£ List Price excl. VAT
<b>BOP 10</b>	<b>7 205 53 60</b>	<b>01</b>	<b>358.00</b>

**Price includes:**  
1 SUPRA SKE single sheath metal quick clamping drill chuck, 1 additional handle  
For accessories, see page 8



Type	Part number	PC	£ List Price excl. VAT
<b>BOP 10</b>	<b>7 205 53 61</b>	<b>01</b>	<b>391.00</b>

**Price includes:**  
1 SUPRA SKE single sheath metal quick clamping drill chuck, 1 additional handle, 1 plastic carrying case  
For accessories, see page 8





Type	Part number	PC	£ List Price excl. VAT
<b>BOP 10-2</b>	<b>7 205 54 60</b>	<b>01</b>	<b>436.00</b>

**Price includes:**

1 SUPRA SKE single sheath metal quick clamping drill chuck, 1 additional handle

For accessories, see page 8



Type	Part number	PC	£ List Price excl. VAT
<b>BOP 10-2</b>	<b>7 205 54 61</b>	<b>01</b>	<b>454.00</b>

**Price includes:**

1 SUPRA SKE single sheath metal quick clamping drill chuck, 1 additional handle, 1 plastic carrying case

For accessories, see page 8



Type	Part number	PC	£ List Price excl. VAT
<b>BOP 13-2</b>	<b>7 205 55 60</b>	<b>01</b>	<b>458.00</b>

**Price includes:**

1 SUPRA SKE single sheath metal quick clamping drill chuck, 1 additional handle

For accessories, see page 8



Type	Part number	PC	£ List Price excl. VAT
<b>BOP 13-2</b>	<b>7 205 55 61</b>	<b>01</b>	<b>489.00</b>

**Price includes:**

1 SUPRA SKE single sheath metal quick clamping drill chuck, 1 additional handle, 1 plastic carrying case

For accessories, see page 8



Type	Part number	EAN	PC	£ List Price excl. VAT
<b>BOS 16*</b>	<b>7 205 47 60 00 0</b>	<b>4014586874463</b>	<b>01</b>	<b>575.00</b>

**Price includes:**

1 SUPRA SKE single sheath metal quick clamping drill chuck, 1 additional handle

For accessories, see page 8

\* 230 V only



Type	Part number	EAN	PC	£ List Price excl. VAT
<b>BOS 16-2*</b>	<b>7 205 49 60 00 0</b>	<b>4014586876443</b>	<b>01</b>	<b>665.00</b>

**Price includes:**

1 SUPRA SKE single sheath metal quick clamping drill chuck, 1 additional handle

For accessories, see page 8

\* 230 V only



Type	Part number	EAN	PC	£ List Price excl. VAT
<b>DSke 672*</b>	<b>7 202 09 00 22 7</b>	<b>4014586802855</b>	<b>01</b>	<b>1,672.00</b>

**Price includes:**

1 additional handle, 1 drift key

For accessories, see page 8

\* 230 V only



Type	Part number	EAN	PC	£ List Price excl. VAT
<b>DDSk 672*</b>	<b>7 202 06 00 22 9</b>	<b>4014586802749</b>	<b>01</b>	<b>1,976.00</b>

**Price includes:**  
1 additional handle, 1 drift key  
For accessories, see page 8  
\* 230 V only



Type	Part number	EAN	PC	£ List Price excl. VAT
<b>DDSk 672-1</b>	<b>7 205 01 00 22 8</b>	<b>4014586804453</b>	<b>01</b>	<b>2,042.00</b>

**Price includes:**  
1 additional handle, 1 drift key  
For accessories, see page 8



Type	Part number	EAN	PC	£ List Price excl. VAT
<b>ASq 672-1*</b>	<b>7 205 03 00 22 0</b>	<b>4014586804569</b>	<b>01</b>	<b>2,305.00</b>

**Price includes:**  
1 additional handle, 1 drift key, 1 suspension eyelet  
For accessories, see page 8  
\* 230 V only

**Drills**

**Accessories for (A)BOP 6, (A)BOP 10, (A)BOP 10-2, (A)BOP 13-2**



**Tool case**  
With case insert and plastic box  
Plastic, inner dimensions: 470 x 275 x 116 mm

Part number	£ List Price excl. VAT
3 39 01 118 48 0	50.95



**Quick charger ALG 50**  
For all FEIN Li-ion batteries. Charge time from 35 min.

Part number	£ List Price excl. VAT
9 26 04 129 01 0	45.53



**Quick charger ALG 30**  
For FEIN NiCd and Li-ion batteries. Charge time from 25 min.

Part number	£ List Price excl. VAT
9 26 04 096 01 0	163.10



**Battery pack**  
Li-ion battery with charge status indicator and FEIN SafetyCell technology. Protects the battery and tool from overload, overheating and total discharge. Can be used with all FEIN 18 V cordless tools.

Current/Voltages V	Capacity Ah	Part number	£ List Price excl. VAT
18	5	9 26 04 173 02 0	111.38
18	2,5	9 26 04 171 02 0	76.34



**Battery starter set**  
2 x Li-ion batteries with ALG 50 rapid charger.

Current/ Voltages V	Capacity Ah	Part number	£ List Price excl. VAT
18	5	9 26 04 301 03 0	268.29
18	2,5	9 26 04 301 04 0	197.14



**Quick-action chucks**  
Single sheath metal SUPRA SKE quick clamping drill chuck with locking force safety device, drill chuck holder 1/2"-20 UNF

Chuck opening mm	Part number	£ List Price excl. VAT
0.5 - 10	6 32 05 036 01 0	76.33



**Quick-action chucks**  
Single sheath metal SUPRA SKE quick clamping drill chuck with locking force safety device, drill chuck holder 1/2"-20 UNF

Chuck opening mm	Part number	£ List Price excl. VAT
1.5-13	6 32 05 035 01 0	73.10

**Jaw spanner SW17**

Part number	£ List Price excl. VAT
6 29 03 002 00 9	6.40



**Suspension Device**  
for hooking onto a balancer horizontal and vertical

Part number	£ List Price excl. VAT
3 21 25 050 00 7	11.09

**Depth stop**

Part number	£ List Price excl. VAT
3 21 27 005 00 6	7.91

**Protective cover**  
for protecting the work piece surface from mechanical damages

Model	Part number	£ List Price excl. VAT
BOP 10	3 14 20 131 01 0	11.71
BOP 10-2/13-2	3 14 20 132 01 0	11.71

**Cutting paste**  
Lubricating agents for working on sheet metals.

Part number	£ List Price excl. VAT
3 21 32 020 12 9	15.48

**Accessories for BOS 16, BOS 16-2**

**Tool case**  
Plastic, inner dimensions: 470 x 275 x 116 mm

Part number	£ List Price excl. VAT
3 39 01 118 01 0	46.09

**Paddle**  
Length 600 mm, Ø 110 mm

Part number	£ List Price excl. VAT
6 39 02 002 01 3	92.08

**Quick-action chucks**  
Single sheath metal SUPRA SKE quick clamping drill chuck with locking force safety device, drill chuck holder 1/2"-20 UNF

Chuck opening mm	Weight kg	Part number	£ List Price excl. VAT
3-16	0,56	6 32 05 038 01 0	107.43

**Quick-action chucks**  
Drill chuck holder 1/2"-20 UNF form R tip

Chuck opening mm	Weight kg	Part number	£ List Price excl. VAT
1-13	0,54	6 32 05 033 01 0	91.24

**Key-type drill chucks**  
Drill chuck holder 1/2"-20 UNF

Chuck opening mm	Weight kg	Part number	£ List Price excl. VAT
1-10	0,3	6 32 03 034 01 0	34.97
1,5-13	0,38	6 32 03 041 01 4	43.93

**Accessories for DSke 672, DDSk 671-1, DDSk 672**

**Tool case**  
metal 400 x 400 x 130 mm

Part number	£ List Price excl. VAT
3 39 01 032 01 3	56.43

**Quick-action chucks**  
Drill chuck holder B 16 form R tip

Chuck opening mm	Weight kg	Part number	£ List Price excl. VAT
0-10	0,61	6 32 04 016 00 7	70.68
1-13	0,88	6 32 04 017 00 1	85.41
3-16	1,14	6 32 04 025 00 3	100.64

**Quick-action chucks**  
Drill chuck holder B 16 R shaped tip with locking force safety device

Chuck opening mm	Weight kg	Part number	£ List Price excl. VAT
1-13	0,56	6 32 04 032 00 6	91.69

**Key-type drill chucks**  
Drill chuck holder B 16

Chuck opening mm	Weight kg	Part number	£ List Price excl. VAT
1.5-13	0,41	6 32 02 030 01 5	48.44
1-16	0,64	6 32 02 037 01 0	68.31

**Morse taper arbors**  
for drilling machines with morse taper arbor

Mount	Part number	£ List Price excl. VAT
MT 3/B 16	6 33 01 012 00 5	13.93
MT 3/B 22	6 33 01 014 00 7	18.90

**Enlargement tapers**  
for M.T. sockets

Mount	Part number	£ List Price excl. VAT
MT 3/MT 4	6 33 04 004 00 0	109.01

**Reducing sleeves**  
for M.T. sockets

Part number	£ List Price excl. VAT
6 33 02 003 00 4	16.57

**Drift keys**

Mount	Length mm	Part number	£ List Price excl. VAT
MT 1/MT 2	140	6 33 05 003 00 3	4.62
MT 3/MT 4	190	6 33 05 004 00 1	6.79

**Accessories for ASq 672-1**

**Key-type drill chucks**  
Drill chuck holder B 22

Chuck opening mm	Outer Ø mm	Drill chuck holder	Weight kg	Part number	£ List Price excl. VAT
5-20	75	B 22	1,55	6 32 02 022 01 8	110.90

**Morse taper arbors**  
for drilling machines with morse taper arbor

Mount	Part number	£ List Price excl. VAT
MT 4/B 22	6 33 01 016 00 4	36.18

**Reducing sleeves**  
for M.T. sockets

Mount	Part number	£ List Price excl. VAT
MT 4/MT 3	6 33 02 004 00 2	22.59

**Accessories for ASq 672-1, DSke 672, DDSk 672-1, DDSk 672**

**Safety slipping clutch**  
with MT 3 -socket and output Ø 30 mm, adjusting range 15-80 Nm for speed range 0-500 rpm., weight 2,2 kg, incl. rubber ring, cylindrical pin, clamping sleeve and hook spanner

Part number	£ List Price excl. VAT
9 01 05 002 01 8	1,034.13



	<b>AWBP 10 Select</b>	<b>WBP 10</b>	
	Extremely small cordless angle drill for working in difficult-to-reach spots.	Extremely small angle drill for working in difficult-to-reach spots.	
<b>EAN 4014586...</b>	... 881775	... 878843	
<b>Page</b>	11	11	
<b>Technical features</b>	Input	500 W	
	Output	270 W	
	Battery voltage	18 V	
	Battery compatibility	Li-ion / HighPower Li-ion	
	Battery interface	18 V	
	Speed, full load	0 - 1 260 1/min	0 - 1 030 1/min
	Speed, no load	0 - 1 370 1/min	0 - 1 830 1/min
	Capacity in steel Ø	10 mm	10 mm
	capacity in Ø stainless steel	10 mm	10 mm
	Capacity in alu Ø	15 mm	15 mm
	Capacity in wood Ø	25 mm	25 mm
	Tapping	M 6	M 6
	Width across corners	17 mm	17 mm
	Weight according to EPTA		1,50 kg
Weight without storage battery	1,30 kg		

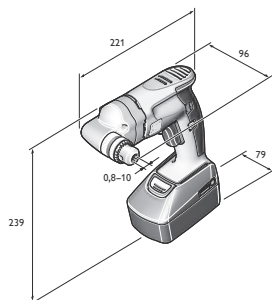

AWBP 10

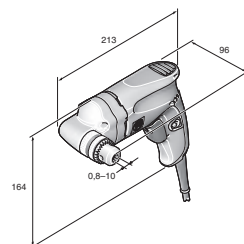

WBP 10



**FEIN SELECT<sup>+</sup>**



Type	Part number	EAN	PC	£ List Price excl. VAT
<b>AWBP 10 Select</b>	<b>7 105 04 62 00 0</b>	<b>4014586881775</b>	<b>01</b>	<b>375.00</b>

**Price includes:**  
1 3-jaw chuck up to Ø 10 mm, 1 drill chuck key, 1 plastic carrying case  
For accessories, see page 11



Type	Part number	EAN	PC	£ List Price excl. VAT
<b>WBP 10*</b>	<b>7 205 51 60 00 0</b>	<b>4014586878843</b>	<b>01</b>	<b>447.00</b>

**Price includes:**  
1 3-jaw chuck up to Ø 10 mm, 1 drill chuck key  
For accessories, see page 11

\* 230 V only

**Angle drills**

**General accessories**



**Key-type drill chucks**  
Drill chuck holder B 10

Chuck opening mm	Weight kg	Part number	£ List Price excl. VAT
0,8-10	0,22	6 32 02 044 01 8	36.61
0,5-8	0,14	6 32 02 043 01 0	40.62



**Quick charger ALG 30**  
For FEIN NiCd and Li-ion batteries. Charge time from 25 min.

Part number	£ List Price excl. VAT
9 26 04 096 01 0	163.10



**Quick charger ALG 50**  
For all FEIN Li-ion batteries. Charge time from 35 min.

Part number	£ List Price excl. VAT
9 26 04 129 01 0	45.53

**Accessories for AWBP 10**



**Tool case**  
With case insert and plastic box

Part number	£ List Price excl. VAT
3 39 01 131 94 0	50.27



**Battery pack**  
Li-ion battery with charge status indicator and FEIN SafetyCell technology. Protects the battery and tool from overload, overheating and total discharge. Can be used with all FEIN 18 V cordless tools.

Current/Voltages V	Capacity Ah	Part number	£ List Price excl. VAT
18	5	9 26 04 173 02 0	111.38
18	2,5	9 26 04 171 02 0	76.34



**Battery starter set**  
2 x Li-ion batteries with ALG 50 rapid charger.

Current/Voltages V	Capacity Ah	Part number	£ List Price excl. VAT
18	5	9 26 04 301 03 0	268.29
18	2,5	9 26 04 301 04 0	197.14

**Accessories for WBP 10**



**Tool case**  
Plastic, inner dimensions: 470 x 275 x 116 mm

Part number	£ List Price excl. VAT
3 39 01 118 01 0	46.09



**Plastic box**  
Box insert with lockable lid for small parts and accessories, suitable for tool box 3 39 01 118 01 0, max 5 items/box.

Part number	£ List Price excl. VAT
3 39 01 119 00 0	4.54



	<b>IBS 16</b>	<b>MBS 32 F</b>	
	Industrial drill jig for drills with drilling capacity of up to 16 mm.	Flexible magnetic drill jig with fine adjustment for rotary drills with up to 32 mm drill capacity.	
<b>EAN 4014586...</b>	... 878515	... 847924	
<b>Page</b>	13	13	
<b>Technical features</b>	Twist drill max. Ø	16 mm	32 mm
	Reaming max. Ø	16 mm	40 mm
	Swivel range for drill jigs		350°
	Adjustment range for drill jigs		10 mm
	Tapping	M 12	M 24
	For collar Ø	53 mm	63 mm
	Stroke	145 mm	178 mm
	Total stroke range	295 mm	365 mm
	Magnetic foot dimensions		220 x 100 mm
	Magnetic holding power		18 000 N
Weight according to EPTA	8,00 kg	21,80 kg	

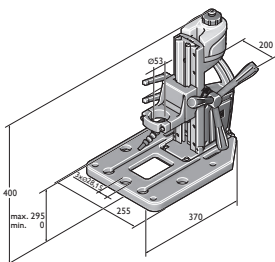

IBS 16

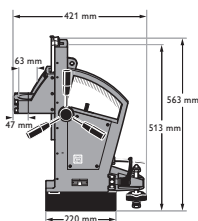

MBS 32 F



Type	Part number	EAN	PC	£ List Price excl. VAT
<b>IBS 16*</b>	<b>9 03 20 223 00 0</b>	<b>4014586878515</b>	<b>01</b>	<b>590.00</b>

**Price includes:**

1 coolant tank, 1 flex-jointed hose, 1 reducing ring, diameter 43 mm

For accessories, see page 14

\* 230 V only



Type	Part number	EAN	PC	£ List Price excl. VAT
<b>MBS 32 F*</b>	<b>9 03 16 223 00 8</b>	<b>4014586847924</b>	<b>01</b>	<b>3,276.00</b>

**Price includes:**

1 clamping strap, 1 swarf hook, 1 swarf guard, 2 keys

For accessories, see page 14

\* 230 V only

**Accessories for IBS 16**



**Reducing rings**  
for attaching machines with collar Ø 43 mm  
FEIN BOS, KBH

Ø mm	Part number	£ List Price excl. VAT
53 / 43	3 26 23 014 01 0	36.83

**Prism vice**

Part number	£ List Price excl. VAT
9 07 01 002 01 0	116.83

**Vice installation kit**

Part number	£ List Price excl. VAT
6 41 31 019 01 0	29.38

**Adapter plate for magnetic core drills**

Part number	£ List Price excl. VAT
3 24 22 326 01 0	47.89

**Accessories for MBS 16 X**



**Reducing rings**  
for attaching machines with collar Ø 33 mm.

Ø mm	Part number	£ List Price excl. VAT
43 / 33	3 26 23 012 01 9	37.80



**Reducing rings**  
for attaching machines with collar Ø 38 mm

Ø mm	Part number	£ List Price excl. VAT
43 / 38	3 26 23 013 00 4	29.56

**Accessories for MBS 25 F**



**Reducing rings**  
for attaching machines with collar Ø 38 mm

Ø mm	Part number	£ List Price excl. VAT
53 / 38	3 26 23 010 00 8	36.83



**Reducing rings**  
for attaching machines with collar Ø 43 mm

Ø mm	Part number	£ List Price excl. VAT
53 / 43	3 26 23 009 00 6	36.83



**Reducing rings**  
for attaching machines with collar Ø 43 mm  
FEIN BOS, KBH

Ø mm	Part number	£ List Price excl. VAT
53 / 43	3 26 23 014 01 0	36.83

**Accessories for MBS 16 X, MBS 25 F, MBS 32 F**



**Suction plate**  
for anti-magnetic materials, 250 x 330 x 110 mm

Part number	£ List Price excl. VAT
9 26 02 054 01 6	523.63



**Vacuum plate**  
for anti-magnetic materials and structured bases (corrugated sheet, stud plate etc.)  
Vacuum plate 396 x 200 x 95 mm

Part number	£ List Price excl. VAT
9 26 02 057 01 7	544.10



**Pipe drilling device**  
incl. clamping strap, for positioning bores on pipes with  
pipe Ø of 60 to 300 mm, 220 x 130 mm.

Part number	£ List Price excl. VAT
9 26 02 055 01 0	291.04



**Vacuum pump**  
Suction rate 0,015 m<sup>3</sup>/min, -0,8 bar, 92 W, weight 2,5 kg  
including suction hose

Part number	£ List Price excl. VAT
9 26 01 022 01 3	571.86





	<b>AGWP 10 Select</b>	<b>GWP 10</b>	
	Fast, accurate thread drill with reversing gear for shorter working times.	Fast, accurate thread drill with reversing gear for shorter working times.	
<b>EAN 4014586...</b>	... 885537	... 881256	
<b>Page</b>	16	16	
<b>Technical features</b>	Input	450 W	
	Output	250 W	
	Battery voltage	18 V	
	Battery compatibility	Li-ion / HighPower Li-ion	
	Battery interface	18 V	
	Idling speed in reverse running	0 - 760 1/min	0 - 1 000 1/min
	Load speed when cutting	0 - 440 1/min	0 - 450 1/min
	Load speed in reverse running	0 - 670 1/min	0 - 680 1/min
	Torque at max. output power	26 Nm	21 Nm
	Thread in steel up to	M 10	M 10
	Thread in stainless steel	M 10	M 10
	Cone at drill shaft	B 12	B 12
	Weight according to EPTA		1,60 kg
Weight without storage battery	1,30 kg		

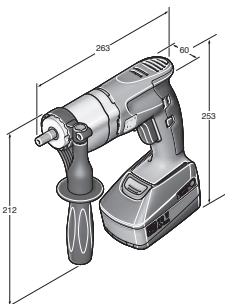

AGWP 10 Select

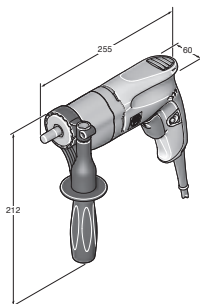

GWP 10

**FEIN SELECT<sup>+</sup>**



Type	Part number	EAN	PC	£ List Price excl. VAT
<b>AGWP 10 Select</b>	<b>7 109 01 62 00 0</b>	<b>4014586885537</b>	<b>01</b>	<b>470.00</b>

**Price includes:**  
1 additional handle, 1 plastic carrying case, **Threaded chuck not included**

For accessories, see page 16



Type	Part number	EAN	PC	£ List Price excl. VAT
<b>GWP 10</b>	<b>7 209 38 60 00 0</b>	<b>4014586881256</b>	<b>01</b>	<b>794.00</b>

**Price includes:**  
1 additional handle, **Threaded chuck not included**

For accessories, see page 16

**Tappers**

**General accessories**



**Quick charger ALG 50**  
For all FEIN Li-ion batteries. Charge time from 35 min.

Part number	£ List Price excl. VAT
9 26 04 129 01 0	45.53



**Quick charger ALG 30**  
For FEIN NiCd and Li-ion batteries. Charge time from 25 min.

Part number	£ List Price excl. VAT
9 26 04 096 01 0	163.10



**Battery pack**  
Li-ion battery with charge status indicator and FEIN SafetyCell technology. Protects the battery and tool from overload, overheating and total discharge. Can be used with all FEIN 18 V cordless tools.

Current/Voltages V	Capacity Ah	Part number	£ List Price excl. VAT
18	5	9 26 04 173 02 0	111.38
18	2,5	9 26 04 171 02 0	76.34



**Battery starter set**  
2 x Li-ion batteries with ALG 50 rapid charger.

Current/Voltages V	Capacity Ah	Part number	£ List Price excl. VAT
18	5	9 26 04 301 03 0	268.29
18	2,5	9 26 04 301 04 0	197.14



**Tool case**  
With case insert and plastic box  
Plastic, inner dimensions: 470 x 275 x 116 mm

Part number	£ List Price excl. VAT
3 39 01 131 08 0	52.81



**Collet chuck**  
with collets 3,5/4,5/6 mm

Part number	£ List Price excl. VAT
6 32 06 063 01 2	93.70



**Floating collet chuck**  
with collets 3,5/4,5/6 mm

Part number	£ List Price excl. VAT
6 32 06 076 02 2	146.97



**Collets**  
for collet chucks and floating collet chucks and tapping adapters.  
M2 (DIN 352, DIN 371), M4 (DIN 357, DIN 376)

Ø mm	Square mm	Part number	£ List Price excl. VAT
2,8	2,1	6 32 06 077 00 1	26.03



**Collets**  
for collet chucks and floating collet chucks and tapping adapters.  
M3 (DIN 352, DIN 371), M5 (DIN 357, DIN 376)

Ø mm	Square mm	Part number	£ List Price excl. VAT
3,5	2,7	6 32 06 064 00 1	26.03



**Collets**  
for collet chucks and floating collet chucks and tapping adapters.  
M4 (DIN 352, DIN 371), M6 (DIN 357, DIN 376)

Ø mm	Square mm	Part number	£ List Price excl. VAT
4,5	3,4	6 32 06 065 00 5	26.03



**Collets**  
for collet chucks and floating collet chucks and tapping adapters.  
M5 (DIN 352, DIN 371), M6 (DIN 352), M7 (DIN 352),  
M8 (DIN 352, DIN 357, DIN 376)

Ø mm	Square mm	Part number	£ List Price excl. VAT
6	4,9	6 32 06 066 00 8	26.03



**Collets**  
for collet chucks and floating collet chucks and tapping adapters.  
M7 (DIN 371), M9 (DIN 352) M 10 (DIN 352, DIN 357,  
DIN 376)

Ø mm	Square mm	Part number	£ List Price excl. VAT
7	5,5	6 32 06 070 00 6	26.03

**Collets**for collet chucks and floating collet chucks and tapping adapters.  
M8 (DIN 371), M11 (DIN 352)

Ø mm	Square mm	Part number	£ List Price excl. VAT
8	6,2	6 32 06 078 00 9	26.03

**Collets**for collet chucks and floating collet chucks and tapping adapters.  
M10 (DIN 371)

Ø mm	Square mm	Part number	£ List Price excl. VAT
10	8	6 32 06 079 00 3	25.29

**Collets**for collet chucks and floating collet chucks and tapping adapters.  
M12 (DIN 357, DIN 371, DIN 376)

Ø mm	Square mm	Part number	£ List Price excl. VAT
9	7	6 32 06 075 00 4	26.03

**Jaw chuck**for tapping drill direct adaptor clamping range 2.8 - 9.0 mm,  
with key wrench

Part number	£ List Price excl. VAT
6 32 06 019 00 9	95.56

**Floating jaw chuck**for tapping drill direct adaptor clamping range 2.8 - 9.0 mm,  
with key wrench

Part number	£ List Price excl. VAT
6 32 06 041 00 8	141.01

**Drifts**

for drill chuck up to B12, length 125 mm, pack of 2

Mount	Length mm	Part number	£ List Price excl. VAT
B 12	125	6 33 05 009 01 3	31.67

**Depth stop**£ List Price  
excl. VAT

Part number	£ List Price excl. VAT
3 21 27 005 00 6	7.91

**Cutting paste**

Lubricating agents for working on sheet metals.

Part number	£ List Price excl. VAT
3 21 32 020 12 9	15.48

**Accessories for GWP 10****Suspension Device**for hooking onto a balancer  
horizontal and vertical

Part number	£ List Price excl. VAT
3 21 25 050 00 7	11.09



## Reliable connections: the FEIN screwdriver range.

Extremely reliable and custom-made for the intended application, FEIN power screwdrivers produce top-class results and optimum screw connection quality - even in the toughest conditions. Whether in industrial volume production, metal construction, or interior work and renovation. Other benefits of FEIN power screwdrivers include exemplary ergonomics and very low weight, so you can achieve professional, efficient long-lasting results.



<b>Drill/Driver</b>	<b>Page</b>	<b>20</b>
The optimum combination of flexibility, power and reliability. Designed for drilling, tapping and screwdriving in metal.		
<b>Cordless impact wrench/driver</b>	<b>Page</b>	<b>26</b>
Unbeatably efficient and always reliable. Wide ranges of use and can withstand permanent loads.		
<b>FEIN AccuTec</b>	<b>Page</b>	<b>30</b>
Long-life precision cordless drill/driver for soft and hard screw connections in industrial volume production.		
<b>Metal screw gun</b>	<b>Page</b>	<b>37</b>
For safe, consistent working with self-drilling and thread-moulding screws in roof and facade construction as well as heating, air conditioning and ventilation.		
<b>Dry wall screw guns</b>	<b>Page</b>	<b>39</b>
The specialist tools for drywall and interior applications. Lightweight, ergonomic and compact for optimum results.		



	ASCM 18 QM	ASCM 18 QM Select	Professional set for ASCM 18 QM tapping	ABS 18 QC	ABS 18 Q Select	Professional set for ABS 18 QC tapping	ASB 18 QC	
	4-speed cordless drill/driver with brushless motor and QuickIN MAX interface. No compromise on performance for drilling and tapping up to 12 mm and drilling with carbide hole saws.		4-speed cordless drill/driver with brushless motor, QuickIN MAX interface and extensive accessories for drilling, tapping and screwdriving in metal.	2-speed cordless drill/driver with brushless motor and QuickIN interface. Perfectly suited to drilling and tapping up to 10 mm.		2-speed cordless drill/driver with brushless motor, QuickIN interface and extensive accessories for drilling, tapping and screwdriving in metal.	2-speed cordless hammer drill/driver with brushless motor and QuickIN interface. Perfectly suited to drilling up to 10 mm in metal, stone and masonry.	
<b>EAN 4014586...</b>	... 887326	... 887340	... 887333	... 887180	... 887203	... 887197	... 887241	
<b>Page</b>	22	22	22	22	22	22	22	
<b>Technical features</b>	Battery voltage	18 V	18 V	18 V	18 V	18 V	18 V	
	Battery capacity	5 Ah		5 Ah	2,5 Ah		2,5 Ah	
	Battery compatibility	Li-ion/ HighPower Li-ion	Li-ion/ HighPower Li-ion	Li-ion/ HighPower Li-ion	Li-ion/ HighPower Li-ion	Li-ion/ HighPower Li-ion	Li-ion/ HighPower Li-ion	Li-ion/ HighPower Li-ion
	Battery interface	18 V	18 V	18 V	MultiVolt	MultiVolt	MultiVolt	MultiVolt
	Motor	brushless	brushless	brushless	brushless	brushless	brushless	brushless
	Gearbox	4-speed	4-speed	4-speed	2-speed	2-speed	2-speed	2-speed
	Interface	QuickIN MAX	QuickIN MAX	QuickIN MAX	QuickIN	QuickIN	QuickIN	QuickIN
	Impacts							7 360 / 32 000 1/min
	Max. torque (hard/soft)	90 / 45 Nm	90 / 45 Nm	90 / 45 Nm	60 / 32 Nm	60 / 32 Nm	60 / 32 Nm	60 / 32 Nm
	Torque levels	15 + 1	15 + 1	15 + 1	22 + 1	22 + 1	22 + 1	22 + 1
	Capacity in steel Ø	25 mm	25 mm	25 mm	13 mm	13 mm	13 mm	13 mm
	Capacity in wood Ø	50 mm	50 mm	50 mm	50 mm	50 mm	50 mm	50 mm
	Capacity in stone Ø							13 mm
	Tapping	M 12	M 12	M 12	M 10	M 10	M 10	M 10
	Weight with battery	2,20 kg		2,20 kg	1,70 kg		1,70 kg	1,80 kg
	Weight without storage battery	1,50 kg	1,50 kg	1,50 kg	1,30 kg	1,30 kg	1,30 kg	1,30 kg
Removable drill chuck	●	●	●	●	●	●	●	

● included

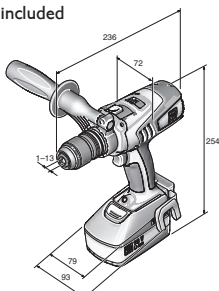

ASCM 18 QM

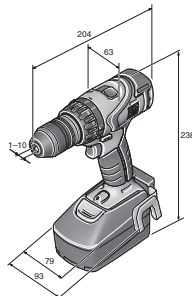

ABS 18 QC

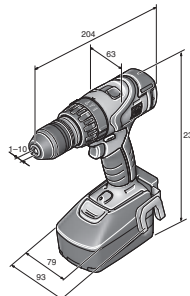

ASB 18 QC



	ASB 18 Q Select	Professional set for ASB 18 QC tapping	ASCM 12 QC	ASCM 12 Q Select	Professional set for ASCM 12 QC tapping	ABSU 12 C	ABSU 12 Select	ABSU 12 W4C	ABSU 12 W4 Select
		2-speed cordless hammer drill/driver with brushless motor, QuickIN interface and extensive accessories for drilling, tapping and screwdriving in metal.	4-speed cordless drill/driver with brushless motor and QuickIN interface. Perfectly suited to drilling and tapping up to 8 mm and screwdriving.		4-speed cordless drill/driver with brushless motor, QuickIN interface and extensive accessories for drilling, tapping and screwdriving in metal.	2-speed cordless drill/driver with solid metal drill chuck. Perfect for universal drilling and screwdriving up to 6 mm.		2-speed cordless drill/driver with 1/4" tool mounting. Powerful torque for screw connections up to 6 x 200 mm.	
	... 887265	... 887258	... 882390	... 885698	... 886961	... 881515	... 885568	... 881867	... 885575
	23	23	23	23	23	23	23	24	24
	18 V	18 V	12 V	12 V	12 V	12 V	12 V	12 V	12 V
		2,5 Ah	2,5 Ah		2,5 Ah	2,5 Ah		2,5 Ah	
	Li-ion/ HighPower Li-ion	Li-ion/ HighPower Li-ion	Li-ion	Li-ion	Li-ion	Li-ion	Li-ion	Li-ion	Li-ion
	MultiVolt	MultiVolt	12 V	12 V	12 V	12 V	12 V	12 V	12 V
	brushless	brushless	brushless	brushless	brushless	2-pole DC	2-pole DC	2-pole DC	2-pole DC
	2-speed	2-speed	4-speed	4-speed	4-speed	2-speed	2-speed	2-speed	2-speed
	QuickIN	QuickIN	QuickIN	QuickIN	QuickIN				
	7 360 / 32 000 1/min	7 360 / 32 000 1/min							
	60 / 32 Nm	60 / 32 Nm	40 / 20 Nm	40 / 20 Nm	40 / 20 Nm	20 / 14 Nm	20 / 14 Nm	20 / 14 Nm	20 / 14 Nm
	22 + 1	22 + 1	20 + 1	20 + 1	20 + 1	17 + 1	17 + 1	17 + 1	17 + 1
	13 mm	13 mm	13 mm	13 mm	13 mm	10 mm	10 mm		
	50 mm	50 mm	40 mm	40 mm	40 mm	30 mm	30 mm		
	13 mm	13 mm							
	M 10	M 10	M 8	M 8	M 8	M 6	M 6		
		1,80 kg	1,30 kg		1,30 kg	1,20 kg		1,10 kg	
	1,30 kg	1,30 kg	1,10 kg	1,10 kg	1,10 kg	1,00 kg	1,00 kg	0,80 kg	0,80 kg
	●	●	●	●	●				



Type	Part number	EAN	PC	£ List Price excl. VAT
<b>ASCM 18 QM</b>	<b>7 116 11 61 24 0</b>	<b>4014586887326</b>	<b>18</b>	<b>567.00</b>

**Price includes:**  
 2 battery packs (Li-ion), 1 rapid charger ALG 50, 1 QuickIN drill chuck (120 Nm), 1 belt clip, 1 bit holder, 1 handle,  
 1 plastic carrying case  
 For accessories, see page 24

**FEIN SELECT<sup>+</sup>**



Type	Part number	EAN	PC	£ List Price excl. VAT
<b>ASCM 18 QM Select</b>	<b>7 116 11 64 00 0</b>	<b>4014586887340</b>	<b>18</b>	<b>299.00</b>

**Price includes:**  
 1 QuickIN drill chuck (120 Nm), 1 belt clip, 1 bit holder, 1 handle, 1 plastic carrying case  
 For accessories, see page 24



Type	Part number	EAN	PC	£ List Price excl. VAT
<b>Professional set for ASCM 18 QM tapping</b>	<b>7 116 11 63 00 0</b>	<b>4014586887333</b>	<b>18</b>	<b>683.00</b>

**Price includes:**  
 2 battery packs (Li-ion), 1 rapid charger ALG 50, 1 QuickIN drill chuck (120 Nm), 1 belt clip, 1 bit holder, 1 handle,  
 1 plastic carrying case, 1 QuickIN bit holder (1/4"), 1 QuickIN tapping adapter with 2 collets, 1 QuickIN socket adapter (1/2")  
 For accessories, see page 24



Type	Part number	EAN	PC	£ List Price excl. VAT
<b>ABS 18 QC</b>	<b>7 113 22 62 24 0</b>	<b>4014586887180</b>	<b>18</b>	<b>450.00</b>

**Price includes:**  
 2 battery packs (Li-ion), 1 rapid charger ALG 50, 1 QuickIN drill chuck (120 Nm), 1 belt clip, 1 bit holder, 1 plastic carrying case  
 For accessories, see page 24

**FEIN SELECT<sup>+</sup>**



Type	Part number	EAN	PC	£ List Price excl. VAT
<b>ABS 18 Q Select</b>	<b>7 113 22 64 00 0</b>	<b>4014586887203</b>	<b>18</b>	<b>253.00</b>

**Price includes:**  
 1 QuickIN drill chuck (120 Nm), 1 belt clip, 1 bit holder, 1 plastic carrying case  
 For accessories, see page 24



Type	Part number	EAN	PC	£ List Price excl. VAT
<b>Professional set for ABS 18 QC tapping</b>	<b>7 113 22 63 00 0</b>	<b>4014586887197</b>	<b>18</b>	<b>566.00</b>

**Price includes:**  
 2 battery packs (Li-ion), 1 rapid charger ALG 50, 1 QuickIN drill chuck (120 Nm), 1 belt clip, 1 bit holder, 1 plastic carrying case,  
 1 QuickIN bit holder (1/4"), 1 QuickIN tapping adapter with 2 collets, 1 QuickIN socket adapter (1/2")  
 For accessories, see page 24



Type	Part number	EAN	PC	£ List Price excl. VAT
<b>ASB 18 QC</b>	<b>7 113 23 62 24 0</b>	<b>4014586887241</b>	<b>18</b>	<b>474.00</b>

**Price includes:**  
 2 battery packs (Li-ion), 1 rapid charger ALG 50, 1 QuickIN drill chuck (120 Nm), 1 belt clip, 1 bit holder, 1 plastic carrying case  
 For accessories, see page 24





**FEIN SELECT<sup>+</sup>**



Type	Part number	EAN	PC	£ List Price excl. VAT
<b>ASB 18 Q Select</b>	<b>7 113 23 64 00 0</b>	<b>4014586887265</b>	<b>18</b>	<b>276.00</b>

**Price includes:**  
1 QuickIN drill chuck (120 Nm), 1 belt clip, 1 bit holder, 1 plastic carrying case  
For accessories, see page 24



Type	Part number	EAN	PC	£ List Price excl. VAT
<b>Professional set for ASB 18 QC tapping</b>	<b>7 113 23 63 00 0</b>	<b>4014586887258</b>	<b>18</b>	<b>590.00</b>

**Price includes:**  
2 battery packs (Li-ion), 1 rapid charger ALG 50, 1 QuickIN drill chuck (120 Nm), 1 belt clip, 1 bit holder, 1 plastic carrying case, 1 QuickIN bit holder (1/4"), 1 QuickIN tapping adapter with 2 collets, 1 QuickIN socket adapter (1/2")  
For accessories, see page 24



Type	Part number	EAN	PC	£ List Price excl. VAT
<b>ASCM 12 QC</b>	<b>7 116 10 61 24 0</b>	<b>4014586882390</b>	<b>18</b>	<b>306.00</b>

**Price includes:**  
2 battery packs (Li-ion), 1 rapid charger ALG 50, 1 QuickIN drill chuck (60 Nm), 1 belt clip, 1 bit holder, 1 plastic carrying case  
For accessories, see page 24

**FEIN SELECT<sup>+</sup>**



Type	Part number	EAN	PC	£ List Price excl. VAT
<b>ASCM 12 Q Select</b>	<b>7 116 10 64 00 0</b>	<b>4014586885698</b>	<b>18</b>	<b>196.00</b>

**Price includes:**  
1 QuickIN drill chuck (60 Nm), 1 belt clip, 1 bit holder, 1 plastic carrying case  
For accessories, see page 24



Type	Part number	EAN	PC	£ List Price excl. VAT
<b>Professional set for ASCM 12 QC tapping</b>	<b>7 116 10 62 00 0</b>	<b>4014586886961</b>	<b>18</b>	<b>421.00</b>

**Price includes:**  
2 battery packs (Li-ion), 1 rapid charger ALG 50, 1 QuickIN drill chuck (60 Nm), 1 belt clip, 1 bit holder, 1 plastic carrying case, 1 QuickIN bit holder (1/4"), 1 QuickIN tapping adapter with 2 collets, 1 QuickIN socket adapter (1/2")  
For accessories, see page 24



Type	Part number	EAN	PC	£ List Price excl. VAT
<b>ABSU 12 C</b>	<b>7 113 20 61 24 0</b>	<b>4014586881515</b>	<b>18</b>	<b>204.00</b>

**Price includes:**  
2 battery packs (Li-ion), 1 rapid charger ALG 50, 1 belt clip, 1 bit holder, 1 plastic carrying case  
For accessories, see page 24

**FEIN SELECT<sup>+</sup>**



Type	Part number	EAN	PC	£ List Price excl. VAT
<b>ABSU 12 Select</b>	<b>7 113 20 64 00 0</b>	<b>4014586885568</b>	<b>18</b>	<b>95.00</b>

**Price includes:**  
1 belt clip, 1 bit holder, 1 plastic carrying case  
For accessories, see page 24



Type	Part number	EAN	PC	£ List Price excl. VAT
<b>ABSU 12 W4C</b>	<b>7 113 21 61 24 0</b>	<b>4014586881867</b>	<b>18</b>	<b>204.00</b>

**Price includes:**  
2 battery packs (Li-ion), 1 rapid charger ALG 50, 1 belt clip, 1 bit holder, 1 plastic carrying case  
For accessories, see page 24

**FEIN SELECT<sup>+</sup>**



Type	Part number	EAN	PC	£ List Price excl. VAT
<b>ABSU 12 W4 Select</b>	<b>7 113 21 64 00 0</b>	<b>4014586885575</b>	<b>18</b>	<b>90.00</b>

**Price includes:**  
1 belt clip, 1 bit holder, 1 plastic carrying case  
For accessories, see page 24

**Drill/Driver**

**General accessories**



**Cordless ALED 12-18 V LED lamp**  
Compact and durable cordless LED lamp with swivel-mounted lamp head. Compatible with all 12 / 14 / 18 V FEIN Li-ion batteries, including hook for attaching the lamp. Extremely lightweight at 130 g and very bright at 900 Lux. Colour temperature is the equivalent of daylight. The brightness can be set to 2 levels.

Part number	£ List Price excl. VAT
9 26 04 200 02 0	56.59



**Tool case**  
Plastic, inner dimensions: 470 x 275 x 116 mm

Part number	£ List Price excl. VAT
3 39 01 118 01 0	46.09



**Tool case**  
Suitable for ABSU 12, ASCD 12, ASCM 12

Part number	£ List Price excl. VAT
3 39 01 160 01 0	24.39



**Plastic box**  
Box insert with lockable lid for small parts and accessories, suitable for tool box 3 39 01 118 01 0, max 5 items/box.

Part number	£ List Price excl. VAT
3 39 01 119 00 0	4.54



**Quick charger ALG 50**  
For all FEIN Li-ion batteries. Charge time from 35 min.

Part number	£ List Price excl. VAT
9 26 04 129 01 0	45.53



**Quick charger ALG 30**  
For FEIN NiCd and Li-ion batteries. Charge time from 25 min.

Part number	£ List Price excl. VAT
9 26 04 096 01 0	163.10



**Tool holder 1/4" external hexagon**  
1/4" Drive-Hex Socket with quick-change chuck

Ø mm	L mm	Part number	£ List Price excl. VAT
15	51	6 05 10 011 00 9	20.81

**18 V battery**



**Battery pack**  
Li-ion battery with charge status indicator and FEIN SafetyCell technology. Protects the battery and tool from overload, overheating and total discharge. Can be used with all FEIN 18 V cordless tools.

Current/Voltages V	Capacity Ah	Part number	£ List Price excl. VAT
18	5	9 26 04 173 02 0	111.38
18	2,5	9 26 04 171 02 0	76.34



**Battery starter set**  
2 x Li-ion batteries with ALG 50 rapid charger.

Current/Voltages V	Capacity Ah	Part number	£ List Price excl. VAT
18	5	9 26 04 301 03 0	268.29
18	2,5	9 26 04 301 04 0	197.14

**12 V battery**



**Battery pack**  
Li-ion battery with charge status indicator and FEIN SafetyCell technology. Protects the battery and tool from overload, overheating and total discharge. Can be used with all FEIN 12 V cordless tools and 18 V cordless tools with MultiVolt interface.

Current/Voltages V	Capacity Ah	Part number	£ List Price excl. VAT
12	2,5	9 26 04 168 02 0	31.90



**Battery starter set**  
2 x Li-ion batteries with ALG 50 rapid charger.

Current/Voltages V	Capacity Ah	Part number	£ List Price excl. VAT
12	2,5	9 26 04 251 01 0	109.32



**Other accessories**



**Drill chuck**

Small solid metal drill chuck from Röhm, maximum torque 60 Nm.

Compatible with all FEIN cordless drill/drivers with QuickIN/QuickIN MAX interface.

Interface	Part number	£ List Price excl. VAT
QuickIN	6 32 08 002 01 0	39.71



**Drill chuck**

Solid metal drill chuck from Röhm with carbide-tipped clamping jaws and high clamping forces. Screwdriver bit may remain in the drive shaft, the drill chuck moves above the bit. Maximum torque 120 Nm.

Compatible with all FEIN cordless drill/drivers with QuickIN/QuickIN MAX interface.

Interface	Part number	£ List Price excl. VAT
QuickIN	6 32 08 005 01 0	46.84



**Bit holder**

1/4" hexagon socket bit holder with convenient one-handed operation and powerful neodymium magnet. Use of the bit holder makes the screwdriver lighter and shorter.

Compatible with all FEIN cordless drill/drivers with QuickIN/QuickIN MAX interface.

Interface	Part number	£ List Price excl. VAT
QuickIN	6 05 10 222 01 0	34.12



**Socket adapter**

Socket adapter to hold sockets with 1/2" square holder.

Compatible with all FEIN cordless drill/drivers with QuickIN/QuickIN MAX interface.

Interface	Part number	£ List Price excl. VAT
QuickIN	6 42 03 002 01 0	34.12



**Tapping adapter**

Tapping adapter with 2 collets for shank diameter of 4.5 mm and 6 mm to cut thread sizes M4 / M5 / M6 / M8. Reliable thread drill hold on the square, preventing slipping.

Compatible with all FEIN cordless drill/drivers with QuickIN/QuickIN MAX interface.

Interface	Part number	£ List Price excl. VAT
QuickIN	6 42 03 003 01 0	79.60



**Tapping adapter**

Reliable thread drill hold on the square, preventing slipping.

Compatible with all FEIN collets and all FEIN cordless drill/drivers with QuickIN/QuickIN MAX interface.

Interface	Part number	£ List Price excl. VAT
QuickIN	6 42 03 003 02 0	32.49



**Collets**

for collet chucks and floating collet chucks and tapping adapters. M2 (DIN 352, DIN 371), M4 (DIN 357, DIN 376)

Ø mm	Square mm	Part number	£ List Price excl. VAT
2,8	2,1	6 32 06 077 00 1	26.03



**Collets**

for collet chucks and floating collet chucks and tapping adapters. M3 (DIN 352, DIN 371), M5 (DIN 357, DIN 376)

Ø mm	Square mm	Part number	£ List Price excl. VAT
3,5	2,7	6 32 06 064 00 1	26.03



**Collets**

for collet chucks and floating collet chucks and tapping adapters. M4 (DIN 352, DIN 371), M6 (DIN 357, DIN 376)

Ø mm	Square mm	Part number	£ List Price excl. VAT
4,5	3,4	6 32 06 065 00 5	26.03



**Collets**

for collet chucks and floating collet chucks and tapping adapters. M5 (DIN 352, DIN 371), M6 (DIN 352), M7 (DIN 352), M8 (DIN 352, DIN 357, DIN 376)

Ø mm	Square mm	Part number	£ List Price excl. VAT
6	4,9	6 32 06 066 00 8	26.03



**Collets**

for collet chucks and floating collet chucks and tapping adapters. M7 (DIN 371), M9 (DIN 352) M 10 (DIN 352, DIN 357, DIN 376)

Ø mm	Square mm	Part number	£ List Price excl. VAT
7	5,5	6 32 06 070 00 6	26.03



**Collets**

for collet chucks and floating collet chucks and tapping adapters. M8 (DIN 371), M11 (DIN 352)

Ø mm	Square mm	Part number	£ List Price excl. VAT
8	6,2	6 32 06 078 00 9	26.03



**Collets**

for collet chucks and floating collet chucks and tapping adapters. M12 (DIN 357, DIN 371, DIN 376)

Ø mm	Square mm	Part number	£ List Price excl. VAT
9	7	6 32 06 075 00 4	26.03



**Collets**

for collet chucks and floating collet chucks and tapping adapters. M10 (DIN 371)

Ø mm	Square mm	Part number	£ List Price excl. VAT
10	8	6 32 06 079 00 3	25.29



	ASCD 18-300 W2	ASCD 18-300 W2 Select	ASCD 18-200 W4	ASCD 18-200 W4 Select	ASCD 12-150 W8C	
	Cordless impact wrench/driver with brushless motor and 6-stage torque setting. For metric screwdriving applications up to M18.		Impact wrench/driver with brushless motor and 6-stage torque setting. For universal screwdriving applications including self-drilling screwdriving.		Cordless impact wrench/driver with brushless motor and 6-stage torque setting. For metric screwdriving applications up to M14.	
<b>EAN 4014586...</b>	... 887517	... 887425	... 887531	... 887449	... 887470	
<b>Page</b>	28	28	28	28	28	
<b>Technical features</b>	Battery voltage	18 V	18 V	18 V	18 V	12 V
	Battery capacity	5 Ah		5 Ah		2,5 Ah
	Battery compatibility	Li-ion/ HighPower Li-ion	Li-ion/ HighPower Li-ion	Li-ion/ HighPower Li-ion	Li-ion/ HighPower Li-ion	Li-ion
	Battery interface	MultiVolt	MultiVolt	MultiVolt	MultiVolt	12 V
	Motor	brushless	brushless	brushless	brushless	brushless
	Speed, no load	0 - 1 700 1/min	0 - 1 700 1/min	0 - 1 500 1/min	0 - 1 500 1/min	0 - 1 800 1/min
	Impacts	0 - 3 400 1/min	0 - 3 400 1/min	0 - 3 000 1/min	0 - 3 000 1/min	0 - 3 600 1/min
	Max. torque	290 Nm	290 Nm	210 Nm	210 Nm	135 Nm
	Max. metric screw	M18 (8.8)	M18 (8.8)			M14 (8.8)
	Wood screw Ø	8 x 300 mm	8 x 300 mm	8 x 200 mm	8 x 200 mm	8 x 100 mm
	Weight with battery	1,70 kg		1,70 kg		1,10 kg
Weight without storage battery	1,00 kg	1,00 kg	1,00 kg	1,00 kg	0,85 kg	

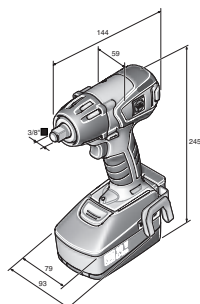

ASCD 18-300 W2

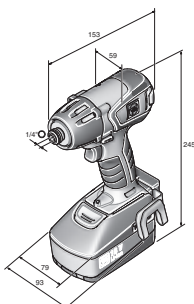

ASCD 18-200 W4

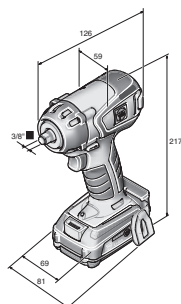

ASCD 12-150 W8C

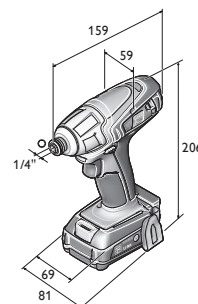

ASCD 12-100 W4C

	ASCD 12-150 W8 Select	ASCD 12-150 W4C	ASCD 12-150 W4 Select	ASCD 12-100 W4C	ASCD 12-100 W4 Select
		Impact wrench/driver with brushless motor and 6-stage torque setting. For universal screwdriving applications including self-drilling screwdriving.		Cordless impact wrench/driver with DC motor. For universal screw connections.	
	... 887388	... 887494	... 887401	... 881935	... 885582
	28	28	28	29	29
	12 V	12 V	12 V	12 V	12 V
		2,5 Ah		2,5 Ah	
	Li-ion	Li-ion	Li-ion	Li-ion	Li-ion
	12 V	12 V	12 V	12 V	12 V
	brushless	brushless	brushless	2-pole DC	2-pole DC
	0 - 1 800 1/min	0 - 1 700 1/min	0 - 1 700 1/min	0 - 2 700 1/min	0 - 2 700 1/min
	0 - 3 600 1/min	0 - 3 400 1/min	0 - 3 400 1/min	0 - 3 450 1/min	0 - 3 450 1/min
	135 Nm	135 Nm	135 Nm	100 Nm	100 Nm
	M14 (8.8)				
	8 x 100 mm	8 x 100 mm	8 x 100 mm	8 x 80 mm	8 x 80 mm
		1,10 kg		1,10 kg	
	0,85 kg	0,85 kg	0,85 kg	0,90 kg	0,90 kg

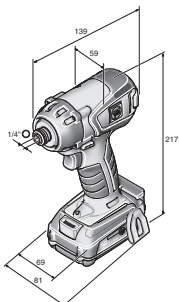

ASCD 12-150 W4



Type	Part number	EAN	PC	£ List Price excl. VAT
<b>ASCD 18-300 W2</b>	<b>7 115 06 61 24 0</b>	<b>4014586887517</b>	<b>18</b>	<b>567.00</b>

**Price includes:**

2 battery packs (Li-ion), 1 rapid charger ALG 50, 1 belt clip, 1 bit holder, 1 plastic carrying case

For accessories, see page 29

**FEIN SELECT<sup>+</sup>**

Type	Part number	EAN	PC	£ List Price excl. VAT
<b>ASCD 18-300 W2 Select</b>	<b>7 115 06 64 00 0</b>	<b>4014586887425</b>	<b>18</b>	<b>299.00</b>

**Price includes:**

1 belt clip, 1 bit holder, 1 plastic carrying case

For accessories, see page 29



Type	Part number	EAN	PC	£ List Price excl. VAT
<b>ASCD 18-200 W4</b>	<b>7 115 07 61 24 0</b>	<b>4014586887531</b>	<b>18</b>	<b>556.00</b>

**Price includes:**

2 battery packs (Li-ion), 1 rapid charger ALG 50, 1 belt clip, 1 bit holder, 1 plastic carrying case

For accessories, see page 29

**FEIN SELECT<sup>+</sup>**

Type	Part number	EAN	PC	£ List Price excl. VAT
<b>ASCD 18-200 W4 Select</b>	<b>7 115 07 64 00 0</b>	<b>4014586887449</b>	<b>18</b>	<b>287.00</b>

**Price includes:**

1 belt clip, 1 bit holder, 1 plastic carrying case

For accessories, see page 29



Type	Part number	EAN	PC	£ List Price excl. VAT
<b>ASCD 12-150 W8C</b>	<b>7 115 04 61 24 0</b>	<b>4014586887470</b>	<b>18</b>	<b>312.00</b>

**Price includes:**

2 battery packs (Li-ion), 1 rapid charger ALG 50, 1 belt clip, 1 bit holder, 1 plastic carrying case

For accessories, see page 29

**FEIN SELECT<sup>+</sup>**

Type	Part number	EAN	PC	£ List Price excl. VAT
<b>ASCD 12-150 W8 Select</b>	<b>7 115 04 64 00 0</b>	<b>4014586887388</b>	<b>18</b>	<b>193.00</b>

**Price includes:**

1 belt clip, 1 bit holder, 1 plastic carrying case

For accessories, see page 29



Type	Part number	EAN	PC	£ List Price excl. VAT
<b>ASCD 12-150 W4C</b>	<b>7 115 05 61 24 0</b>	<b>4014586887494</b>	<b>18</b>	<b>301.00</b>

**Price includes:**

2 battery packs (Li-ion), 1 rapid charger ALG 50, 1 belt clip, 1 bit holder, 1 plastic carrying case

For accessories, see page 29

**FEIN SELECT<sup>+</sup>**

Type	Part number	EAN	PC	£ List Price excl. VAT
<b>ASCD 12-150 W4 Select</b>	<b>7 115 05 64 00 0</b>	<b>4014586887401</b>	<b>18</b>	<b>182.00</b>

**Price includes:**

1 belt clip, 1 bit holder, 1 plastic carrying case

For accessories, see page 29



Type	Part number	EAN	PC	£ List Price excl. VAT
<b>ASCD 12-100 W4C</b>	<b>7 115 03 61 24 0</b>	<b>4014586881935</b>	<b>18</b>	<b>257.00</b>

**Price includes:**  
2 battery packs (Li-ion), 1 rapid charger ALG 50, 1 belt clip, 1 bit holder, 1 plastic carrying case  
For accessories, see page 29

**FEIN SELECT<sup>+</sup>**



Type	Part number	EAN	PC	£ List Price excl. VAT
<b>ASCD 12-100 W4 Select</b>	<b>7 115 03 64 00 0</b>	<b>4014586885582</b>	<b>18</b>	<b>149.00</b>

**Price includes:**  
1 belt clip, 1 bit holder, 1 plastic carrying case  
For accessories, see page 29

Fastening

**Cordless impact wrench/driver**

**General accessories**



**Cordless ALED 12-18 V LED lamp**  
Compact and durable cordless LED lamp with swivel-mounted lamp head. Compatible with all 12 / 14 / 18 V FEIN Li-ion batteries, including hook for attaching the lamp. Extremely lightweight at 130 g and very bright at 900 Lux. Colour temperature is the equivalent of daylight. The brightness can be set to 2 levels.

Part number	£ List Price excl. VAT
9 26 04 200 02 0	56.59



**Tool case**  
Plastic, inner dimensions: 470 x 275 x 116 mm

Part number	£ List Price excl. VAT
3 39 01 118 01 0	46.09



**Tool case**  
Suitable for ABSU 12, ASCD 12, ASCM 12

Part number	£ List Price excl. VAT
3 39 01 160 01 0	24.39



**Plastic box**  
Box insert with lockable lid for small parts and accessories, suitable for tool box 3 39 01 118 01 0, max 5 items/box.

Part number	£ List Price excl. VAT
3 39 01 119 00 0	4.54



**Quick charger ALG 50**  
For all FEIN Li-ion batteries. Charge time from 35 min.

Part number	£ List Price excl. VAT
9 26 04 129 01 0	45.53



**Quick charger ALG 30**  
For FEIN NiCd and Li-ion batteries. Charge time from 25 min.

Part number	£ List Price excl. VAT
9 26 04 096 01 0	163.10

**18 V battery**



**Battery pack**  
Li-ion battery with charge status indicator and FEIN SafetyCell technology. Protects the battery and tool from overload, overheating and total discharge. Can be used with all FEIN 18 V cordless tools.

Current/Voltages V	Capacity Ah	Part number	£ List Price excl. VAT
18	5	9 26 04 173 02 0	111.38
18	2,5	9 26 04 171 02 0	76.34



**Battery starter set**  
2 x Li-ion batteries with ALG 50 rapid charger.

Current/Voltages V	Capacity Ah	Part number	£ List Price excl. VAT
18	5	9 26 04 301 03 0	268.29
18	2,5	9 26 04 301 04 0	197.14

**12 V battery**



**Battery pack**  
Li-ion battery with charge status indicator and FEIN SafetyCell technology. Protects the battery and tool from overload, overheating and total discharge. Can be used with all FEIN 12 V cordless tools and 18 V cordless tools with MultiVolt interface.

Current/Voltages V	Capacity Ah	Part number	£ List Price excl. VAT
12	2,5	9 26 04 168 02 0	31.90



**Battery starter set**  
2 x Li-ion batteries with ALG 50 rapid charger.

Current/Voltages V	Capacity Ah	Part number	£ List Price excl. VAT
12	2,5	9 26 04 251 01 0	109.32



	ASM 14-2	ASM 14-6	ASM 14-9	ASM 14-12	ASM 14-2 PC	ASM 14-6 PC	ASM 14-9 PC	ASM 14-12 PC
	Certified screwdriver according to ISO 5393, VDI/VDE 2647, achieves CMK value > 1,67 at ± 10% (referred to 6 Sigma).				Programmable screwdrivers, tested for compliance with ISO 5393, VDI/VDE 2647, achieves CMK value > 1,67 at ± 10% (referred to 6 Sigma).			
<b>EAN 4014586...</b>	... 881294	... 876238	... 877211	... 877198	... 881317	... 874241	... 874258	... 874265
<b>Page</b>	31	31	31	31	31	31	31	31
<b>Technical features</b>	Battery voltage	14,4 V	14,4 V	14,4 V	14,4 V	14,4 V	14,4 V	14,4 V
	Torque range	0,5 - 2 Nm	1,2 - 6 Nm	2 - 9 Nm	3 - 12 Nm	0,5 - 2 Nm	1,2 - 6 Nm	2 - 9 Nm
	Speed, no load	350 1/min	600 1/min	600 1/min	500 1/min	50 - 700 1/min	50 - 950 1/min	50 - 700 1/min
	Tool Holder	1/4" hexagon socket	1/4" hexagon socket	1/4" hexagon socket	1/4" hexagon socket	1/4" hexagon socket	1/4" hexagon socket	1/4" hexagon socket
	Weight without storage battery	0,95 kg	0,95 kg	0,95 kg	0,95 kg	0,95 kg	0,95 kg	0,95 kg

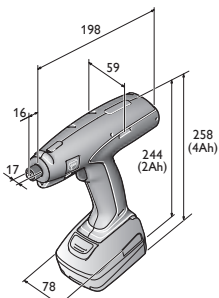

- ASM 14-2
- ASM 14-2 PC
- ASM 14-6
- ASM 14-6 PC
- ASM 14-9
- ASM 14-9 PC
- ASM 14-12
- ASM 14-12 PC





Type	Part number	EAN	PC	£ List Price excl. VAT
<b>ASM 14-2</b>	<b>7 112 60 00 95 0</b>	<b>4014586881294</b>	<b>05</b>	<b>POA</b>

**Price includes:**  
Supplied without battery, charger or torque wrench.  
For accessories, see page 35



Type	Part number	EAN	PC	£ List Price excl. VAT
<b>ASM 14-6</b>	<b>7 112 28 00 95 0</b>	<b>4014586876238</b>	<b>05</b>	<b>POA</b>

**Price includes:**  
Supplied without battery, charger or torque wrench.  
For accessories, see page 35



Type	Part number	EAN	PC	£ List Price excl. VAT
<b>ASM 14-9</b>	<b>7 112 59 00 95 0</b>	<b>4014586877211</b>	<b>05</b>	<b>POA</b>

**Price includes:**  
Supplied without battery, charger or torque wrench.  
For accessories, see page 35



Type	Part number	EAN	PC	£ List Price excl. VAT
<b>ASM 14-12</b>	<b>7 112 57 00 95 0</b>	<b>4014586877198</b>	<b>05</b>	<b>POA</b>

**Price includes:**  
Supplied without battery, charger or torque wrench.  
For accessories, see page 35



Type	Part number	EAN	PC	£ List Price excl. VAT
<b>ASM 14-2 PC</b>	<b>7 112 61 00 95 0</b>	<b>4014586881317</b>	<b>05</b>	<b>POA</b>

**Price includes:**  
Supplied without battery, charger or torque wrench.  
For accessories, see page 35



Type	Part number	EAN	PC	£ List Price excl. VAT
<b>ASM 14-6 PC</b>	<b>7 112 54 00 95 0</b>	<b>4014586874241</b>	<b>05</b>	<b>POA</b>

**Price includes:**  
Supplied without battery, charger or torque wrench.  
For accessories, see page 35



Type	Part number	EAN	PC	£ List Price excl. VAT
<b>ASM 14-9 PC</b>	<b>7 112 55 00 95 0</b>	<b>4014586874258</b>	<b>05</b>	<b>POA</b>

**Price includes:**  
Supplied without battery, charger or torque wrench.  
For accessories, see page 35



Type	Part number	EAN	PC	£ List Price excl. VAT
<b>ASM 14-12 PC</b>	<b>7 112 56 00 95 0</b>	<b>4014586874265</b>	<b>05</b>	<b>POA</b>

**Price includes:**  
Supplied without battery, charger or torque wrench.  
For accessories, see page 35



		ASW 14-6 PC	ASW 14-14 PC	ASW 18-6	ASW 18-12	ASW 18-18
		Programmable screwdrivers, tested for compliance with ISO 5393, VDI/VDE 2647, achieves CMK value > 1,67 at ± 10% (referred to 6 Sigma).		Certified screwdriver according to ISO 5393, VDI/VDE 2647, achieves CMK value > 1,67 at ± 10% (referred to 6 Sigma).		
<b>EAN 4014586...</b>		... 874210	... 874234	... 887906	... 887944	... 887982
<b>Page</b>		34	34	34	34	34
<b>Technical features</b>	Battery voltage	14,4 V	14,4 V	18 V	18 V	18 V
	Torque range	1.5 - 6 Nm	3 - 14 Nm	1.2 - 6 Nm	3 - 12 Nm	6 - 18 Nm
	Speed, no load	50 - 670 1/min	50 - 500 1/min	575 1/min	430 1/min	375 1/min
	Weight including angled head but not storage battery	1 kg	1 kg	1 kg	1 kg	1,2 kg

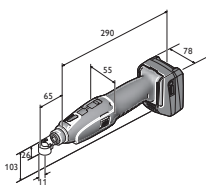

ASW 14-6  
ASW 14-6 PC  
ASW 14-10  
ASW 14-10 PC  
ASW 14-14  
ASW 14-14 PC

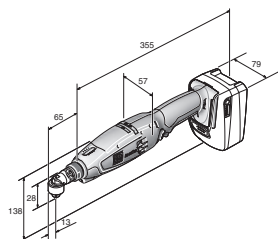

ASW 18-6

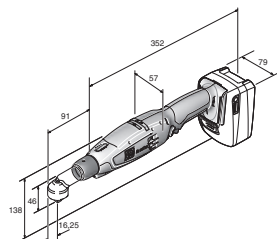

ASW 18-18 PC

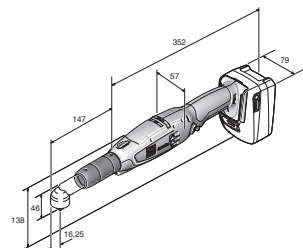

ASW 18-30 PC  
ASW 18-45 PC

	ASW 18-6 PC	ASW 18-12 PC	ASW 18-18 PC	ASW 18-30 PC	ASW 18-45 PC	ASW 18-60 PC
Programmable screwdrivers, tested for compliance with ISO 5393, VDI/VDE 2647, achieves CMK value > 1,67 at ± 10% (referred to 6 Sigma).						
	... 887920	... 887968	... 888002	... 883830	... 883847	... 883854
	34	34	34	34	35	35
	18 V	18 V	18 V	18 V	18 V	18 V
	1.2 - 6 Nm	3 - 12 Nm	6 - 18 Nm	12 - 30 Nm	20 - 45 Nm	25 - 60 Nm
	100 - 1 340 1/min	75 - 1 020 1/min	65 - 900 1/min	30 - 420 1/min	25 - 310 1/min	20 - 230 1/min
	1 kg	1 kg	1,2 kg	1,5 kg	1,5 kg	1,65 kg

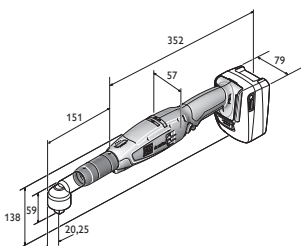

ASW 18-60 PC

£ List Price  
excl. VAT



Type	Part number	EAN	PC
<b>ASW 14-6 PC</b>	<b>7 112 50 00 95 0</b>	<b>4014586874210</b>	<b>05</b>

**Price includes:**  
Supplied without battery, charger, angled head or torque wrench.  
For accessories, see page 35

£ List Price  
excl. VAT



Type	Part number	EAN	PC
<b>ASW 14-14 PC</b>	<b>7 112 52 00 95 0</b>	<b>4014586874234</b>	<b>05</b>

**Price includes:**  
Supplied without battery, charger, angled head or torque wrench.  
For accessories, see page 35

£ List Price  
excl. VAT



Type	Part number	EAN	PC
<b>ASW 18-6</b>	<b>7 112 65 60 00 0</b>	<b>4014586887906</b>	<b>05</b>

**Price includes:**  
Supplied without battery, charger, angled head or torque wrench.  
For accessories, see page 35

£ List Price  
excl. VAT



Type	Part number	EAN	PC
<b>ASW 18-12</b>	<b>7 112 67 60 00 0</b>	<b>4014586887944</b>	<b>05</b>

**Price includes:**  
Supplied without battery, charger, angled head or torque wrench.  
For accessories, see page 35

£ List Price  
excl. VAT



Type	Part number	EAN	PC
<b>ASW 18-18</b>	<b>7 112 69 60 00 0</b>	<b>4014586887982</b>	<b>05</b>

**Price includes:**  
Supplied without battery, charger, angled head or torque wrench.  
For accessories, see page 35

£ List Price  
excl. VAT



Type	Part number	EAN	PC
<b>ASW 18-6 PC</b>	<b>7 112 66 60 00 0</b>	<b>4014586887920</b>	<b>05</b>

**Price includes:**  
Supplied without battery, charger, angled head or torque wrench.  
For accessories, see page 35

£ List Price  
excl. VAT



Type	Part number	EAN	PC
<b>ASW 18-12 PC</b>	<b>7 112 68 60 00 0</b>	<b>4014586887968</b>	<b>05</b>

**Price includes:**  
Supplied without battery, charger, angled head or torque wrench.  
For accessories, see page 35

£ List Price  
excl. VAT



Type	Part number	EAN	PC
<b>ASW 18-18 PC</b>	<b>7 112 70 60 00 0</b>	<b>4014586888002</b>	<b>05</b>

**Price includes:**  
Supplied without battery, charger, angled head or torque wrench.  
For accessories, see page 35

£ List Price  
excl. VAT



Type	Part number	EAN	PC
<b>ASW 18-30 PC</b>	<b>7 112 62 60 00 0</b>	<b>4014586883830</b>	<b>05</b>

**Price includes:**  
Supplied without battery, charger, angled head or torque wrench.  
For accessories, see page 35



Type	Part number	EAN	PC	£ List Price excl. VAT
<b>ASW 18-45 PC</b>	<b>7 112 63 60 00 0</b>	<b>4014586883847</b>	<b>05</b>	<b>POA</b>

**Price includes:**  
Supplied without battery, charger, angled head or torque wrench.  
For accessories, see page 35



Type	Part number	EAN	PC	£ List Price excl. VAT
<b>ASW 18-60 PC</b>	<b>7 112 64 60 00 0</b>	<b>4014586883854</b>	<b>05</b>	<b>POA</b>

**Price includes:**  
Supplied without battery, charger, angled head or torque wrench.  
For accessories, see page 35

**FEIN AccuTEC**

**General accessories**



**Battery pack**  
Li-ion battery with charge status indicator and FEIN SafetyCell technology. Protects the battery and tool from overload, overheating and total discharge. Can be used with all FEIN 12 V cordless tools and 18 V cordless tools with MultiVolt interface.

Current/Voltages V	Capacity Ah	Part number	£ List Price excl. VAT
12	2,5	9 26 04 168 02 0	31.90



**Battery pack**  
Li-ion with charge status indicator and FEIN SafetyCell Technology. Protects the battery and tool from overload, overheating and total discharge.

Current/Voltages V	Capacity Ah	No. in pack pcs	Part number	£ List Price excl. VAT
14,4	2,5	1	9 26 04 170 02 0	107.77
14,4	2,5	15	9 26 04 170 03 0	1,120.72
14,4	5	1	9 26 04 172 02 0	146.42
14,4	5	15	9 26 04 172 03 0	1,608.13



**Battery pack**  
Li-ion battery with charge status indicator and FEIN SafetyCell technology. Protects the battery and tool from overload, overheating and total discharge. Can be used with all FEIN 18 V cordless tools.

Current/Voltages V	Capacity Ah	No. in pack pcs	Part number	£ List Price excl. VAT
18	2,5	1	9 26 04 171 02 0	76.34
18	2,5	12	9 26 04 171 03 0	895.89
18	5	1	9 26 04 173 02 0	111.38
18	5	12	9 26 04 173 03 0	1,285.53



**Quick charger ALG 30**  
For FEIN NiCd and Li-ion batteries. Charge time from 25 min.

No. in pack pcs	Part number	£ List Price excl. VAT
1	9 26 04 096 01 0	163.10
25	9 26 04 096 03 0	3,480.13



**Multi-charger ALS 40**  
Mains cable not included.

Part number	£ List Price excl. VAT
9 26 04 111 01 0	1,681.44



**Charging adapter**  
For the battery interface of NiCd and NiMH batteries to ALS 40, ALG 40 and ALG 30.

Part number	£ List Price excl. VAT
9 26 04 103 01 0	17.07



**Adjustment spanner - torque**

Part number	£ List Price excl. VAT
3 21 23 002 00 6	8.46



**Battery cover**  
for protecting the work piece surface from mechanical damages for Li-Ion battery 14.4 V 2 / 2,5 Ah

Part number	£ List Price excl. VAT
3 21 74 015 01 0	17.61



**Battery cover**  
for protecting the work piece surface from mechanical damages for Li-Ion battery 14.4 V 4 / 5 Ah

Part number	£ List Price excl. VAT
3 21 74 016 01 0	18.73

**Battery cover**  
for protecting the work piece surface from mechanical damages for Li-Ion battery 18 V 2,5 Ah

Part number	£ List Price excl. VAT
3 21 74 020 01 0	20.89

**Battery cover**  
for protecting the work piece surface from mechanical damages for Li-Ion battery 18 V 5 Ah

Part number	£ List Price excl. VAT
3 21 74 019 01 0	22.05

**Battery cover**

for protecting the work piece surface from mechanical damages for Li-Ion battery 12 V 2,5 Ah

Part number	£ List Price excl. VAT
3 21 74 025 01 0	16.25



**Tool holder**

Tool storage for all FEIN AccuTEC models.

Part number	£ List Price excl. VAT
3 21 26 012 01 0	40.62

**ASM accessories**



**Protection for AccuTEC ASM**

for protecting the work piece surface from mechanical damages

Part number	£ List Price excl. VAT
3 14 20 120 01 0	20.99



**Coding sleeves**

for colour IDs of different models

Colour	No. in pack pcs	Part number	£ List Price excl. VAT
Colour mix	7	3 05 01 345 02 0	15.08
blue	10	3 05 01 348 01 0	17.32
red	10	3 05 01 349 01 0	17.32
orange	10	3 05 01 350 01 0	17.32
yellow	10	3 05 01 351 01 0	17.32
grey	10	3 05 01 346 01 0	17.32
green	10	3 05 01 347 01 0	17.32
black	10	3 05 01 345 01 0	17.32

**ASW accessories**



**Coding sleeves**

for colour IDs of different models

Colour	No. in pack pcs	Part number	£ List Price excl. VAT
Colour mix	7	3 05 01 352 02 0	14.39
blue	10	3 05 01 355 01 0	17.32
red	10	3 05 01 356 01 0	17.32
orange	10	3 05 01 357 01 0	17.32
yellow	10	3 05 01 358 01 0	17.32
grey	10	3 05 01 353 01 0	17.32
green	10	3 05 01 354 01 0	17.32
black	10	3 05 01 352 01 0	17.32



**AccuTEC ASW protective cover**

for protecting the work piece surface from mechanical damages

Model	Part number	£ List Price excl. VAT
ASW 14	3 21 74 014 01 0	17.61
ASW 18	3 21 74 024 01 0	29.43



**Plastic cover**

for protecting the work piece surface from mechanical damages

Model	Part number	£ List Price excl. VAT
<45 Nm	3 21 74 022 01 0	15.06
<60 Nm	3 21 74 021 01 0	15.06



**Extension**

To reduce the reaction torque and for better accessibility. 86 mm, for ASW 14-6 (PC), ASW 14-10 (PC), ASW 14-14 (PC).

Part number	£ List Price excl. VAT
6 42 03 004 01 0	59.03



**Extension**

To reduce the reaction torque and for better accessibility. 100 mm, for ASW18-30 PC, ASW18-45 PC and ASW18-60 PC.

Part number	£ List Price excl. VAT
6 42 03 005 01 0	118.08



**Handle**

for ASW14-30 PC, ASW18-30 PC, ASW18-45 PC and ASW18-60 PC.

Part number	£ List Price excl. VAT
3 21 19 150 01 0	46.96

**Accessories for ParameterControl models**



**Programming adapter**

For all AccuTEC ParameterControl models. Supplied: Software on USB card incl. instructions, adapter and connection cable.

Part number	£ List Price excl. VAT
9 26 04 163 02 0	452.83



	ASCS 6.3 Select	SCS 4.8-25	
	Speed-optimised cordless drill/driver for screw connections in metal up to a diameter of 6.3 mm.	One of the lightest self-drilling screwdriver in its class for roof and facade construction.	
<b>EAN 4014586...</b>	... 881461		
<b>Page</b>	38	38	
<b>Technical features</b>	Input	450 W	
	Battery voltage	18 V	
	Battery compatibility	Li-ion / HighPower Li-ion	
	Battery interface	18 V	
	Speed, no load	0 - 1 700 1/min	0 - 2 500 1/min
	Screw Ø	6,3 mm	4,8 mm
	Rapid change chuck	1/4"	1/4"
	Weight according to EPTA		1,30 kg
Weight without storage battery	1,10 kg		



ASCS 6.3

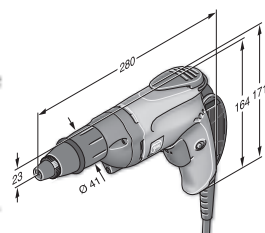

SCS 4.8-25

**FEIN SELECT<sup>+</sup>**



Type	Part number	EAN	PC	£ List Price excl. VAT
<b>ASCS 6.3 Select</b>	<b>7 113 11 63 00 0</b>	<b>4014586881461</b>	<b>01</b>	<b>304.00</b>

**Price includes:**  
1 hook, 1 depth stop, 1 insert for hexagon bolts SW 8, 1 plastic carrying case  
For accessories, see page 38



Type	Part number	PC	£ List Price excl. VAT
<b>SCS 4.8-25</b>	<b>7 213 04</b>	<b>01</b>	<b>419.00</b>

**Price includes:**  
1 depth stop, 1 magnetic holder for bits 1/4", 1 bit 1/4" for cross-slotted screws size 2 / Phillips (form H) extra hard, 1 hand strap, 1 belt clip  
For accessories, see page 38

**Metal screw gun**

**General accessories**



**Cordless ALED 12-18 V LED lamp**  
Compact and durable cordless LED lamp with swivel-mounted lamp head. Compatible with all 12 / 14 / 18 V FEIN Li-ion batteries, including hook for attaching the lamp. Extremely lightweight at 130 g and very bright at 900 Lux. Colour temperature is the equivalent of daylight. The brightness can be set to 2 levels.

Part number	£ List Price excl. VAT
9 26 04 200 02 0	56.59



**Tool case**  
Plastic, inner dimensions: 470 x 275 x 116 mm

Part number	£ List Price excl. VAT
3 39 01 118 01 0	46.09



**Plastic box**  
Box insert with lockable lid for small parts and accessories, suitable for tool box 3 39 01 118 01 0, max 5 items/box.

Part number	£ List Price excl. VAT
3 39 01 119 00 0	4.54



**Quick charger ALG 50**  
For all FEIN Li-ion batteries. Charge time from 35 min.

Part number	£ List Price excl. VAT
9 26 04 129 01 0	45.53



**Quick charger ALG 30**  
For FEIN NiCd and Li-ion batteries. Charge time from 25 min.

Part number	£ List Price excl. VAT
9 26 04 096 01 0	163.10



**Tool holder 1/4" external hexagon**  
1/4" Drive-Hex Socket  
with quick-change chuck

Ø mm	L mm	Part number	£ List Price excl. VAT
15	51	6 05 10 011 00 9	20.81



**Tool holder 1/4" external hexagon**  
1/4" Drive-Hex Socket  
with spring washer, magnetic

Ø mm	L mm	Part number	£ List Price excl. VAT
10,6	45	6 05 10 215 00 3	25.81

**18 V battery**



**Battery pack**  
Li-ion battery with charge status indicator and FEIN SafetyCell technology. Protects the battery and tool from overload, overheating and total discharge. Can be used with all FEIN 18 V cordless tools.

Current/Voltages V	Capacity Ah	Part number	£ List Price excl. VAT
18	5	9 26 04 173 02 0	111.38
18	2,5	9 26 04 171 02 0	76.34



**Battery starter set**  
2 x Li-ion batteries with ALG 50 rapid charger.

Current/Voltages V	Capacity Ah	Part number	£ List Price excl. VAT
18	5	9 26 04 301 03 0	268.29
18	2,5	9 26 04 301 04 0	197.14





Fastening

	ASCT 18 M Select	ASCT 18 Select	SCT 5-40 M	SCT 5-40 X	
	Powerful autofeed screwdriver for more than 2 300 repeated screw fittings per battery charge.	Very powerful cordless drywall screw gun with outstanding service life.	Autofeed screwdriver for quick repeated screw fittings with quiet clutch.	The specialist tool for drywall and interior work with quiet clutch.	
<b>EAN 4014586...</b>	... 887555	... 887562			
<b>Page</b>	40	40	40	40	
<b>Technical features</b>	Input			450 W	450 W
	Battery voltage	18 V	18 V		
	Battery compatibility	Li-ion/HighPower Li-ion	Li-ion/HighPower Li-ion		
	Battery interface	18 V	18 V		
	Speed, no load	0 - 4 000 1/min	0 - 4 000 1/min	0 - 4 000 1/min	0 - 4 000 1/min
	Max. torque (hard/soft)	14 / 7 Nm	14 / 7 Nm	12 / - Nm	12 / - Nm
	Screw Ø	4,2 mm	4,2 mm	5 mm	5 mm
	Rapid change chuck	1/4"	1/4"	1/4"	1/4"
	Weight according to EPTA			1,60 kg	1,30 kg
	Weight without storage battery	1,00 kg	1,50 kg		

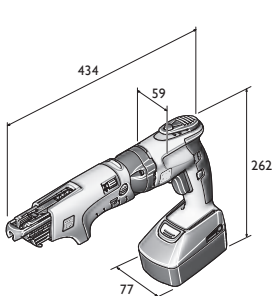

ASCT 18 M

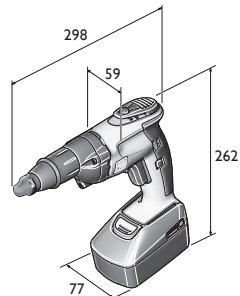

ASCT 18

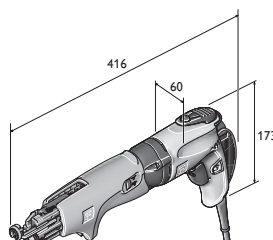

SCT 5-40 M

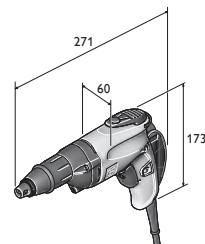

SCT 5-40 X

**FEIN SELECT<sup>+</sup>**



Type	Part number	EAN	PC	£ List Price excl. VAT
<b>ASCT 18 M Select</b>	<b>7 113 16 64 00 0</b>	<b>4014586887555</b>	<b>01</b>	<b>408.00</b>

**Price includes:**

1 Collated cartridge for collated screws, 1 long bit for magazine screw connections, 1 bit with dust protection ring, 1 bit holder, 1 depth stop, 1 hook, 1 belt clip, 1 plastic carrying case

For accessories, see page 41

**FEIN SELECT<sup>+</sup>**



Type	Part number	EAN	PC	£ List Price excl. VAT
<b>ASCT 18 Select</b>	<b>7 113 16 65 00 0</b>	<b>4014586887562</b>	<b>01</b>	<b>297.00</b>

**Price includes:**

1 bit with dust protection ring, 1 bit holder, 1 depth stop, 1 hook, 1 belt clip, 1 plastic carrying case

For accessories, see page 41



Type	Part number	PC	£ List Price excl. VAT
<b>SCT 5-40 M</b>	<b>7 213 06 50</b>	<b>01</b>	<b>399.00</b>

**Price includes:**

1 Collated cartridge for collated screws, 1 bit 1/4" size 2 / Phillips (form H), long, 1 depth stop, 1 magnetic holder for bits 1/4", 1 bit 1/4" for cross-slotted screws size 2 / Phillips (form H) with dust-protection ring, 1 hand strap, 1 belt clip, 1 plastic carrying case

For accessories, see page 41



Type	Part number	PC	£ List Price excl. VAT
<b>SCT 5-40 X</b>	<b>7 213 13</b>	<b>01</b>	<b>327.00</b>

**Price includes:**

1 hand strap, 1 belt clip, 1 depth stop, dust-proof protection, 1 magnetic holder for bits 1/4", 1 bit 1/4" for cross-slotted screws size 2 / Phillips (form H) with dust-protection ring

For accessories, see page 41

**General accessories**



**Cordless ALED 12-18 V LED lamp**  
Compact and durable cordless LED lamp with swivel-mounted lamp head. Compatible with all 12 / 14 / 18 V FEIN Li-ion batteries, including hook for attaching the lamp. Extremely lightweight at 130 g and very bright at 900 Lux. Colour temperature is the equivalent of daylight. The brightness can be set to 2 levels.

Part number	£ List Price excl. VAT
9 26 04 200 02 0	56.59



**Tool case**  
Plastic, inner dimensions: 470 x 275 x 116 mm

Part number	£ List Price excl. VAT
3 39 01 118 01 0	46.09



**Plastic box**  
Box insert with lockable lid for small parts and accessories, suitable for tool box 3 39 01 118 01 0, max 5 items/box.

Part number	£ List Price excl. VAT
3 39 01 119 00 0	4.54



**Quick charger ALG 50**  
For all FEIN Li-ion batteries. Charge time from 35 min.

Part number	£ List Price excl. VAT
9 26 04 129 01 0	45.53



**Quick charger ALG 30**  
For FEIN NiCd and Li-ion batteries. Charge time from 25 min.

Part number	£ List Price excl. VAT
9 26 04 096 01 0	163.10



**Tool holder 1/4" external hexagon**  
1/4" Drive-Hex Socket with quick-change chuck

Ø mm	L mm	Part number	£ List Price excl. VAT
15	51	6 05 10 011 00 9	20.81



**Bits 1/4" Hex socket**  
Form H/Phillips (pack of 5) extra hard, with dust protection ring

L mm	Size	Part number	£ List Price excl. VAT
25	2	6 27 12 109 03 4	9.12

**18 V battery**



**Battery pack**  
Li-ion battery with charge status indicator and FEIN SafetyCell technology. Protects the battery and tool from overload, overheating and total discharge. Can be used with all FEIN 18 V cordless tools.

Current/Voltages V	Capacity Ah	Part number	£ List Price excl. VAT
18	5	9 26 04 173 02 0	111.38
18	2,5	9 26 04 171 02 0	76.34



**Battery starter set**  
2 x Li-ion batteries with ALG 50 rapid charger.

Current/Voltages V	Capacity Ah	Part number	£ List Price excl. VAT
18	5	9 26 04 301 03 0	268.29
18	2,5	9 26 04 301 04 0	197.14

**Accessories for autofeed screwdrivers**



**M55 X magazine**  
for collated screws of 25 to 55 mm length and max. Ø 5 mm, tool-free changeover, weight 0.4 kg.

Part number	£ List Price excl. VAT
9 01 04 009 01 0	263.00

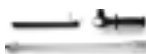

**M55 X magazine extension with belt guide**  
Length 520 mm

Part number	£ List Price excl. VAT
9 01 04 010 01 0	228.49



**Bits 1/4" Hex socket**  
for screwdriving into ceilings and floors  
Form H/Phillips, size 2

Part number	£ List Price excl. VAT
6 05 03 306 00 8	8.48



**High-speed construction screws**  
Fine-pitch screw for fastening drywall to metal substructures, countersunk head, Ø 8 mm

Ø mm	L mm	No. in pack pcs	Part number	£ List Price excl. VAT
3,9	35	1 000	6 39 01 030 01 4	51.45
3,9	35	10 000	6 39 01 030 02 0	298.58



**High-speed construction screws**  
Coarse-pitch screw for fastening drywall to wood substructures, countersunk head, Ø 8 mm

Ø mm	L mm	No. in pack pcs	Part number	£ List Price excl. VAT
3,9	30	1 000	6 39 01 031 01 3	51.45
3,9	30	10 000	6 39 01 031 02 0	298.58
3,9	35	1 000	6 39 01 032 01 6	51.45
3,9	35	10 000	6 39 01 032 02 0	298.58
3,9	45	1 000	6 39 01 033 01 0	67.03
3,9	45	10 000	6 39 01 033 02 0	388.64



**High-speed construction screws**  
Double threaded with milled rib for fastening Fermacell panels to metal or wood substructures.

Ø mm	L mm	No. in pack pcs	Part number	£ List Price excl. VAT
3,9	30	1 000	6 39 01 034 01 8	54.71
3,9	30	10 000	6 39 01 034 02 0	388.64



**High-speed construction screws**  
Double threaded with milled rib for wood substructures.

Ø mm	L mm	No. in pack pcs	Part number	£ List Price excl. VAT
4,2	35	1 000	6 39 01 035 01 2	63.75
4,2	35	10 000	6 39 01 035 02 0	376.86



# More than 100 years of working in continuous use: the FEIN grinding specialists.

Experience is everything, especially when like FEIN you are building resilient, user- focused, ergonomic and innovative grinding power tools for industry and manual trades. They come in various performance classes ranging from 350 to 3700 watts and for tough continuous use for example in foundries, steel or shipbuilding. From handy compact angle grinders to extremely powerful and large angle grinders and offering a wide range of straight grinders with a wide high frequency range, FEIN works hard to satisfy every need in the sanding department too.



---

## **Cordless angle grinder** **Page 44**

Dust-resistant and powerful tools for effective work in assembly jobs.



---

## **Compact angle grinders** **Page 46**

Three equipment lines, the same unbeatable quality - the right angle grinder for every job.



---

## **Angle Grinders** **Page 53**

Superior performance, comfortable and optimum safety FEIN angle grinders for heavy-duty grinding and cutting work.



---

## **Die Grinders** **Page 56**

The specialist tools for use in metal working, for grinding , brushing, deburring and polishing.



---

## **HF-angle grinder** **Page 62**

The specialists in continuous use when cutting and roughing-down under tough environmental conditions.



---

## **High Frequency Straight Grinders** **Page 66**

The specialists in continuous use when sanding and deburring under tough environmental conditions.



		CCG 18-115 BL	CCG 18-115 BL Select	CCG 18-125 BL	CCG 18-125 BL Select	CCG 18-115 BLPD	CCG 18-115 BLPD Select	CCG 18-125 BLPD	CCG 18-125 BLPD Select
		Dust-resistant and powerful, compact cordless angle grinder for effective cutting, grinding and deburring work in assembly jobs.				Dust-resistant and powerful, compact cordless angle grinder with dead man's switch for effective cutting, grinding and deburring work in assembly jobs.			
<b>EAN 4014586...</b>		... 888392	... 888408	... 888453	... 888460	... 888507	... 888514	... 888569	... 888576
<b>Page</b>		45	45	45	45	45	45	45	45
<b>Application</b>	roughing-down	▲	▲	▲	▲	▲	▲	▲	▲
	Deburring	▲▲	▲▲	▲▲	▲▲	▲▲	▲▲	▲▲	▲▲
	dividing	▲▲	▲▲	▲▲	▲▲	▲▲	▲▲	▲▲	▲▲
	brushing	▲	▲	▲	▲	▲	▲	▲	▲
	satın-finishing	▲▲	▲▲	▲▲	▲▲	▲▲	▲▲	▲▲	▲▲
	polishing	▲▲	▲▲	▲▲	▲▲	▲▲	▲▲	▲▲	▲▲
<b>Equipment</b>	POWERtronic tacho electronics	●	●	●	●	●	●	●	●
	Soft start	●	●	●	●	●	●	●	●
	Restart protection	●	●	●	●	●	●	●	●
	Brake	●	●	●	●	●	●	●	●
	Blockage monitoring	●	●	●	●	●	●	●	●
	Electronic overload protection	●	●	●	●	●	●	●	●
	Electronic speed preselection	●	●	●	●	●	●	●	●
AutoStop dead man's switch					●	●	●	●	
<b>Technical features</b>	Battery voltage	18 V	18 V	18 V	18 V	18 V	18 V	18 V	18 V
	Battery capacity	5,2 Ah		5,2 Ah		5,2 Ah		5,2 Ah	
	Battery compatibility	Li-ion/ HighPower Li-ion**	Li-ion/ HighPower Li-ion**	Li-ion/ HighPower Li-ion**	Li-ion/ HighPower Li-ion**	Li-ion/ HighPower Li-ion**	Li-ion/ HighPower Li-ion**	Li-ion/ HighPower Li-ion**	Li-ion/ HighPower Li-ion**
	Battery interface	MultiVolt	MultiVolt	MultiVolt	MultiVolt	MultiVolt	MultiVolt	MultiVolt	MultiVolt
	Grinding disc Ø	115 mm	115 mm	125 mm	125 mm	115 mm	115 mm	125 mm	125 mm
	Elast. Backing pad Ø	115 mm	115 mm	125 mm	125 mm	115 mm	115 mm	125 mm	125 mm
	Weight with battery	2,70 kg		2,70 kg		2,70 kg		2,70 kg	
	Weight without storage battery	1,95 kg	1,95 kg	1,95 kg	1,95 kg	1,95 kg	1,95 kg	1,95 kg	1,95 kg

▲ suitability    ▲▲ optimal suitability    ● included    \*\* Maximum performance with FEIN HighPower Li-ion battery



Available from April 2018

Type	Part number	EAN	PC	£ List Price excl. VAT
CCG 18-115 BL	7 120 01 61 24 0	4014586888392	01	633.00

**Price includes:**  
2 x battery packs (HighPower Li-ion), 1 rapid charger ALG 50, 1 wheel guard, 1 Tool-free quick-clamping nut, 1 anti-vibration handle, 1 key, 1 plastic carrying case  
For accessories, see page 51

FEIN SELECT<sup>+</sup>



Available from April 2018

Type	Part number	EAN	PC	£ List Price excl. VAT
CCG 18-115 BL Select	7 120 01 62 00 0	4014586888408	01	351.00

**Price includes:**  
1 wheel guard, 1 Tool-free quick-clamping nut, 1 anti-vibration handle, 1 key, 1 plastic carrying case  
For accessories, see page 51



Available from April 2018

Type	Part number	EAN	PC	£ List Price excl. VAT
CCG 18-125 BL	7 120 02 61 24 0	4014586888453	01	633.00

**Price includes:**  
2 x battery packs (HighPower Li-ion), 1 rapid charger ALG 50, 1 wheel guard, 1 Tool-free quick-clamping nut, 1 anti-vibration handle, 1 key, 1 plastic carrying case  
For accessories, see page 51

FEIN SELECT<sup>+</sup>



Available from April 2018

Type	Part number	EAN	PC	£ List Price excl. VAT
CCG 18-125 BL Select	7 120 02 62 00 0	4014586888460	01	351.00

**Price includes:**  
1 wheel guard, 1 Tool-free quick-clamping nut, 1 anti-vibration handle, 1 key, 1 plastic carrying case  
For accessories, see page 51



Available from April 2018

Type	Part number	EAN	PC	£ List Price excl. VAT
CCG 18-115 BLPD	7 120 03 61 24 0	4014586888507	01	633.00

**Price includes:**  
2 x battery packs (HighPower Li-ion), 1 rapid charger ALG 50, 1 wheel guard, 1 Tool-free quick-clamping nut, 1 anti-vibration handle, 1 key, 1 plastic carrying case  
For accessories, see page 51

FEIN SELECT<sup>+</sup>



Available from April 2018

Type	Part number	EAN	PC	£ List Price excl. VAT
CCG 18-115 BLPD Select	7 120 03 62 00 0	4014586888514	01	351.00

**Price includes:**  
1 wheel guard, 1 Tool-free quick-clamping nut, 1 anti-vibration handle, 1 key, 1 plastic carrying case  
For accessories, see page 51



Available from April 2018

Type	Part number	EAN	PC	£ List Price excl. VAT
CCG 18-125 BLPD	7 120 04 61 24 0	4014586888569	01	633.00

**Price includes:**  
2 x battery packs (HighPower Li-ion), 1 rapid charger ALG 50, 1 wheel guard, 1 Tool-free quick-clamping nut, 1 anti-vibration handle, 1 key, 1 plastic carrying case  
For accessories, see page 51

FEIN SELECT<sup>+</sup>



Available from April 2018

Type	Part number	EAN	PC	£ List Price excl. VAT
CCG 18-125 BLPD Select	7 120 04 62 00 0	4014586888576	01	351.00

**Price includes:**  
1 wheel guard, 1 Tool-free quick-clamping nut, 1 anti-vibration handle, 1 key, 1 plastic carrying case  
For accessories, see page 51



	MSfv 649-1	WSG 8-115	WSG 8-125	WSG 11-125	WSG 11-125 RT	WSG 12-125 P	WSG 15-125 PRT	WSG 17-125 P
	Long-necked angle grinder with spindle M 14 for working in difficult-to-reach areas.	Ergonomic 800 W compact angle grinder for deburring, sanding and cutting.		Ergonomic 1 100 W compact angle grinder for deburring, sanding and cutting.	Ergonomic 1 100 W compact angle grinder with FEIN ErgoGrip for fatigue-free working.	Ergonomic 1 200 W compact angle grinder with high power reserve for effective sanding and cutting.		Ergonomic compact angle grinder with high power reserve for effective sanding and cutting.
EAN 4014586...	... 858371							
Page	48	48	48	48	48	48	49	49
Application	roughing-down	▲▲	▲	▲	▲▲	▲▲		▲▲
	Deburring	▲	▲▲	▲▲	▲▲	▲▲		▲▲
	dividing		▲	▲	▲▲	▲▲		▲▲
	brushing		▲	▲	▲▲	▲		▲▲
	satin-finishing							
Equipment	polishing							
	POWERtronic tacho electronics						●	●
	Soft start						●	●
	Restart protection		●	●	●	●	●	●
	Blockage monitoring				●		●	●
	Electronic overload protection						●	●
	Electronic speed preselection							
	Long neck	●						
AutoStop dead man's switch	●				●		●	
Technical features	Input	750 W	800 W	800 W	1 200 W	1 100 W	1 200 W	1 500 W
	Speed, no load	12 000 1/min	11 000 1/min	11 000 1/min	11 000 1/min	11 000 1/min	11 000 1/min	11 000 1/min
	Weight according to EPTA	4,00 kg	2,00 kg	2,00 kg	2,10 kg	2,40 kg	2,10 kg	2,40 kg
	Flange	M 14	M 14	M 14	M 14	M 14	M 14	M 14
	Grinding disc Ø	125 mm	115 mm	125 mm	125 mm	125 mm	125 mm	125 mm
	Elast. Backing pad Ø		115 mm	125 mm	125 mm	125 mm	125 mm	125 mm

▲ suitability    ▲▲ optimal suitability    ● included

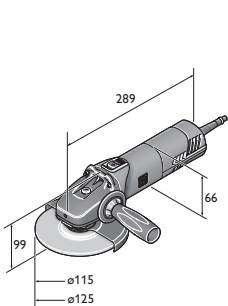

WSG 12-125 P  
WSG 12-125 PQ  
WSG 8-115  
WSG 8-125

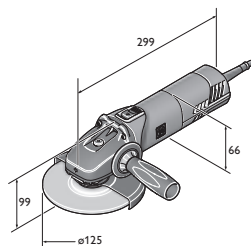

WSG 11-125  
WSG 12-125 P  
WSG 17-125 PQ

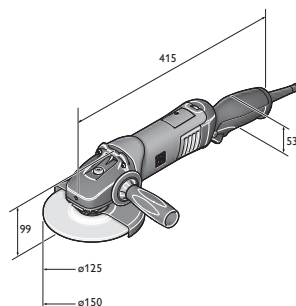

WSG 17-150 PR  
WSG 17-150 PRT  
WSG 17-70 Inox R  
WSG 17-70 Inox RT

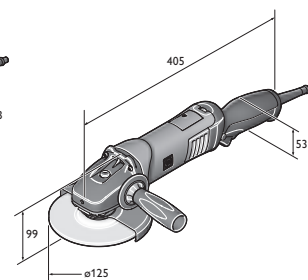

WSG 11-125 RT  
WSG 15-125 PRT  
WSG 17-125 PR  
WSG 17-125 PRT



	WSG 17-125 PS	WSG 17-150 P	WSG 17-70 Inox	WSG 17-125 PR	WSG 17-125 PRT	WSG 17-150 PR	WSG 17-150 PRT	WSG 17-70 Inox R	WSG 17-70 Inox RT
	The specialist tool for serrated and fibre discs with extra high torque.	Ergonomic compact angle grinder with high power reserve for effective sanding and cutting.	The specialist tool with variable speed for stainless steel processing.	Ergonomic compact angle grinder with FEIN ErgoGrip for fatigue-free working.				Ergonomic compact angle grinder with FEIN ErgoGrip for fatigue-free working in stainless steel applications.	
								... 883731	
	49	49	50	50	50	50	50	50	50
	▲▲	▲▲	▲▲	▲▲	▲▲	▲▲	▲▲	▲▲	▲▲
	▲	▲	▲	▲	▲	▲	▲	▲	▲
	▲	▲▲	▲	▲▲	▲▲	▲▲	▲▲	▲	▲
			▲▲					▲▲	▲▲
			▲					▲	▲
	●	●	●	●	●	●	●	●	●
	●	●	●	●	●	●	●	●	●
	●	●	●	●	●	●	●	●	●
	●	●	●	●	●	●	●	●	●
	●	●	●	●	●	●	●	●	●
			●					●	●
					●		●		●
	1 700 W	1 700 W	1 700 W	1 700 W	1 700 W	1 700 W	1 700 W	1 700 W	1 700 W
	8 500 1/min	8 500 1/min	2 700 - 8 500 1/min	11 000 1/min	11 000 1/min	8 500 1/min	8 500 1/min	2 700 - 8 500 1/min	2 700 - 8 500 1/min
	2,40 kg	2,40 kg	2,40 kg	2,40 kg	2,40 kg	2,60 kg	2,60 kg	2,50 kg	2,50 kg
	M 14	M 14	M 14	M 14	M 14	M 14	M 14	M 14	M 14
	125 mm	150 mm	125 mm	125 mm	150 mm	150 mm	150 mm	125 mm	125 mm
	125 mm	150 mm	125 mm	125 mm	150 mm	150 mm	150 mm	125 mm	125 mm

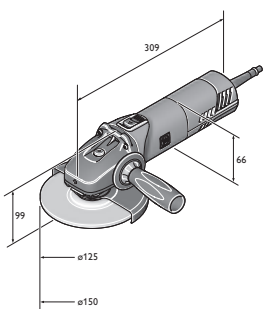

WSG 17-125 PS  
WSG 17-125 PSQ  
WSG 17-150 P  
WSG 17-150 PQ  
WSG 17-70 Inox



Type	Part number	EAN	PC	£ List Price excl. VAT
<b>MSfv 649-1*</b>	<b>7 221 31 00 23 0</b>	<b>4014586858371</b>	<b>01</b>	<b>899.00</b>

**Price includes:**  
1 wheel guard, 1 pair of flanges, 1 set of keys  
For accessories, see page 51  
\* 230 V only



Type	Part number	PC	£ List Price excl. VAT
<b>WSG 8-115</b>	<b>7 221 73 60</b>	<b>19</b>	<b>131.00</b>

**Price includes:**  
1 wheel guard, 1 pair of flanges, 1 additional handle, 1 key  
For accessories, see page 51



Type	Part number	PC	£ List Price excl. VAT
<b>WSG 8-125</b>	<b>7 221 74 60</b>	<b>19</b>	<b>129.00</b>

**Price includes:**  
1 wheel guard, 1 pair of flanges, 1 additional handle, 1 key  
For accessories, see page 51



Type	Part number	PC	£ List Price excl. VAT
<b>WSG 11-125</b>	<b>7 221 77 60</b>	<b>19</b>	<b>156.00</b>

**Price includes:**  
1 wheel guard, 1 pair of flanges, 1 additional handle, 1 key  
For accessories, see page 51



Type	Part number	PC	£ List Price excl. VAT
<b>WSG 11-125 RT</b>	<b>7 221 87 60</b>	<b>19</b>	<b>195.00</b>

**Price includes:**  
1 wheel guard, 1 pair of flanges, 1 additional handle, 1 key  
For accessories, see page 51



Type	Part number	PC	£ List Price excl. VAT
<b>WSG 12-125 P</b>	<b>7 221 75 60</b>	<b>19</b>	<b>194.00</b>

**Price includes:**  
1 wheel guard, 1 pair of flanges, 1 anti-vibration handle, 1 key  
For accessories, see page 51



Type	Part number	PC	£ List Price excl. VAT
<b>WSG 12-125 PQ</b>	<b>7 221 76 60</b>	<b>19</b>	<b>205.00</b>

**Price includes:**  
1 wheel guard, 1 Tool-free quick-clamping nut, 1 anti-vibration handle, 1 key  
For accessories, see page 51



Type	Part number	PC	£ List Price excl. VAT
<b>WSG 15-125 PRT</b>	<b>7 221 91 60</b>	<b>19</b>	<b>260.00</b>

**Price includes:**  
1 wheel guard, 1 pair of flanges, 1 anti-vibration handle, 1 key  
For accessories, see page 51



Type	Part number	PC	£ List Price excl. VAT
<b>WSG 17-125 P</b>	<b>7 222 07 60</b>	<b>19</b>	<b>235.00</b>

**Price includes:**  
1 wheel guard, 1 pair of flanges, 1 anti-vibration handle, 1 key  
For accessories, see page 51



Type	Part number	PC	£ List Price excl. VAT
<b>WSG 17-125 PQ</b>	<b>7 222 08 60</b>	<b>19</b>	<b>248.00</b>

**Price includes:**  
1 wheel guard, 1 Inner flange, 1 Tool-free quick-clamping nut, 1 anti-vibration handle, 1 key  
For accessories, see page 51



Type	Part number	PC	£ List Price excl. VAT
<b>WSG 17-125 PS</b>	<b>7 222 09 60</b>	<b>19</b>	<b>235.00</b>

**Price includes:**  
1 wheel guard, 1 pair of flanges, 1 anti-vibration handle, 1 key  
For accessories, see page 51



Type	Part number	PC	£ List Price excl. VAT
<b>WSG 17-125 PSQ</b>	<b>7 222 10 60</b>	<b>19</b>	<b>267.00</b>

**Price includes:**  
1 wheel guard, 1 Inner flange, 1 Tool-free quick-clamping nut, 1 anti-vibration handle, 1 key  
For accessories, see page 51



Type	Part number	PC	£ List Price excl. VAT
<b>WSG 17-150 P</b>	<b>7 222 11 60</b>	<b>19</b>	<b>235.00</b>

**Price includes:**  
1 wheel guard, 1 pair of flanges, 1 anti-vibration handle, 1 key  
For accessories, see page 51



Type	Part number	PC	£ List Price excl. VAT
<b>WSG 17-150 PQ</b>	<b>7 222 12 60</b>	<b>19</b>	<b>248.00</b>

**Price includes:**  
1 wheel guard, 1 Inner flange, 1 Tool-free quick-clamping nut, 1 anti-vibration handle, 1 key  
For accessories, see page 51



Type	Part number	PC	£ List Price excl. VAT
<b>WSG 17-70 Inox</b>	<b>7 222 13 60</b>	<b>19</b>	<b>337.00</b>

**Price includes:**  
1 wheel guard, 1 pair of flanges, 1 anti-vibration handle, 1 key  
For accessories, see page 51



Type	Part number	PC	£ List Price excl. VAT
<b>WSG 17-125 PR</b>	<b>7 222 18 60</b>	<b>19</b>	<b>273.00</b>

**Price includes:**  
1 wheel guard, 1 pair of flanges, 1 anti-vibration handle, 1 key  
For accessories, see page 51



Type	Part number	PC	£ List Price excl. VAT
<b>WSG 17-125 PRT</b>	<b>7 222 19 60</b>	<b>19</b>	<b>273.00</b>

**Price includes:**  
1 wheel guard, 1 pair of flanges, 1 anti-vibration handle, 1 key  
For accessories, see page 51



Type	Part number	PC	£ List Price excl. VAT
<b>WSG 17-150 PR</b>	<b>7 222 20 60</b>	<b>19</b>	<b>273.00</b>

**Price includes:**  
1 wheel guard, 1 pair of flanges, 1 anti-vibration handle, 1 key  
For accessories, see page 51



Type	Part number	PC	£ List Price excl. VAT
<b>WSG 17-150 PRT</b>	<b>7 222 21 60</b>	<b>19</b>	<b>POA</b>

**Price includes:**  
1 wheel guard, 1 pair of flanges, 1 anti-vibration handle, 1 key  
For accessories, see page 51



Type	Part number	EAN	PC	£ List Price excl. VAT
<b>WSG 17-70 Inox R</b>	<b>7 222 22 60 00 0</b>	<b>4014586883731</b>	<b>19</b>	<b>376.00</b>

**Price includes:**  
1 wheel guard, 1 pair of flanges, 1 anti-vibration handle, 1 key  
For accessories, see page 51



Type	Part number	PC	£ List Price excl. VAT
<b>WSG 17-70 Inox RT</b>	<b>7 222 23 60</b>	<b>19</b>	<b>POA</b>

**Price includes:**  
1 wheel guard, 1 pair of flanges, 1 anti-vibration handle, 1 key  
For accessories, see page 51



**General accessories**



**Tool case**  
Plastic, inner dimensions: 470 x 275 x 116 mm

Part number	£ List Price excl. VAT
3 39 01 118 01 0	46.09



**Plastic box**  
Box insert with lockable lid for small parts and accessories, suitable for tool box 3 39 01 118 01 0, max 5 items/box.

Part number	£ List Price excl. VAT
3 39 01 119 00 0	4.54



**anti-vibration handle**  
M 8, vibration absorbing, to reduce the vibrations during longer jobs.

Part number	£ List Price excl. VAT
3 21 19 124 01 0	9.75



**Quick-clamping nut**  
to change discs without need for tool, low height of just 8 mm

Part number	£ List Price excl. VAT
6 38 02 191 01 0	30.65



**Inner flange**

Part number	£ List Price excl. VAT
6 38 01 182 01 0	8.20



**Threaded flange**  
M 14, for flexible grinding/cutting discs, fan-pattern grinding wheels and round brush

Part number	£ List Price excl. VAT
6 38 02 052 00 0	8.20



**Threaded flange**  
M 14, for elastic backing pad and for twisted steel wire brush

Part number	£ List Price excl. VAT
6 38 01 154 00 7	7.65



**Elastic backing pad**  
with flange M 14, for fibre sanding sheets Ø 125 mm

Ø	Part number	£ List Price excl. VAT
mm		
125	6 38 06 087 01 3	6.40



**Work gloves**  
Vibration-attenuating, certified according to EN 388/420, EN ISO 10819, EEC No. 0200, No. in pack 1 pair

Size	Part number	£ List Price excl. VAT
9 L	3 21 73 003 00 3	100.18
10 XL	3 21 73 004 00 1	100.18
11 XXL	3 21 73 005 00 5	100.18



**Cordless ALED 12-18 V LED lamp**  
Compact and durable cordless LED lamp with swivel-mounted lamp head. Compatible with all 12 / 14 / 18 V FEIN Li-ion batteries, including hook for attaching the lamp. Extremely lightweight at 130 g and very bright at 900 Lux. Colour temperature is the equivalent of daylight. The brightness can be set to 2 levels.

Part number	£ List Price excl. VAT
9 26 04 200 02 0	56.59



**Quick charger ALG 50**  
For all FEIN Li-ion batteries. Charge time from 35 min.

Part number	£ List Price excl. VAT
9 26 04 129 01 0	45.53



**Quick charger ALG 30**  
For FEIN NiCd and Li-ion batteries. Charge time from 25 min.

Part number	£ List Price excl. VAT
9 26 04 096 01 0	163.10

**18 V battery**



**HighPower battery pack**  
HighPower Li-ion battery with cells capable of handling high currents, charge status indicator and FEIN SafetyCell technology. Continually high power output with 75% higher current rating than a Li-ion battery. Recommended for FEIN cordless magnetic core drills and cordless angle grinders. Can be used with all FEIN 18 V cordless tools.

Current/Voltages V	Capacity Ah	Part number	£ List Price excl. VAT
18	5,2	9 26 04 179 02 0	117.78



**FEIN Select+ HighPower battery starter set**  
2 x HighPower Li-ion batteries with ALG 50 rapid charger.

Current/Voltages V	Capacity Ah	Part number	£ List Price excl. VAT
18	5,2	9 26 04 307 01 0	281.40

**Protective covers**



**Wheel guard**  
for serrated and roughing discs

Ø mm	Part number	£ List Price excl. VAT
115	3 18 10 299 00 0	10.37
125	3 18 10 300 00 0	10.51
150	3 18 10 301 00 0	10.82



**Safety hood for cutting work**  
for safe working with cutting wheels

Ø mm	Part number	£ List Price excl. VAT
115	6 38 11 016 01 0	31.31
125	6 38 11 017 01 0	31.31
150	6 38 11 018 01 0	31.31

**Accessories for MSfv 649-1**



**Tool case**  
metal 700 x 180 x 100 mm

Part number	£ List Price excl. VAT
3 39 01 021 01 1	59.59

**Inner flange**  
for wheels Ø 125 mm

Part number	£ List Price excl. VAT
6 38 01 079 00 9	8.06

**Threaded flange**  
M 14, for wheels up to 6 mm

Part number	£ List Price excl. VAT
6 38 02 084 00 9	8.06



	WSB 20-180	WSB 20-230	WSG 20-180	WSG 20-230	WSB 25-180 X	WSB 25-230 X	WSG 25-180	WSG 25-230
	Powerful safety angle grinder for grinding work.	Powerful safety angle grinder for grinding and cutting work.	Powerful angle grinder for grinding work.	Powerful angle grinder for grinding and cutting work.	The most powerful FEIN safety angle grinder for extreme grinding work.	The most powerful FEIN safety angle grinder for extreme cutting and grinding work.	The most powerful FEIN angle grinder for extreme grinding work.	The most powerful FEIN angle grinder for extreme cutting and grinding work.
<b>EAN 4014586...</b>	... 851242	... 851259			... 853116	... 853123		
<b>Page</b>	54	54	54	54	54	54	54	54
<b>Application</b>	Deburring	▲		▲	▲	▲	▲	▲
	roughing-down	▲▲		▲▲	▲▲	▲	▲▲	▲
	brushing						▲	
	dividing			▲	▲		▲▲	▲▲
<b>Equipment</b>	FEIN high-power motor	●	●	●	●	●	●	●
	Soft start	●	●	●	●	●	●	●
	Restart protection	●	●	●	●	●	●	●
	Brake	●	●			●	●	
	AutoStop dead man's switch	+	+	+	+	+	+	+
<b>Technical features</b>	Input	2 000 W	2 000 W	2 000 W	2 000 W	2 500 W	2 500 W	2 500 W
	Speed, no load	8 500 1/min	6 600 1/min	8 500 1/min	6 600 1/min	8 500 1/min	6 600 1/min	8 500 1/min
	Weight according to EPTA	5,90 kg	5,90 kg	5,60 kg	5,60 kg	6,50 kg	6,70 kg	6,30 kg
	Tool Holder	QuickIN	QuickIN			QuickIN	QuickIN	
	Mounting hole Ø	22,23 mm	22,23 mm			22,23 mm	22,23 mm	
	Flange			M 14	M 14			M 14
	Grinding disc Ø	180 mm	230 mm	180 mm	230 mm	180 mm	230 mm	230 mm
	Elast. Backing pad Ø	180 mm	230 mm	180 mm	230 mm	180 mm	230 mm	230 mm

▲ suitability    ▲▲ optimal suitability    + optional    ● included

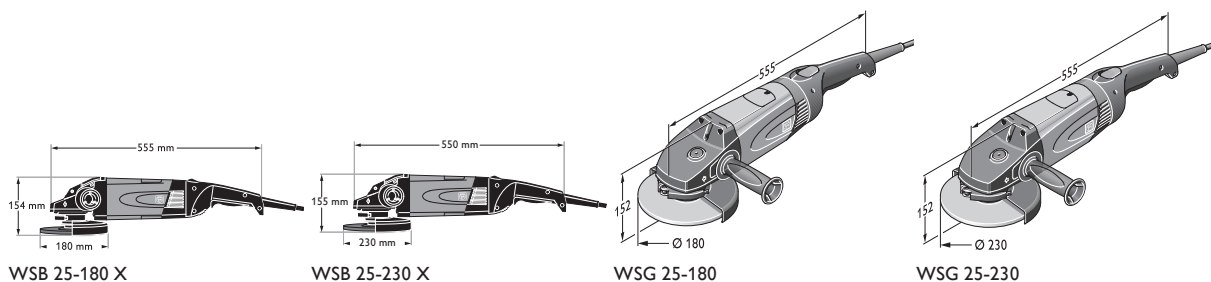



Type	Part number	EAN	PC	£ List Price excl. VAT
<b>WSB 20-180*</b>	<b>7 221 05 00 23 7</b>	<b>4014586851242</b>	<b>01</b>	<b>445.00</b>

**Price includes:**  
1 wheel guard, 1 clamp for flexible grinding/cutting discs, 1 additional handle  
You will find tools with the AutoStop dead man's switch in the numerical section.  
For accessories, see page 55  
\* 230 V only



Type	Part number	EAN	PC	£ List Price excl. VAT
<b>WSB 20-230*</b>	<b>7 221 06 00 23 0</b>	<b>4014586851259</b>	<b>01</b>	<b>445.00</b>

**Price includes:**  
1 wheel guard, 1 clamp for flexible grinding/cutting discs, 1 additional handle  
You will find tools with the AutoStop dead man's switch in the numerical section.  
For accessories, see page 55  
\* 230 V only



Type	Part number	PC	£ List Price excl. VAT
<b>WSG 20-180</b>	<b>7 221 07</b>	<b>01</b>	<b>383.00</b>

**Price includes:**  
1 wheel guard, 1 pair of flanges, 1 additional handle, 1 key  
You will find tools with the AutoStop dead man's switch in the numerical section.  
For accessories, see page 55



Type	Part number	PC	£ List Price excl. VAT
<b>WSG 20-230</b>	<b>7 221 08 24</b>	<b>01</b>	<b>383.00</b>

**Price includes:**  
1 wheel guard, 1 pair of flanges, 1 additional handle, 1 key  
You will find tools with the AutoStop dead man's switch in the numerical section.  
For accessories, see page 55



Type	Part number	EAN	PC	£ List Price excl. VAT
<b>WSB 25-180 X*</b>	<b>7 221 10 00 23 3</b>	<b>4014586853116</b>	<b>01</b>	<b>549.00</b>

**Price includes:**  
1 wheel guard, 1 clamp for flexible grinding/cutting discs, 1 additional handle  
You will find tools with the AutoStop dead man's switch in the numerical section.  
For accessories, see page 55  
\* 230 V only



Type	Part number	EAN	PC	£ List Price excl. VAT
<b>WSB 25-230 X*</b>	<b>7 221 11 00 23 2</b>	<b>4014586853123</b>	<b>01</b>	<b>549.00</b>

**Price includes:**  
1 wheel guard, 1 clamp for flexible grinding/cutting discs, 1 additional handle  
You will find tools with the AutoStop dead man's switch in the numerical section.  
For accessories, see page 55  
\* 230 V only



Type	Part number	PC	£ List Price excl. VAT
<b>WSG 25-180</b>	<b>7 221 26</b>	<b>01</b>	<b>491.00</b>

**Price includes:**  
1 wheel guard, 1 pair of flanges, 1 additional handle, 1 key  
You will find tools with the AutoStop dead man's switch in the numerical section.  
For accessories, see page 55



Type	Part number	PC	£ List Price excl. VAT
<b>WSG 25-230</b>	<b>7 221 27</b>	<b>01</b>	<b>471.00</b>

**Price includes:**  
1 key, 1 wheel guard, 1 pair of flanges, 1 additional handle  
You will find tools with the AutoStop dead man's switch in the numerical section.  
For accessories, see page 55





**General accessories**



**Tool case**  
Metal

Width mm	Length mm	Height mm	Part number	£ List Price excl. VAT
240	690	160	3 39 01 022 01 4	54.75



**anti-vibration handle**  
M 14, vibration absorbing, to reduce the vibrations during longer jobs.

Part number	£ List Price excl. VAT
3 21 19 117 01 5	39.08



**Work gloves**  
Vibration-attenuating, certified according to EN 388/420, EN ISO 10819, EEC No. 0200, No. in pack 1 pair

Size	Part number	£ List Price excl. VAT
9 L	3 21 73 003 00 3	100.18
10 XL	3 21 73 004 00 1	100.18
11 XXL	3 21 73 005 00 5	100.18



**Connecting piece**  
Universal device to connect power tools and accessories with dust extraction to vacuum cleaner. Flexible rubber sleeve, length 70 mm, inner diameter 31.5 mm.

Part number	£ List Price excl. VAT
3 13 22 771 00 9	5.59

**Protective covers**



**Safety hood for cutting work**

Ø mm	Part number	£ List Price excl. VAT
180	6 38 11 004 01 0	34.16
230	6 38 11 005 01 0	35.26



**Protective suction hood**  
with guide block for cutting discs Ø 180 mm cutting depth 40 mm, connection Ø 32 mm

Part number	£ List Price excl. VAT
9 06 04 008 01 3	256.40



**Protective suction hood**  
with guide block for cutting discs Ø 230 mm cutting depth 65 mm, connection Ø 32 mm

Part number	£ List Price excl. VAT
9 06 04 009 01 7	269.34

**Accessories for WSB**



**Clamping unit**  
for flexible grinding/cutting discs as well as for fan-pattern wheels

Part number	£ List Price excl. VAT
6 38 02 183 02 5	40.76



**Elastic backing pad**  
with clamping unit

Ø mm	Part number	£ List Price excl. VAT
180	6 38 06 174 02 8	52.60



**Elastic backing pad**  
without clamping unit

Ø mm	Part number	£ List Price excl. VAT
180	6 38 06 174 01 2	18.38



**Clamping unit**  
for elastic backing pads

Part number	£ List Price excl. VAT
6 38 02 185 02 7	40.76

**Accessories for WSG**



**Threaded flange**  
M 14, for flexible grinding/cutting discs, fan-pattern grinding wheels and round brush

Part number	£ List Price excl. VAT
6 38 02 052 00 0	8.20



**Inner flange**

Part number	£ List Price excl. VAT
6 38 01 182 01 0	8.20



**Elastic backing pad**  
with flange M 14

Ø mm	Part number	£ List Price excl. VAT
180	6 38 06 034 01 7	13.07



**Threaded flange**  
M 14, for elastic backing pad and for twisted steel wire brush

Part number	£ List Price excl. VAT
6 38 01 154 00 7	7.65



	AGSZ 18-280 BL	AGSZ 18-280 BL Select	AGSZ 18-280 LBL	AGSZ 18-280 LBL Select	AGSZ 18-90 LBL	AGSZ 18-90 LBL Select	GSZ 4-280 EL	GSZ 4-90 EL	
	Dust-resistant and powerful, compact cordless die grinder for effective cutting, grinding, deburring and milling work.		Dust-resistant and powerful, compact cordless die grinder with large plunge depth for effective cutting, grinding, deburring and milling work.		Dust-resistant and powerful, compact cordless die grinder with large plunge depth for grinding and polishing work.		Extremely ergonomic die grinder with high plunge depth for light grinding and deburring in especially difficult-to-reach spots.	Extremely ergonomic die grinder for stainless steel processing with high plunge depth for light grinding and polishing in especially difficult-to-reach spots.	
<b>EAN 4014586...</b>	... 888620	... 888637	... 888682	... 888699	... 888743	... 888750			
<b>Page</b>	58	58	58	58	58	58	59	59	
<b>Application</b>	satin-finishing				▲▲	▲▲		▲▲	
	brushing	▲	▲			▲▲	▲	▲▲	
	polishing					▲▲		▲▲	
	cutting	▲▲	▲▲	▲▲	▲▲			▲▲	
	Grinding	▲▲	▲▲	▲▲	▲▲	▲▲	▲▲	▲▲	
	roughing-down	▲▲	▲▲	▲▲	▲▲			▲▲	
	Deburring dividing	▲	▲	▲	▲			▲	
<b>Technical features</b>	Input						350 W	350 W	
	Battery voltage	18 V	18 V	18 V	18 V	18 V			
	Battery capacity	5 Ah		5 Ah		5 Ah			
	Battery compatibility	Li-ion/ HighPower Li-ion	Li-ion/ HighPower Li-ion	Li-ion/ HighPower Li-ion	Li-ion/ HighPower Li-ion	Li-ion/ HighPower Li-ion	Li-ion/ HighPower Li-ion		
	Battery interface	MultiVolt	MultiVolt	MultiVolt	MultiVolt	MultiVolt	MultiVolt		
	Speed, no load	9 000 - 28 000 1/min	9 000 - 28 000 1/min	9 000 - 28 000 1/min	9 000 - 28 000 1/min	2 900 - 9 000 1/min	2 900 - 9 000 1/min	13 000 - 28 000 1/min	3 500 - 8 500 1/min
	Collet for max. Ø	8 mm	8 mm	8 mm	8 mm	8 mm	8 mm	6 mm	6 mm
	Grinding wheel for max. Ø	50 mm	50 mm	50 mm	50 mm	50 mm	50 mm	20 mm	20 mm
	Weight according to EPTA							1,50 kg	1,50 kg
	Weight with battery	2,10 kg		2,30 kg		2,50 kg			
Weight without storage battery	1,40 kg	1,40 kg	1,60 kg	1,60 kg	1,80 kg	1,80 kg			
Long neck							●	●	

▲ suitability    ▲▲ optimal suitability    ● included

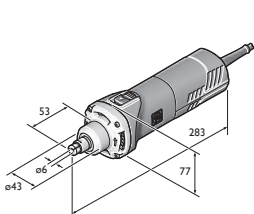

GSZ 8-280 P  
GSZ 8-280 PE  
GSZ 8-280 PEL

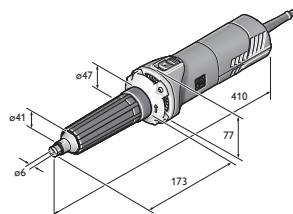

GSZ 8-280 PL

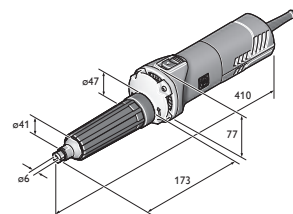

GSZ 8-90 PEL

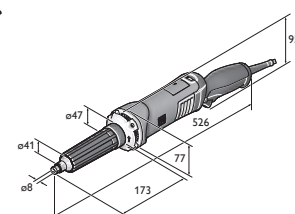

GSZ 11-320 PERL  
GSZ 11-320 PRL

	GSZ 8-280 P	GSZ 8-280 PE	GSZ 8-280 PL	GSZ 8-280 PEL	GSZ 8-90 PEL	GSZ 11-320 PRL	GSZ 11-320 PERL	GSZ 11-90 PERL
	Ergonomic, powerful die grinder for grinding and deburring in difficult-to-reach spots; also suitable for semi-stationary use.		Ergonomic, powerful die grinder with high plunge depth for grinding and deburring in difficult-to-reach spots.		Ergonomic, powerful die grinder for stainless steel processing with high plunge depth for grinding and polishing in especially difficult-to-reach spots.	Ergonomic, extremely powerful die grinder with high plunge depth for heavy-duty grinding and deburring in difficult-to-reach spots.		Ergonomic, extremely powerful die grinder for stainless steel processing with high plunge depth for heavy-duty grinding and polishing.
	59	59	59	59	60	60	60	60
		▲		▲	▲▲	▲	▲	▲▲
					▲▲			▲▲
	▲▲	▲▲	▲▲	▲▲	▲▲	▲▲	▲▲	▲▲
	▲▲	▲▲	▲▲	▲▲	▲▲	▲▲	▲▲	▲▲
		▲	▲	▲		▲	▲	
	750 W	750 W	750 W	750 W	710 W	1 010 W	1 010 W	1 010 W
	28 000 1/min	8 500 - 28 000 1/min	28 000 1/min	8 500 - 28 000 1/min	2 500 - 9 000 1/min	32 500 1/min	9 500 - 32 500 1/min	2 900 - 9 900 1/min
	8 mm	8 mm	8 mm	8 mm	8 mm	8 mm	8 mm	8 mm
	45 mm	50 mm		50 mm	50 mm	45 mm	45 mm	50 mm
	1,40 kg	1,40 kg	1,80 kg	1,80 kg	1,80 kg	2,10 kg	2,10 kg	2,20 kg
			●	●	●	●	●	●

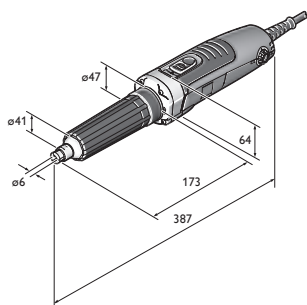

GSZ 4-280 EL



Available from April 2018

Type	Part number	EAN	PC	£ List Price excl. VAT
<b>AGSZ 18-280 BL</b>	<b>7 123 01 61 24 0</b>	<b>4014586888620</b>	<b>01</b>	<b>556.00</b>

**Price includes:**

2 battery packs (Li-ion), 1 rapid charger ALG 50, 1 collet Ø 6 mm, Jaw spanner SW13, Jaw spanner SW17, 1 plastic carrying case

For accessories, see page 61

**FEIN SELECT<sup>+</sup>**



Available from April 2018

Type	Part number	EAN	PC	£ List Price excl. VAT
<b>AGSZ 18-280 BL Select</b>	<b>7 123 01 62 00 0</b>	<b>4014586888637</b>	<b>01</b>	<b>277.00</b>

**Price includes:**

1 collet Ø 6 mm, Jaw spanner SW13, Jaw spanner SW17, 1 plastic carrying case

For accessories, see page 61



Available from April 2018

Type	Part number	EAN	PC	£ List Price excl. VAT
<b>AGSZ 18-280 LBL</b>	<b>7 123 02 61 24 0</b>	<b>4014586888682</b>	<b>01</b>	<b>580.00</b>

**Price includes:**

2 battery packs (Li-ion), 1 rapid charger ALG 50, 1 collet Ø 6 mm, Jaw spanner SW13, Jaw spanner SW17, 1 plastic carrying case

For accessories, see page 61

**FEIN SELECT<sup>+</sup>**



Available from April 2018

Type	Part number	EAN	PC	£ List Price excl. VAT
<b>AGSZ 18-280 LBL Select</b>	<b>7 123 02 62 00 0</b>	<b>4014586888699</b>	<b>01</b>	<b>300.00</b>

**Price includes:**

1 collet Ø 6 mm, Jaw spanner SW13, Jaw spanner SW17, 1 plastic carrying case

For accessories, see page 61



Available from April 2018

Type	Part number	EAN	PC	£ List Price excl. VAT
<b>AGSZ 18-90 LBL</b>	<b>7 123 03 61 24 0</b>	<b>4014586888743</b>	<b>01</b>	<b>603.00</b>

**Price includes:**

2 battery packs (Li-ion), 1 rapid charger ALG 50, 1 collet Ø 6 mm, Jaw spanner SW13, Jaw spanner SW17, 1 plastic carrying case

For accessories, see page 61

**FEIN SELECT<sup>+</sup>**



Available from April 2018

Type	Part number	EAN	PC	£ List Price excl. VAT
<b>AGSZ 18-90 LBL Select</b>	<b>7 123 03 62 00 0</b>	<b>4014586888750</b>	<b>01</b>	<b>323.00</b>

**Price includes:**

1 collet Ø 6 mm, Jaw spanner SW13, Jaw spanner SW17, 1 plastic carrying case

For accessories, see page 61



Type	Part number	PC	£ List Price excl. VAT
<b>GSZ 4-280 EL*</b>	<b>7 223 24 60</b>	<b>01</b>	<b>470.00</b>

**Price includes:**  
1 collet Ø 6 mm, Jaw spanner SW13, Jaw spanner SW17  
For accessories, see page 61  
\* 230 V only



Type	Part number	PC	£ List Price excl. VAT
<b>GSZ 4-90 EL*</b>	<b>7 223 25 60</b>	<b>01</b>	<b>470.00</b>

**Price includes:**  
Jaw spanner SW17, 1 collet Ø 6 mm, Jaw spanner SW13  
For accessories, see page 61  
\* 230 V only



Type	Part number	PC	£ List Price excl. VAT
<b>GSZ 8-280 P</b>	<b>7 223 16 60</b>	<b>01</b>	<b>267.00</b>

**Price includes:**  
1 collet Ø 6 mm, Jaw spanner SW13, Jaw spanner SW17  
For accessories, see page 61



Type	Part number	PC	£ List Price excl. VAT
<b>GSZ 8-280 PE</b>	<b>7 223 17 60</b>	<b>01</b>	<b>295.00</b>

**Price includes:**  
1 collet Ø 6 mm, Jaw spanner SW13, Jaw spanner SW17  
For accessories, see page 61



Type	Part number	PC	£ List Price excl. VAT
<b>GSZ 8-280 PL</b>	<b>7 223 18 60</b>	<b>01</b>	<b>481.00</b>

**Price includes:**  
Jaw spanner SW13, 1 collet Ø 6 mm, Jaw spanner SW17  
For accessories, see page 61



Type	Part number	PC	£ List Price excl. VAT
<b>GSZ 8-280 PEL</b>	<b>7 223 19 60</b>	<b>01</b>	<b>508.00</b>

**Price includes:**  
1 collet Ø 6 mm, Jaw spanner SW13, Jaw spanner SW17  
For accessories, see page 61



Type	Part number	PC	£ List Price excl. VAT
<b>GSZ 8-90 PEL</b>	<b>7 223 20 60</b>	<b>01</b>	<b>602.00</b>

**Price includes:**  
1 collet Ø 6 mm, Jaw spanner SW13, Jaw spanner SW17  
For accessories, see page 61



Type	Part number	PC	£ List Price excl. VAT
<b>GSZ 11-320 PRL</b>	<b>7 223 21 60</b>	<b>01</b>	<b>529.00</b>

**Price includes:**  
1 collet Ø 8 mm, Jaw spanner SW13, Jaw spanner SW17  
For accessories, see page 61



Type	Part number	PC	£ List Price excl. VAT
<b>GSZ 11-320 PERL</b>	<b>7 223 22 60</b>	<b>01</b>	<b>548.00</b>

**Price includes:**  
1 collet Ø 8 mm, Jaw spanner SW13, Jaw spanner SW17  
For accessories, see page 61



Type	Part number	PC	£ List Price excl. VAT
<b>GSZ 11-90 PERL</b>	<b>7 223 23 60</b>	<b>01</b>	<b>642.00</b>

**Price includes:**  
1 collet Ø 8 mm, Jaw spanner SW13, Jaw spanner SW17  
For accessories, see page 61



**General accessories**



**Tool case**  
Plastic, inner dimensions: 470 x 275 x 116 mm

Part number	£ List Price excl. VAT
3 39 01 118 01 0	46.09



**Plastic box**  
Box insert with lockable lid for small parts and accessories, suitable for tool box 3 39 01 118 01 0, max 5 items/box.

Part number	£ List Price excl. VAT
3 39 01 119 00 0	4.54



**Cordless ALED 12-18 V LED lamp**  
Compact and durable cordless LED lamp with swivel-mounted lamp head. Compatible with all 12 / 14 / 18 V FEIN Li-ion batteries, including hook for attaching the lamp. Extremely lightweight at 130 g and very bright at 900 Lux. Colour temperature is the equivalent of daylight. The brightness can be set to 2 levels.

Part number	£ List Price excl. VAT
9 26 04 200 02 0	56.59



**Quick charger ALG 50**  
For all FEIN Li-ion batteries. Charge time from 35 min.

Part number	£ List Price excl. VAT
9 26 04 129 01 0	45.53



**Quick charger ALG 30**  
For FEIN NiCd and Li-ion batteries. Charge time from 25 min.

Part number	£ List Price excl. VAT
9 26 04 096 01 0	163.10

**18 V battery**



**Battery pack**  
Li-ion battery with charge status indicator and FEIN SafetyCell technology. Protects the battery and tool from overload, overheating and total discharge. Can be used with all FEIN 18 V cordless tools.

Current/Voltages V	Capacity Ah	Part number	£ List Price excl. VAT
18	5	9 26 04 173 02 0	111.38
18	2,5	9 26 04 171 02 0	76.34



**Battery starter set**  
2 x Li-ion batteries with ALG 50 rapid charger.

Current/Voltages V	Capacity Ah	Part number	£ List Price excl. VAT
18	5	9 26 04 301 03 0	268.29
18	2,5	9 26 04 301 04 0	197.14

**Collets for GSZ 4, GSZ 8, GSZ 11**



**Collets**  
With all-round flange to protect the workpiece and prevent the wrench sliding off during tool changes.

Ø	Part number	£ List Price excl. VAT
3 mm	6 32 07 130 00 0	23.34
6 mm	6 32 07 128 00 0	21.96
8 mm	6 32 07 129 00 0	21.96
1/4"	6 32 07 131 00 0	21.96



**Collets Inox**  
Stainless steel model, with all-round flange to protect the workpiece and prevent the wrench sliding off during tool changes.

Ø	Part number	£ List Price excl. VAT
3 mm	6 32 07 132 00 0	27.01
6 mm	6 32 07 133 00 0	25.42
8 mm	6 32 07 134 00 0	27.01
1/4"	6 32 07 135 00 0	27.01

**Collets for MSh 635**



**Collets**

Ø	Part number	£ List Price excl. VAT
3 mm	6 32 07 097 00 0	25.56
6 mm	6 32 07 103 00 9	26.03

**Collets for MSh 636-1, MSh 648-1, MSHe 648-1, MShy 648-1Z**



**Collets**  
Depth 30 mm

Ø	Part number	£ List Price excl. VAT
3 mm	6 32 07 087 00 1	26.03
6 mm	6 32 07 059 00 6	26.03
8 mm	6 32 07 069 00 5	26.03
1/4"	6 32 07 088 00 9	26.03



	MSfo 869-1c 300 Hz 200 V	MSfo 869-1d 300 Hz 200 V	MSfo 852-1c 300 Hz 200 V	MSfo 852-1d 300 Hz 200 V	MSfo 870-1c 300 Hz 200 V
	Powerful HF angle grinder for heavy-duty cutting and grinding work.	Powerful HF angle grinder for heavy-duty grinding work.	Powerful HF angle grinder for medium- to heavy-duty grinding and brushing work.		The most powerful FEIN HF angle grinder for extreme cutting and grinding work.
<b>EAN 4014586...</b>	... 856759	... 856834	... 856933	... 856971	... 857053
<b>Page</b>	64	64	64	64	64
<b>Appli- cation</b>	roughing-down	▲▲	▲▲	▲▲	▲▲
	Deburring	▲	▲	▲	▲
	dividing	▲▲	▲	▲	▲▲
<b>Technical features</b>	Frequency	300 Hz	300 Hz	300 Hz	300 Hz
	Voltage/type of current	200 V/3~	200 V/3~	200 V/3~	200 V/3~
	Input	3 100 W	3 100 W	1 900 W	1 900 W
	Output	2 450 W	2 450 W	1 400 W	1 400 W
	Speed, no load	6 500 1/min	8 600 1/min	6 400 1/min	8 500 1/min
	Cable	5 m	5 m	5 m	5 m
	Weight according to EPTA	7,70 kg	7,40 kg	6,30 kg	5,90 kg
	Flange	M 14	M 14	M 14	M 14
	Grinding disc Ø	230 mm	180 mm	230 mm	180 mm
Elast. Backing pad Ø	180 mm	180 mm	180 mm	180 mm	

▲ suitability    ▲▲ optimal suitability



MSfo 869-1c  
MSfo 869-1d



MSfo 852-1c  
MSfo 852-1d



MSfo 870-1c



MSfo 870-1d



	<b>MSfo 870-1d</b> 300 Hz 200 V	<b>MSfo 849-1c</b> 300 Hz 200 V	<b>MSfov 852-1</b> 300 Hz 200 V	<b>MSf 843-1c</b> 300 Hz 200 V	<b>HFW 9-125</b> 300 Hz 200 V	<b>MSfov 852-1-180</b> 300 Hz 200 V
	The most powerful FEIN HF angle grinder for extreme grinding work.	Powerful HF angle grinder for medium-duty grinding work.	Long-neck HF angle grinder for hard-to-reach places.	Powerful HF compact angle grinder for medium-duty grinding and deburring work.	Handy HF compact angle grinder for light-duty grinding and deburring work.	Long-neck HF angle grinder for hard-to-reach places.
	... 857107	... 857145	... 857336	... 864402	... 869513	... 886022
	64	64	65	65	65	65
	▲▲		▲▲	▲▲		▲▲
	▲		▲	▲		▲
	▲			▲		
	300 Hz	300 Hz	300 Hz	300 Hz	300 Hz	300 Hz
	200 V/3~	200 V/3~	200 V/3~	200 V/3~	200 V/3~	200 V/3~
	3 700 W	1 500 W	1 900 W	1 100 W	900 W	1 900 W
	2 800 W	1 075 W	1 400 W	700 W	690 W	1 400 W
	8 600 1/min	6 150 1/min	8 800 1/min	6 500 1/min	7 100 1/min	7 450 1/min
	5 m	5 m	5 m	5 m	5 m	5 m
	8,20 kg	5,10 kg	5,20 kg	3,60 kg	2,50 kg	5,30 kg
	M 14	M 14	M 14	M 14		M 14
	180 mm	180 mm	125 mm	125 mm	125 mm	180 mm
	180 mm	180 mm		125 mm	125 mm	



MSfov 852-1

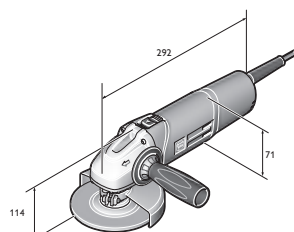

HFW 9-125



Type	Part number	EAN	PC	£ List Price excl. VAT
<b>MSfo 869-1c 300 Hz 200 V</b>	<b>7 820 62 00 26 0</b>	<b>4014586856759</b>	<b>09</b>	<b>1,349.00</b>

**Price includes:**

1 wheel guard, 1 pair of flanges, 1 set of keys, 1 anti-vibration handle

You will find other frequencies and voltages in the numerical section.

For accessories, see page 68



Type	Part number	EAN	PC	£ List Price excl. VAT
<b>MSfo 869-1d 300 Hz 200 V</b>	<b>7 820 65 00 26 0</b>	<b>4014586856834</b>	<b>09</b>	<b>1,349.00</b>

**Price includes:**

1 wheel guard, 1 pair of flanges, 1 set of keys, 1 anti-vibration handle

You will find other frequencies and voltages in the numerical section.

For accessories, see page 68



Type	Part number	EAN	PC	£ List Price excl. VAT
<b>MSfo 852-1c 300 Hz 200 V</b>	<b>7 820 71 00 26 0</b>	<b>4014586856933</b>	<b>09</b>	<b>1,186.00</b>

**Price includes:**

1 wheel guard, 1 pair of flanges, 1 set of keys, 1 anti-vibration handle

You will find other frequencies and voltages in the numerical section.

For accessories, see page 68



Type	Part number	EAN	PC	£ List Price excl. VAT
<b>MSfo 852-1d 300 Hz 200 V</b>	<b>7 820 73 00 26 0</b>	<b>4014586856971</b>	<b>09</b>	<b>1,175.00</b>

**Price includes:**

1 wheel guard, 1 pair of flanges, 1 set of keys, 1 anti-vibration handle

You will find other frequencies and voltages in the numerical section.

For accessories, see page 68



Type	Part number	EAN	PC	£ List Price excl. VAT
<b>MSfo 870-1c 300 Hz 200 V</b>	<b>7 820 75 00 26 0</b>	<b>4014586857053</b>	<b>09</b>	<b>1,560.00</b>

**Price includes:**

1 wheel guard, 1 pair of flanges, 1 set of keys, 1 anti-vibration handle

You will find other frequencies and voltages in the numerical section.

For accessories, see page 68



Type	Part number	EAN	PC	£ List Price excl. VAT
<b>MSfo 870-1d 300 Hz 200 V</b>	<b>7 820 77 00 26 0</b>	<b>4014586857107</b>	<b>09</b>	<b>1,556.00</b>

**Price includes:**

1 wheel guard, 1 pair of flanges, 1 set of keys, 1 anti-vibration handle

You will find other frequencies and voltages in the numerical section.

For accessories, see page 68



Type	Part number	EAN	PC	£ List Price excl. VAT
<b>MSfo 849-1c 300 Hz 200 V</b>	<b>7 820 80 00 26 0</b>	<b>4014586857145</b>	<b>09</b>	<b>1,188.00</b>

**Price includes:**

1 anti-vibration handle, 1 set of keys, 1 wheel guard, 1 pair of flanges

You will find other frequencies and voltages in the numerical section.

For accessories, see page 68



Type	Part number	EAN	PC	£ List Price excl. VAT
<b>MSfov 852-1 300 Hz 200 V</b>	<b>7 820 83 00 26 0</b>	<b>4014586857336</b>	<b>09</b>	<b>1,498.00</b>

**Price includes:**  
1 wheel guard, 1 pair of flanges, 1 set of keys

You will find other frequencies and voltages in the numerical section.  
For accessories, see page 68



Type	Part number	EAN	PC	£ List Price excl. VAT
<b>MSf 843-1c 300 Hz 200 V</b>	<b>7 820 85 00 26 0</b>	<b>4014586864402</b>	<b>09</b>	<b>1,088.00</b>

**Price includes:**  
1 wheel guard, 1 pair of flanges, 1 set of keys, 1 anti-vibration handle  
You will find other frequencies and voltages in the numerical section.  
For accessories, see page 68



Type	Part number	EAN	PC	£ List Price excl. VAT
<b>HFw 9-125 300 Hz 200 V</b>	<b>7 820 86 60 00 0</b>	<b>4014586869513</b>	<b>09</b>	<b>858.00</b>

**Price includes:**  
1 wheel guard, 1 pair of flanges, 1 anti-vibration handle, 1 set of keys  
You will find other frequencies and voltages in the numerical section.  
For accessories, see page 68



Type	Part number	EAN	PC	£ List Price excl. VAT
<b>MSfov 852-1-180 300 Hz 200 V</b>	<b>7 820 87 60 00 0</b>	<b>4014586886022</b>	<b>09</b>	<b>1,730.00</b>

**Price includes:**  
1 wheel guard, 1 pair of flanges, 1 set of keys  
You will find other frequencies and voltages in the numerical section.  
For accessories, see page 68

Grinding



	MSho 840-2 300 Hz 200 V	MSh 843-1 300 Hz 200 V	MSho 849-1 Z 300 Hz 200 V	MShyo 869-1a 300 Hz 200 V	MShyo 869-1d 300 Hz 200 V	MShyo 852-3a 300 Hz 200 V	MShyo 852-4a 300 Hz 200 V	MSho 852-1 300 Hz 200 V	
	Handy HF straight grinder for light-duty grinding work.	Lightweight and handy HF straight grinder for milling work.	Powerful HF straight grinder for medium-duty grinding work with pin tools.	The most powerful FEIN HF straight grinder for satin-finishing work with large tools.	The most powerful FEIN HF straight grinder for heavy-duty grinding work.	Powerful HF straight grinder for medium- to heavy-duty grinding work.	Powerful HF straight grinder for satin-finishing work.	Powerful HF straight grinder for medium-duty to heavy-duty high-speed grinding work.	
EAN 4014586...	... 827636	... 857947	... 858012	... 857633	... 858111	... 857657	... 858180	... 858241	
Page	67	67	67	67	67	67	67	67	
Application	roughing-down	▲▲		▲▲		▲▲	▲▲	▲▲	
	Deburring							▲▲	
	satin-finishing				▲▲			▲▲	
	cutting	▲	▲▲					▲	
Technical features	Frequency	300 Hz	300 Hz	300 Hz	300 Hz	300 Hz	300 Hz	300 Hz	
	Voltage/type of current	200 V/3~	200 V/3~	200 V/3~	200 V/3~	200 V/3~	200 V/3~	200 V/3~	
	Input	410 W	1 100 W	1 500 W	3 100 W	3 100 W	1 900 W	1 900 W	1 900 W
	Output	290 W	700 W	1 075 W	2 450 W	2 410 W	1 400 W	1 400 W	1 400 W
	Speed, no load	18 000 1/min	18 000 1/min	18 000 1/min	5 000 1/min	10 200 1/min	10 200 1/min	5 800 1/min	18 000 1/min
	Cable	5 m	5 m	5 m	5 m	5 m	5 m	5 m	5 m
	Weight according to EPTA	2,10 kg	3,00 kg	3,90 kg	8,90 kg	8,90 kg	5,20 kg	5,70 kg	5,20 kg
	Flange				M 16	M 16	M 12	M 12	M 12
	Collet for max. Ø	6 mm	6 mm	8 mm					
Grinding wheel for max. Ø	50 mm	40 mm	50 mm						

▲ suitability    ▲▲ optimal suitability



MSho 840-2



MShyo 843-1



MShyo 849-1

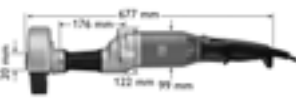









MShyo 869-1a  
MShyo 869-1d



MShyo 852-4a



MSho 852-1

	Type	Part number	EAN	PC	£ List Price excl. VAT
	<b>MSho 840-2 300 Hz 200 V</b>	<b>7 823 03 00 26 0</b>	<b>4014586827636</b>	<b>09</b>	<b>867.00</b>
	<p><b>Price includes:</b> 1 collet Ø 6 mm, 1 set of keys</p> <p>You will find other frequencies and voltages in the numerical section.</p> <p>For accessories, see page 68</p>				
	Type	Part number	EAN	PC	£ List Price excl. VAT
	<b>MSh 843-1 300 Hz 200 V</b>	<b>7 823 19 00 26 0</b>	<b>4014586857947</b>	<b>09</b>	<b>1,037.00</b>
	<p><b>Price includes:</b> 1 collet Ø 6 mm, 1 set of keys</p> <p>You will find other frequencies and voltages in the numerical section.</p> <p>For accessories, see page 68</p>				
	Type	Part number	EAN	PC	£ List Price excl. VAT
	<b>MSho 849-1 Z 300 Hz 200 V</b>	<b>7 823 20 00 26 0</b>	<b>4014586858012</b>	<b>09</b>	<b>1,195.00</b>
	<p><b>Price includes:</b> 1 collet Ø 8 mm, 1 set of keys</p> <p>You will find other frequencies and voltages in the numerical section.</p> <p>For accessories, see page 68</p>				
	Type	Part number	EAN	PC	£ List Price excl. VAT
	<b>MShyo 869-1a 300 Hz 200 V</b>	<b>7 824 37 00 26 0</b>	<b>4014586857633</b>	<b>09</b>	<b>1,766.00</b>
	<p><b>Price includes:</b> 1 wheel guard, 1 set of keys, 1 pair of flanges</p> <p>You will find other frequencies and voltages in the numerical section.</p> <p>For accessories, see page 68</p>				
	Type	Part number	EAN	PC	£ List Price excl. VAT
	<b>MShyo 869-1d 300 Hz 200 V</b>	<b>7 824 38 00 26 0</b>	<b>4014586858111</b>	<b>09</b>	<b>1,542.00</b>
	<p><b>Price includes:</b> 1 wheel guard, 1 set of keys, 1 pair of flanges</p> <p>You will find other frequencies and voltages in the numerical section.</p> <p>For accessories, see page 68</p>				
	Type	Part number	EAN	PC	£ List Price excl. VAT
	<b>MShyo 852-3a 300 Hz 200 V</b>	<b>7 824 39 00 26 0</b>	<b>4014586857657</b>	<b>09</b>	<b>1,233.00</b>
	<p><b>Price includes:</b> 1 wheel guard, 1 set of keys, 1 pair of flanges</p> <p>You will find other frequencies and voltages in the numerical section.</p> <p>For accessories, see page 68</p>				
	Type	Part number	EAN	PC	£ List Price excl. VAT
	<b>MShyo 852-4a 300 Hz 200 V</b>	<b>7 824 40 00 26 0</b>	<b>4014586858180</b>	<b>09</b>	<b>1,476.00</b>
	<p><b>Price includes:</b> 1 wheel guard, 1 pair of flanges, 1 set of keys</p> <p>You will find other frequencies and voltages in the numerical section.</p> <p>For accessories, see page 68</p>				
	Type	Part number	EAN	PC	£ List Price excl. VAT
	<b>MSho 852-1 300 Hz 200 V</b>	<b>7 824 42 00 26 0</b>	<b>4014586858241</b>	<b>09</b>	<b>1,191.00</b>
	<p><b>Price includes:</b> 1 set of keys, 1 pair of flanges, 1 wheel guard</p> <p>You will find other frequencies and voltages in the numerical section.</p> <p>For accessories, see page 68</p>				

**General accessories for HF tools**



**anti-vibration handle**  
M 8, vibration absorbing, to reduce the vibrations during longer jobs.

Part number	£ List Price excl. VAT
3 21 19 124 01 0	9.75



**anti-vibration handle**  
M 10, vibration absorbing, to reduce the vibrations during longer jobs.

Part number	£ List Price excl. VAT
3 21 19 118 01 3	39.08



**anti-vibration handle**  
M 14, vibration absorbing, to reduce the vibrations during longer jobs.

Part number	£ List Price excl. VAT
3 21 19 117 01 5	39.08



**Male connector**  
over 50 V, 16 A, 100 - 300 Hz, 10 h, 3 P+E

Part number	£ List Price excl. VAT
3 07 28 123 00 7	25.65



**Male connector**  
over 50 V, 32 A, 100 - 300 Hz, 10 h, 3 P+E

Part number	£ List Price excl. VAT
3 07 28 124 00 5	34.78



**Sleeve plug**  
over 50 V, 16 A, 100 - 300 Hz, 10 h, 3 P+E

Part number	£ List Price excl. VAT
3 07 28 130 00 0	31.54



**Sleeve plug**  
over 50 V, 32 A, 100 - 300 Hz, 10 h, 3 P+E

Part number	£ List Price excl. VAT
3 07 28 131 00 9	40.72



**Motor protection plug**  
FEIN's motor safety plugs provide reliable overload protection for high-frequency power tools. A bimetallic actuator, which is individually set to the corresponding rated current of the connected high-frequency tool, prevents premature or late activation in the event of brief overloading. The motor safety plug is fitted on the high-frequency power tool's connector cable instead of the normal male connector. The motor safety plug consists of a CEE plug, thermal actuators with temperature compensation and a rotary activation toggle. suited to the 840 series, setting range 1.6 - 2.5 A

Model	Part number	£ List Price excl. VAT
16 A	3 07 56 085 00 2	197.64
32 A	3 07 56 093 00 9	204.91



**Motor protection plug**  
FEIN's motor safety plugs provide reliable overload protection for high-frequency power tools. A bimetallic actuator, which is individually set to the corresponding rated current of the connected high-frequency tool, prevents premature or late activation in the event of brief overloading. The motor safety plug is fitted on the high-frequency power tool's connector cable instead of the normal male connector. The motor safety plug consists of a CEE plug, thermal actuators with temperature compensation and a rotary activation toggle. suited to the HF 9, 843, 849 series, setting range 4 - 6.3 A

Model	Part number	£ List Price excl. VAT
16 A	3 07 56 087 00 9	197.64
32 A	3 07 56 095 00 1	204.91



**Motor protection plug**  
FEIN's motor safety plugs provide reliable overload protection for high-frequency power tools. A bimetallic actuator, which is individually set to the corresponding rated current of the connected high-frequency tool, prevents premature or late activation in the event of brief overloading. The motor safety plug is fitted on the high-frequency power tool's connector cable instead of the normal male connector. The motor safety plug consists of a CEE plug, thermal actuators with temperature compensation and a rotary activation toggle. suited to the 852 series, setting range 6.3 - 9 A

Model	Part number	£ List Price excl. VAT
16 A	3 07 56 088 00 7	222.13
32 A	3 07 56 096 00 4	230.91



**Motor protection plug**  
FEIN's motor safety plugs provide reliable overload protection for high-frequency power tools. A bimetallic actuator, which is individually set to the corresponding rated current of the connected high-frequency tool, prevents premature or late activation in the event of brief overloading. The motor safety plug is fitted on the high-frequency power tool's connector cable instead of the normal male connector. The motor safety plug consists of a CEE plug, thermal actuators with temperature compensation and a rotary activation toggle. suited to the 869 series, setting range 9 - 12.5 A

Model	Part number	£ List Price excl. VAT
16 A	3 07 56 089 00 1	222.13
32 A	3 07 56 097 00 8	230.91



**Motor protection plug**  
FEIN's motor safety plugs provide reliable overload protection for high-frequency power tools. A bimetallic actuator, which is individually set to the corresponding rated current of the connected high-frequency tool, prevents premature or late activation in the event of brief overloading. The motor safety plug is fitted on the high-frequency power tool's connector cable instead of the normal male connector. The motor safety plug consists of a CEE plug, thermal actuators with temperature compensation and a rotary activation toggle. suited to the 870 series, setting range 12.5 - 16 A

Model	Part number	£ List Price excl. VAT
16 A	3 07 56 090 00 3	222.13
32 A	3 07 56 098 00 6	230.91



**General accessories for frequency converters**



**Assembly socket**  
over 50 V, 16 A, 100 - 300 Hz, 10 h, 3 P+E

Part number	£ List Price excl. VAT
3 07 28 141 00 8	49.75



**Wall socket**  
over 50 V, 16 A, 100 - 300 Hz, 10 h, 3 P+E

Part number	£ List Price excl. VAT
3 07 28 137 00 5	35.48

**Wall socket**  
over 50 V, 32 A, 100 - 300 Hz, 10 h, 3 P+E

Part number	£ List Price excl. VAT
3 07 28 138 00 3	47.13

**Accessories for MO 83 - 25 KSR, MO 83 - 30 KSR,  
MO 83 - 45 KSR**

**Anti vibration mounts**  
4 items required for each frequency converter.

Part number	£ List Price excl. VAT
3 14 15 020 00 8	40.82

**Accessories for MO 83 - 20 KSR, MO 83 - 7.5 KSR,  
MO 83 - 11 KSR, MO 83 - 15 KSR**

**Anti vibration mounts**  
4 items required for each frequency converter.

Part number	£ List Price excl. VAT
3 14 15 081 00 1	17.42

Grinding





# There are many different kinds of metal and our tools can tell the difference.

Corrugated and trapezoid sheet metals, steel plates and profiles all have special requirements. FEIN knows that it's all in the sheet metal working - and that's been the case since 1927. From this long-standing experience, a range of products has been born, which is unsurpassed in its diversity and professionalism. Compact nibblers, the most versatile of tools has unrivalled curve-cutting precision. Metal shears that combine speed, robustness and reliability. Lastly, throatless shears, which are ideal for cutting where swarf loss is to be avoided. No matter what their speciality, all the FEIN metalworking tools have one thing in common: They are perfectly designed for all tasks to be undertaken during the working day.



---

## Slitting shears Page 72

Clean, distortion-free cutting of sheet metals, profiles and pipes - with just one continuous cut.



---

## Sheet metal shears Page 75

The right choice for everyone who values the highest cutting performance in sheet metal and stainless steel.



---

## Nibblers Page 78

Extremely versatile and curve-compatible, particularly suited for trapezoid sheet metals, corrugated sheet metals, profiles and curved single rolled sheets.



	ABSS 18 1.6 E Select	BSS 1.6 E	BSS 1.6 CE	BSS 2.0 E	
	Easy-to-use, curve-compatible cordless slitting shears for distortion-free cuts and cut-outs in sheet metal up to 1.6 mm.	Easy-to-use and curve-compatible slitting shears for distortion-free cutting.	Easy-to-use and curve-compatible slitting shears with integrated chip clipper.	Powerful slitting shears for stainless steel processing, spiral seam pipes and profiles.	
<b>EAN 4014586...</b>	... 886640				
<b>Page</b>	73	73	73	73	
<b>Application</b>	Cuts	▲▲	▲▲	▲▲	
	Curve cuts	▲	▲	▲	
	Cut-outs	▲▲	▲▲	▲▲	
<b>Equip-ment</b>	FEIN high-power motor		●	●	
	Chip clipper			●	
<b>Technical features</b>	Input		350 W	350 W	
	Battery voltage	18 V			
	Battery compatibility	Li-ion / HighPower Li-ion			
	Battery interface	MultiVolt			
	Strokes	2 200 - 3 500 1/min	2 100 - 4 500 1/min	2 100 - 4 500 1/min	1 300 - 2 600 1/min
	Cutting speed	5 - 8 m/min	6 - 10 m/min	6 - 10 m/min	2 - 4 m/min
	Steel up to 400 N/mm <sup>2</sup>	1,6 mm	1,6 mm	1,6 mm	2 mm
	Steel up to 600 N/mm <sup>2</sup>	1,2 mm	1,2 mm	1,2 mm	1,5 mm
	Steel up to 800 N/mm <sup>2</sup>	0,8 mm	1 mm	1 mm	1,3 mm
	Non-ferrous metals up to 250 N/mm <sup>2</sup>	2 mm	2 mm	2 mm	3 mm
	Cutting width	5 mm	5 mm	5 mm	5 mm
	Rad. of smallest curve	90 (30) <sup>1</sup> mm	90 (30) <sup>1</sup> mm	90 (30) <sup>1</sup> mm	245 mm
	Immersion Ø	15 (8) <sup>1</sup> mm	15 (8) <sup>1</sup> mm	15 (8) <sup>1</sup> mm	12 mm
Weight according to EPTA		1,50 kg	1,50 kg	1,70 kg	
Weight without storage battery	1,20 kg				
<b>Material</b>	Profile	▲	▲	▲	
	Folded spiral-seam pipes	▲	▲	▲	
	Single rolled sheets	▲▲	▲▲	▲▲	
	Single rolled sheets - slightly corrugated	▲▲	▲▲	▲▲	

▲ suitability    ▲▲ optimal suitability    ● included    <sup>1</sup> with blade for curves

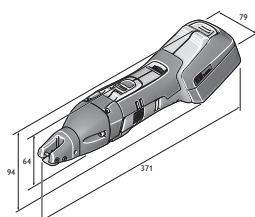

ABSS 18-1.6 E

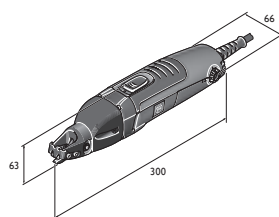

BSS 1.6 E

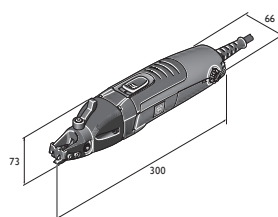

BSS 1.6 CE

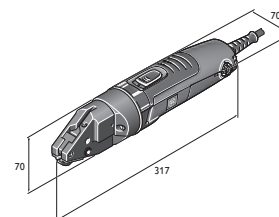

BSS 2.0 E

**FEIN SELECT<sup>+</sup>**



Type	Part number	EAN	PC	£ List Price excl. VAT
<b>ABSS 18 1.6 E Select</b>	<b>7 130 03 61 00 0</b>	<b>4014586886640</b>	<b>01</b>	<b>598.00</b>

**Price includes:**  
1 ABSS 18 1.6 E, 1 Knife, straight, up to 1.6 mm, 1 pair of cutting bars, 1 key, 1 plastic carrying case  
For accessories, see page 73



Type	Part number	PC	£ List Price excl. VAT
<b>BSS 1.6 E</b>	<b>7 230 31 61</b>	<b>01</b>	<b>732.00</b>

**Price includes:**  
1 Knife, straight, up to 1.6 mm, 1 pair of cutting bars, 1 key  
For accessories, see page 73



Type	Part number	PC	£ List Price excl. VAT
<b>BSS 1.6 CE</b>	<b>7 230 32 61</b>	<b>01</b>	<b>815.00</b>

**Price includes:**  
1 Knife, straight, up to 1.6 mm, 1 pair of cutting bars, 1 key  
For accessories, see page 73



Type	Part number	PC	£ List Price excl. VAT
<b>BSS 2.0 E</b>	<b>7 230 33 61</b>	<b>01</b>	<b>925.00</b>

**Price includes:**  
1 cutter blade, 1 pair of cutting bars  
For accessories, see page 73

Sheet metal  
working

**Slitting shears**

**General accessories**



**Cordless ALED 12-18 V LED lamp**  
Compact and durable cordless LED lamp with swivel-mounted lamp head. Compatible with all 12 / 14 / 18 V FEIN Li-ion batteries, including hook for attaching the lamp. Extremely lightweight at 130 g and very bright at 900 Lux. Colour temperature is the equivalent of daylight. The brightness can be set to 2 levels.

Part number	£ List Price excl. VAT
9 26 04 200 02 0	56.59



**Tool case**  
Plastic, inner dimensions: 470 x 275 x 116 mm

Part number	£ List Price excl. VAT
3 39 01 118 01 0	46.09



**Plastic box**  
Box insert with lockable lid for small parts and accessories, suitable for tool box 3 39 01 118 01 0, max 5 items/box.

Part number	£ List Price excl. VAT
3 39 01 119 00 0	4.54



**Cutting paste**  
Lubricating agents for working on sheet metals.

Part number	£ List Price excl. VAT
3 21 32 020 12 9	15.48



**Quick charger ALG 50**  
For all FEIN Li-ion batteries. Charge time from 35 min.

Part number	£ List Price excl. VAT
9 26 04 129 01 0	45.53



**Quick charger ALG 30**  
For FEIN NiCd and Li-ion batteries. Charge time from 25 min.

Part number	£ List Price excl. VAT
9 26 04 096 01 0	163.10

**18 V battery**



**Battery pack**

Li-ion battery with charge status indicator and FEIN SafetyCell technology. Protects the battery and tool from overload, overheating and total discharge. Can be used with all FEIN 18 V cordless tools.

Current/Voltages V	Capacity Ah	Part number	£ List Price excl. VAT
18	5	9 26 04 173 02 0	111.38
18	2,5	9 26 04 171 02 0	76.34

**FEIN Select<sup>+</sup>**



**Battery starter set**

2 x Li-ion batteries with ALG 50 rapid charger.

Current/Voltages V	Capacity Ah	Part number	£ List Price excl. VAT
18	5	9 26 04 301 03 0	268.29
18	2,5	9 26 04 301 04 0	197.14

**Accessories for ABSS**



**Cutting bars**

1 pair

Part number	£ List Price excl. VAT
3 13 08 153 01 4	80.45



**Cutting blade**

for stainless steel up to 800 N/mm<sup>2</sup>

Plate thickness mm	Part number	£ List Price excl. VAT
0,8	3 13 08 152 00 1	88.19



**Blade for curves**

for steel sheet up to 400 N/mm<sup>2</sup>

Plate thickness mm	Part number	£ List Price excl. VAT
1,0	3 13 08 151 00 8	79.46



**Cutting blade**

for steel sheet up to 400 N/mm<sup>2</sup>

Plate thickness mm	Part number	£ List Price excl. VAT
1,6	3 13 08 150 00 9	74.77

**Accessories for BSS 1.6 E, BSS 1.6 CE**



**Cutting blade**

for steel sheet up to 400 N/mm<sup>2</sup>

Plate thickness mm	Part number	£ List Price excl. VAT
1,6	3 13 08 150 00 9	74.77



**Cutting blade**

for stainless steel up to 800 N/mm<sup>2</sup>

Plate thickness mm	Part number	£ List Price excl. VAT
0,8	3 13 08 152 00 1	88.19



**Blade for curves**

for steel sheet up to 400 N/mm<sup>2</sup>

Plate thickness mm	Part number	£ List Price excl. VAT
1,0	3 13 08 151 00 8	79.46

**Accessories for BSS 1.6 CE**



**Cutting bars**

1 pair

Part number	£ List Price excl. VAT
3 13 08 153 02 0	80.45

**Accessories for BSS 1.6 E**



**Cutting bars**

1 pair

Part number	£ List Price excl. VAT
3 13 08 153 01 4	80.45

**Accessories for BSS 2.0 E**



**Cutting blade**

for steel sheet up to 400 N/mm<sup>2</sup>

Plate thickness mm	Part number	£ List Price excl. VAT
2,0	3 13 08 110 00 3	103.93



**Cutting blade**

for stainless steel up to 800 N/mm<sup>2</sup>

Plate thickness mm	Part number	£ List Price excl. VAT
1,3	3 13 08 123 00 8	163.33



**Cutting bars**

Pack of 2

Part number	£ List Price excl. VAT
3 13 08 113 00 9	110.80

**Blade pin**

Part number	£ List Price excl. VAT
3 13 08 111 00 2	16.51



Sheet metal working

	ABLS 18 1.6 E Select	BLS 1.6 E	BLS 2.5 E	BLS 3.5	BLS 4.2	
	Ergonomic, curve-compatible cordless sheet metal shears for cutting and trimming thin sheets.	Easy-to-use, curve-compatible sheet metal shears for cutting and trimming thin sheets.	Easy-to-use, curve-compatible sheet metal shears for working with stainless steel.	Universal sheet metal shears with tool-free setting of material thickness.	Powerful sheet metal shears for cutting, separating and trimming sheet metal constructions.	
EAN 4014586...	... 886664					
Page	76	76	76	76	76	
Appli- cation	Cuts	▲▲	▲▲	▲▲	▲▲	▲▲
	Curve cuts	▲	▲	▲	▲	▲
Equipment	FEIN high-power motor		●	●	●	●
	Reversing blade		4x	4x	2x	2x
	Chip suppressor				●	●
Technical features	Input		350 W	350 W	1 200 W	1 200 W
	Battery voltage	18 V				
	Battery compatibility	Li-ion/ HighPower Li-ion				
	Battery interface	MultiVolt				
	Strokes	2 200 - 3 700 1/min	2 300 - 4 800 1/min	800 - 1 700 1/min	1 500 1/min	750 1/min
	Cutting speed	6 - 9 m/min	8 - 12 m/min	3 - 6 m/min	4 - 5 m/min	4 - 5 m/min
	Steel up to 400 N/mm <sup>2</sup>	1,6 mm	1,6 mm	2,5 mm	3,5 mm	4,2 mm
	Steel up to 600 N/mm <sup>2</sup>	1,2 mm	1,2 mm	2 mm	3 mm	3 mm
	Steel up to 800 N/mm <sup>2</sup>	1 mm	1 mm	1,6 mm	2 mm	2 mm
	Non-ferrous metals up to 250 N/mm <sup>2</sup>	2 mm	2 mm	3 mm	4 mm	5 mm
Rad. of smallest curve	15 mm	15 mm	20 mm	30 mm	25 mm	
Weight according to EPTA		1,70 kg	2,10 kg	5,40 kg	5,20 kg	
Weight without storage battery	1,40 kg					
Ma- terial	Single rolled sheets	▲▲	▲▲	▲▲	▲▲	▲▲
	Single rolled sheets - slightly corrugated	▲▲	▲▲	▲▲	▲▲	▲▲

▲ suitability    ▲▲ optimal suitability    ● included

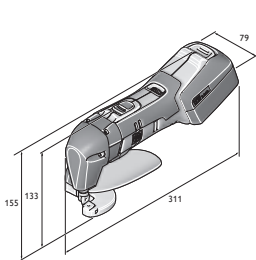

ABLS 18-1.6 E

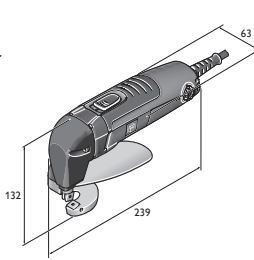

BLS 1.6 E

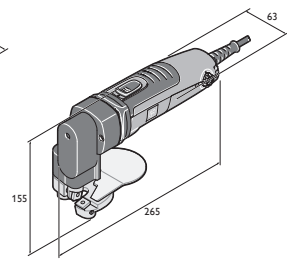

BLS 2.5 E

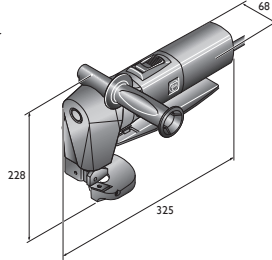

BLS 3.5

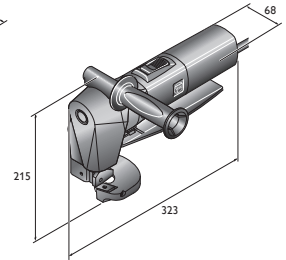

BLS 4.2

**FEIN SELECT<sup>+</sup>**



Type	Part number	EAN	PC	£ List Price excl. VAT
<b>ABLS 18 1.6 E Select</b>	<b>7 130 04 61 00 0</b>	<b>4014586886664</b>	<b>01</b>	<b>539.00</b>

**Price includes:**  
1 ABL 18 1.6 E, 1 pair of blades, 1 set of wrenches, 1 hand guard, 1 plastic carrying case  
For accessories, see page 76



Type	Part number	PC	£ List Price excl. VAT
<b>BLS 1.6 E</b>	<b>7 230 34 61</b>	<b>01</b>	<b>682.00</b>

**Price includes:**  
1 pair of blades, 1 set of wrenches, 1 hand guard  
For accessories, see page 76



Type	Part number	PC	£ List Price excl. VAT
<b>BLS 2.5 E</b>	<b>7 230 35 61</b>	<b>01</b>	<b>1,047.00</b>

**Price includes:**  
1 pair of blades, 1 set of wrenches, 1 hand guard  
For accessories, see page 76



Type	Part number	PC	£ List Price excl. VAT
<b>BLS 3.5</b>	<b>7 230 23 00</b>	<b>01</b>	<b>1,846.00</b>

**Price includes:**  
1 pair of blades, 1 hand guard, 1 additional handle, 1 set of wrenches  
For accessories, see page 76



Type	Part number	PC	£ List Price excl. VAT
<b>BLS 4.2</b>	<b>7 230 24</b>	<b>01</b>	<b>1,916.00</b>

**Price includes:**  
1 pair of blades, 1 hand guard, 1 additional handle, 1 gauge, 3 wrenches  
For accessories, see page 76

**Sheet metal shears**

**General accessories**



**Cordless ALED 12-18 V LED lamp**  
Compact and durable cordless LED lamp with swivel-mounted lamp head. Compatible with all 12 / 14 / 18 V FEIN Li-ion batteries, including hook for attaching the lamp. Extremely lightweight at 130 g and very bright at 900 Lux. Colour temperature is the equivalent of daylight. The brightness can be set to 2 levels.

Part number	£ List Price excl. VAT
9 26 04 200 02 0	56.59



**Plastic box**  
Box insert with lockable lid for small parts and accessories, suitable for tool box 3 39 01 118 01 0, max 5 items/box.

Part number	£ List Price excl. VAT
3 39 01 119 00 0	4.54



**Tool case**  
Plastic, inner dimensions: 470 x 275 x 116 mm

Part number	£ List Price excl. VAT
3 39 01 118 01 0	46.09



**Cutting paste**  
Lubricating agents for working on sheet metals.

Part number	£ List Price excl. VAT
3 21 32 020 12 9	15.48



**Quick charger ALG 50**  
For all FEIN Li-ion batteries. Charge time from 35 min.

Part number	£ List Price excl. VAT
9 26 04 129 01 0	45.53



**Quick charger ALG 30**  
For FEIN NiCd and Li-ion batteries. Charge time from 25 min.

Part number	£ List Price excl. VAT
9 26 04 096 01 0	163.10

**18 V battery**



**Battery pack**  
Li-ion battery with charge status indicator and FEIN SafetyCell technology. Protects the battery and tool from overload, overheating and total discharge. Can be used with all FEIN 18 V cordless tools.

Current/Voltages V	Capacity Ah	Part number	£ List Price excl. VAT
18	5	9 26 04 173 02 0	111.38
18	2,5	9 26 04 171 02 0	76.34



**Battery starter set**  
2 x Li-ion batteries with ALG 50 rapid charger.

Current/Voltages V	Capacity Ah	Part number	£ List Price excl. VAT
18	5	9 26 04 301 03 0	268.29
18	2,5	9 26 04 301 04 0	197.14

**Accessories for ABL5**



**Plunger blade and fixed blade**  
for steel sheet up to 800 N/mm<sup>2</sup>

Part number	£ List Price excl. VAT
3 13 08 072 00 0	30.95

**Accessories for BLS 1.6 E**



**Plunger blade and fixed blade**  
for steel sheet up to 800 N/mm<sup>2</sup>

Part number	£ List Price excl. VAT
3 13 08 072 00 0	30.95

**Accessories for BLS 2.5 E**



**Plunger blade and fixed blade**  
for steel sheet up to 800 N/mm<sup>2</sup>

Plate thickness mm	Part number	£ List Price excl. VAT
1,6	6 36 01 101 00 9	25.25

**Accessories for BLS 3.5**



**Fixed blade**  
for steel sheet up to 400 N/mm<sup>2</sup>

Plate thickness mm	Part number	£ List Price excl. VAT
3,5	3 13 08 136 00 2	58.05



**Fixed blade**  
for stainless steel up to 800 N/mm<sup>2</sup>

Plate thickness mm	Part number	£ List Price excl. VAT
2,0	3 13 08 143 00 6	66.76



**Plunger blade**  
for steel sheet up to 400 N/mm<sup>2</sup>

Plate thickness mm	Part number	£ List Price excl. VAT
3,5	3 13 08 146 00 1	58.83



**Plunger blade**  
for stainless steel up to 800 N/mm<sup>2</sup>

Plate thickness mm	Part number	£ List Price excl. VAT
2,0	3 13 08 147 00 5	70.26

**Accessories for BLS 4.2**



**Fixed blade**

Part number	£ List Price excl. VAT
3 13 08 092 00 8	69.24



**Plunger blade**  
for steel sheet up to 400 N/mm<sup>2</sup>

Plate thickness mm	Part number	£ List Price excl. VAT
4,2	3 13 08 096 00 7	116.07



**Plunger blade**  
for stainless steel up to 800 N/mm<sup>2</sup>

Plate thickness mm	Part number	£ List Price excl. VAT
2,0	3 13 08 098 00 9	180.86



		<b>ABLK 18 1.6 E Select</b>	<b>ABLK 18 1.3 CSE Select</b>	<b>ABLK 18 1.3 TE Select</b>	<b>BLK 1.6 E</b>
		Compact and curve-compatible nibbler for roof and façade construction. Precise cuts in trapezoid and corrugated sheet metals and profiles.	Compact and curve-compatible nibbler for roof and façade construction. Precise cuts in corrugated sheet metal up to 1.3 mm.	Compact and curve-compatible nibbler for roof and façade construction. Precise cuts in trapezoid sheet metal up to 1.3 mm.	Universal nibbler for sheets, profiles, trapezoid and corrugated sheet metals.
<b>EAN 4014586...</b>		... 886688	... 886701	... 886725	
<b>Page</b>		80	80	80	80
<b>Applica- tion</b>	Curve cuts	▲▲	▲▲	▲▲	▲
	Cut-outs	▲▲	▲	▲	▲▲
<b>Equip- ment</b>	QuickIN	●	●	●	●
	Cutting direction	8 x 45°	8 x 45°	8 x 45°	8 x 45°
	Rotating round punch	●	●	●	●
<b>Technical features</b>					
Input					350 W
Battery voltage		18 V	18 V	18 V	
Battery compatibility		Li-ion/HighPower Li-ion	Li-ion/HighPower Li-ion	Li-ion/HighPower Li-ion	
Battery interface		MultiVolt	MultiVolt	MultiVolt	
Strokes		800 - 1 300 1/min	900 - 1 600 1/min	900 - 1 600 1/min	800 1/min
Cutting speed		1,5 m/min	1,9 m/min	1,9 m/min	1,9 m/min
Steel up to 400 N/mm <sup>2</sup>		1,6 mm	1,3 mm	1,3 mm	1,6 mm
Steel up to 600 N/mm <sup>2</sup>		1 mm	0,8 mm	0,8 mm	1 mm
Steel up to 800 N/mm <sup>2</sup>		0,7 mm	0,6 mm	0,6 mm	0,7 mm
Non-ferrous metals up to 250 N/mm <sup>2</sup>		2,5 mm	2 mm	2 mm	2,5 mm
Cutting width		5 mm	4 mm	4 mm	5 mm
Immersion Ø with die		22 mm	19 mm	19 mm	22 mm
Rad. of smallest curve (inside/outside)		30 / 35 mm	15 / 20 mm	25 / 30 mm	30 / 35 mm
Weight according to EPTA					1,80 kg
Weight without storage battery		1,65 kg	1,60 kg	1,60 kg	
<b>Material</b>	Trapezoid sheet metal up to 85 mm deep channels	▲▲	▲	▲▲	▲▲
	Corrugated sheet metal	▲▲	▲▲	▲	▲▲
	Profile				
	Single rolled sheets	▲▲	▲▲	▲▲	▲▲
	Single rolled sheets - slightly corrugated	▲▲	▲▲	▲▲	▲▲
Trapezoid sheet metal up to 160 mm deep channels	▲▲	▲	▲▲	▲▲	

▲ suitability    ▲▲ optimal suitability    ● included

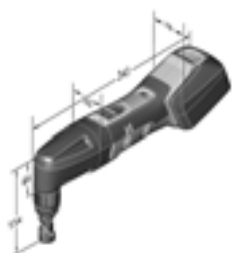

ABLK 18 1.6 E

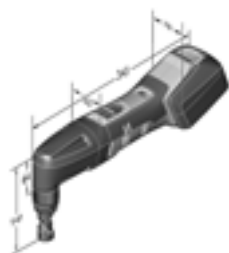

ABLK 18 1.3 CSE

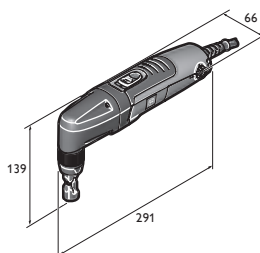

BLK 1.3 CSE

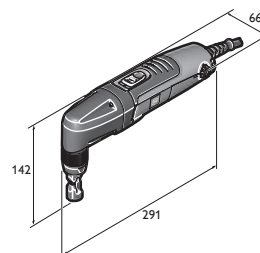

BLK 1.3 TE



	<b>BLK 1.6 LE</b>	<b>BLK 1.3 TE</b>	<b>BLK 1.3 CSE</b>	<b>BLK 2.0 E</b>	<b>BLK 3.5</b>	<b>BLK 5.0</b>
	Compact nibbler for deep-channel trapezoidal sheet metals in roof and façade construction.	Compact and rapid nibbler for trapezoid sheet metals.	Compact and rapid nibbler for corrugated sheet metals.	Compact nibbler with unlimited curve precision for corners and edges.	Powerful nibbler with unlimited curve-compatibility for grooves and cut-outs.	Powerful nibbler for heavy dismantling and cutting applications.
	80	80	81	81	81	81
	▲▲	▲▲	▲▲	▲▲	▲▲	▲
	▲	▲	▲	▲▲	▲	
	●	●	●	●	●	●
	8 x 45°	8 x 45°	8 x 45°	8 x 45°	3 x 90°	3 x 90°
	●	●	●			
	350 W	350 W	350 W	350 W	1 200 W	1 200 W
	800 - 1 500 1/min	1 000 - 1 800 1/min	1 000 - 1 800 1/min	500 - 1 000 1/min	750 1/min	750 1/min
	2,7 m/min	2,3 m/min	2,3 m/min	1 m/min	1,3 m/min	1,3 m/min
	1,6 mm	1,3 mm	1,3 mm	2 mm	3,5 mm	5 mm
	1 mm	0,8 mm	0,8 mm	1,5 mm	2,3 mm	3,3 mm
	0,7 mm	0,6 mm	0,6 mm	1 mm	1,8 mm	2,5 mm
	2,5 mm	2 mm	2 mm	2,5 mm	3,5 mm	7 mm
	5 mm	4 mm	4 mm	8 mm	14 mm	8 mm
	24 mm	19 mm	19 mm	18 mm	30 mm	43 mm
	65 / 70 mm	25 / 30 mm	15 / 20 mm	4 / 0 mm	7 / 0 mm	86 / 94 mm
	1,90 kg	1,80 kg	1,80 kg	1,80 kg	3,50 kg	3,80 kg
	▲▲	▲▲	▲			
	▲▲	▲	▲▲	▲	▲	▲
	▲					▲
	▲▲	▲▲	▲▲	▲▲	▲▲	▲▲
	▲▲	▲▲	▲▲	▲▲	▲▲	▲▲
		▲▲	▲			

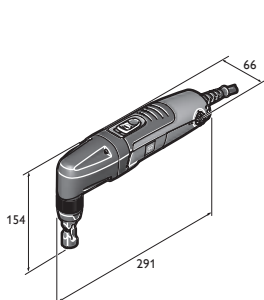

BLK 1.6 E

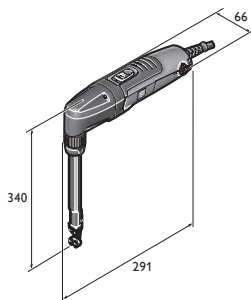

BLK 1.6 LE

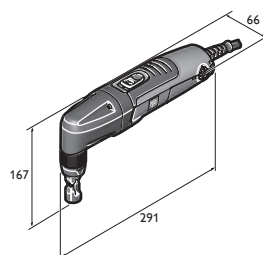

BLK 2.0 E

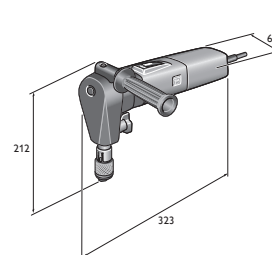

BLK 3.5

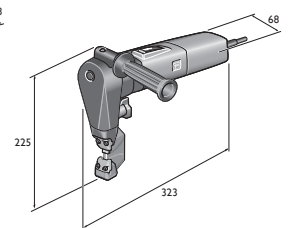

BLK 5.0

**FEIN SELECT<sup>+</sup>**

Type	Part number	EAN	PC	£ List Price excl. VAT
<b>ABLK 18 1.6 E Select</b>	<b>7 132 04 61 00 0</b>	<b>4014586886688</b>	<b>01</b>	<b>539.00</b>

**Price includes:**

1 die holder for sheet metal and corrugated sheet metal, 1 die (3 01 09 141 00 3), 1 punch (6 36 02 048 00 4), 1 plastic carrying case

For accessories, see page 82

**FEIN SELECT<sup>+</sup>**

Type	Part number	EAN	PC	£ List Price excl. VAT
<b>ABLK 18 1.3 CSE Select</b>	<b>7 132 05 61 00 0</b>	<b>4014586886701</b>	<b>01</b>	<b>539.00</b>

**Price includes:**

1 die for corrugated sheet metal (3 01 09 169 00 9), 1 punch (6 36 02 050 00 0), 1 plastic carrying case

For accessories, see page 82

**FEIN SELECT<sup>+</sup>**

Type	Part number	EAN	PC	£ List Price excl. VAT
<b>ABLK 18 1.3 TE Select</b>	<b>7 132 06 61 00 0</b>	<b>4014586886725</b>	<b>01</b>	<b>539.00</b>

**Price includes:**

1 die for trapezoidal sheet metal (3 01 09 170 00 1), 1 punch (6 36 02 050 00 0), 1 plastic carrying case

For accessories, see page 82



Type	Part number	PC	£ List Price excl. VAT
<b>BLK 1.6 E</b>	<b>7 232 38 60</b>	<b>01</b>	<b>659.00</b>

**Price includes:**

1 die holder for sheet metal and corrugated sheet metal, 1 die (3 01 09 141 00 3), 1 punch (6 36 02 048 00 4)

For accessories, see page 82



Type	Part number	PC	£ List Price excl. VAT
<b>BLK 1.6 LE</b>	<b>7 232 39 60</b>	<b>01</b>	<b>1.029.00</b>

**Price includes:**

1 cutting head, 1 die for trapezoidal sheet metal (3 13 09 122 00 5), 1 punch (6 36 02 049 00 8), 1 wearing plate

For accessories, see page 82



Type	Part number	PC	£ List Price excl. VAT
<b>BLK 1.3 TE</b>	<b>7 232 41 60</b>	<b>01</b>	<b>711.00</b>

**Price includes:**

1 die for trapezoidal sheet metal (3 01 09 170 00 1), 1 punch (6 36 02 050 00 0)

For accessories, see page 82



Type	Part number	PC	£ List Price excl. VAT
<b>BLK 1.3 CSE</b>	<b>7 232 42 60</b>	<b>01</b>	<b>711.00</b>

**Price includes:**

1 die for corrugated sheet metal (3 01 09 169 00 9), 1 punch (6 36 02 050 00 0)

For accessories, see page 82



Type	Part number	PC	£ List Price excl. VAT
<b>BLK 2.0 E</b>	<b>7 232 40 60</b>	<b>01</b>	<b>915.00</b>

**Price includes:**

1 cutting head, 1 die (3 13 09 040 00 2), 1 punch (6 36 02 051 00 9)

For accessories, see page 82



Type	Part number	PC	£ List Price excl. VAT
<b>BLK 3.5</b>	<b>7 232 30 00</b>	<b>01</b>	<b>1,937.00</b>

**Price includes:**

1 cutting head, 1 die (3 13 09 093 00 3), 1 punch (3 13 09 097 00 2), 1 additional handle

For accessories, see page 82



Type	Part number	PC	£ List Price excl. VAT
<b>BLK 5.0</b>	<b>7 232 31 00</b>	<b>01</b>	<b>2,941.00</b>

**Price includes:**

1 cutting head, 1 die (3 13 09 107 00 0), 1 punch (3 13 09 110 00 4), 1 additional handle

For accessories, see page 82

## General accessories

**Cordless ALED 12-18 V LED lamp**

Compact and durable cordless LED lamp with swivel-mounted lamp head. Compatible with all 12 / 14 / 18 V FEIN Li-ion batteries, including hook for attaching the lamp. Extremely lightweight at 130 g and very bright at 900 Lux. Colour temperature is the equivalent of daylight. The brightness can be set to 2 levels.

Part number	£ List Price excl. VAT
9 26 04 200 02 0	56.59

**Tool case**

Plastic, inner dimensions: 470 x 275 x 116 mm

Part number	£ List Price excl. VAT
3 39 01 118 01 0	46.09

**Plastic box**

Box insert with lockable lid for small parts and accessories, suitable for tool box 3 39 01 118 01 0, max 5 items/box.

Part number	£ List Price excl. VAT
3 39 01 119 00 0	4.54

**Cutting paste**

Lubricating agents for working on sheet metals.

Part number	£ List Price excl. VAT
3 21 32 020 12 9	15.48

**Quick charger ALG 30**

For FEIN NiCd and Li-ion batteries. Charge time from 25 min.

Part number	£ List Price excl. VAT
9 26 04 096 01 0	163.10

**Quick charger ALG 50**

For all FEIN Li-ion batteries. Charge time from 35 min.

Part number	£ List Price excl. VAT
9 26 04 129 01 0	45.53

## 18 V battery

**Battery pack**

Li-ion battery with charge status indicator and FEIN SafetyCell technology. Protects the battery and tool from overload, overheating and total discharge. Can be used with all FEIN 18 V cordless tools.

Current/Voltages V	Capacity Ah	Part number	£ List Price excl. VAT
18	5	9 26 04 173 02 0	111.38
18	2,5	9 26 04 171 02 0	76.34

**Battery starter set**

2 x Li-ion batteries with ALG 50 rapid charger.

Current/Voltages V	Capacity Ah	Part number	£ List Price excl. VAT
18	5	9 26 04 301 03 0	268.29
18	2,5	9 26 04 301 04 0	197.14

## Accessories for (A)BLK 1.6 E

**Punch**

No. in pack pcs	Part number	£ List Price excl. VAT
1	6 36 02 048 00 4	18.41
5	6 36 02 048 04 0	87.36
10	6 36 02 048 05 0	152.18

**Die**

No. in pack pcs	Part number	£ List Price excl. VAT
1	3 01 09 141 00 3	55.81
2	3 01 09 141 02 0	88.79
5	3 01 09 141 03 0	194.45

**Punches and dies**

in set, each consisting of 1x punch 6 36 02 048 004 and 1x die 3 01 09 141 003.

Part number	£ List Price excl. VAT
6 36 02 048 01 3	68.34

**Die holder**

for trapezoidal sheet metal and corrugated sheet metal

Part number	£ List Price excl. VAT
3 01 09 154 00 7	220.92

**Profile set 160**

For deep-channel trapezoidal sheet metals (85-160 mm), incl. 1 punch, die and wearing plate.

Part number	£ List Price excl. VAT
9 26 02 071 01 9	465.00

## Accessories for BLK 1.6 LE

**Punches and dies**

in the set, for profile set 160, including wear plate, screws and key  
Profile set 160

Part number	£ List Price excl. VAT
6 36 02 049 01 7	150.16

**Punch**

No. in pack pcs	Part number	£ List Price excl. VAT
1	6 36 02 049 00 8	64.72
2	6 36 02 049 04 0	116.95
5	6 36 02 049 05 0	259.22

**Die**

No. in pack pcs	Part number	£ List Price excl. VAT
1	3 13 09 122 00 5	75.02
2	3 13 09 122 02 0	135.24
5	3 13 09 122 03 0	319.83

**Wearing plate**

Profile set 160

Part number	£ List Price excl. VAT
3 13 09 121 00 2	12.76

**Accessories for (A)BLK 1.3 CSE**

**Punch**  
for steel sheet up to 400 N/mm<sup>2</sup>

Plate thickness mm	No. in pack pcs	Part number	£ List Price excl. VAT
1,3	1	6 36 02 050 00 0	16.26
1,3	5	6 36 02 050 03 0	77.50
1,3	10	6 36 02 050 01 0	135.24

**Die**  
for corrugated sheet metal

No. in pack pcs	Part number	£ List Price excl. VAT
1	3 01 09 169 00 9	166.09
2	3 01 09 169 04 0	266.31

**Punches and dies in a set**  
consisting of 5 x punches 6 36 02 050 00 0 and  
1 x die 3 01 09 169 00 9.

Part number	£ List Price excl. VAT
3 01 09 169 03 0	209.90

**Accessories for (A)BLK 1.3 TE**

**Punches and dies in a set**  
consisting of 5 x punches 6 36 02 050 00 0 and  
1 x die 3 01 09 170 00 1.

Part number	£ List Price excl. VAT
3 01 09 170 03 0	229.51

**Die**  
for trapezoidal sheet metal

No. in pack pcs	Part number	£ List Price excl. VAT
1	3 01 09 170 00 1	188.76
2	3 01 09 170 04 0	300.08

**Accessories for BLK 2.0 E**

**Die**  
RSS 636

Part number	£ List Price excl. VAT
3 13 09 040 00 2	58.62



**Punch**

Part number	£ List Price excl. VAT
6 36 02 051 00 9	55.43



**Punches and dies in a set**  
Consisting of: 1 die 6 36 02 051 00 9 and  
1 punch 3 13 09 040 00 2

Part number	£ List Price excl. VAT
6 36 02 051 01 8	113.04

**Accessories for BLK 3.5**

**Punch**  
for steel sheet up to 400 N/mm<sup>2</sup>

Part number	£ List Price excl. VAT
3 13 09 097 00 2	61.13



**Punch**  
for stainless steel up to 800 N/mm<sup>2</sup>

Part number	£ List Price excl. VAT
3 13 09 098 00 0	89.04



**Die**  
for steel sheet up to 400 N/mm<sup>2</sup>

Part number	£ List Price excl. VAT
3 13 09 093 00 3	67.36



**Die**  
for stainless steel up to 800 N/mm<sup>2</sup>

Part number	£ List Price excl. VAT
3 13 09 094 00 1	76.77

**Accessories for BLK 5.0**

**Punches and dies in a set**  
up to 5.0 mm steel plate (400 N/mm<sup>2</sup>), consisting of:  
1 punch 3 13 09 110 00 4 and 1 die 3 13 09 107 00 0

Part number	£ List Price excl. VAT
3 13 09 110 01 3	193.20

**Punches and dies in a set**  
up to 3.0 mm stainless steel plate (600 N/mm<sup>2</sup>), consisting of:  
1 punch 3 13 09 134 00 6 and 1 die 3 13 09 108 00 8

Part number	£ List Price excl. VAT
3 13 09 134 01 5	193.20



**Chips bag**

Part number	£ List Price excl. VAT
3 13 09 114 00 8	98.91

**Punch**  
up to 7.0 mm aluminium steel plate (250 N/mm<sup>2</sup>)  
up to 5.0 mm steel sheet (400 N/mm<sup>2</sup>)

Part number	£ List Price excl. VAT
3 13 09 110 00 4	88.88

**Punch**  
up to 3.0 mm stainless steel plate (600 N/mm<sup>2</sup>)

Part number	£ List Price excl. VAT
3 13 09 134 00 6	88.88

**Die**  
for steel sheet up to 5 mm thickness

Part number	£ List Price excl. VAT
3 13 09 107 00 0	109.05

**Die**  
up to 3.0 mm stainless steel plate (600 N/mm<sup>2</sup>)

Part number	£ List Price excl. VAT
3 13 09 108 00 8	109.05

**Die**  
up to 7.0 mm aluminium steel plate (250 N/mm<sup>2</sup>)  
up to 5.0 mm steel sheet (400 N/mm<sup>2</sup>)

Part number	£ List Price excl. VAT
3 13 09 109 00 2	106.99



## Tried and tested technology for perfect results: sawing and milling from FEIN.

High grade steel processing, building kitchens, metal processing and industry – FEIN jigsaws are designed perfectly for the high loads experienced when working with steel and stainless steel. As genuine specialist metal tools, FEIN jigsaws maintain a constant stroke and therefore constant cutting speed even under extreme load levels. The sturdy metal housing and resilient gears make these legendary endurance tools, often last decades. The FEIN range is supplemented by tools for pipe processing: jigsaws for pipes with a diameter of up to max. 440 mm, mainly for plant construction and community supply connections. FEIN also manufactures special pipe milling machines for pipes with a diameter of up to approx. 3 000 mm for plant and pipeline construction.



<b>Jigsaws</b>	<b>Page</b>	<b>86</b>
Optimum cutting speed with minimal wear.		
<b>Pipe Saws</b>	<b>Page</b>	<b>89</b>
Optimum cutting speed with minimal wear.		
<b>Construction cutter</b>	<b>Page</b>	<b>93</b>
Remove old windows with no dust or damage to the wall.		



	<b>ASte 638</b>	<b>ASt 638</b>	
	Metal jigsaws with continuously variable speed control and stainless steel base plate for unsurpassed precision, robustness and service life.	Metal jigsaws with unsurpassed precision, robustness and service life.	
<b>EAN 4014586...</b>			
<b>Page</b>	87	87	
<b>Technical features</b>	Input	450 W	350 W
	Strokes	1 050 - 2 600 1/min	3 350 1/min
	Stroke of blade	20 mm	20 mm
	Weight according to EPTA	2,30 kg	2,20 kg
	Max. cutting capacity		
	Stainless steel (V2A)	6 mm	3 mm
	Steel (St 37)	10 mm	8 mm
	Hard/soft wood and plywood	60 / 50 mm	50 / 40 mm
	Hard particle / fibre-glass materials	30 / 30 mm	25 / 20 mm
	Radius of smallest curve steel/woods and plastics	8 / 6 mm	8 / 6 mm

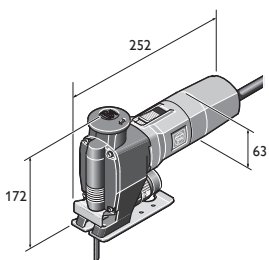

ASt 638  
ASte 638





Type	Part number	PC	£ List Price excl. VAT
<b>ASte 638</b>	<b>7 234 15</b>	<b>01</b>	<b>645.00</b>

**Price includes:**  
2 packs of saw blades, 1 anti-chipping protector, 1 Chip protection additional  
For accessories, see page 87



















Type	Part number	PC	£ List Price excl. VAT
<b>ASst 638</b>	<b>7 234 17</b>	<b>01</b>	<b>549.00</b>

















**Price includes:**  
2 packs of saw blades, 1 anti-chipping protector  
For accessories, see page 87

Jigsaws

Saw blades for metal and sandwich material

									Qualität/Quality	No. in pack pcs	Part number	£ List Price excl. VAT
	< 1,2		< 1,2				77	0,7	HSS	5	6 35 03 060 01 0	16.86
	< 1,2						100	0,7	HSS	5	6 35 03 076 01 0	15.91
	< 2,0	< 2,0	< 2,0	< 2,0	< 4,0		88	1,2	HSS	5	6 35 03 035 01 1	10.09
	< 2,0	< 2,0	< 2,0		< 4,0	< 70,0	120	1,2	HSS	5	6 35 03 077 01 4	20.63
	< 10,0	< 8,0	< 10,0	< 6,0	< 8,0		88	2,0	HSS	5	6 35 03 036 01 4	10.09
	< 10,0	< 8,0	< 10,0		< 30,0	< 120	180	2	BIM	5	6 35 03 114 01 0	28.41
	< 2,0	< 2,0	< 2,0	< 2,0	< 4,0		88	1,2	BIM	5	6 35 03 112 01 0	15.74
	< 10,0	< 8,0	< 10,0	< 6,0	< 8,0		88	2,0	BIM	5	6 35 03 113 01 0	15.74
	< 6,0	< 15,0					100	3,0	BIM	5	6 35 03 088 01 1	12.77

Saw blades for wood and other materials

							Qualität/Quality	No. in pack pcs	Part number	£ List Price excl. VAT	
			< 25,0	< 25,0	77	2	HCS	5	6 35 03 087 01 3	10.09	
			< 40,0	< 15,0	< 25,0	88	3,0	HCS	5	6 35 03 037 01 8	10.09
			< 50,0	< 30,0	< 50,0	88	4,0	HCS	5	6 35 03 038 01 6	10.09
			< 60,0	< 30,0	< 60,0	100	4,0	HCS	5	6 35 03 082 01 0	13.39
					77		HM	5	6 35 03 089 01 5	34.00	
	< 25,0		< 30,0		88	4,0	HSS	5	6 35 03 039 01 0	12.75	
	< 10,0				77			1	6 35 03 061 01 9	46.94	

**General accessories**



**Tool case**  
Plastic, inner dimensions: 470 x 275 x 116 mm

Part number	£ List Price excl. VAT
3 39 01 118 01 0	46.09



**Plastic box**  
Box insert with lockable lid for small parts and accessories, suitable for tool box 3 39 01 118 01 0, max 5 items/box.

Part number	£ List Price excl. VAT
3 39 01 119 00 0	4.54



**Cutting paste**  
Lubricating agents for working on sheet metals.

Part number	£ List Price excl. VAT
3 21 32 020 12 9	15.48

**Shoe plate**  
Extended, for sawing profiles and profiled insulation material. Length approx. 340 mm.

Part number	£ List Price excl. VAT
3 27 14 084 00 8	102.42



**Anti-chipping protector**  
Pack of 5

Part number	£ List Price excl. VAT
3 14 28 102 01 6	10.48



**Chipping protector**  
for ASt(e) 638

Part number	£ List Price excl. VAT
3 27 14 088 00 7	5.20



**Hose sleeve**  
for the connection of FEIN Electric Power Tools with dust extraction

Ø mm	Part number	£ List Price excl. VAT
32	3 05 17 028 00 7	2.83
27	3 05 17 029 00 1	3.45



**Connecting piece**  
Universal device to connect power tools and accessories with dust extraction to vacuum cleaner. Flexible rubber sleeve, length 70 mm, inner diameter 31.5 mm.

Part number	£ List Price excl. VAT
3 13 22 771 00 9	5.59



	<b>AStx 649-1</b>	<b>AStxe 649-1</b>	<b>STS 325 R</b>	
	Powerful hacksaw for pipes and profiled sections.	Powerful hacksaw for pipes and profiled sections with continuously variable speed adjustment.	Compressed air hacksaw for pipes and profiled sections.	
<b>EAN 4014586...</b>	... 858470		... 855639	
<b>Page</b>	90	90	90	
<b>Technical features</b>	Input	750 W	750 W	
	Strokes	350 1/min	100 - 350 1/min	330 1/min
	Stroke of blade	60 mm	60 mm	60 mm
	Operating pressure			6 bar
	Air consumption			1,45 m <sup>3</sup> /min
	Weight according to EPTA	6,10 kg	6,40 kg	7,20 kg
	Pipes up to Ø	440 * mm	400 * mm	440 * mm
	profiles up to W x H	290 x 550 mm	290 x 550 mm	290 x 500 mm

\* With chain extension.

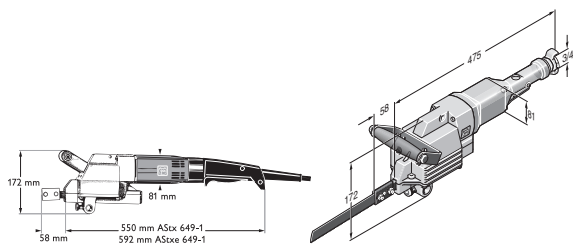

AStx 649-1  
AStxe 649-1

STS 325 R



Type	Part number	EAN	PC	£ List Price excl. VAT
<b>ASTx 649-1*</b>	<b>7 234 22 00 23 0</b>	<b>4014586858470</b>	<b>01</b>	<b>2,399.00</b>

**Price includes:**

2 saw blades, 1 additional handle, 1 set of keys

For accessories, see page 91

\* 230 V only



Type	Part number	PC	£ List Price excl. VAT
<b>ASTxe 649-1</b>	<b>7 234 23</b>	<b>01</b>	<b>2,548.00</b>

**Price includes:**

2 saw blades, 1 additional handle, 1 set of keys

For accessories, see page 91



Type	Part number	EAN	PC	£ List Price excl. VAT
<b>STS 325 R</b>	<b>7 534 08 00 00 0</b>	<b>4014586855639</b>	<b>01</b>	<b>3,126.00</b>

**Price includes:**

2 saw blades, 1 set of keys, 1 additional handle, 1 hose coupling

For accessories, see page 91



**Saw blades**

	Non-ferrous metals and steel 400 N/mm <sup>2</sup>	Steel more than 400 N/mm <sup>2</sup> and cast iron	Miscellaneous	Length	Tooth spacing	Thickness	Weight (net)	Material	Part number	£ List Price excl. VAT
				mm	mm	mm	kg			
	x	x	≤ Ø 80	200	1,0	1,5	0,06	HSS	6 35 03 067 00 6	10.01
	x	x	≤ Ø 80	200	1,6	1,5	0,06	HSS	6 35 03 066 00 2	9.65
	x	x	≤ Ø 170 <sup>1</sup>	300	1,6	1,5	0,06	HSS	6 35 03 063 00 7	10.67
	x	x	≤ Ø 260 <sup>1</sup>	400	1,6	1,5	0,125	HSS	6 35 03 064 00 5	16.77
	x	x	≤ Ø 350 <sup>2</sup>	500	1,8	2,0	0,18	HSS	6 35 03 072 00 2	27.20
	x	x	≤ Ø 440 <sup>2</sup>	600	1,8	2,0	0,21	HSS	6 35 03 073 00 6	41.50
	x	x		300	2,1	1,5	0,08	HSS	6 35 03 070 00 0	11.98
	x		*	530	2,1	1,5	0,170	HSS	6 35 03 069 00 8	21.79
	x (AL)		Plastic	200	3,2	1,5	0,06	HSS	6 35 03 065 00 9	7.86
	x (AL)		Plastic	400	3,2	1,5	0,125	HSS	6 35 03 068 00 4	16.77
			PE pipes, porous concrete	300	6,3	1,5	0,08		6 35 03 071 00 9	8.46
			PE pipes, porous concrete *	530	6,3	1,5	0,170		6 35 03 040 00 3	15.13

Sawing and cutting

**HD saw blades**

Special saw blades for cutting steel and stainless steel. HD saw blades are noted for their long service life and rapid sawing speed. Give them a try: it will pay off.

	Non-ferrous metals and steel 400 N/mm <sup>2</sup>	Steel more than 400 N/mm <sup>2</sup> and cast iron	Miscellaneous	Length	Tooth spacing	Thickness	Weight (net)	Material	Part number	£ List Price excl. VAT
				mm	mm	mm	kg			
	x	x	≤ Ø 170 <sup>1</sup>	300	1,6	2,0	0,08	HSS	6 35 03 093 00 4	21.59
	x	x	≤ Ø 350 <sup>2</sup>	500	1,8	2,0	0,18	HSS	6 35 03 099 00 5	39.79
	x	x	≤ Ø 325 *	530	2,1	1,6	0,17	HSS	6 35 03 100 00 6	31.08
	x	x	≤ Ø 260 <sup>1</sup>	400	2,1	2,0	0,175	HSS	6 35 03 094 00 2	28.86
	x	x	≤ Ø 260 <sup>1</sup>	400	3,2	2,0	0,175	HSS	6 35 03 095 00 6	28.86
	x	x	≤ Ø 440 <sup>2</sup>	600	1,8	2,0	0,21	HSS	6 35 03 098 00 1	48.68

**TD saw blades**

TD saw blades are suitable for cutting wet and dry pipes. They are noted for rapid sawing speed and for clean cuts.

	for ductile cast-iron pipes, also with cement mortar cladding and cast iron pipes	Pipes Ø (DN)	Length	Coating length	Thickness	Weight	Part number	£ List Price excl. VAT
		mm	mm	mm	mm	kg		
	x	80 - 150 <sup>3</sup>	320	260	2,2	0,110	6 35 03 096 01 8	190.83
	x	80 - 300 <sup>3</sup>	490	430	2,9	0,220	6 35 03 097 01 2	252.95

\* only with saw blade guide 9 06 06 002 00 9

<sup>1</sup> for use with the FEIN clamp and feed device 9 07 02 005 00 0 or clamping device 9 07 02 004 00 6

<sup>2</sup> only with chain extension up to Ø 440 mm, chain 3 02 31 003 00 3 and bolt 3 02 16 130 00 4 also required

<sup>3</sup> to be used with the FEIN clamp and feed device 9 07 02 005 00 0

**General accessories**



**Tool case**  
Metal

Width mm	Length mm	Height mm	Part number	£ List Price excl. VAT
240	690	160	3 39 01 022 01 4	54.75



**Cutting paste**  
Lubricating agents for working on sheet metals.

Part number	£ List Price excl. VAT
3 21 32 020 12 9	15.48



**FEIN clamp and feed device**  
(W x D x H) 280 x 285 x 395 mm, for pipes and circular material with an outside dia. of 80 mm to 400 mm

Part number	£ List Price excl. VAT
9 07 02 005 00 0	2,147.03

**Protective steel jaws**  
for avoiding damage to the surface of the pipe, 4 pieces required

Part number	£ List Price excl. VAT
3 13 27 064 00 8	54.88



**Cleaning block**  
Rhombus for cleaning the carbide tools and diamond-coated tools.

Part number	£ List Price excl. VAT
6 37 19 007 01 0	22.68



**Clamping fixture**  
for pipes from Ø 100 mm up to 325 mm, only with extension of the chain up to Ø 440 mm, chain 3 02 31 003 00 3 and bolt 3 02 16 130 00 4 necessary

Part number	£ List Price excl. VAT
9 07 02 004 00 6	375.28



**Clamping fixture**  
for profiles up to 290 mm width at max height 550 mm

Part number	£ List Price excl. VAT
9 07 02 003 00 8	302.53



**Saw blade guide**  
for pipes up to Ø 325 mm only with saw blade 530 mm length, guide to the centre of the pipe

Part number	£ List Price excl. VAT
9 06 06 002 00 9	303.80



**Support**  
for free hand working

Part number	£ List Price excl. VAT
3 27 14 062 02 3	225.41

**Splitter wedge**  
Prevents the jamming of the saw blade

Part number	£ List Price excl. VAT
6 33 05 006 00 8	10.98

**Accessory STS 325 R**

**Hose coupling**

Part number	£ List Price excl. VAT
4 11 40 004 00 7	29.21



		<b>MF 14-180</b>
		Extremely powerful and robust construction cutter for removing old windows.
<b>EAN 4014586...</b>		... 865744
<b>Page</b>		93
<b>Technical features</b>	Input	1 200 W
	Output	750 W
	Speed, no load	7 000 1/min
	Diamond wheel Ø	180 mm
	Cutting depth	0 - 50 mm
	Cable with plug	4 m
	Weight according to EPTA	4,10 kg

Sawing and cutting



Type	Part number	EAN	PC	£ List Price excl. VAT
<b>MF 14-180*</b>	<b>7 238 14 00 23 0</b>	<b>4014586865744</b>	<b>01</b>	<b>1,409.00</b>

**Price includes:**  
1 FEIN construction cutter MF 14-180, 1 diamond wheel, Ø 180 mm, 1 plastic carrying case  
For accessories, see page 93  
\* 230 V only

**Construction cutter**

**General accessories**



**Diamond wheel**  
Ø 180 mm, special retainer for MF 14-180.

<b>Part number</b>	<b>£ List Price excl. VAT</b>
6 35 02 146 01 1	119.77



**Connecting piece**  
Universal device to connect power tools and accessories with dust extraction to vacuum cleaner. Flexible rubber sleeve, length 70 mm, inner diameter 31.5 mm.

<b>Part number</b>	<b>£ List Price excl. VAT</b>
3 13 22 771 00 9	5.59





## Metal core drills - the most cost effective drilling experience.

Core drilling is an extremely efficient process: faster, quieter and more accurate than twist drilling. Since core drilling requires no predrilling or retooling, the time needed for the job can be cut by up to around 40 % – on site or in the workshop. The high-quality FEIN magnet core drill units (KBM) can be used with carbide core drills and are suited to many applications such as core drilling, spiral drilling, thread cutting, countersinking and reaming. The FEIN KBB range of magnet core drill units, on the other hand, are designed solely for efficient core drilling. The same applies to the FEIN core bits. High-quality carbides, HSS steels and sophisticated cutting geometries ensure the best cutting performances and very long service life. The world's first hand-guided metal drilling

system, the FEIN KBH 25, combines the benefits of powerful hand drills and carbide-tipped core drills in one. The new drilling technology and specially developed carbide core drill bit make possible flexible, comfortable and rapid work. Whether for steel, stainless steel or aluminium: we've got the right solution for every application, thanks to our extensive range of core bits. The FEIN core drilling system will revolutionise your work!

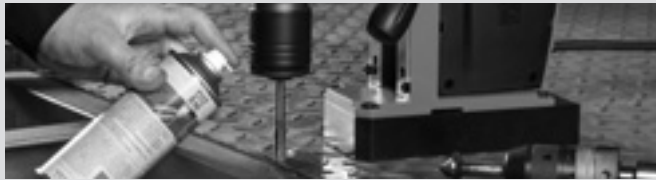

<b>Mobile</b>	<b>Page</b>	<b>96</b>
Flexible hand-guided metal core drilling system with work progress six times faster than twist drilling.		
<b>Economical</b>	<b>Page</b>	<b>100</b>
Economical magnetic core drills with basic functionality for drilling, which do not compromise on lifetime or performance.		
<b>Compact</b>	<b>Page</b>	<b>102</b>
Compact magnetic core drills with minimum dimensions for core drilling in tight and difficult-to-reach spots.		
<b>Universal</b>	<b>Page</b>	<b>108</b>
High-performance universal magnetic core drills with very high quality standards for universal applications.		
<b>Automatic</b>	<b>Page</b>	<b>121</b>
High-performance, fully automatic auto magnetic core drills for maximum efficiency and minimum physical strain.		



	<b>KBH 25 S</b>	<b>KBH 25-2 U</b>	
	Hand-guided single-speed metal core drilling system for rapid and flexible use of core drills.	Hand-guided 2-speed metal core drilling system for universal use of core drills and twist drills.	
<b>EAN 4014586...</b>			
<b>Page</b>	97	97	
<b>Technical features</b>	Drilling diameter in steel, core drill bit	25 mm	25 mm
	Hole diameter in stainless steel, core drill	25 mm	25 mm
	Drilling diameter in aluminium, core drill bit	30 mm	30 mm
	Drilling diameter in steel, hole saws		80 mm
	Input	1 200 W	1 200 W
	Output	680 W	680 W
	Speed, full load		
	Centre drilling	0 - 1 600* 1/min	0 - 1 600 1/min
	1st gear	0 - 520* 1/min	0 - 520 1/min
2nd gear		0 - 1 600 1/min	
Weight according to EPTA	3,30 kg	3,40 kg	

\*No manual changeover possible.

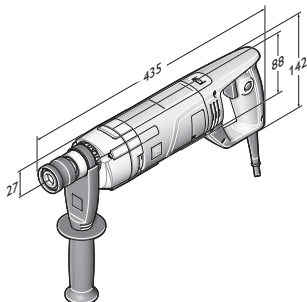

KBH 25 S  
KBH 25-2 U



Type	Part number	PC	£ List Price excl. VAT
<b>KBH 25 S</b>	<b>7 271 04 61</b>	<b>01</b>	<b>799.00</b>

**Price includes:**  
1 centring drill bit, 1 additional handle, 1 cutting spray, 1 plastic carrying case  
For accessories, see page 97



Type	Part number	PC	£ List Price excl. VAT
<b>KBH 25-2 U</b>	<b>7 271 03 61</b>	<b>01</b>	<b>847.00</b>

**Price includes:**  
1 centring drill bit, 1 quick-action chuck Ø 3-16 mm, 1 additional handle, 1 cutting spray, 1 plastic carrying case  
For accessories, see page 97

Mobile

Carbide core drill



**Carbide core drill bit with QuickIN PLUS holder**  
Outstanding cutting performance in all common metals.  
Metric dimensions, cutting depth 20 mm, drilling diameter in steel up to 25 mm, drilling diameter in aluminium up to 30 mm.

Bore Ø mm	Part number	£ List Price excl. VAT
14	6 31 30 014 01 0	48.53
15	6 31 30 015 01 0	48.53
16	6 31 30 016 01 0	48.53
17	6 31 30 017 01 0	48.53
18	6 31 30 018 01 0	48.53
19	6 31 30 019 01 0	48.53
20	6 31 30 020 01 0	48.53
21	6 31 30 021 01 0	48.53
22	6 31 30 022 01 0	48.53
23	6 31 30 023 01 0	48.53
24	6 31 30 024 01 0	50.53
25	6 31 30 025 01 0	50.53
26	6 31 30 026 01 0	50.53
27	6 31 30 027 01 0	49.21
28	6 31 30 028 01 0	49.21
29	6 31 30 029 01 0	52.49
30	6 31 30 030 01 0	53.91

TiAlN-coated carbide core drill



**Carbide core drill bit with TiAlN coating and QuickIN PLUS holder**  
Maximum service life thanks to TiAlN coating. Outstanding cutting performance in all common metals, 20% better work progress, reduced cutting and feed forces thanks to TiAlN coating.  
Metric dimensions, cutting depth 20 mm, drilling diameter in steel up to 25 mm, drilling diameter in aluminium up to 30 mm.

Bore Ø mm	Part number	£ List Price excl. VAT
14	6 31 30 114 01 0	61.84
15	6 31 30 115 01 0	61.84
16	6 31 30 116 01 0	61.84
17	6 31 30 117 01 0	61.84
18	6 31 30 118 01 0	65.23
19	6 31 30 119 01 0	65.23
20	6 31 30 120 01 0	65.23
21	6 31 30 121 01 0	65.23
22	6 31 30 122 01 0	65.23
23	6 31 30 123 01 0	65.23
24	6 31 30 124 01 0	69.30
25	6 31 30 125 01 0	69.30
26	6 31 30 126 01 0	67.47
27	6 31 30 127 01 0	67.47
28	6 31 30 128 01 0	67.47
29	6 31 30 129 01 0	67.47
30	6 31 30 130 01 0	67.47

**Carbide hole saws**



**Carbide hole saw with QuickIN PLUS holder**  
 Carbide cutting tips for optimum service life for efficient drilling in sheet metal plate up to 4.0 mm thick.  
 Metric dimensions, cutting depth 4 mm.

Bore Ø mm	Part number	£ List Price excl. VAT
14	6 31 31 014 01 0	37.69
15	6 31 31 015 01 0	36.74
16	6 31 31 016 01 0	37.69
17	6 31 31 017 01 0	36.74
18	6 31 31 018 01 0	36.74
19	6 31 31 019 01 0	36.74
20	6 31 31 020 01 0	42.44
21	6 31 31 021 01 0	41.35
22	6 31 31 022 01 0	41.35
23	6 31 31 023 01 0	41.35
24	6 31 31 024 01 0	42.44
25	6 31 31 025 01 0	41.35
26	6 31 31 026 01 0	41.35
27	6 31 31 027 01 0	41.35
28	6 31 31 028 01 0	42.44
29	6 31 31 029 01 0	44.50
30	6 31 31 030 01 0	44.50
31	6 31 31 031 01 0	47.90
32	6 31 31 032 01 0	49.19
33	6 31 31 033 01 0	47.90
34	6 31 31 034 01 0	51.58
35	6 31 31 035 01 0	51.58
36	6 31 31 036 01 0	56.58
37	6 31 31 037 01 0	56.58
38	6 31 31 038 01 0	58.07
39	6 31 31 039 01 0	56.58
40	6 31 31 040 01 0	56.58
41	6 31 31 041 01 0	56.58
42	6 31 31 042 01 0	56.58
43	6 31 31 043 01 0	62.07
44	6 31 31 044 01 0	63.74
45	6 31 31 045 01 0	62.07
46	6 31 31 046 01 0	62.07
47	6 31 31 047 01 0	62.07
48	6 31 31 048 01 0	66.28
49	6 31 31 049 01 0	66.28
50	6 31 31 050 01 0	66.28
51	6 31 31 051 01 0	66.28
52	6 31 31 052 01 0	66.28
53	6 31 31 053 01 0	68.25
54	6 31 31 054 01 0	70.06
55	6 31 31 055 01 0	70.86
56	6 31 31 056 01 0	77.07
57	6 31 31 057 01 0	83.29
58	6 31 31 058 01 0	89.51
59	6 31 31 059 01 0	96.96
60	6 31 31 060 01 0	104.43
65	6 31 31 065 01 0	106.90
68	6 31 31 068 01 0	110.65
70	6 31 31 070 01 0	115.62
75	6 31 31 075 01 0	118.10
80	6 31 31 080 01 0	123.07

**Carbide hole saws for pipes**



**Carbide hole saw for pipes with QuickIN PLUS holder**  
 Carbide cutting tips for optimum service life for use with pipe material and curved surfaces with wall thicknesses of up to 4 mm.  
 Metric dimensions, cutting depth 4 mm.

Bore Ø mm	Part number	£ List Price excl. VAT
21	6 31 31 421 01 0	47.83
22	6 31 31 422 01 0	47.83
23	6 31 31 423 01 0	46.59
24	6 31 31 424 01 0	47.83
25	6 31 31 425 01 0	46.59
26	6 31 31 426 01 0	46.59
27	6 31 31 427 01 0	46.59
28	6 31 31 428 01 0	47.83
29	6 31 31 429 01 0	49.86
30	6 31 31 430 01 0	49.86
31	6 31 31 431 01 0	56.30
32	6 31 31 432 01 0	57.82
33	6 31 31 433 01 0	56.30
34	6 31 31 434 01 0	59.60
35	6 31 31 435 01 0	59.60
36	6 31 31 436 01 0	66.81
37	6 31 31 437 01 0	66.81
38	6 31 31 438 01 0	68.58
39	6 31 31 439 01 0	66.81
40	6 31 31 440 01 0	66.81
41	6 31 31 441 01 0	75.99
42	6 31 31 442 01 0	75.99
43	6 31 31 443 01 0	75.99
44	6 31 31 444 01 0	75.99
45	6 31 31 445 01 0	75.99
46	6 31 31 446 01 0	82.54
47	6 31 31 447 01 0	82.54
48	6 31 31 448 01 0	82.54
49	6 31 31 449 01 0	82.54
50	6 31 31 450 01 0	82.54
51	6 31 31 451 01 0	85.19
52	6 31 31 452 01 0	85.19
53	6 31 31 453 01 0	85.19
54	6 31 31 454 01 0	87.47
55	6 31 31 455 01 0	87.02
56	6 31 31 456 01 0	89.51
57	6 31 31 457 01 0	93.23
58	6 31 31 458 01 0	101.94
59	6 31 31 459 01 0	106.90
60	6 31 31 460 01 0	111.88
65	6 31 31 465 01 0	121.83
68	6 31 31 468 01 0	129.28

**Centring drill bit**



Centring drill bit

No. in pack pcs	Part number	£ List Price excl. VAT
1	6 31 14 038 01 0	16.69
5	6 31 14 038 02 0	74.97

**Tapping**



**Collet chuck**  
with collets 6/7/9 mm

Part number	£ List Price excl. VAT
6 32 06 067 02 0	113.20



**Collets**  
for collet chucks and floating collet chucks and tapping adapters.  
M2 (DIN 352, DIN 371), M4 (DIN 357, DIN 376)

Ø mm	Square mm	Part number	£ List Price excl. VAT
2,8	2,1	6 32 06 077 00 1	26.03



**Collets**  
for collet chucks and floating collet chucks and tapping adapters.  
M3 (DIN 352, DIN 371), M5 (DIN 357, DIN 376)

Ø mm	Square mm	Part number	£ List Price excl. VAT
3,5	2,7	6 32 06 064 00 1	26.03



**Collets**  
for collet chucks and floating collet chucks and tapping adapters.  
M4 (DIN 352, DIN 371), M6 (DIN 357, DIN 376)

Ø mm	Square mm	Part number	£ List Price excl. VAT
4,5	3,4	6 32 06 065 00 5	26.03



**Collets**  
for collet chucks and floating collet chucks and tapping adapters.  
M5 (DIN 352, DIN 371), M6 (DIN 352), M7 (DIN 352),  
M8 (DIN 352, DIN 357, DIN 376)

Ø mm	Square mm	Part number	£ List Price excl. VAT
6	4,9	6 32 06 066 00 8	26.03



**Collets**  
for collet chucks and floating collet chucks and tapping adapters.  
M7 (DIN 371), M9 (DIN 352) M 10 (DIN 352, DIN 357,  
DIN 376)

Ø mm	Square mm	Part number	£ List Price excl. VAT
7	5,5	6 32 06 070 00 6	26.03



**Collets**  
for collet chucks and floating collet chucks and tapping adapters.  
M12 (DIN 357, DIN 371, DIN 376)

Ø mm	Square mm	Part number	£ List Price excl. VAT
9	7	6 32 06 075 00 4	26.03



**Collets**  
for collet chucks and floating collet chucks and tapping adapters.  
M8 (DIN 371), M11 (DIN 352)

Ø mm	Square mm	Part number	£ List Price excl. VAT
8	6,2	6 32 06 078 00 9	26.03



**Collets**  
for collet chucks and floating collet chucks and tapping adapters.  
M10 (DIN 371)

Ø mm	Square mm	Part number	£ List Price excl. VAT
10	8	6 32 06 079 00 3	25.29



**Jaw chuck**  
for tapping drill direct adaptor clamping range 2.8 - 9.0 mm,  
with key wrench

Part number	£ List Price excl. VAT
6 32 06 018 01 0	115.05

**Other accessories**



**Swarf cup**  
Prevents contact with hot swarf with sharp edges.

Part number	£ List Price excl. VAT
3 21 74 013 01 0	19.69



**Cutting spray**  
300 ml pump spray, for long tool life, optimum cutting  
performance and enhanced swarf flow.

Part number	£ List Price excl. VAT
3 21 32 031 00 0	16.08



**Cutting paste**  
Lubricating agents for working on sheet metals.

Part number	£ List Price excl. VAT
3 21 32 020 12 9	15.48



**Extension**  
For use on confined, deep or layered surfaces. QuickIN-PLUS  
holder, length 100 mm, including adapter for centring drill bit.

Part number	£ List Price excl. VAT
6 31 06 017 01 0	75.09



**QuickIN PLUS adapter on B16**

Part number	£ List Price excl. VAT
6 39 01 047 00 0	21.43



**QuickIN Plus adapter for 1/2"-20 UNF**

Part number	£ List Price excl. VAT
6 39 01 054 00 0	22.77



**Key-type drill chucks**  
Drill chuck holder B 16

Chuck opening mm	Weight kg	Part number	£ List Price excl. VAT
1,5-13	0,41	6 32 02 030 01 5	48.44



**Quick-action chucks**  
Drill chuck holder B 16  
R shaped tip with locking force safety device

Chuck opening mm	Weight kg	Part number	£ List Price excl. VAT
1-13	0,56	6 32 04 032 00 6	91.69



**Quick-action chucks**  
Single sheath metal SUPRA SKE quick clamping drill chuck with  
locking force safety device, drill chuck holder 1/2"-20 UNF

Chuck opening mm	Weight kg	Part number	£ List Price excl. VAT
3-16	0,56	6 32 05 038 01 0	107.43



**Quick-action chucks**  
SUPRA SKE single-sheath metal quick-clamping drill chuck with  
chucking force safety device, QuickIN Plus holder

Part number	£ List Price excl. VAT
6 39 01 054 01 0	117.28



		KBB 30	KBB 38	KBB 60
		Small and extremely lightweight single-speed economical magnetic core drill with basic functionality for core drilling on the construction site.	Compact and precise single-speed economical magnetic core drill with basic functionality for core drilling in the workshop and on the construction site.	High-performance 2-speed economical magnetic core drill with basic functionality for core drilling in the workshop up to a cutting depth of 75 mm.
<b>EAN 4014586...</b>				
<b>Page</b>		101	101	101
<b>Application</b>	Core drilling in metal with a Ø up to 30 mm	▲▲	▲▲	▲▲
	Core drilling in metal with a Ø up to 40 mm			▲▲
	Core drilling in metal with a Ø up to 60 mm			▲▲
	Working one-handed	▲▲	▲▲	▲▲
	Working overhead	▲▲	▲▲	▲
	Installation work	▲▲	▲▲	▲
	Workshop jobs	▲▲	▲▲	▲▲
<b>Technical features</b>	Carbide core drill bit max. Ø	30 mm	38 mm	60 mm
	HSS core drill max. Ø	30 mm	38 mm	60 mm
	Core drill, drilling depth max.	50 mm	50 mm	75 mm
	Input	750 W	1 050 W	1 400 W
	Output	430 W	530 W	770 W
	Speed, no load	740 1/min	480 1/min	
	1st gear			330 1/min
	2nd gear			660 1/min
	Speed, full load	430 1/min	330 1/min	
	1st gear			180 1/min
	2nd gear			340 1/min
	Core drill holder	3/4" Weldon	3/4" Weldon	3/4" Weldon
	Stroke	65 mm	65 mm	92 mm
	Magnetic holding power	9 000 N	9 000 N	11 000 N
	Magnetic foot dimensions	178 x 95 mm	178 x 95 mm	191 x 102 mm
Cable with plug	3,8 m	3,8 m	3,8 m	
Weight according to EPTA	10,50 kg	12,90 kg	23,90 kg	

▲ suitability    ▲▲ optimal suitability

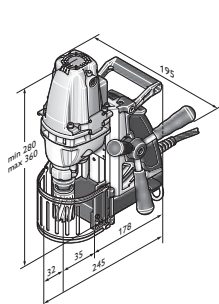

KBB 30

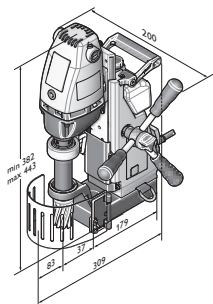

KBB 38

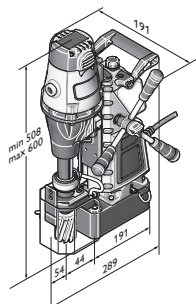

KBB 60



Type	Part number	PC	£ List Price excl. VAT
<b>KBB 30</b>	<b>7 272 01 61</b>	<b>01</b>	<b>920.00</b>

**Price includes:**

1 coolant tank, 1 lashing strap, 1 swarf hook, 2 centering pins, 1 contact guard, 1 socket head wrench 5 mm, 1 case

For accessories, see page 103



Type	Part number	PC	£ List Price excl. VAT
<b>KBB 38</b>	<b>7 272 02 61</b>	<b>01</b>	<b>1,071.00</b>

**Price includes:**

1 coolant tank, 1 lashing strap, 1 swarf hook, 2 centering pins, 1 contact guard, 1 socket head wrench 5 mm, 1 carry handle, 1 case

For accessories, see page 103



Type	Part number	PC	£ List Price excl. VAT
<b>KBB 60</b>	<b>7 272 04 61</b>	<b>01</b>	<b>2,083.00</b>

**Price includes:**

1 coolant tank, 1 lashing strap, 1 swarf hook, 2 centering pins, 1 contact guard, 1 socket head wrench 5 mm, 1 carry handle, 1 case

For accessories, see page 103

Metal  
core drilling



	KBC 35	KBB 40	
	Extremely small and light single-speed compact magnetic core drill with right-angle drive and minimum dimensions for use in tight spaces in the workshop and on the construction site.	Extremely small single-speed compact magnetic core drill with fixed drill motor for core drilling in tight spaces in the workshop and on the construction site.	
<b>EAN 4014586...</b>			
<b>Page</b>	103	103	
<b>Application</b>	Core drilling in metal with a Ø up to 35 mm	▲▲	▲▲
	Core drilling in metal with a Ø up to 40 mm		▲▲
	Working one-handed	▲▲	▲▲
	Working overhead	▲▲	▲▲
	Installation work	▲▲	▲▲
	Workshop jobs	▲▲	▲▲
<b>Technical features</b>	Input	1 100 W	1 100 W
	Output	550 W	610 W
	Speed, no load		450 1/min
	Speed, full load	130 - 520 1/min	280 1/min
	Carbide core drill bit max. Ø	35 mm	40 mm
	HSS core drill max. Ø	35 mm	40 mm
	Core drill, drilling depth max.	35 mm	50 mm
	Core drill holder	3/4" Weldon	3/4" Weldon
	Stroke	46 mm	65 mm
	Height	169 mm	305 mm
	Magnetic holding power	10 000 N	9 000 N
	Magnetic foot dimensions	175 x 80 mm	165 x 102 mm
Cable with plug	4 m	3,8 m	
Weight according to EPTA	7,50 kg	12,80 kg	

▲▲ optimal suitability

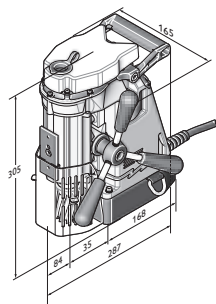

KBB 40





Type	Part number	PC	£ List Price excl. VAT
<b>KBC 35</b>	<b>7 272 15 61</b>	<b>01</b>	<b>1,299.00</b>

**Price includes:**

1 x 3/8" ratchet, 1 x 3/8" socket wrench extension, 1 x coolant pump, 1 lashing strap, 1 swarf hook, 1 centering pin, 1 contact guard, 1 additional handle, 2 x 5 and 8 mm hexagon socket wrench, 2 x 5 and 8 mm hexagon socket wrench with T-handle, 1 case

For accessories, see page 103



Type	Part number	PC	£ List Price excl. VAT
<b>KBB 40</b>	<b>7 272 03 61</b>	<b>01</b>	<b>1,434.00</b>

**Price includes:**

1 coolant tank, 1 lashing strap, 1 swarf hook, 2 centering pins, 1 contact guard, 1 socket head wrench 5 mm, 1 case

For accessories, see page 103

**Economical / Compact**

**Best of core drilling HSS accessory set**



**Best of core bits 3/4" Weldon**

Industrial standard. Metric dimensions, cutting depth 25 mm. Set version, consisting of 4 core bits, 2x 14 mm diameter, 2x 18 mm diameter, (cutting depth 25 mm) and 1 centring pin (80 mm) in plastic case.

Part number	£ List Price excl. VAT
6 31 34 999 06 2	95.71

**Best of core drilling carbide accessory set**



**Best of core bits 3/4" Weldon**

Very long service life and outstanding cutting performance. Metric dimensions, cutting depth 35 mm. Set version, consisting of 6 core bits with diameters of 12, 14, 16, 18, 20 and 22 mm (cutting depth 35 mm) and 2 centring pins (105 mm) in plastic case.

Part number	£ List Price excl. VAT
6 31 27 714 02 0	253.77



**Best of core bits 3/4" Weldon**

Industrial standard. Metric dimensions, cutting depth 50 mm. Set version, consisting of 4 core bits, 2x 14 mm diameter, 2x 18 mm diameter, (cutting depth 50 mm) and 1 centring pin (105 mm) in plastic case.

Part number	£ List Price excl. VAT
6 31 34 999 06 4	126.40

**HSS core drill**



**HSS Nova 25 core bit with 3/4" Weldon holder**

Industrial standard. Metric dimensions, cutting depth 25 mm.

Bore Ø mm	Part number	£ List Price excl. VAT
12	6 31 34 120 05 1	20.93
13	6 31 34 130 05 1	19.33
14	6 31 34 140 05 1	20.93
15	6 31 34 150 05 1	19.33
16	6 31 34 160 05 1	20.93
17	6 31 34 170 05 1	22.84
18	6 31 34 180 05 1	22.84
19	6 31 34 190 05 1	21.06
20	6 31 34 200 05 1	26.64



**Best of core bits 3/4" Weldon**

Industrial standard. Metric dimensions, cutting depth 25 mm. Set version, consisting of 6 core bits with diameters of 12, 14, 16, 18, 20 and 22 mm (cutting depth 25 mm) and 2 centring pins (80 mm) in plastic case.

Part number	£ List Price excl. VAT
6 31 34 999 06 1	151.91



**Best of core bits 3/4" Weldon**

Industrial standard. Metric dimensions, cutting depth 50 mm. Set version, consisting of 6 core bits with diameters of 12, 14, 16, 18, 20 and 22 mm (cutting depth 50 mm) and 2 centring pins (105 mm) in plastic case.

Part number	£ List Price excl. VAT
6 31 34 999 06 3	190.16

Metal  
core drilling

21	6 31 34 210 05 1	26.64
22	6 31 34 220 05 1	26.64
23	6 31 34 230 05 1	28.15
24	6 31 34 240 05 1	30.44
25	6 31 34 250 05 1	30.44
26	6 31 34 260 05 1	35.53
27	6 31 34 270 05 1	32.82
28	6 31 34 280 05 1	38.03
29	6 31 34 290 05 1	35.14
30	6 31 34 300 05 1	40.57
31	6 31 34 310 05 1	37.48
32	6 31 34 320 05 1	46.92
33	6 31 34 330 05 1	43.34
34	6 31 34 340 05 1	49.18
35	6 31 34 350 05 1	49.18
36	6 31 34 360 05 1	51.84
37	6 31 34 370 05 1	60.49
38	6 31 34 380 05 1	57.36
39	6 31 34 390 05 1	60.49
40	6 31 34 400 05 1	67.91
41	6 31 34 410 05 1	67.91
42	6 31 34 420 05 1	74.09
43	6 31 34 430 05 1	74.09
44	6 31 34 440 05 1	77.79
45	6 31 34 450 05 1	73.79
46	6 31 34 460 05 1	88.91
47	6 31 34 470 05 1	88.91
48	6 31 34 480 05 1	92.60
49	6 31 34 490 05 1	92.60
50	6 31 34 500 05 1	95.12
51	6 31 34 510 05 1	98.77
52	6 31 34 520 05 1	98.77
53	6 31 34 530 05 1	104.96
54	6 31 34 540 05 1	104.96
55	6 31 34 550 05 1	114.83
56	6 31 34 560 05 1	130.88
57	6 31 34 570 05 1	130.88
58	6 31 34 580 05 1	140.75
59	6 31 34 590 05 1	140.75
60	6 31 34 600 05 1	144.54

31	6 31 34 310 05 2	55.50
32	6 31 34 320 05 2	55.50
33	6 31 34 330 05 2	61.67
34	6 31 34 340 05 2	61.67
35	6 31 34 350 05 2	61.67
36	6 31 34 360 05 2	70.26
37	6 31 34 370 05 2	70.26
38	6 31 34 380 05 2	76.08
39	6 31 34 390 05 2	80.12
40	6 31 34 400 05 2	80.12
41	6 31 34 410 05 2	86.29
42	6 31 34 420 05 2	93.70
43	6 31 34 430 05 2	93.70
44	6 31 34 440 05 2	93.70
45	6 31 34 450 05 2	98.61
46	6 31 34 460 05 2	108.48
47	6 31 34 470 05 2	108.48
48	6 31 34 480 05 2	113.40
49	6 31 34 490 05 2	113.40
50	6 31 34 500 05 2	117.12
51	6 31 34 510 05 2	136.47
52	6 31 34 520 05 2	136.47
53	6 31 34 530 05 2	136.47
54	6 31 34 540 05 2	142.97
55	6 31 34 550 05 2	142.97
56	6 31 34 560 05 2	149.45
57	6 31 34 570 05 2	149.45
58	6 31 34 580 05 2	159.86
59	6 31 34 590 05 2	159.86
60	6 31 34 600 05 2	159.86



**HSS Nova 50 core bit with 3/4" Weldon holder**  
Industrial standard. Metric dimensions, cutting depth 50 mm.

Bore Ø mm	Part number	£ List Price excl. VAT
12	6 31 34 120 05 2	29.34
13	6 31 34 130 05 2	27.10
14	6 31 34 140 05 2	29.34
15	6 31 34 150 05 2	27.10
16	6 31 34 160 05 2	29.34
17	6 31 34 170 05 2	29.58
18	6 31 34 180 05 2	32.02
19	6 31 34 190 05 2	29.58
20	6 31 34 200 05 2	37.36
21	6 31 34 210 05 2	34.52
22	6 31 34 220 05 2	37.36
23	6 31 34 230 05 2	34.52
24	6 31 34 240 05 2	40.07
25	6 31 34 250 05 2	41.92
26	6 31 34 260 05 2	45.39
27	6 31 34 270 05 2	41.92
28	6 31 34 280 05 2	53.37
29	6 31 34 290 05 2	49.27
30	6 31 34 300 05 2	53.37



**HSS Nova 75 core bit with 3/4" Weldon holder**  
Industrial standard. Metric dimensions, cutting depth 75 mm.

Bore Ø mm	Part number	£ List Price excl. VAT
19	6 31 34 190 05 3	68.74
20	6 31 34 200 05 3	68.74
21	6 31 34 210 05 3	72.29
22	6 31 34 220 05 3	74.21
23	6 31 34 230 05 3	72.29
24	6 31 34 240 05 3	74.21
25	6 31 34 250 05 3	84.34
26	6 31 34 260 05 3	86.61
27	6 31 34 270 05 3	84.34
28	6 31 34 280 05 3	96.25
29	6 31 34 290 05 3	93.72
30	6 31 34 300 05 3	111.38
32	6 31 34 320 05 3	111.38
35	6 31 34 350 05 3	116.46
36	6 31 34 360 05 3	129.21
40	6 31 34 400 05 3	158.07
45	6 31 34 450 05 3	160.64
50	6 31 34 500 05 3	180.72
60	6 31 34 600 05 3	226.81



**HSS DURA 25 core bit with 3/4" Weldon holder**

TiN surface coating for outstanding service lives and the best glide properties.  
Metric dimensions, cutting depth 25 mm.



**HSS DURA 50 core bit with 3/4" Weldon holder**

TiN surface coating for outstanding service lives and the best glide properties.  
Metric dimensions, cutting depth 50 mm.

Bore Ø mm	Part number	£ List Price excl. VAT
12	6 31 34 120 07 5	30.02
13	6 31 34 130 07 5	30.02
14	6 31 34 140 07 5	30.82
15	6 31 34 150 07 5	30.02
16	6 31 34 160 07 5	30.82
17	6 31 34 170 07 5	32.76
18	6 31 34 180 07 5	31.07
19	6 31 34 190 07 5	32.76
20	6 31 34 200 07 5	36.84
21	6 31 34 210 07 5	36.84
22	6 31 34 220 07 5	34.92
23	6 31 34 230 07 5	45.03
24	6 31 34 240 07 5	45.03
25	6 31 34 250 07 5	45.03
26	6 31 34 260 07 5	50.45
27	6 31 34 270 07 5	49.13
28	6 31 34 280 07 5	53.21
29	6 31 34 290 07 5	53.21
30	6 31 34 300 07 5	58.67
31	6 31 34 310 07 5	58.67
32	6 31 34 320 07 5	66.88
33	6 31 34 330 07 5	66.88
34	6 31 34 340 07 5	69.89
35	6 31 34 350 07 5	73.69
36	6 31 34 360 07 5	73.69
37	6 31 34 370 07 5	83.25
38	6 31 34 380 07 5	83.25
39	6 31 34 390 07 5	83.25
40	6 31 34 400 07 5	92.78
41	6 31 34 410 07 5	92.78
42	6 31 34 420 07 5	100.99
43	6 31 34 430 07 5	100.99
44	6 31 34 440 07 5	107.79
45	6 31 34 450 07 5	107.79
46	6 31 34 460 07 5	120.08
47	6 31 34 470 07 5	120.08
48	6 31 34 480 07 5	131.01
49	6 31 34 490 07 5	131.01
50	6 31 34 500 07 5	134.54
51	6 31 34 510 07 5	139.19
52	6 31 34 520 07 5	139.19
53	6 31 34 530 07 5	146.02
54	6 31 34 540 07 5	146.02
55	6 31 34 550 07 5	150.12
56	6 31 34 560 07 5	156.94
57	6 31 34 570 07 5	156.94
58	6 31 34 580 07 5	170.59
59	6 31 34 590 07 5	170.59
60	6 31 34 600 07 5	170.59

Bore Ø mm	Part number	£ List Price excl. VAT
12	6 31 34 120 07 6	36.24
13	6 31 34 130 07 6	36.24
14	6 31 34 140 07 6	39.25
15	6 31 34 150 07 6	36.24
16	6 31 34 160 07 6	36.24
17	6 31 34 170 07 6	38.82
18	6 31 34 180 07 6	42.04
19	6 31 34 190 07 6	38.82
20	6 31 34 200 07 6	47.62
21	6 31 34 210 07 6	44.02
22	6 31 34 220 07 6	47.62
23	6 31 34 230 07 6	51.80
24	6 31 34 240 07 6	51.80
25	6 31 34 250 07 6	51.80
26	6 31 34 260 07 6	58.26
27	6 31 34 270 07 6	58.26
28	6 31 34 280 07 6	63.47
29	6 31 34 290 07 6	63.47
30	6 31 34 300 07 6	69.89
31	6 31 34 310 07 6	69.89
32	6 31 34 320 07 6	78.95
33	6 31 34 330 07 6	85.48
34	6 31 34 340 07 6	88.02
35	6 31 34 350 07 6	88.02
36	6 31 34 360 07 6	88.02
37	6 31 34 370 07 6	98.39
38	6 31 34 380 07 6	98.39
39	6 31 34 390 07 6	98.39
40	6 31 34 400 07 6	110.03
41	6 31 34 410 07 6	110.03
42	6 31 34 420 07 6	120.38
43	6 31 34 430 07 6	120.38
44	6 31 34 440 07 6	129.47
45	6 31 34 450 07 6	129.47
46	6 31 34 460 07 6	144.98
47	6 31 34 470 07 6	144.98
48	6 31 34 480 07 6	155.32
49	6 31 34 490 07 6	155.32
50	6 31 34 500 07 6	155.32
51	6 31 34 510 07 6	174.66
52	6 31 34 520 07 6	174.66
53	6 31 34 530 07 6	184.21
54	6 31 34 540 07 6	184.21
55	6 31 34 550 07 6	188.31
56	6 31 34 560 07 6	196.50
57	6 31 34 570 07 6	196.50
58	6 31 34 580 07 6	212.89
59	6 31 34 590 07 6	212.89
60	6 31 34 600 07 6	212.89

**Carbide core drill**



**TCT Ultra 35 core bit with 3/4" Weldon holder**  
 Very long service life and outstanding cutting performance.  
 Metric dimensions, cutting depth 35 mm.

Bore Ø mm	Part number	£ List Price excl. VAT
12	6 31 27 714 01 0	48.43
13	6 31 27 715 01 0	48.43
14	6 31 27 716 01 0	48.39
15	6 31 27 717 01 0	48.43
16	6 31 27 718 01 0	48.43
17	6 31 27 719 01 0	48.43
18	6 31 27 720 01 0	48.39
19	6 31 27 721 01 0	48.43
20	6 31 27 722 01 0	48.43
21	6 31 27 723 01 0	48.43
22	6 31 27 724 01 0	48.43
23	6 31 27 725 01 0	48.43
24	6 31 27 726 01 0	48.43
25	6 31 27 727 01 0	48.43
26	6 31 27 728 01 0	48.43
27	6 31 27 729 01 0	48.43
28	6 31 27 730 01 0	48.43
29	6 31 27 731 01 0	55.72
30	6 31 27 732 01 0	55.72
31	6 31 27 733 01 0	55.72
32	6 31 27 734 01 0	55.72
33	6 31 27 735 01 0	55.72
34	6 31 27 736 01 0	55.72
35	6 31 27 737 01 0	55.72
36	6 31 27 738 01 0	67.99
37	6 31 27 739 01 0	67.99
38	6 31 27 740 01 0	67.99
39	6 31 27 741 01 0	67.99
40	6 31 27 742 01 0	67.99
41	6 31 27 743 01 0	80.36
42	6 31 27 744 01 0	80.36
43	6 31 27 745 01 0	80.36
44	6 31 27 746 01 0	80.36
45	6 31 27 747 01 0	80.36
46	6 31 27 748 01 0	89.65
47	6 31 27 749 01 0	89.65
48	6 31 27 750 01 0	89.65
49	6 31 27 751 01 0	89.65
50	6 31 27 752 01 0	89.65
51	6 31 27 753 01 0	99.05
52	6 31 27 754 01 0	99.05
53	6 31 27 755 01 0	99.05
54	6 31 27 756 01 0	99.05
55	6 31 27 757 01 0	99.05
56	6 31 27 758 01 0	103.32
57	6 31 27 759 01 0	103.32
58	6 31 27 760 01 0	103.32
59	6 31 27 761 01 0	103.32
60	6 31 27 762 01 0	106.03

**Centering pins**



**Centering pins**

L mm	Part number	£ List Price excl. VAT
80	3 02 17 359 00 0	15.28
82	6 31 34 998 30 0	15.13
100	3 02 17 358 00 0	15.28
125	3 02 17 333 00 3	15.74

**Adapter/drill chuck**



**Adapter with 3/4" Weldon fitting**  
 1/4" hexagonal output in accordance with  
 DIN 3126/ISO 1173 – C 6.3

Part number	£ List Price excl. VAT
6 32 06 148 01 0	22.05



**Adapter with 3/4" Weldon fitting**  
 6 mm round shank output for M5-M8 in accordance with  
 DIN 352/ISO 13

Ø mm	Square mm	Part number	£ List Price excl. VAT
6	4,9	6 32 06 146 01 0	22.05



**Adapter with 3/4" Weldon fitting**  
 7 mm round shank output for M10 in accordance with  
 DIN 352/ISO 13

Ø mm	Square mm	Part number	£ List Price excl. VAT
7	5,5	6 32 06 147 01 0	22.05



**Adapter with 3/4" Weldon fitting**  
 9 mm round shank output for M12 in accordance with  
 DIN 352/ISO 13

Ø mm	Square mm	Part number	£ List Price excl. VAT
9	7	6 32 06 149 01 0	22.05



**HSS twist drill with 3/4" Weldon fitting**  
 Cutting depth 35 mm

Bore Ø mm	Part number	£ List Price excl. VAT
5	6 31 11 036 01 0	19.73
6	6 31 11 018 01 0	19.73
6,8	6 31 11 034 01 0	19.73
7	6 31 11 019 01 0	19.73
8	6 31 11 020 01 0	19.73
8,5	6 31 11 035 01 0	20.89
9	6 31 11 021 01 0	20.89
10	6 31 11 022 01 0	20.89
10,2	6 31 11 037 01 0	23.79
11	6 31 11 023 01 0	23.79
12	6 31 11 024 01 0	23.79
13	6 31 11 025 01 0	25.53
14	6 31 11 026 01 0	25.53
15	6 31 11 027 01 0	29.01
16	6 31 11 028 01 0	29.01



**HSS twist drill set with 3/4" Weldon fitting**  
 Comprising 6 HSS twist drills (diameters of 6, 8, 10, 12, 14 and  
 16 mm) in a handy plastic storage box.  
 Cutting depth 35 mm

Part number	£ List Price excl. VAT
6 31 11 018 02 0	150.86

**Tapping**



**HSS 90° countersink bit**  
 With 1/4" hexagon in accordance with  
 DIN 3126/ISO 1173 – C 6.3

Ø mm	Part number	£ List Price excl. VAT
16,5	6 31 11 038 01 0	18.57



**HSS 90° countersink bit with adapter with 3/4" Weldon fitting**

Ø mm	Part number	£ List Price excl. VAT
16,5	6 31 11 038 02 0	40.62



**Tapping drill for through holes**  
Short version in accordance with DIN 352/ISO 13.

Thread	L mm	Ø mm	Square mm	Part number	£ List Price excl. VAT
M 6	56	6	4,9	6 31 10 019 01 0	15.09
M 8	63	6	4,9	6 31 10 020 01 0	17.41
M 10	70	7	5,5	6 31 10 021 01 0	20.89
M 12	75	9	7	6 31 10 022 01 0	23.21



**Tapping drill for through holes with adapter with 3/4\" Weldon fitting**  
Short version in accordance with DIN 352/ISO 13.

Thread	Part number	£ List Price excl. VAT
M 6	6 31 10 019 03 0	37.13
M 8	6 31 10 020 03 0	39.45
M 10	6 31 10 021 03 0	42.94
M 12	6 31 10 022 03 0	45.26



**Tapping drill set for through holes**  
Comprising 1 x M6 threading drill in accordance with DIN 352/ISO 13 with 3/4\" Weldon adapter, 1 x HSS twist drill, 5 mm in diameter, with 3/4\" Weldon fitting and 1 x HSS 90° countersink bit, 16.5 mm in diameter, with 3/4\" Weldon adapter and 1 x hexagon socket wrench in a handy plastic storage box.

Thread	Part number	£ List Price excl. VAT
M 6	6 31 10 019 02 0	110.24



**Tapping drill set for through holes**  
Comprising 1 x M8 threading drill in accordance with DIN 352/ISO 13 with 3/4\" Weldon adapter, 1 x HSS twist drill, 6.8 mm in diameter, with 3/4\" Weldon fitting and 1 x HSS 90° countersink bit, 16.5 mm in diameter, with 3/4\" Weldon adapter and 1 x hexagon socket wrench in a handy plastic storage box.

Thread	Part number	£ List Price excl. VAT
M 8	6 31 10 020 02 0	110.24



**Tapping drill set for through holes**  
Comprising 1 x M10 threading drill in accordance with DIN 352/ISO 13 with 3/4\" Weldon adapter, 1 x HSS twist drill, 8.5 mm in diameter, with 3/4\" Weldon fitting and 1 x HSS 90° countersink bit, 16.5 mm in diameter, with 3/4\" Weldon adapter and 1 x hexagon socket wrench in a handy plastic storage box.

Thread	Part number	£ List Price excl. VAT
M 10	6 31 10 021 02 0	114.88



**Tapping drill set for through holes**  
Comprising 1 x M12 threading drill in accordance with DIN 352/ISO 13 with 3/4\" Weldon adapter, 1 x HSS twist drill, 10.2 mm in diameter, with 3/4\" Weldon fitting and 1 x HSS 90° countersink bit, 16.5 mm in diameter, with 3/4\" Weldon adapter and 1 x hexagon socket wrench in a handy plastic storage box.

Thread	Part number	£ List Price excl. VAT
M 12	6 31 10 022 02 0	114.88

**Clamping fixtures**



**Vacuum plate**  
for anti-magnetic materials and structured bases (corrugated sheet, stud plate etc.)  
Vacuum plate 396 x 200 x 95 mm

Part number	£ List Price excl. VAT
9 26 02 057 01 7	544.10



**Vacuum pump**  
Suction rate 0,015 m³/min, -0,8 bar, 92 W, weight 2,5 kg including suction hose

Part number	£ List Price excl. VAT
9 26 01 022 01 3	571.86

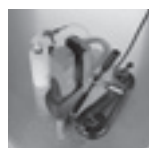

**Suction plate**  
for anti-magnetic materials, 250 x 330 x 110 mm

Part number	£ List Price excl. VAT
9 26 02 054 01 6	523.63



**Pipe drilling device**  
incl. clamping strap, for positioning bores on pipes with pipe Ø of 60 to 300 mm, 220 x 130 mm.

Part number	£ List Price excl. VAT
9 26 02 055 01 0	291.04

**Cooling**



**Pump**  
Capacity approx. 450 ml. Suited to FEIN core drilling units KBM 32 Q, KBM 50 QX, KBM 52 U, KBM 65 Q, KBM 65 QF.

Part number	£ List Price excl. VAT
3 21 32 022 00 7	10.98

**Replacement hose**  
for hand pump 3 21 32 022 00 7.

Part number	£ List Price excl. VAT
3 14 14 054 00 8	3.56



**Cutting spray**  
300 ml pump spray, for long tool life, optimum cutting performance and enhanced swarf flow.

Part number	£ List Price excl. VAT
3 21 32 031 00 0	16.08



**Cutting paste**  
Lubricating agents for working on sheet metals.

Part number	£ List Price excl. VAT
3 21 32 020 12 9	15.48

**Other accessories**



**Magbrush**  
Practical tool with high magnetic force for quick and easy collection of magnetic metal swarf.

Part number	£ List Price excl. VAT
6 42 01 005 01 0	49.78

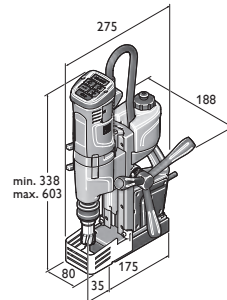

KBU 35 QW

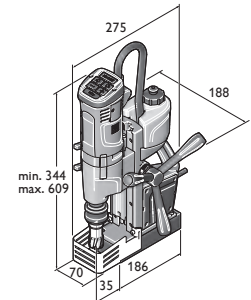

KBU 35-2 QW

	AKBU 35 PMQW	AKBU 35 PMQW Select	KBU 35 QW	KBU 35-2 QW	
	Small and powerful single-speed cordless universal magnetic core drill with forward/reverse running, MT2 tool mounting, permanent magnet and maximum functionality for mobile working on the construction site.		Small and powerful single-speed universal magnetic core drill with clockwise/anti-clockwise operation and maximum functionality for flexible working on the construction site.	Small and powerful 2-speed universal magnetic core drill with clockwise/anti-clockwise operation and high speed for efficient twist drilling on the construction site.	
<b>EAN 4014586...</b>	... 888200	... 889122			
<b>Page</b>	110	110	110	110	
<b>Application</b>	Core drilling in metal with a Ø up to 35 mm	▲▲	▲▲	▲▲	
	Core drilling in metal with a Ø up to 50 mm			▲▲	
	Core drilling in metal with a Ø up to 65 mm				
	Core drilling in metal with a Ø up to 80 mm				
	Twist drills with drill chuck (DIN 338)	▲	▲	▲	▲▲
	Twist drills with MK fitting (DIN 345)	▲▲	▲▲		
	Tapping	▲▲	▲▲	▲▲	▲▲
	Countersinking	▲▲	▲▲	▲▲	▲▲
	Reaming	▲▲	▲▲	▲▲	▲▲
	Working one-handed	▲▲	▲▲	▲▲	▲▲
	Working overhead	▲▲	▲▲	▲▲	▲▲
	Installation work	▲▲	▲▲	▲▲	▲▲
Workshop jobs	▲▲	▲▲	▲▲	▲▲	
<b>Equipment</b>	Electronic magnetic holding force				
	Magnetic holding force display	●	●	●	
	Reversible rotation	●	●	●	
	Variable speed control	●	●	●	
	Memory function	●	●	●	
	Speed-controlled electronics (tacho)	●	●	●	
Torque slipping clutch					
<b>Technical features</b>	Input			1 100 W	
	Output			550 W	
	Battery voltage	18 V	18 V		
	Battery capacity	5,2 Ah			
	Battery compatibility	Li-ion/ HighPower Li-ion**	Li-ion/ HighPower Li-ion**		
	Battery interface	18 V	18 V		
	Speed, full load	130 - 520 1/min	130 - 520 1/min	130 - 520 1/min	
	1st gear				130 - 520 1/min
	2nd gear				400 - 1 600 1/min
	3rd gear				
	Carbide core drill bit max. Ø	35 mm	35 mm	35 mm	35 mm
	HSS core drill max. Ø	35 mm	35 mm	35 mm	35 mm
	Core drill, drilling depth max.	50(75)* mm	50(75)* mm	50 mm	50 mm
	Twist drill max. Ø	18 mm	18 mm	16 mm	16 mm
	Tapping	M 14	M 14	M 14	M 14
	Countersinking max. Ø	31 mm	31 mm	31 mm	31 mm
	Reaming max. Ø	18 mm	18 mm	16 mm	16 mm
	Core drill holder	3/4" Weldon	3/4" Weldon	3/4" Weldon	3/4" Weldon
	Tool Holder	MT 2	MT 2		
	Stroke	135 mm	135 mm	135 mm	135 mm
	Total stroke range	260 mm	260 mm	260 mm	260 mm
Adjustment range for drill jigs					
Swivel range for drill jigs					
Magnetic holding power	9 000 N	9 000 N	10 000 N	9 500 N	
Magnetic foot dimensions	195 x 70 mm	195 x 70 mm	175 x 80 mm	186 x 70 mm	
Cable with plug			4 m	4 m	
Weight according to EPTA			10,60 kg	11,00 kg	
Weight with battery	12,80 kg				
Weight without storage battery	12,10 kg	12,10 kg			

▲ suitability    ▲▲ optimal suitability    ● included    \* Also available with accessories.    \*\* Maximum performance with FEIN HighPower Li-ion battery

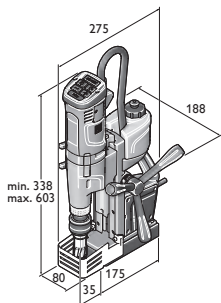

KBU 35 MQW

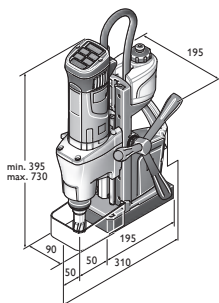

KBM 50 Q

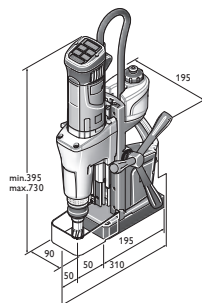

KBM 50 U

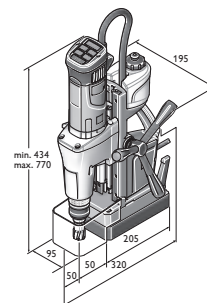

KBM 65 U

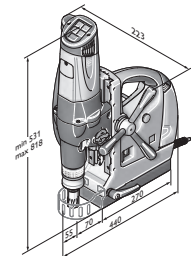

KBM 80 U

KBU 35 MQW	KBM 50 Q	KBM 50 U	KBM 65 U	KBM 80 U
Small and powerful single-speed universal magnetic core drill with clockwise/anti-clockwise operation, MT2 tool mounting and maximum functionality for flexible working on the construction site.	Lightweight and powerful 2-speed universal magnetic core drill with clockwise/anti-clockwise operation and maximum functionality for flexible working in the workshop and on the construction site.	Lightweight and powerful 2-speed universal magnetic core drill with clockwise/anti-clockwise operation, MT3 tool mounting and maximum functionality for flexible working in the workshop and on the construction site.	Powerful and very high-performance 2-speed universal magnetic core drill with clockwise/anti-clockwise operation, MT3 tool mounting, fine adjustment and maximum functionality for flexible working in the workshop.	Powerful and very high-performance 3-speed universal magnetic core drill with clockwise/anti-clockwise operation, MT3 tool mounting, fine adjustment and maximum functionality for flexible working in the workshop.
	110	111	111	111
	▲▲	▲▲	▲▲	▲▲
		▲▲	▲▲	▲▲
			▲▲	▲▲
	▲	▲	▲	▲
▲▲		▲▲	▲▲	▲▲
▲▲	▲▲	▲▲	▲▲	▲▲
▲▲	▲▲	▲▲	▲▲	▲▲
▲▲	▲▲	▲▲	▲▲	▲▲
▲▲	▲▲	▲▲	▲▲	▲▲
▲▲	▲▲	▲▲	▲▲	▲▲
▲▲	▲▲	▲▲	▲▲	▲▲
●	●	●	●	●
●	●	●	●	●
●	●	●	●	●
●	●	●	●	●
●	●	●	●	●
●	●	●	●	●
1 100 W	1 200 W	1 200 W	1 300 W	2 000 W
550 W	640 W	610 W	730 W	900 W
260 - 520 1/min				
	130 - 260 1/min	130 - 260 1/min	120 - 240 1/min	110 - 180 1/min
	260 - 520 1/min	260 - 520 1/min	260 - 520 1/min	160 - 260 1/min
				350 - 580 1/min
35 mm	50 mm	50 mm	65 mm	80 mm
35 mm	40 mm	40 mm	45 mm	65 mm
50(75)* mm	50 mm	50(75)* mm	50(75)* mm	50() mm
18 mm	16 mm	23 mm	25/ mm	32 mm
M 14	M 16	M 16	M 20	
31 mm	31 mm	50 mm	50 mm	50 mm
18 mm	16 mm	23 mm	25 mm	31 mm
3/4" Weldon	QuickIN	QuickIN	QuickIN	
MT 2		MK 3	MK 3	MK 3
135 mm	145 mm	145 mm	145 mm	145 mm
260 mm	315 mm	315 mm	315 mm	285 mm
			6 mm	4,25 mm
			7°	11°
10 000 N	12 500 N	12 500 N	14 000 N	18 000 N
175 x 80 mm	195 x 90 mm	195 x 90 mm	205 x 95 mm	270 x 90 mm
4 m	4 m	4 m	4 m	4 m
11,00 kg	13,20 kg	13,90 kg	16,10 kg	25,40 kg

Metal core drilling



Type	Part number	EAN	PC	£ List Price excl. VAT
<b>AKBU 35 PMQW</b>	<b>7 170 02 61 24 0</b>	<b>4014586888200</b>	<b>01</b>	<b>1,849.00</b>

**Price includes:**  
 2 x battery packs (HighPower Li-ion), 1 rapid charger ALG 50, 1 x coolant pump, 1 lashing strap, 1 swarf hook, 1 centering pin,  
 1 contact guard, 1 drift key, 1 case  
 For accessories, see page 112

## FEIN SELECT<sup>+</sup>



Type	Part number	EAN	PC	£ List Price excl. VAT
<b>AKBU 35 PMQW Select</b>	<b>7 170 02 62 00 0</b>	<b>4014586889122</b>	<b>01</b>	<b>1,590.00</b>

**Price includes:**  
 1 x coolant pump, 1 lashing strap, 1 swarf hook, 1 centering pin, 1 contact guard, 1 drift key, 1 case  
 For accessories, see page 112



Type	Part number	PC	£ List Price excl. VAT
<b>KBU 35 QW</b>	<b>7 270 54 61</b>	<b>01</b>	<b>1,342.00</b>

**Price includes:**  
 1 coolant tank, 1 lashing strap, 1 swarf hook, 1 centering pin, 1 contact guard, 1 case  
 For accessories, see page 112



Type	Part number	PC	£ List Price excl. VAT
<b>KBU 35-2 QW</b>	<b>7 270 58 61</b>	<b>01</b>	<b>1,698.00</b>

**Price includes:**  
 1 coolant tank, 1 lashing strap, 1 swarf hook, 1 centering pin, 1 contact guard, 1 case  
 For accessories, see page 112



Type	Part number	PC	£ List Price excl. VAT
<b>KBU 35 MQW</b>	<b>7 270 56 61</b>	<b>01</b>	<b>1,537.00</b>

**Price includes:**  
 1 coolant tank, 1 lashing strap, 1 swarf hook, 1 centering pin, 1 contact guard, 1 case  
 For accessories, see page 112





Type	Part number	PC	£ List Price excl. VAT
<b>KBM 50 Q</b>	<b>7 270 41 61</b>	<b>01</b>	<b>1,785.00</b>

**Price includes:**  
1 coolant tank, 1 lashing strap, 1 swarf hook, 1 centering pin, 1 contact guard, 1 case  
For accessories, see page 112



Type	Part number	PC	£ List Price excl. VAT
<b>KBM 50 U</b>	<b>7 270 40 61</b>	<b>01</b>	<b>2,061.00</b>

**Price includes:**  
1 coolant tank, 1 lashing strap, 1 swarf hook, 1 centering pin, 1 contact guard, 1 drift key, 1 case  
For accessories, see page 112



Type	Part number	PC	£ List Price excl. VAT
<b>KBM 65 U</b>	<b>7 270 43 61</b>	<b>01</b>	<b>2,511.00</b>

**Price includes:**  
1 coolant tank, 1 lashing strap, 1 swarf hook, 1 centering pin, 1 contact guard, 1 drift key, 1 case  
For accessories, see page 112



Type	Part number	PC	£ List Price excl. VAT
<b>KBM 80 U</b>	<b>7 270 34</b>	<b>01</b>	<b>3,786.00</b>

**Price includes:**  
1 QuickIN MAX/ MT3 tool mounting, 1 coolant tank, 1 lashing strap, 1 swarf hook, 2 centering pins, 1 drift key, 1 contact guard,  
1 case  
**For accessories, see page 122**

Metal  
core drilling

**Best of core drilling carbide accessory set**



**Best of core bits QuickIN**

Very long service life and outstanding cutting performance.  
Metric dimensions, cutting depth 35 mm.  
Set version, consisting of 6 core bits with diameters of 12, 14, 16, 18, 20 and 22 mm (cutting depth 35 mm) and 2 centring pins (105 mm) in plastic case.

Part number	£ List Price excl. VAT
6 31 27 086 04 0	253.77



**Best of core bits 3/4" Weldon**

Very long service life and outstanding cutting performance.  
Metric dimensions, cutting depth 35 mm.  
Set version, consisting of 6 core bits with diameters of 12, 14, 16, 18, 20 and 22 mm (cutting depth 35 mm) and 2 centring pins (105 mm) in plastic case.

Part number	£ List Price excl. VAT
6 31 27 714 02 0	253.77



**Best of core bits 3/4" Weldon**

Very long service life and outstanding cutting performance.  
Metric dimensions, cutting depth 50 mm.  
Set version, consisting of 6 core bits with diameters of 12, 14, 16, 18, 20 and 22 mm (cutting depth 50 mm) and 2 centring pins (105 mm) in plastic case.

Part number	£ List Price excl. VAT
6 31 27 276 02 0	292.05

**Carbide core drill**



**TCT Ultra core bit with QuickIN holder**

Very long service life and outstanding cutting performance.  
Metric dimensions, cutting depth 35 mm.

Bore Ø mm	Part number	£ List Price excl. VAT
12	6 31 27 086 01 9	53.90
13	6 31 27 087 01 3	53.90
14	6 31 27 088 01 1	53.90
15	6 31 27 089 01 5	53.90
15,5	6 31 27 238 01 1	52.56
16	6 31 27 090 01 7	53.90
17	6 31 27 091 01 6	53.90
17,5	6 31 27 239 01 5	53.90
18	6 31 27 092 01 9	53.90
19	6 31 27 093 01 3	53.90
19,5	6 31 27 240 01 7	49.87
20	6 31 27 094 01 1	53.90
21	6 31 27 095 01 5	53.90
22	6 31 27 096 01 8	53.90
23	6 31 27 097 01 2	53.90
24	6 31 27 098 01 0	53.90
25	6 31 27 099 01 4	53.90
26	6 31 27 100 01 5	53.90
26,5	6 31 27 241 01 6	52.56
27	6 31 27 101 01 4	53.90
28	6 31 27 102 01 7	53.90
29	6 31 27 103 01 1	60.48
30	6 31 27 104 01 9	62.07
31	6 31 27 105 01 3	62.07
32	6 31 27 106 01 6	62.07
33	6 31 27 107 01 0	62.07
34	6 31 27 108 01 8	62.07
35	6 31 27 109 01 2	62.07
36	6 31 27 110 01 4	71.83
37	6 31 27 111 01 3	70.03
38	6 31 27 112 01 6	71.83
39	6 31 27 113 01 0	70.03
40	6 31 27 114 01 8	71.83

41	6 31 27 115 01 2	84.92
42	6 31 27 116 01 5	84.92
43	6 31 27 117 01 9	82.76
44	6 31 27 118 01 7	84.92
45	6 31 27 119 01 1	84.92
46	6 31 27 120 01 3	92.37
47	6 31 27 121 01 2	92.37
48	6 31 27 122 01 5	92.37
49	6 31 27 123 01 9	92.37
50	6 31 27 124 01 7	94.77
51	6 31 27 125 01 1	104.62
52	6 31 27 126 01 4	104.62
53	6 31 27 127 01 8	96.76
54	6 31 27 128 01 6	104.62
55	6 31 27 129 01 0	104.62
56	6 31 27 130 01 2	106.42
57	6 31 27 131 01 1	106.42
58	6 31 27 132 01 4	106.42
59	6 31 27 133 01 8	106.42
60	6 31 27 134 01 6	109.18
61	6 31 27 135 01 0	123.48
62	6 31 27 136 01 3	120.37
63	6 31 27 137 01 7	123.48
64	6 31 27 138 01 5	120.37
65	6 31 27 139 01 9	123.48



**TCT Ultra core bit with QuickIN holder**

Very long service life and outstanding cutting performance.  
Metric dimensions, cutting depth 75 mm.

Bore Ø mm	Part number	£ List Price excl. VAT
18	6 31 27 763 01 0	76.52
19	6 31 27 764 01 0	76.52
20	6 31 27 765 01 0	76.52
21	6 31 27 766 01 0	76.52
22	6 31 27 767 01 0	72.57
23	6 31 27 768 01 0	76.52
24	6 31 27 769 01 0	76.52
25	6 31 27 770 01 0	76.52
26	6 31 27 771 01 0	72.57
27	6 31 27 772 01 0	76.52
28	6 31 27 773 01 0	76.52
29	6 31 27 774 01 0	84.25
30	6 31 27 775 01 0	84.25
32	6 31 27 776 01 0	84.25
35	6 31 27 777 01 0	84.25
36	6 31 27 778 01 0	93.58
40	6 31 27 779 01 0	93.58
45	6 31 27 780 01 0	105.98
50	6 31 27 781 01 0	115.32
55	6 31 27 782 01 0	124.77
60	6 31 27 783 01 0	129.05
65	6 31 27 784 01 0	142.67



**TCT Ultra 50 core bit with FEIN thread M 18 x 6 P 1.5**

Very long service life and outstanding cutting performance.  
Metric dimensions, cutting depth 50 mm.

Bore Ø mm	Part number	£ List Price excl. VAT
12	6 31 27 042 01 4	56.72
13	6 31 27 043 01 8	56.72
14	6 31 27 044 01 6	58.20
15	6 31 27 045 01 0	56.72
16	6 31 27 046 01 3	58.20
17	6 31 27 047 01 7	58.20
18	6 31 27 001 01 5	58.20
19	6 31 27 019 01 2	56.72
20	6 31 27 002 01 8	58.20



21	6 31 27 020 01 4	58.20
22	6 31 27 003 01 2	58.20
23	6 31 27 021 01 3	58.20
24	6 31 27 022 01 6	56.72
25	6 31 27 004 01 0	58.20
26	6 31 27 005 01 4	56.72
27	6 31 27 023 01 0	56.72
28	6 31 27 006 01 7	58.20
29	6 31 27 024 01 8	58.20
30	6 31 27 007 01 1	58.20
31	6 31 27 025 01 2	65.02
32	6 31 27 008 01 9	63.40
33	6 31 27 026 01 5	63.40
34	6 31 27 009 01 3	63.40
35	6 31 27 010 01 5	65.02
36	6 31 27 027 01 9	75.29
37	6 31 27 028 01 7	75.29
38	6 31 27 011 01 4	73.41
39	6 31 27 029 01 1	75.29
40	6 31 27 012 01 7	75.29
41	6 31 27 030 01 3	86.69
42	6 31 27 013 01 1	86.69
43	6 31 27 014 01 9	88.92
44	6 31 27 031 01 2	88.92
45	6 31 27 015 01 3	86.69
46	6 31 27 032 01 5	99.31
47	6 31 27 033 01 9	96.79
48	6 31 27 016 01 6	99.31
49	6 31 27 034 01 7	96.79
50	6 31 27 017 01 0	96.79
51	6 31 27 035 01 1	109.73
52	6 31 27 018 01 8	106.95
53	6 31 27 036 01 4	109.73
54	6 31 27 037 01 8	106.95
55	6 31 27 038 01 6	106.95
56	6 31 27 039 01 0	111.47
57	6 31 27 040 01 2	111.47
58	6 31 27 041 01 1	111.47
59	6 31 27 049 01 9	113.11
60	6 31 27 050 01 1	116.00
61	6 31 27 051 01 0	128.00
62	6 31 27 052 01 3	128.00
63	6 31 27 053 01 7	128.00
64	6 31 27 054 01 5	128.00
65	6 31 27 055 01 9	131.33



**TCT Ultra 35 core bit with 3/4" Weldon holder**  
Very long service life and outstanding cutting performance.  
Metric dimensions, cutting depth 35 mm.

Bore Ø mm	Part number	£ List Price excl. VAT
12	6 31 27 714 01 0	48.43
13	6 31 27 715 01 0	48.43
14	6 31 27 716 01 0	48.39
15	6 31 27 717 01 0	48.43
16	6 31 27 718 01 0	48.43
17	6 31 27 719 01 0	48.43
18	6 31 27 720 01 0	48.39
19	6 31 27 721 01 0	48.43
20	6 31 27 722 01 0	48.43
21	6 31 27 723 01 0	48.43
22	6 31 27 724 01 0	48.43
23	6 31 27 725 01 0	48.43
24	6 31 27 726 01 0	48.43
25	6 31 27 727 01 0	48.43
26	6 31 27 728 01 0	48.43
27	6 31 27 729 01 0	48.43

28	6 31 27 730 01 0	48.43
29	6 31 27 731 01 0	55.72
30	6 31 27 732 01 0	55.72
31	6 31 27 733 01 0	55.72
32	6 31 27 734 01 0	55.72
33	6 31 27 735 01 0	55.72
34	6 31 27 736 01 0	55.72
35	6 31 27 737 01 0	55.72
36	6 31 27 738 01 0	67.99
37	6 31 27 739 01 0	67.99
38	6 31 27 740 01 0	67.99
39	6 31 27 741 01 0	67.99
40	6 31 27 742 01 0	67.99
41	6 31 27 743 01 0	80.36
42	6 31 27 744 01 0	80.36
43	6 31 27 745 01 0	80.36
44	6 31 27 746 01 0	80.36
45	6 31 27 747 01 0	80.36
46	6 31 27 748 01 0	89.65
47	6 31 27 749 01 0	89.65
48	6 31 27 750 01 0	89.65
49	6 31 27 751 01 0	89.65
50	6 31 27 752 01 0	89.65
51	6 31 27 753 01 0	99.05
52	6 31 27 754 01 0	99.05
53	6 31 27 755 01 0	99.05
54	6 31 27 756 01 0	99.05
55	6 31 27 757 01 0	99.05
56	6 31 27 758 01 0	103.32
57	6 31 27 759 01 0	103.32
58	6 31 27 760 01 0	103.32
59	6 31 27 761 01 0	103.32
60	6 31 27 762 01 0	106.03



**TCT Ultra 50 core bit with 3/4" Weldon holder**  
Very long service life and outstanding cutting performance.  
Metric dimensions, cutting depth 50 mm.

Bore Ø mm	Part number	£ List Price excl. VAT
12	6 31 27 276 01 0	56.72
13	6 31 27 277 01 0	53.81
14	6 31 27 278 01 0	56.72
15	6 31 27 279 01 0	56.72
16	6 31 27 280 01 0	56.72
17	6 31 27 281 01 0	56.72
18	6 31 27 282 01 0	56.72
19	6 31 27 283 01 0	56.72
20	6 31 27 284 01 0	56.72
21	6 31 27 285 01 0	56.72
22	6 31 27 286 01 0	56.72
23	6 31 27 287 01 0	56.72
24	6 31 27 288 01 0	56.72
25	6 31 27 289 01 0	56.72
26	6 31 27 290 01 0	56.72
27	6 31 27 291 01 0	56.72
28	6 31 27 292 01 0	56.72
29	6 31 27 293 01 0	56.72
30	6 31 27 294 01 0	56.72
31	6 31 27 295 01 0	63.40
32	6 31 27 296 01 0	63.40
33	6 31 27 297 01 0	63.40
34	6 31 27 298 01 0	63.40
35	6 31 27 299 01 0	63.40
36	6 31 27 300 01 0	73.41
37	6 31 27 301 01 0	73.41
38	6 31 27 302 01 0	73.41
39	6 31 27 303 01 0	73.41

40	6 31 27 304 01 0	73.41
41	6 31 27 305 01 0	86.69
42	6 31 27 306 01 0	86.69
43	6 31 27 307 01 0	86.69
44	6 31 27 308 01 0	86.69
45	6 31 27 309 01 0	86.69
46	6 31 27 310 01 0	96.79
47	6 31 27 311 01 0	96.79
48	6 31 27 312 01 0	96.79
49	6 31 27 313 01 0	96.79
50	6 31 27 314 01 0	96.79
51	6 31 27 315 01 0	106.95
52	6 31 27 316 01 0	106.95
53	6 31 27 317 01 0	106.95
54	6 31 27 318 01 0	106.95
55	6 31 27 319 01 0	106.95
56	6 31 27 320 01 0	111.47
57	6 31 27 321 01 0	111.47
58	6 31 27 322 01 0	111.47
59	6 31 27 323 01 0	111.47
60	6 31 27 324 01 0	111.47
61	6 31 27 325 01 0	126.14
62	6 31 27 326 01 0	126.14
63	6 31 27 327 01 0	126.14
64	6 31 27 328 01 0	126.14
65	6 31 27 329 01 0	126.14



**TCT Ultra 75 core bit with 3/4" Weldon holder**  
Very long service life and outstanding cutting performance.  
Metric dimensions, cutting depth 75 mm.

Bore Ø mm	Part number	£ List Price excl. VAT
18	6 31 27 785 01 0	76.52
19	6 31 27 786 01 0	76.52
20	6 31 27 787 01 0	72.57
21	6 31 27 788 01 0	76.52
22	6 31 27 789 01 0	72.57
23	6 31 27 790 01 0	76.52
24	6 31 27 791 01 0	72.57
25	6 31 27 792 01 0	76.52
26	6 31 27 793 01 0	72.57
27	6 31 27 794 01 0	76.52
28	6 31 27 795 01 0	72.57
29	6 31 27 796 01 0	84.25
30	6 31 27 797 01 0	79.91
32	6 31 27 798 01 0	79.91
35	6 31 27 799 01 0	79.91
36	6 31 27 800 01 0	88.74
40	6 31 27 801 01 0	88.74
45	6 31 27 802 01 0	100.53
50	6 31 27 803 01 0	109.40
55	6 31 27 804 01 0	118.35
60	6 31 27 805 01 0	129.05
65	6 31 27 806 01 0	142.67

**Best of core drilling HSS accessory set**



**Best of core bits QuickIN**  
Industrial standard. Metric dimensions, cutting depth 50 mm.  
Set version, consisting of 6 core bits with diameters of 12, 14, 16, 18, 20 and 22 mm (cutting depth 50 mm) and 2 centring pins (105 mm) in plastic case.

Part number	£ List Price excl. VAT
6 31 33 999 01 0	190.16



**Best of core bits 3/4" Weldon**

Industrial standard. Metric dimensions, cutting depth 25 mm.  
Set version, consisting of 6 core bits with diameters of 12, 14, 16, 18, 20 and 22 mm (cutting depth 25 mm) and 2 centring pins (80 mm) in plastic case.

Part number	£ List Price excl. VAT
6 31 34 999 06 1	151.91



**Best of core bits 3/4" Weldon**

Industrial standard. Metric dimensions, cutting depth 25 mm.  
Set version, consisting of 4 core bits, 2x 14 mm diameter, 2x 18 mm diameter, (cutting depth 25 mm) and 1 centring pin (80 mm) in plastic case.

Part number	£ List Price excl. VAT
6 31 34 999 06 2	95.71



**Best of core bits 3/4" Weldon**

Industrial standard. Metric dimensions, cutting depth 50 mm.  
Set version, consisting of 6 core bits with diameters of 12, 14, 16, 18, 20 and 22 mm (cutting depth 50 mm) and 2 centring pins (105 mm) in plastic case.

Part number	£ List Price excl. VAT
6 31 34 999 06 3	190.16



**Best of core bits 3/4" Weldon**

Industrial standard. Metric dimensions, cutting depth 50 mm.  
Set version, consisting of 4 core bits, 2x 14 mm diameter, 2x 18 mm diameter, (cutting depth 50 mm) and 1 centring pin (105 mm) in plastic case.

Part number	£ List Price excl. VAT
6 31 34 999 06 4	126.40

**HSS core drill**



**HSS Nova 25 core bit with QuickIN holder**

Industrial standard. Metric dimensions, cutting depth 25 mm.

Bore Ø mm	Part number	£ List Price excl. VAT
12	6 31 33 119 05 1	20.93
13	6 31 33 129 05 1	19.33
14	6 31 33 140 05 1	20.93
15	6 31 33 150 05 1	19.33
16	6 31 33 159 05 1	20.93
17	6 31 33 170 05 1	22.84
18	6 31 33 180 05 1	22.84
19	6 31 33 189 05 1	22.22
20	6 31 33 199 06 3	26.64
21	6 31 33 210 05 1	26.64
22	6 31 33 219 05 1	26.64
23	6 31 33 229 05 1	28.15
24	6 31 33 240 05 1	29.65
25	6 31 33 250 05 1	30.44
26	6 31 33 259 05 1	34.58
27	6 31 33 270 05 1	34.58
28	6 31 33 279 05 1	37.05
29	6 31 33 289 05 1	37.05
30	6 31 33 299 05 1	37.48
31	6 31 33 309 05 1	39.52
32	6 31 33 319 05 1	43.34
33	6 31 33 329 05 1	45.68
34	6 31 33 339 05 1	51.84



35	6 31 33 350 05 1	51.84
36	6 31 33 359 05 1	51.84
37	6 31 33 369 05 1	60.49
38	6 31 33 379 05 1	60.49
39	6 31 33 389 05 1	60.49
40	6 31 33 399 05 1	67.91
41	6 31 33 409 05 1	67.91
42	6 31 33 420 05 1	74.09
43	6 31 33 429 05 1	74.09
44	6 31 33 439 05 1	77.79
45	6 31 33 449 05 1	77.79
46	6 31 33 459 05 1	88.91
47	6 31 33 469 05 1	88.91
48	6 31 33 479 05 1	92.60
49	6 31 33 489 05 1	92.60
50	6 31 33 499 05 1	92.60



**HSS Nova 50 core bit with QuickIN holder**  
Industrial standard. Metric dimensions, cutting depth 50 mm.

Bore Ø mm	Part number	£ List Price excl. VAT
12	6 31 33 119 05 2	29.34
13	6 31 33 129 05 2	29.34
14	6 31 33 140 05 2	29.34
15	6 31 33 150 05 2	28.59
16	6 31 33 159 05 2	29.34
17	6 31 33 170 05 2	31.18
18	6 31 33 180 05 2	32.02
19	6 31 33 189 05 2	31.18
20	6 31 33 199 05 2	34.52
21	6 31 33 210 05 2	36.40
22	6 31 33 219 05 2	37.36
23	6 31 33 229 05 2	34.52
24	6 31 33 240 05 2	39.00
25	6 31 33 250 05 2	44.20
26	6 31 33 259 05 2	45.39
27	6 31 33 270 05 2	41.92
28	6 31 33 279 05 2	51.98
29	6 31 33 289 05 2	51.98
30	6 31 33 299 05 2	51.98
31	6 31 33 309 05 2	58.49
32	6 31 33 319 05 2	58.49
33	6 31 33 329 05 2	66.70
34	6 31 33 339 05 2	61.67
35	6 31 33 350 05 2	65.00
36	6 31 33 359 05 2	74.09
37	6 31 33 369 05 2	74.09
38	6 31 33 379 05 2	74.09
39	6 31 33 389 05 2	84.49
40	6 31 33 399 05 2	84.49
41	6 31 33 409 05 2	90.97
42	6 31 33 420 05 2	98.77
43	6 31 33 429 05 2	98.77
44	6 31 33 439 05 2	98.77
45	6 31 33 449 05 2	103.98
46	6 31 33 459 05 2	114.37
47	6 31 33 469 05 2	114.37
48	6 31 33 479 05 2	119.57
49	6 31 33 489 05 2	119.57
50	6 31 33 499 05 2	126.76



**HSS Nova 25 core bit with 3/4" Weldon holder**  
Industrial standard. Metric dimensions, cutting depth 25 mm.

Bore Ø mm	Part number	£ List Price excl. VAT
12	6 31 34 120 05 1	20.93
13	6 31 34 130 05 1	19.33
14	6 31 34 140 05 1	20.93
15	6 31 34 150 05 1	19.33
16	6 31 34 160 05 1	20.93
17	6 31 34 170 05 1	22.84
18	6 31 34 180 05 1	22.84
19	6 31 34 190 05 1	21.06
20	6 31 34 200 05 1	26.64
21	6 31 34 210 05 1	26.64
22	6 31 34 220 05 1	26.64
23	6 31 34 230 05 1	28.15
24	6 31 34 240 05 1	30.44
25	6 31 34 250 05 1	30.44
26	6 31 34 260 05 1	35.53
27	6 31 34 270 05 1	32.82
28	6 31 34 280 05 1	38.03
29	6 31 34 290 05 1	35.14
30	6 31 34 300 05 1	40.57
31	6 31 34 310 05 1	37.48
32	6 31 34 320 05 1	46.92
33	6 31 34 330 05 1	43.34
34	6 31 34 340 05 1	49.18
35	6 31 34 350 05 1	49.18
36	6 31 34 360 05 1	51.84
37	6 31 34 370 05 1	60.49
38	6 31 34 380 05 1	57.36
39	6 31 34 390 05 1	60.49
40	6 31 34 400 05 1	67.91
41	6 31 34 410 05 1	67.91
42	6 31 34 420 05 1	74.09
43	6 31 34 430 05 1	74.09
44	6 31 34 440 05 1	77.79
45	6 31 34 450 05 1	73.79
46	6 31 34 460 05 1	88.91
47	6 31 34 470 05 1	88.91
48	6 31 34 480 05 1	92.60
49	6 31 34 490 05 1	92.60
50	6 31 34 500 05 1	95.12
51	6 31 34 510 05 1	98.77
52	6 31 34 520 05 1	98.77
53	6 31 34 530 05 1	104.96
54	6 31 34 540 05 1	104.96
55	6 31 34 550 05 1	114.83
56	6 31 34 560 05 1	130.88
57	6 31 34 570 05 1	130.88
58	6 31 34 580 05 1	140.75
59	6 31 34 590 05 1	140.75
60	6 31 34 600 05 1	144.54



**HSS Nova 50 core bit with 3/4" Weldon holder**  
Industrial standard. Metric dimensions, cutting depth 50 mm.

Bore Ø mm	Part number	£ List Price excl. VAT
12	6 31 34 120 05 2	29.34
13	6 31 34 130 05 2	27.10
14	6 31 34 140 05 2	29.34
15	6 31 34 150 05 2	27.10
16	6 31 34 160 05 2	29.34
17	6 31 34 170 05 2	29.58
18	6 31 34 180 05 2	32.02
19	6 31 34 190 05 2	29.58
20	6 31 34 200 05 2	37.36
21	6 31 34 210 05 2	34.52
22	6 31 34 220 05 2	37.36
23	6 31 34 230 05 2	34.52
24	6 31 34 240 05 2	40.07
25	6 31 34 250 05 2	41.92
26	6 31 34 260 05 2	45.39
27	6 31 34 270 05 2	41.92
28	6 31 34 280 05 2	53.37
29	6 31 34 290 05 2	49.27
30	6 31 34 300 05 2	53.37
31	6 31 34 310 05 2	55.50
32	6 31 34 320 05 2	55.50
33	6 31 34 330 05 2	61.67
34	6 31 34 340 05 2	61.67
35	6 31 34 350 05 2	61.67
36	6 31 34 360 05 2	70.26
37	6 31 34 370 05 2	70.26
38	6 31 34 380 05 2	76.08
39	6 31 34 390 05 2	80.12
40	6 31 34 400 05 2	80.12
41	6 31 34 410 05 2	86.29
42	6 31 34 420 05 2	93.70
43	6 31 34 430 05 2	93.70
44	6 31 34 440 05 2	93.70
45	6 31 34 450 05 2	98.61
46	6 31 34 460 05 2	108.48
47	6 31 34 470 05 2	108.48
48	6 31 34 480 05 2	113.40
49	6 31 34 490 05 2	113.40
50	6 31 34 500 05 2	117.12
51	6 31 34 510 05 2	136.47
52	6 31 34 520 05 2	136.47
53	6 31 34 530 05 2	136.47
54	6 31 34 540 05 2	142.97
55	6 31 34 550 05 2	142.97
56	6 31 34 560 05 2	149.45
57	6 31 34 570 05 2	149.45
58	6 31 34 580 05 2	159.86
59	6 31 34 590 05 2	159.86
60	6 31 34 600 05 2	159.86



**HSS Nova 75 core bit with 3/4" Weldon holder**  
Industrial standard. Metric dimensions, cutting depth 75 mm.

Bore Ø mm	Part number	£ List Price excl. VAT
19	6 31 34 190 05 3	68.74
20	6 31 34 200 05 3	68.74
21	6 31 34 210 05 3	72.29
22	6 31 34 220 05 3	74.21
23	6 31 34 230 05 3	72.29
24	6 31 34 240 05 3	74.21
25	6 31 34 250 05 3	84.34
26	6 31 34 260 05 3	86.61
27	6 31 34 270 05 3	84.34
28	6 31 34 280 05 3	96.25
29	6 31 34 290 05 3	93.72
30	6 31 34 300 05 3	111.38
32	6 31 34 320 05 3	111.38
35	6 31 34 350 05 3	116.46
36	6 31 34 360 05 3	129.21
40	6 31 34 400 05 3	158.07
45	6 31 34 450 05 3	160.64
50	6 31 34 500 05 3	180.72
60	6 31 34 600 05 3	226.81



**HSS DURA 25 core bit with QuickIN holder**  
TiN surface coating for outstanding service lives and the best glide properties.  
Metric dimensions, cutting depth 25 mm.

Bore Ø mm	Part number	£ List Price excl. VAT
12	6 31 33 120 06 7	30.02
13	6 31 33 130 06 7	30.02
14	6 31 33 140 06 7	28.48
15	6 31 33 150 06 7	30.02
16	6 31 33 160 06 7	28.48
17	6 31 33 170 06 7	32.76
18	6 31 33 180 06 7	31.07
19	6 31 33 190 06 7	33.63
20	6 31 33 200 06 7	34.92
21	6 31 33 210 06 7	36.84
22	6 31 33 220 06 7	34.92
23	6 31 33 230 06 7	45.03
24	6 31 33 240 06 7	45.03
25	6 31 33 250 06 7	45.03
26	6 31 33 260 06 7	46.59
27	6 31 33 270 06 7	49.13
28	6 31 33 280 06 7	53.21
29	6 31 33 290 06 7	53.21
30	6 31 33 300 06 7	58.67
31	6 31 33 310 06 7	58.67
32	6 31 33 320 06 7	63.47
33	6 31 33 330 06 7	66.88
34	6 31 33 340 06 7	73.69
35	6 31 33 350 06 7	73.69
36	6 31 33 360 06 7	73.69
37	6 31 33 370 06 7	83.25
38	6 31 33 380 06 7	83.25
39	6 31 33 390 06 7	83.25
40	6 31 33 400 06 7	92.78
41	6 31 33 410 06 7	92.78
42	6 31 33 420 06 7	100.99
43	6 31 33 430 06 7	100.99
44	6 31 33 440 06 7	107.79
45	6 31 33 450 06 7	107.79
46	6 31 33 460 06 7	120.08
47	6 31 33 470 06 7	120.08
48	6 31 33 480 06 7	131.01
49	6 31 33 490 06 7	131.01
50	6 31 33 500 06 7	131.01



**HSS DURA 50 core bit with QuickIN holder**

TiN surface coating for outstanding service lives and the best glide properties.  
Metric dimensions, cutting depth 50 mm.

Bore Ø mm	Part number	£ List Price excl. VAT
12	6 31 33 120 06 8	38.19
13	6 31 33 130 06 8	38.19
14	6 31 33 140 06 8	36.24
15	6 31 33 150 06 8	38.19
16	6 31 33 160 06 8	38.19
17	6 31 33 170 06 8	40.95
18	6 31 33 180 06 8	42.04
19	6 31 33 190 06 8	40.95
20	6 31 33 200 06 8	46.41
21	6 31 33 210 06 8	46.41
22	6 31 33 220 06 8	47.62
23	6 31 33 230 06 8	54.59
24	6 31 33 240 06 8	54.59
25	6 31 33 250 06 8	54.59
26	6 31 33 260 06 8	61.42
27	6 31 33 270 06 8	61.42
28	6 31 33 280 06 8	66.88
29	6 31 33 290 06 8	66.88
30	6 31 33 300 06 8	73.69
31	6 31 33 310 06 8	73.69
32	6 31 33 320 06 8	83.25
33	6 31 33 330 06 8	83.25
34	6 31 33 340 06 8	92.78
35	6 31 33 350 06 8	92.78
36	6 31 33 360 06 8	92.78
37	6 31 33 370 06 8	103.72
38	6 31 33 380 06 8	103.72
39	6 31 33 390 06 8	103.72
40	6 31 33 400 06 8	115.99
41	6 31 33 410 06 8	115.99
42	6 31 33 420 06 8	126.90
43	6 31 33 430 06 8	126.90
44	6 31 33 440 06 8	136.47
45	6 31 33 450 06 8	136.47
46	6 31 33 460 06 8	152.86
47	6 31 33 470 06 8	152.86
48	6 31 33 480 06 8	163.76
49	6 31 33 490 06 8	163.76
50	6 31 33 500 06 8	163.76



**HSS DURA 25 core bit with 3/4" Weldon holder**

TiN surface coating for outstanding service lives and the best glide properties.  
Metric dimensions, cutting depth 25 mm.

Bore Ø mm	Part number	£ List Price excl. VAT
12	6 31 34 120 07 5	30.02
13	6 31 34 130 07 5	30.02
14	6 31 34 140 07 5	30.82
15	6 31 34 150 07 5	30.02
16	6 31 34 160 07 5	30.82
17	6 31 34 170 07 5	32.76
18	6 31 34 180 07 5	31.07
19	6 31 34 190 07 5	32.76
20	6 31 34 200 07 5	36.84
21	6 31 34 210 07 5	36.84
22	6 31 34 220 07 5	34.92
23	6 31 34 230 07 5	45.03
24	6 31 34 240 07 5	45.03
25	6 31 34 250 07 5	45.03
26	6 31 34 260 07 5	50.45
27	6 31 34 270 07 5	49.13
28	6 31 34 280 07 5	53.21
29	6 31 34 290 07 5	53.21

30	6 31 34 300 07 5	58.67
31	6 31 34 310 07 5	58.67
32	6 31 34 320 07 5	66.88
33	6 31 34 330 07 5	66.88
34	6 31 34 340 07 5	69.89
35	6 31 34 350 07 5	73.69
36	6 31 34 360 07 5	73.69
37	6 31 34 370 07 5	83.25
38	6 31 34 380 07 5	83.25
39	6 31 34 390 07 5	83.25
40	6 31 34 400 07 5	92.78
41	6 31 34 410 07 5	92.78
42	6 31 34 420 07 5	100.99
43	6 31 34 430 07 5	100.99
44	6 31 34 440 07 5	107.79
45	6 31 34 450 07 5	107.79
46	6 31 34 460 07 5	120.08
47	6 31 34 470 07 5	120.08
48	6 31 34 480 07 5	131.01
49	6 31 34 490 07 5	131.01
50	6 31 34 500 07 5	134.54
51	6 31 34 510 07 5	139.19
52	6 31 34 520 07 5	139.19
53	6 31 34 530 07 5	146.02
54	6 31 34 540 07 5	146.02
55	6 31 34 550 07 5	150.12
56	6 31 34 560 07 5	156.94
57	6 31 34 570 07 5	156.94
58	6 31 34 580 07 5	170.59
59	6 31 34 590 07 5	170.59
60	6 31 34 600 07 5	170.59



**HSS DURA 50 core bit with 3/4" Weldon holder**

TiN surface coating for outstanding service lives and the best glide properties.  
Metric dimensions, cutting depth 50 mm.

Bore Ø mm	Part number	£ List Price excl. VAT
12	6 31 34 120 07 6	36.24
13	6 31 34 130 07 6	36.24
14	6 31 34 140 07 6	39.25
15	6 31 34 150 07 6	36.24
16	6 31 34 160 07 6	36.24
17	6 31 34 170 07 6	38.82
18	6 31 34 180 07 6	42.04
19	6 31 34 190 07 6	38.82
20	6 31 34 200 07 6	47.62
21	6 31 34 210 07 6	44.02
22	6 31 34 220 07 6	47.62
23	6 31 34 230 07 6	51.80
24	6 31 34 240 07 6	51.80
25	6 31 34 250 07 6	51.80
26	6 31 34 260 07 6	58.26
27	6 31 34 270 07 6	58.26
28	6 31 34 280 07 6	63.47
29	6 31 34 290 07 6	63.47
30	6 31 34 300 07 6	69.89
31	6 31 34 310 07 6	69.89
32	6 31 34 320 07 6	78.95
33	6 31 34 330 07 6	85.48
34	6 31 34 340 07 6	88.02
35	6 31 34 350 07 6	88.02
36	6 31 34 360 07 6	88.02
37	6 31 34 370 07 6	98.39
38	6 31 34 380 07 6	98.39
39	6 31 34 390 07 6	98.39
40	6 31 34 400 07 6	110.03
41	6 31 34 410 07 6	110.03
42	6 31 34 420 07 6	120.38

43	6 31 34 430 07 6	120.38
44	6 31 34 440 07 6	129.47
45	6 31 34 450 07 6	129.47
46	6 31 34 460 07 6	144.98
47	6 31 34 470 07 6	144.98
48	6 31 34 480 07 6	155.32
49	6 31 34 490 07 6	155.32
50	6 31 34 500 07 6	155.32
51	6 31 34 510 07 6	174.66
52	6 31 34 520 07 6	174.66
53	6 31 34 530 07 6	184.21
54	6 31 34 540 07 6	184.21
55	6 31 34 550 07 6	188.31
56	6 31 34 560 07 6	196.50
57	6 31 34 570 07 6	196.50
58	6 31 34 580 07 6	212.89
59	6 31 34 590 07 6	212.89
60	6 31 34 600 07 6	212.89

**Centering pins**



**Centering pins**

L mm	Part number	£ List Price excl. VAT
80	3 02 17 359 00 0	15.28
105	3 02 17 332 00 9	15.74
125	3 02 17 333 00 3	15.74
135	3 02 17 355 00 0	18.90



**Centering pins**  
only for 7/16" HSS Nova 1" core drills.

L mm	Part number	£ List Price excl. VAT
85	3 02 17 338 00 0	14.02



**Centering pins**  
only for 7/16" competitor core drill in combination with adapter

L mm	Part number	£ List Price excl. VAT
125	3 02 17 337 00 2	18.90

**Adapter/drill chuck**



**QuickIN-adapter**  
Output M18 x 6 P 1.5

Part number	£ List Price excl. VAT
6 39 01 020 00 6	23.15



**QuickIN-adapter**  
Output 3/4" Weldon

Part number	£ List Price excl. VAT
6 39 01 021 01 4	23.15



**QuickIN-adapter**  
Special Weldon output. Specially designed for core bits from other manufacturers that have an internal hole of > 6.4 mm.

Part number	£ List Price excl. VAT
6 39 01 024 01 9	23.15



**QuickIN-adapter**  
Output 1/2"-20 UNF

Part number	£ List Price excl. VAT
6 39 01 022 00 8	23.15



**QuickIN-adapter**  
Output B 16

Part number	£ List Price excl. VAT
6 39 01 023 00 2	23.15



**Adapter with 3/4" Weldon fitting**  
for converting competitor products to the QuickIN system.

Part number	£ List Price excl. VAT
6 39 01 027 01 0	49.77



**Adapter with 3/4" Weldon fitting**  
Output B 16

Part number	£ List Price excl. VAT
6 39 01 061 00 0	23.15

**Adapter with 3/4" Weldon fitting**  
Output 1/2"-20 UNF

Part number	£ List Price excl. VAT
6 39 01 070 00 0	22.71



**Extension**  
for use on confined, deep, or layered surfaces, through holes possible as of Ø 36 mm. QuickIN fitting, length 100 mm, including centring pin.

Part number	£ List Price excl. VAT
6 31 06 016 01 0	83.72



**Key-type drill chuck with QuickIN holder**

Chuck opening mm	Part number	£ List Price excl. VAT
1,5 - 13	6 39 01 023 02 0	74.97
1 - 16	6 39 01 023 01 1	88.88



**HSS spiral drill with QuickIN fitting**  
Cutting depth 35 mm

Bore Ø mm	Part number	£ List Price excl. VAT
10	6 31 11 009 01 0	21.25
10,2	6 31 11 010 01 0	21.25
11	6 31 11 011 01 0	24.19
12	6 31 11 012 01 0	24.19
13	6 31 11 013 01 0	25.96
14	6 31 11 014 01 0	25.96
15	6 31 11 015 01 0	27.14
15,5	6 31 11 016 01 0	27.14

**Drive arbors**



**QuickIN-adapter**  
With internal cooling lubricant supply.

Cutting depth mm	Taper	Bore Ø mm	Part number	£ List Price excl. VAT
50	MT 2	12 - 35	6 39 01 065 02 0	179.86
75	MT 2	12 - 35	6 39 01 066 02 0	192.76
50	MK 3	12 - 65	6 39 01 048 02 0	169.32
75	MK 3	12 - 65	6 39 01 049 02 0	192.76



**3/4" Weldon mounting shaft**  
With internal cooling lubricant supply.

Cutting depth mm	Taper	Bore Ø mm	Part number	£ List Price excl. VAT
50	MT 2	12 - 35	6 39 01 063 02 0	169.35
75	MT 2	12 - 35	6 39 01 064 02 0	192.76
50	MK 3	12 - 65	6 39 01 050 02 0	183.28
75	MK 3	12 - 65	6 39 01 051 02 0	192.76





**QuickIN-adaptors**

for using FEIN core drills on bench and column drilling machines and all other core drilling units with MT fitting.

Cutting depth mm	Taper	Bore Ø mm	Part number	£ List Price excl. VAT
50	MK 3	12 - 65	6 39 01 019 01 3	188.93
50	MT 2	12 - 35	6 39 01 018 01 9	183.28
75	MK 3	12 - 65	6 39 01 055 02 0	201.82
75	MT 2	12 - 35	6 39 01 057 02 0	201.82



**3/4" Weldon mounting shaft**

for using FEIN core drills on bench and column drilling machines and all other core drilling units with MT fitting.

Cutting depth mm	Taper	Bore Ø mm	Part number	£ List Price excl. VAT
50	MK 3	12 - 65	6 39 01 052 02 0	188.93
75	MK 3	12 - 65	6 39 01 053 02 0	201.82



**Retro-fitting kit**

for former model KBM 542 to QuickIN rapid change system.

Part number	£ List Price excl. VAT
6 39 01 028 01 8	122.03

**Tapping**



**Tapping rapid change chuck for KBM 50 Q, KBM 50 U, KBM 52 U, KBM 65 U**

Can only be used for magnetic core drills with reverse running function. Size 2, with 3/4" Weldon fitting, for thread drills, in conjunction with tapping inserts with or without M6-M20 safety clutch.

Part number	£ List Price excl. VAT
9 26 02 089 01 0	293.58



**Tapping rapid change chuck for KBM 50 Q, KBM 50 U, KBM 52 U, KBM 65 U**

can only be used for core drilling units with left-hand running function. Size 2, with QuickIN fitting, for tapping drills in connection with tapping inserts with or without slipping clutch M 6 - M 20.

Part number	£ List Price excl. VAT
9 26 02 079 01 0	293.55



**Thread cutting tool for KBM 32 Q and KBM 50 QX**

Size 2, with QuickIN fitting, for tapping drills in connection with tapping inserts with or without slipping clutch M6 - M16. Including torque support.

Part number	£ List Price excl. VAT
9 26 02 072 01 2	1,151.00



**Thread cutting tool for KBM 65 Q and KBM 65 QF**

Size 2, with MT 3 fitting, for tapping drills in connection with tapping inserts with or without slipping clutch M6 - M20. Including torque support.

Part number	£ List Price excl. VAT
9 26 02 066 01 2	1,553.00



**Tapping Inserts**

for thread drills in accordance with DIN 371

Thread	Ø mm	Square mm	Part number	£ List Price excl. VAT
M 6	6	4,9	6 32 06 095 01 1	78.58
M 8	8	6,2	6 32 06 138 01 0	72.57
M 10	10	8	6 32 06 139 01 0	72.57



**Tapping Inserts**

for thread drills in accordance with DIN 374/376

Thread	Ø mm	Square mm	Part number	£ List Price excl. VAT
M 6	4,5	3,4	6 32 06 117 01 5	77.10
M 10	7	5,5	6 32 06 096 01 4	78.58
M 12	9	7	6 32 06 097 01 8	78.58
M 14	11	9	6 32 06 098 01 6	78.58
M 16	12	9	6 32 06 099 01 0	78.58
M 18	14	11	6 32 06 100 01 1	78.58
M 20	16	12	6 32 06 101 01 0	78.58



**Tapping Inserts**

with safety coupling for blind holes. for thread drills in accordance with DIN 371

Thread	Ø mm	Square mm	Part number	£ List Price excl. VAT
M 6	6	4,9	6 32 06 118 01 3	239.98
M 8	8	6,2	6 32 06 140 01 0	239.98
M 10	10	8	6 32 06 141 01 0	239.98



**Tapping Inserts**

with safety coupling for blind holes. for thread drills in accordance with DIN 374/376

Thread	Ø mm	Square mm	Part number	£ List Price excl. VAT
M 8	6	4,9	6 32 06 102 01 3	239.98
M 10	7	5,5	6 32 06 103 01 7	239.98
M 12	9	7	6 32 06 104 01 5	244.59
M 14	11	9	6 32 06 105 01 9	239.98
M 16	12	9	6 32 06 106 01 2	239.98
M 18	14	11	6 32 06 107 01 6	239.98
M 20	16	12	6 32 06 108 01 4	244.59

**Clamping fixtures**



**Vacuum plate**

for anti-magnetic materials and structured bases (corrugated sheet, stud plate etc.)  
Vacuum plate 396 x 200 x 95 mm

Part number	£ List Price excl. VAT
9 26 02 057 01 7	544.10



**Vacuum pump**

Suction rate 0,015 m<sup>3</sup>/min, -0,8 bar, 92 W, weight 2,5 kg including suction hose

Part number	£ List Price excl. VAT
9 26 01 022 01 3	571.86



**Suction plate**

for anti-magnetic materials, 250 x 330 x 110 mm

Part number	£ List Price excl. VAT
9 26 02 054 01 6	523.63



**Pipe drilling device**

incl. clamping strap, for positioning bores on pipes with pipe Ø of 60 to 300 mm, 220 x 130 mm.

Part number	£ List Price excl. VAT
9 26 02 055 01 0	291.04

**Cooling**



**Pump**

Capacity approx. 450 ml. Suited to FEIN core drilling units KBM 32 Q, KBM 50 QX, KBM 52 U, KBM 65 Q, KBM 65 QF.

Part number	£ List Price excl. VAT
3 21 32 022 00 7	10.98

**Replacement hose**

for hand pump 3 21 32 022 00 7.

Part number	£ List Price excl. VAT
3 14 14 054 00 8	3.56



**Flex-jointed hose**

Suitable for KBM 50 Q, 50 U, 50 auto, 65 U when using twist drills.

Part number	£ List Price excl. VAT
3 14 14 070 01 0	14.18



**Cutting spray**

300 ml pump spray, for long tool life, optimum cutting performance and enhanced swarf flow.

Part number	£ List Price excl. VAT
3 21 32 031 00 0	16.08



**Cutting paste**

Lubricating agents for working on sheet metals.

Part number	£ List Price excl. VAT
3 21 32 020 12 9	15.48

**Other accessories**



**Magbrush**

Practical tool with high magnetic force for quick and easy collection of magnetic metal swarf.

Part number	£ List Price excl. VAT
6 42 01 005 01 0	49.78

**AKBU accessories**



**HighPower battery pack**

HighPower Li-ion battery with cells capable of handling high currents, charge status indicator and FEIN SafetyCell technology. Continually high power output with 75% higher current rating than a Li-ion battery. Recommended for FEIN cordless magnetic core drills and cordless angle grinders. Can be used with all FEIN 18 V cordless tools.

Current/ Voltages V	Capacity Ah	Part number	£ List Price excl. VAT
18	5,2	9 26 04 179 02 0	117.78



**HighPower battery starter set**

2 x HighPower Li-ion batteries with ALG 50 rapid charger.

Current/ Voltages V	Capacity Ah	Part number	£ List Price excl. VAT
18	5,2	9 26 04 307 01 0	281.40



**Cordless ALED 12-18 V LED lamp**

Compact and durable cordless LED lamp with swivel-mounted lamp head. Compatible with all 12 / 14 / 18 V FEIN Li-ion batteries, including hook for attaching the lamp. Extremely lightweight at 130 g and very bright at 900 Lux. Colour temperature is the equivalent of daylight. The brightness can be set to 2 levels.

Part number	£ List Price excl. VAT
9 26 04 200 02 0	56.59



**Quick charger ALG 50**

For all FEIN Li-ion batteries. Charge time from 35 min.

Part number	£ List Price excl. VAT
9 26 04 129 01 0	45.53



**Quick charger ALG 30**

For FEIN NiCd and Li-ion batteries. Charge time from 25 min.

Part number	£ List Price excl. VAT
9 26 04 096 01 0	163.10



	KBM 50 auto	KBM 80 auto	
	Lightweight, powerful and ingenious 2-speed auto magnetic core drill offering maximum efficiency and minimum physical strain for core drilling in the workshop and on the construction site.	High-performance, powerful and ingenious 3-speed automatic magnetic core drill with clockwise/anti-clockwise operation, MT3 tool mounting and fine adjustment offering maximum efficiency and minimum physical strain for core drilling in the workshop.	
<b>EAN 4014586...</b>			
<b>Page</b>	122	122	
<b>Application</b>	Core drilling in metal with a Ø up to 35 mm	▲▲	▲▲
	Core drilling in metal with a Ø up to 50 mm	▲▲	▲▲
	Core drilling in metal with a Ø up to 65 mm		▲▲
	Core drilling in metal with a Ø up to 80 mm		▲▲
	Twist drills with drill chuck (DIN 338)	▲	▲
	Twist drills with MK fitting (DIN 345)	▲▲	▲▲
	Tapping	▲▲	▲▲
	Countersinking	▲▲	▲▲
	Reaming	▲▲	▲▲
	Fully-automatic drilling	▲▲	▲▲
	Working one-handed	▲▲	▲▲
	Working overhead	▲	▲
<b>Equipment</b>	Installation work	▲▲	▲▲
	Workshop jobs	▲▲	▲▲
	Electronic magnetic holding force	●	●
	Magnetic holding force display	●	●
	Automatic drill feed	●	●
	Reversible rotation	●	●
	Variable speed control	●	●
	Memory function	●	●
	Speed-controlled electronics (tacho)	●	●
	Torque slipping clutch	●	●
<b>Technical features</b>	Input	1 200 W	2 000 W
	Output	610 W	900 W
	Speed, full load		
	1st gear	130 - 260 1/min	110 - 180 1/min
	2nd gear	260 - 520 1/min	160 - 260 1/min
	3rd gear		350 - 580 1/min
	Carbide core drill bit max. Ø	50 mm	80 mm
	HSS core drill max. Ø	40 mm	65 mm
	Core drill, drilling depth max.	50(75)* mm	50 mm
	Twist drill max. Ø	18/23** mm	18/32** mm
	Tapping	M 16**	M 27**
	Countersinking max. Ø	50** mm	50** mm
	Reaming max. Ø	23** mm	31** mm
	Core drill holder	QuickIN	QuickIN/QuickIN MAX
	Tool Holder	MK 3	MK 3
	Stroke	145 mm	145 mm
	Total stroke range	315 mm	285 mm
	Adjustment range for drill jigs		4,25 mm
	Swivel range for drill jigs		11°
	Magnetic holding power	12 500 N	18 000 N
Magnetic foot dimensions	195 x 90 mm	270 x 90 mm	
Cable with plug	4 m	4 m	
Weight according to EPTA	16,20 kg	26,40 kg	

Metal core drilling

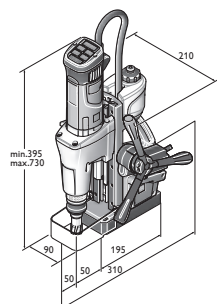

KBM 50 auto

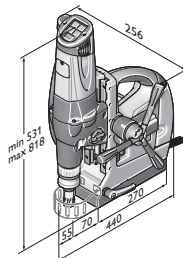

KBM 80 auto

- ▲ suitability
- ▲▲ optimal suitability
- included
- \* Also available with accessories.
- \*\* In manual tool mode only



Type	Part number	PC	£ List Price excl. VAT
<b>KBM 50 auto</b>	<b>7 270 42 61</b>	<b>01</b>	<b>2,587.00</b>

**Price includes:**

1 coolant tank, 1 lashing strap, 1 swarf hook, 1 centering pin, 1 drift key, 1 contact guard, 1 case

For accessories, see page 112



Type	Part number	PC	£ List Price excl. VAT
<b>KBM 80 auto</b>	<b>7 270 32</b>	<b>01</b>	<b>4,375.00</b>

**Price includes:**

1 QuickIN MAX/ MT3 tool mounting, 1 coolant tank, 1 lashing strap, 1 swarf hook, 2 centering pins, 1 drift key, 1 contact guard, 1 case

For accessories, see page 122

## Automatic

## Carbide core drill

**TCT Ultra 50 core bit with QuickIN MAX holder**

Very long service life and outstanding cutting performance. Metric dimensions, cutting depth 50 mm.

Bore Ø mm	Part number	£ List Price excl. VAT
50	6 31 27 330 01 0	96.79
51	6 31 27 331 01 0	109.73
52	6 31 27 332 01 0	109.73
53	6 31 27 333 01 0	106.95
54	6 31 27 334 01 0	106.95
55	6 31 27 335 01 0	106.95
56	6 31 27 336 01 0	111.47
57	6 31 27 337 01 0	111.47
58	6 31 27 338 01 0	111.47
59	6 31 27 339 01 0	111.47
60	6 31 27 340 01 0	111.47
61	6 31 27 341 01 0	126.14
62	6 31 27 342 01 0	126.14
63	6 31 27 343 01 0	126.14
64	6 31 27 344 01 0	126.14
65	6 31 27 345 01 0	126.14
66	6 31 27 346 01 0	144.71
67	6 31 27 347 01 0	144.71
68	6 31 27 348 01 0	144.71
69	6 31 27 349 01 0	144.71
70	6 31 27 350 01 0	159.82
71	6 31 27 351 01 0	161.34
72	6 31 27 352 01 0	162.85
73	6 31 27 353 01 0	164.36
74	6 31 27 354 01 0	165.88
75	6 31 27 355 01 0	167.37
76	6 31 27 456 01 0	174.92
77	6 31 27 457 01 0	176.44
78	6 31 27 458 01 0	178.67
79	6 31 27 459 01 0	180.98
80	6 31 27 460 01 0	180.98

## Adapter/drill chuck

**Adapter with QuickIN MAX holder**

QuickIN output

Part number	£ List Price excl. VAT
6 39 01 045 01 0	47.92

**Key-type drill chuck with QuickIN holder**

Chuck opening mm	Part number	£ List Price excl. VAT
1,5 - 13	6 39 01 023 02 0	74.97
1 - 16	6 39 01 023 01 1	88.88

## MT 3 drive arbors

**QuickIN output**

For retrofitting KBM 80 U / KBM 80 auto. With integrated cooling lubricant supply. For all QuickIN core bits with a Ø of 12 - 65 mm.

Part number	£ List Price excl. VAT
6 39 01 039 02 0	178.32

**QuickIN MAX output**

For retrofitting KBM 80 U / KBM 80 auto. With integrated cooling lubricant supply. For all FEIN QuickIN MAX core bits with a Ø of 50-80 mm.

Part number	£ List Price excl. VAT
6 39 01 038 02 0	261.27

**Weldon 32 Standard output**

Specially designed for core bits with cutting surfaces offset by 90°. Maximum cutting depth 50 mm.

Part number	£ List Price excl. VAT
6 39 01 041 01 0	308.56

**Weldon 32 output**

Clamping surfaces in line. Maximum cutting depth 75 mm.  
Specially designed for core bits from:

Mount	Part number	£ List Price excl. VAT
Hougen	6 39 01 042 01 0	302.72
Jancy	6 39 01 040 01 0	302.72

**Enlargement tapers**  
for M.T. sockets

Mount	Part number	£ List Price excl. VAT
MT 3/MT 3	6 33 04 005 00 0	178.32

**Thread cutting KBM 80****Tapping rapid change chuck for KBM 80**

can only be used for core drilling units with anti-clockwise rotation. Size 3, with QuickIN MAX holder, for thread drills (DIN 374/376), in conjunction with thread cutting inserts with or without M 22-M 27 safety clutch.

Part number	£ List Price excl. VAT
9 26 02 082 01 0	407.20

**Tapping Inserts**

for thread drills in accordance with DIN 374/376

Thread	Ø mm	Square mm	Part number	£ List Price excl. VAT
M22/M24	18	14,5	6 32 06 119 01 0	178.32
M 27	20	16	6 32 06 120 01 0	178.32

**Tapping Inserts**

with safety coupling for blind holes.  
for thread drills in accordance with DIN 374/376

Thread	Ø mm	Square mm	Part number	£ List Price excl. VAT
M22/M24	18	14,5	6 32 06 122 01 0	379.00
M 27	20	16	6 32 06 123 01 0	371.86

**Interchangeable reducing insert (WRE 3/2)**

Reducing insert for holding size 2 thread cutting inserts (M 6-M 20) in size 3 thread cutting quick change chuck. (9 26 02 082 01 0)

Part number	£ List Price excl. VAT
6 32 06 125 01 0	224.06

**Clamping fixtures****Vacuum plate**

for anti-magnetic materials and structured bases (corrugated sheet, stud plate etc.)  
396 x 350 x 95 mm for KBM 80 U, 80 auto.

Part number	£ List Price excl. VAT
9 26 02 085 01 0	539.97

**Vacuum pump**

Suction rate 0,015 m<sup>3</sup>/min, -0,8 bar, 92 W,  
weight 2,5 kg including suction hose

Part number	£ List Price excl. VAT
9 26 01 022 01 3	571.86

**Cooling****Pump**

Capacity approx. 450 ml. Suited to FEIN core drilling units KBM 32 Q, KBM 50 QX, KBM 52 U, KBM 65 Q, KBM 65 QF.

Part number	£ List Price excl. VAT
3 21 32 022 00 7	10.98

**Replacement hose**

for hand pump 3 21 32 022 00 7.

Part number	£ List Price excl. VAT
3 14 14 054 00 8	3.56

**Flex-jointed hose**

Suitable for KBM 50 Q, 50 U, 50 auto, 65 U when using twist drills.

Part number	£ List Price excl. VAT
3 14 14 070 01 0	14.18

**Cutting spray**

300 ml pump spray, for long tool life, optimum cutting performance and enhanced swarf flow.

Part number	£ List Price excl. VAT
3 21 32 031 00 0	16.08

**Cutting paste**

Lubricating agents for working on sheet metals.

Part number	£ List Price excl. VAT
3 21 32 020 12 9	15.48

**Other accessories****Magbrush**

Practical tool with high magnetic force for quick and easy collection of magnetic metal swarf.

Part number	£ List Price excl. VAT
6 42 01 005 01 0	49.78



## A clean finish: FEIN Dustex.

Dust extractors from the FEIN Dustex range are the ideal solution for minimising dust when working with power tools in industrial settings, in the workshop, or for assembly jobs. The convenient automatic on/off function switches these professional and exceptionally quiet wet/dry dust extractors on and off via the switch on the connected power tool. FEIN Dustex dust extractors also feature a soft start function which reduces the start-up current to avoid unnecessarily tripping lower rated fuses. The dust extractors are supplied with an extra-long power cable and a suction hose, giving the user maximum range and flexibility. FEIN Dustex safety extractors can reliably remove class M hazardous dusts.



---

### Wet / dry dust extractor

Page 126

For clean results and safe,  
healthy working conditions.



	Dustex 25 L set	Dustex 25 L	Dustex 35 L set	Dustex 35 L	Dustex 35 LX AC	Dustex 35 MX AC
	Compact, powerful wet and dry dust extractor for connecting to power tools when working in the workshop and for assembly work, with large accessory set.	Compact, powerful wet and dry dust extractor for connecting to power tools when working in the workshop and for assembly work.	Powerful wet and dry dust extractor for connecting to power tools when working in the workshop and for assembly work, with large accessory set.	Powerful wet and dry dust extractor for connecting power tools when working in the workshop and for assembly work.	Powerful, professional wet/dry dust extractor of dust class L with fully automatic filter cleaning for attachment of various case systems including extensive accessories.	Powerful, professional wet/dry dust extractor of dust class M with fully automatic filter cleaning for attachment of various case systems including extensive accessories.
<b>EAN 4014586...</b>						
<b>Page</b>	127	127	127	127	127	127
<b>Equipment</b>	Automatic start/stop	•	•	•	•	•
	Soft start	•	•	•	•	•
	Automatic filter cleaning					•
	Antistatic preparation					•
	Case storage					•
Dust class	L	L	L	L	L	M
<b>Technical features</b>	Maximum power input	1 380 W	1 380 W	1 380 W	1 380 W	1 380 W
	Air flow	4 320 l/min	4 320 l/min	4 320 l/min	4 320 l/min	4 320 l/min
	Max. vacuum	253 hPa	253 hPa	253 hPa	253 hPa	254 hPa
	Tank volume	22 l	22 l	32 l	32 l	35 l
	Weight according to EPTA	8,00 kg	8,00 kg	9,00 kg	9,00 kg	14,10 kg

- included

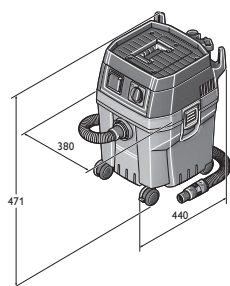

Dustex 25 L  
Dustex 25 L Set

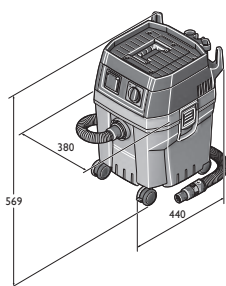

Dustex 35 L  
Dustex 35 L Set

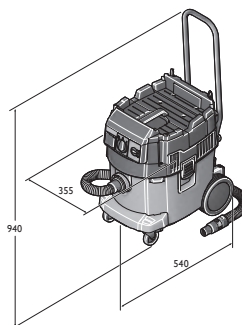

Dustex 35 LX AC

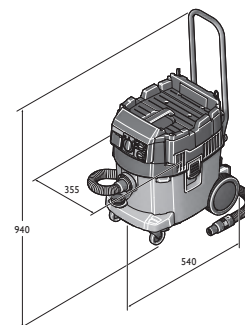

Dustex 35 MX AC





Type	Part number	PC	£ List Price excl. VAT
<b>Dustex 25 L set</b>	<b>9 20 27 060</b>	<b>01</b>	<b>POA</b>

**Price includes:**

1x 4 m suction hose, diameter 35 mm, 1 tool collar with suction force regulation, 1 Fleece filter bag, 1 Flat-fold filter, 2 suction pipes (metal), 1 combi nozzle with interchangeable inserts, 1 groove nozzle, 1 suction brush, 1 elbow

For accessories, see page 128



Type	Part number	PC	£ List Price excl. VAT
<b>Dustex 25 L</b>	<b>9 20 27 223</b>	<b>01</b>	<b>345.00</b>

**Price includes:**

1x 4 m suction hose, diameter 35 mm, 1 tool collar with suction force regulation, 1 Fleece filter bag, 1 Flat-fold filter

For accessories, see page 128



Type	Part number	PC	£ List Price excl. VAT
<b>Dustex 35 L set</b>	<b>9 20 28 060</b>	<b>01</b>	<b>POA</b>

**Price includes:**

1 tool collar with suction force regulation, 1 combi nozzle with interchangeable inserts, 1x 4 m suction hose, diameter 35 mm, 1 suction brush, 1 elbow, 2 suction pipes (metal), 1 groove nozzle, 1 Flat-fold filter, 1 Fleece filter bag

For accessories, see page 128



Type	Part number	PC	£ List Price excl. VAT
<b>Dustex 35 L</b>	<b>9 20 28 223</b>	<b>01</b>	<b>393.00</b>

**Price includes:**

1x 4 m suction hose, diameter 35 mm, 1 tool collar with suction force regulation, 1 Fleece filter bag, 1 Flat-fold filter

For accessories, see page 128



Type	Part number	PC	£ List Price excl. VAT
<b>Dustex 35 LX AC</b>	<b>9 20 30 060</b>	<b>01</b>	<b>726.00</b>

**Price includes:**

1 push bar, 1 PES flat fold filter, 1 disposal bag, 1x 4 m suction hose, diameter 35 mm, 1 tool collar with suction force regulation, 1 stepped collar, 2 suction pipes (metal), 1 combi nozzle with interchangeable inserts, 1 crevice nozzle, 1 suction brush, 1 elbow

For accessories, see page 128











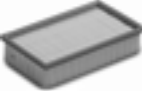

Type	Part number	PC	£ List Price excl. VAT
<b>Dustex 35 MX AC</b>	<b>9 20 32 060</b>	<b>01</b>	<b>909.00</b>

**Price includes:**

1 push bar, 1 PES flat fold filter, 1 disposal bag, 1x 4 m ES suction hose, diameter 35 mm, 1 tool collar with suction force regulation, 1 stepped collar, 2 suction pipes (metal), 1 combi nozzle with interchangeable inserts, 1 crevice nozzle, 1 suction brush, 1 elbow

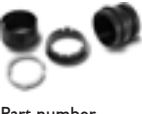
For accessories, see page 128

**General accessories**

	<b>Flat-fold filter</b> Cellulose, M dust class certification			
Part number		£ List Price	excl. VAT	
3 13 45 012 01 0				31.08
	<b>Flat-fold filter</b> PES, M dust class certification, superior filter			
Part number		£ List Price	excl. VAT	
3 13 45 059 01 0				59.64
	<b>Flat-fold filter</b> HEPA			
Part number		£ List Price	excl. VAT	
3 13 45 060 01 0				95.06
	<b>Suction hose</b>			
∅	L	Part number	£ List Price	excl. VAT
mm	m			
27	4	3 13 45 065 01 0		77.08
35	4	3 13 45 066 01 0		69.17
	<b>Suction hose</b> Electrostatically discharging, orange-black.			
∅	L	Part number	£ List Price	excl. VAT
mm	m			
27	4	3 13 45 121 01 0		172.74
35	4	3 13 45 120 01 0		172.74
	<b>Extension hose</b>			
∅	L	Part number	£ List Price	excl. VAT
mm	m			
27	2,5	3 13 45 067 01 0		70.85
35	2,5	3 13 45 068 01 0		58.42
	<b>Repair set</b> Suitable for 35 mm diameter suction hose			
Part number		£ List Price	excl. VAT	
3 13 45 069 01 0				31.08
	<b>Elbow</b>			
Part number		£ List Price	excl. VAT	
3 13 45 070 01 0				13.04
	<b>Elbow</b> with leak air aperture.			
∅	Part number	£ List Price	excl. VAT	
mm				
35	3 13 45 263 01 0			17.84
	<b>Suction tube</b> Metal version, pack of 2			
Part number		£ List Price	excl. VAT	
3 13 45 071 01 0				31.08

	<b>Floor nozzle</b> Reversible, with stainless steel sliding surface and all-round bristles. Suitable for hard floors and textile floor coverings		£ List Price	excl. VAT
Part number				
3 13 45 072 01 0				39.78
	<b>Combination nozzle</b> For wet and dry work with interchangeable inserts, rubber lips and brush strips		£ List Price	excl. VAT
Part number				
3 13 45 073 01 0				37.28
	<b>Aluminium combi nozzle</b> For wet and dry work with interchangeable inserts, rubber lips and brush strips		£ List Price	excl. VAT
Part number				
3 13 45 137 01 0				110.14
	<b>Crevice nozzle</b>		£ List Price	excl. VAT
Part number				
3 13 45 074 01 0				6.24
	<b>Upholstery nozzle</b> With brush strips		£ List Price	excl. VAT
Part number				
3 13 45 075 01 0				9.35
	<b>Suction brush,</b> can be rotated, with natural bristles, 70 x 45 mm bristle area		£ List Price	excl. VAT
Part number				
3 13 45 076 01 0				11.82
	<b>Intake brush</b> Natural bristles, 120 x 45 mm bristle area		£ List Price	excl. VAT
Part number				
3 13 45 077 01 0				21.00
	<b>Tool collar with suction force regulation</b> 38 mm diameter, power tool side		£ List Price	excl. VAT
Part number				
3 13 45 123 01 0				28.16
	<b>Tool collar with suction force regulation</b> Electrically conducting, diameter 27 mm, power tool side.		£ List Price	excl. VAT
Part number				
3 13 45 250 01 0				26.61
	<b>Stepped collar</b> 4 levels		£ List Price	excl. VAT
Part number				
3 13 45 079 01 0				13.94
	<b>Cable holder</b> to guide cable on suction hose, suitable for suction hose diameter of 27-35 mm		£ List Price	excl. VAT
No. in pack	Part number			
pcs				
5	3 13 45 119 01 0			6.81



**Accessory set**  
2 suction pipes (metal), 1 combi nozzle with interchangeable inserts, 1 crevice nozzle, 1 suction brush, 1 elbow

Part number	£ List Price excl. VAT
3 13 45 071 02 0	85.74



**Accessory set**  
1 suction hose, 2 suction pipes (metal), 1 combi nozzle with interchangeable inserts, 1 crevice nozzle, 1 suction brush, 1 elbow

Ø mm	Part number	£ List Price excl. VAT
40	3 13 45 133 02 0	86.93

### Accessories for Dustex 35 LX / MX



**Disposal bag**  
Open, recommended for AC models only

No. in pack pcs	Part number	£ List Price excl. VAT
5	3 13 45 063 01 0	33.53



**Premium fleece filter bag**  
Particularly strong, tear-resistant fleece with seams with additional reinforcement for fine, abrasive dusts. 2–3 times greater effective capacity than paper filter bags.

Model	No. in pack pcs	Part number	£ List Price excl. VAT
Dustex 35 L	5	3 13 45 251 01 0	51.94

### Accessories for FEIN Dustex 35 L



**Fleece filter bag**  
Particularly tear-resistant fleece. 2–3 times greater effective capacity than paper filter bags.

Model	No. in pack pcs	Part number	£ List Price excl. VAT
Dustex 35 L	5	3 13 45 062 01 0	32.31



**Premium fleece filter bag**  
Particularly strong, tear-resistant fleece with seams with additional reinforcement for fine, abrasive dusts. 2–3 times greater effective capacity than paper filter bags.

Model	No. in pack pcs	Part number	£ List Price excl. VAT
Dustex 35 L	5	3 13 45 251 01 0	51.94



**Permanent filter**  
Replaces the fleece filter bag

Part number	£ List Price excl. VAT
3 13 45 064 01 0	60.90



**HEPA filter bag**

No. in pack pcs	Part number	£ List Price excl. VAT
3	3 13 45 130 01 0	99.06

### Accessories for FEIN Dustex 25 L



**Fleece filter bag**  
Particularly tear-resistant fleece. 2–3 times greater effective capacity than paper filter bags.

Model	No. in pack pcs	Part number	£ List Price excl. VAT
Dustex 25 L	5	3 13 45 061 01 0	24.87



**Premium fleece filter bag**  
Particularly strong, tear-resistant fleece with seams with additional reinforcement for fine, abrasive dusts. 2–3 times greater effective capacity than paper filter bags.

Model	No. in pack pcs	Part number	£ List Price excl. VAT
Dustex 25 L	5	3 13 45 273 01 0	38.94



**Permanent filter**  
Replaces the fleece filter bag

Part number	£ List Price excl. VAT
3 13 45 064 01 0	60.90

### Accessories for Dustex II, Dustex 25, Dustex 40



**Filter bag**  
Extra fine version for higher levels of material separation, pack of 5

Model	Part number	£ List Price excl. VAT
Dustex II, 25	3 13 22 757 01 6	44.59
Dustex 40	3 13 22 811 01 0	96.98



**Filter bag**  
Standard version, pack of 5

Model	Part number	£ List Price excl. VAT
Dustex II, 25	3 13 22 781 01 7	26.11
Dustex 40	3 13 22 810 01 0	48.53



**Filter cartridge**

Part number	£ List Price excl. VAT
3 13 22 765 00 9	59.64



**Suction hose**  
Ø 36 mm, length 5 m

Part number	£ List Price excl. VAT
3 13 22 767 01 5	52.20



**Connecting piece**  
Universal device to connect power tools and accessories with dust extraction to vacuum cleaner. Flexible rubber sleeve, length 70 mm, inner diameter 31.5 mm.

Part number	£ List Price excl. VAT
3 13 22 771 00 9	5.59



**Stepped collar**  
for various connection diameters, e.g. for connecting up equipment from other manufacturers.

Part number	£ List Price excl. VAT
3 13 22 772 00 2	11.20



# Outstanding surface finishes for stainless steel, wood and paint.

When it comes to surface processing, only one factor counts: flawless results. Whether you're sanding or polishing, with the extensive range of FEIN power tools and specially designed professional sets you are in the best possible position to satisfy the exact specified requirements in surface finish. This is equally true for stainless steel machining, woodworking, interior fitting, renovation, vehicle or boat repairs and special vehicle construction. FEIN is the name you can count on: with powerful, virtually indestructible power tools, excellent ergonomics for minimum fatigue and maximum efficiency, and practical accessories – for perfect results. You will find more surface processing products in the chapters on Oscillation and Stationary Belt Grinders.



---

## Sanders

**Page****132**

The perfect tools for rough sanding and fine sanding of surfaces, pipes and profiles.

---

## Polishers

**Page****143**

Protecting and caring for sensitive and high-quality surfaces.



		MSf 636-1	RS 12-70 E	RS 12-70 E - Professional stainless steel set	WPO 14-25 E	WPO 14-25 E - Stainless steel start set
		Extremely powerful eccentric sander with optimum dust extraction for all surfaces.	Pipe sander with extremely high sanding capacity for stainless steel pipes and pipe bends up to 80 mm in diameter.	Stainless steel starter set for standard applications in pipe machining.	Extremely powerful sander/polisher for cool machining of stainless steel surfaces.	Stainless steel starter set for standard applications in surface machining.
<b>EAN 4014586...</b>			... 853819			
<b>Page</b>		134	134	134	134	134
<b>Application</b>	Rough sanding	▲▲	▲▲	▲▲	▲▲	▲▲
	Fine sanding	▲▲	▲▲	▲▲	▲▲	▲▲
	Dry sanding	▲▲	▲▲	▲▲	▲▲	▲▲
	Micro-sanding	▲▲	▲▲	▲▲	▲▲	▲▲
	polishing	▲	▲▲	▲▲	▲▲	▲▲
<b>Equipment</b>	FEIN high-power motor		●	●	●	●
	Suction	●				
	Spindle lock				●	●
	Restart protection		●	●	●	●
<b>Technical features</b>	Soft start		●	●	●	●
	Input	380 W	1 200 W	1 200 W	1 200 W	1 200 W
	Speed, no load	8 800 1/min	2 700 - 7 000 1/min	2 700 - 7 000 1/min	900 - 2 500 1/min	900 - 2 500 1/min
	Weight according to EPTA	2,40 kg	3,80 kg	3,80 kg	2,50 kg	2,50 kg
	Polishing disc Ø	150 mm			230 mm	230 mm
	Sanding pad Ø	150 mm			230 mm	230 mm
	Mounting thread	5/16"			M 14	M 14
	Belt speed		22 m/sek	22 m/sek		
Pipes up to Ø		8 - 80 mm	8 - 80 mm			

▲ suitability    ▲▲ optimal suitability    ● included

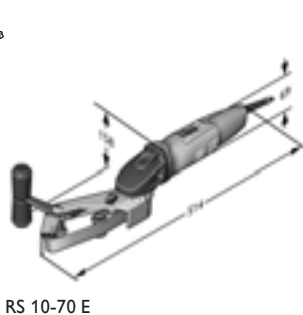
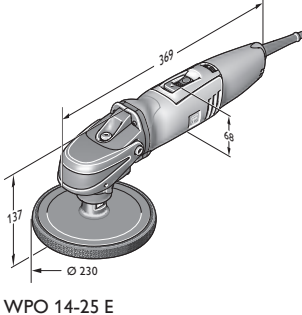
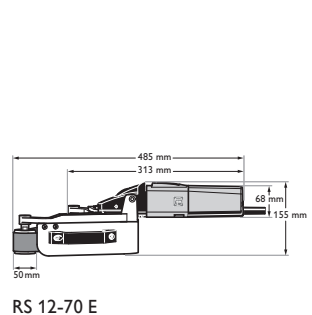
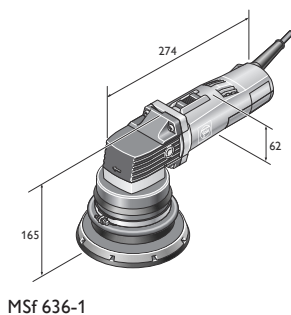



	ROT 14-200 E	RS 10-70 E Start set	KS 10-38 E set	WSG 17-70 Inox Start set	BF 10-280 E	BF 10-280 E Start set
	Extremely powerful rotary sander for high material removal on metal, wood, coatings and fibreglass-reinforced plastics (FRP).	Handy, compact pipe sander for stainless steel pipes with a diameter of up to Ø 45 mm.	Fillet weld grinder for difficult-to-reach spots in metal constructions.	Stainless steel starter set for preparing to finish surfaces, pipes and profiles.	Extremely powerful belt file for corners and edges in stainless steel machining.	Start set belt file for corners and edges in stainless steel machining.
			... 868936			
	134	134	134	135	135	135
	▲▲	▲▲	▲▲	▲▲	▲▲	▲▲
		▲▲	▲▲	▲▲	▲▲	▲▲
	▲▲	▲▲	▲▲	▲▲	▲▲	▲▲
		▲▲	▲▲	▲▲	▲▲	▲▲
	▲	▲▲	▲▲	▲▲	▲▲	▲▲
	●	●	●	●	●	●
				●		
		●	●	●	●	●
		●	●	●	●	●
	1 200 W	800 W	800 W	1 700 W	800 W	800 W
	900 - 2 500 1/min	2 500 - 7 000 1/min	1 350 - 3 750 1/min	2 700 - 8 500 1/min	10 000 - 28 000 1/min	10 000 - 28 000 1/min
	2,60 kg	2,90 kg	3,20 kg	2,40 kg	2,10 kg	2,10 kg
	200 mm			125 mm		
	200 mm			125 mm		
	M 14			M 14		
		3.5 - 11 m/sek			12 - 32 m/sek	12 - 32 m/sek
		8 - 45 mm				

Surface processing

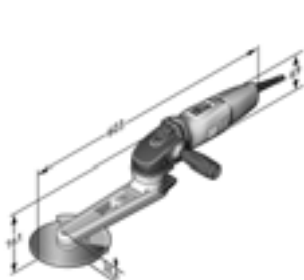

KS 10-38 E Set

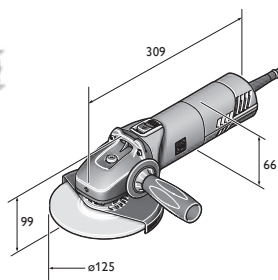

WSG 17-70

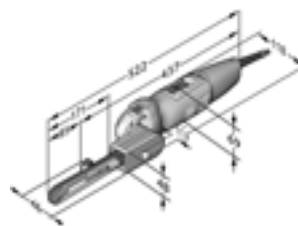

BF 10-280 E



Type	Part number	PC	£ List Price excl. VAT
<b>MSf 636-1</b>	<b>7 220 78</b>	<b>01</b>	<b>759.00</b>

**Price includes:**  
1 eccentric head Ø 150 mm, 1 backing pad, medium, Ø 150 mm, 1 suction wheel guard, 1 set of keys  
For accessories, see page 135



Type	Part number	EAN	PC	£ List Price excl. VAT
<b>RS 12-70 E*</b>	<b>7 221 13 50 01 4</b>	<b>4014586853819</b>	<b>01</b>	<b>1,439.00</b>

For accessories, see page 135  
\* 230 V only



Type	Part number	PC	£ List Price excl. VAT
<b>RS 12-70 E – Professional stainless steel set</b>	<b>7 221 13 51</b>	<b>01</b>	<b>1,767.00</b>

**Price includes:**  
2 x 10 pcs. polishing belts, 20 x 815 mm P120/P180, 2 x 10 pcs. polishing belts, 40 x 815 mm P120/P180, 5 fleece belts 20 x 820 mm very fine, 1 plastic carrying case  
For accessories, see page 135



Type	Part number	PC	£ List Price excl. VAT
<b>WPO 14-25 E</b>	<b>7 221 49 24</b>	<b>01</b>	<b>546.00</b>

**Price includes:**  
1 anti-vibration handle  
For accessories, see page 135



Type	Part number	PC	£ List Price excl. VAT
<b>WPO 14-25 E – Stainless steel start set</b>	<b>7 221 49 50</b>	<b>01</b>	<b>961.00</b>

**Price includes:**  
1 holder, rotating, safety guard, 1 work arbour, 1 corrugated sanding fleece, 1 supporting plate with velcro adhesion section (Ø 115 mm, M14), 10 sanding fleeces with velcro (Ø 115 mm, fine), 1 elastic sanding roller (100 x 100 mm, grain 60), 1 lamella fleece cylinder (100 x 100 mm, grain 180), 2 keys, 1 anti-vibration handle, 1 plastic carrying case  
For accessories, see page 135



Type	Part number	PC	£ List Price excl. VAT
<b>ROT 14-200 E</b>	<b>7 221 65 5</b>	<b>01</b>	<b>754.00</b>

**Price includes:**  
1 Extractor hood, 1 backing pad, hard, Ø 200 mm, 1 anti-vibration handle, 1 plastic carrying case  
For accessories, see page 135



Type	Part number	PC	£ List Price excl. VAT
<b>RS 10-70 E Start set</b>	<b>7 221 66 60</b>	<b>01</b>	<b>1,412.00</b>

**Price includes:**  
10 each of grinding belts (grit 120, 180), 5 fleece belts (fine), 1 plastic carrying case  
For accessories, see page 135



Type	Part number	EAN	PC	£ List Price excl. VAT
<b>KS 10-38 E set*</b>	<b>7 221 67 60 00 0</b>	<b>4014586868936</b>	<b>01</b>	<b>984.00</b>

**Price includes:**  
1 anti-vibration handle, Medium fleece discs, diameter 150 mm, one 3 mm thick and one 6 mm thick, Fine fleece discs, diameter 150 mm, one 3 mm thick and one 6 mm thick, Profiling stone for profiling the fleece discs, 1 plastic carrying case  
For accessories, see page 135  
\* 230 V only





Type	Part number	PC	£ List Price excl. VAT
<b>WSG 17-70 Inox Start set</b>	<b>7 222 13 61</b>	<b>19</b>	<b>POA</b>

**Price includes:**

1 serrated sanding disc, medium, 1 finishing disc (diameter 125 mm), 5 each of Pyramix sanding sheet, perforated, diameter 115 mm (grit 280, 400, 800), 25 sanding sheets (grit 80, diameter 115 mm), 1 cooling backing pad (diameter 75 mm, M14), 1 supporting plate with velcro adhesion section (Ø 115 mm, M14), 1 plastic carrying case

For accessories, see page 135



Type	Part number	PC	£ List Price excl. VAT
<b>BF 10-280 E</b>	<b>7 228 05 50</b>	<b>01</b>	<b>685.00</b>

**Price includes:**

1 stepped grinding arm

For accessories, see page 135



Type	Part number	PC	£ List Price excl. VAT
<b>BF 10-280 E Start set</b>	<b>7 228 05 51</b>	<b>01</b>	<b>808.00</b>

**Price includes:**

3 grinding arms (1 each of 3/6 mm stepped, 6 mm straight, 20 mm straight), 10 grinding belts, 3 mm (grit 120), 10 grinding belts, 6 mm (grit 120), 10 grinding belts, 20 mm (grit 120), 5 fleece belts, 6 mm (medium), 1 plastic carrying case

For accessories, see page 135

**Sanders**

**General accessories**



**anti-vibration handle**

M 8, vibration absorbing, to reduce the vibrations during longer jobs.

Part number	£ List Price excl. VAT
3 21 19 124 01 0	9.75



**Tool case**

Plastic, inner dimensions: 470 x 275 x 116 mm

Part number	£ List Price excl. VAT
3 39 01 118 01 0	46.09



**Plastic box**

Box insert with lockable lid for small parts and accessories, suitable for tool box 3 39 01 118 01 0, max 5 items/box.

Part number	£ List Price excl. VAT
3 39 01 119 00 0	4.54



**Tool case**

Plastic, inner dimensions: 470 x 275 x 232 mm

Part number	£ List Price excl. VAT
3 39 01 122 01 0	71.38



**Pre-polishing cream, red**  
for pre-polishing

Part number	£ List Price excl. VAT
6 37 26 008 01 2	29.69



**Colouring paste, white**

for buffing and high-gloss polishing

Part number	£ List Price excl. VAT
6 37 26 009 01 6	29.69



**Microfibre cloth**

Fine weave quality for cleaning polishing residue. Hem-free version means no scratches and no lint

Part number	£ List Price excl. VAT
6 37 33 003 01 0	8.26



**Stainless steel masking tape**

To protect stainless steel surfaces from scratches when sanding. Perfect for use with grinding of mitre joints on welded stainless steel profiles. The covered side is protected by masking tape when sanding, satin-finishing or matting.

L m	Part number	£ List Price excl. VAT
5	6 37 33 010 01 0	57.83

**Accessories for RS 12-70 E**



**Basic pipe sander set**

Cleaning off dirt, removing scratches and achieving a perfect satin finish. Consisting of: 2 x 10 grinding belts, 20 x 815 mm, P 120/P180; 2 x 10 grinding belts, 40 x 815 mm, P120/P180; 5 fleece belts, 20 x 820 mm, very fine 280

Part number	£ List Price excl. VAT
6 37 14 050 02 1	225.93



**Pipe sander polishing set**

From preparing to polish to achieving a perfect mirror polish. Consisting of: 2 x 10 grinding belts, 20 x 815 mm, P320/P400; 1 x 3 polishing belts, 20 x 815 mm; 1 tube pre-polishing cream, red (200ml); 1 tube colouring paste, white (200ml)

Part number	£ List Price excl. VAT
6 37 14 052 02 3	185.56



**Ceramic sanding belts**

Maximum material removal and very long service life. Also suitable for removing fine welded seams

Grain	Dimensions mm	No. in pack pcs	Part number	£ List Price excl. VAT
80	20 x 815	10	6 37 14 130 01 0	49.05
80	40 x 815	10	6 37 14 131 01 0	77.04



**Grinding belts**

Highly flexible sanding belts, ideal for sanding pipe bends  
20 x 815 mm

Grain	No. in pack pcs	Part number	£ List Price excl. VAT
120	10	6 37 14 050 01 5	34.04
180	10	6 37 14 051 01 4	34.04
320	10	6 37 14 052 01 7	34.04
400	10	6 37 14 053 01 1	34.04



**Grinding belts**

Highly flexible sanding belts, ideal for sanding pipe bends  
40 x 815 mm

Grain	No. in pack pcs	Part number	£ List Price excl. VAT
120	10	6 37 14 054 01 9	55.88
180	10	6 37 14 055 01 3	55.88



**Fleece strips**

Very soft version for smooth surfaces, even with tight pipe bends  
20 x 815 mm

Grain	No. in pack pcs	Part number	£ List Price excl. VAT
80	5	6 37 14 056 01 6	39.30
120	5	6 37 14 057 01 0	39.30
280	5	6 37 14 058 01 8	46.06



**Polishing belts**

20 x 815 mm, very soft version, for smooth mirror polish even with tight pipe bends

Part number	£ List Price excl. VAT
6 37 26 010 01 8	66.60



**Rotating roller**

For narrow spaces (distance from wall 50 mm)

Part number	£ List Price excl. VAT
3 13 35 017 01 1	77.48

**Accessories for BF 10-280 E**



**Stepped grinding arm**

Belt width mm	Part number	£ List Price excl. VAT
3/6	6 38 10 026 01 0	72.39



**Straight grinding arm**

Belt width mm	Part number	£ List Price excl. VAT
6	6 38 10 027 01 0	72.39
20	6 38 10 030 01 0	94.63



**Ceramic grinding belt**

Maximum material removal and very long service life. Also suitable for removing fine welded seams  
Pack of 10, 520 mm long.

Grain	Width mm	Part number	£ List Price excl. VAT
80	3	6 37 14 061 01 0	15.18
120	3	6 37 14 062 01 0	15.18
180	3	6 37 14 063 01 0	15.18
80	6	6 37 14 068 01 0	16.83
120	6	6 37 14 069 01 0	16.83
180	6	6 37 14 070 01 0	16.83
80	20	6 37 14 089 01 0	23.20
120	20	6 37 14 090 01 0	23.20
180	20	6 37 14 091 01 0	23.20



**Fleece belt**

Soft version for smooth surfaces.  
Pack of 5, 520 mm long.

Width mm	Model	Part number	£ List Price excl. VAT
6	course	6 37 14 114 01 0	21.45
6	medium	6 37 14 115 01 0	21.45
6	fine	6 37 14 116 01 0	21.45
20	course	6 37 14 123 01 0	30.23
20	medium	6 37 14 124 01 0	30.23
20	fine	6 37 14 125 01 0	30.23



**Polishing belt**

Soft version, for a smooth mirror polish in conjunction with FEIN polishing pastes.  
Pack of 3, 520 mm long.

Width mm	Part number	£ List Price excl. VAT
6	6 37 26 016 01 0	13.79
20	6 37 26 019 01 0	19.00

**Accessories for WSG 17-70 Inox**



**Quick-clamping nut**

to change discs without need for tool, low height of just 8 mm

Part number	£ List Price excl. VAT
6 38 02 191 01 0	30.65



**Work gloves**

Vibration-attenuating, certified according to EN 388/420, EN ISO 10819, EEC No. 0200, No. in pack 1 pair

Size	Part number	£ List Price excl. VAT
9 L	3 21 73 003 00 3	100.18
10 XL	3 21 73 004 00 1	100.18
11 XXL	3 21 73 005 00 5	100.18



**Wheel guard**

for serrated and roughing discs

Ø mm	Part number	£ List Price excl. VAT
125	3 18 10 300 00 0	10.51



**Safety hood for cutting work**

for safe working with cutting wheels

Ø mm	Part number	£ List Price excl. VAT
125	6 38 11 017 01 0	31.31



**Inner flange**

Part number	£ List Price excl. VAT
6 38 01 182 01 0	8.20



**Threaded flange**

M 14, for flexible grinding/cutting discs, fan-pattern grinding wheels and round brush

Part number	£ List Price excl. VAT
6 38 02 052 00 0	8.20



**Threaded flange**

M 14, for elastic backing pad and for twisted steel wire brush

Part number	£ List Price excl. VAT
6 38 01 154 00 7	7.65



**Elastic backing pad**

with flange M 14, for fibre sanding sheets Ø 125 mm

Ø mm	Part number	£ List Price excl. VAT
125	6 38 06 087 01 3	6.40



**Backing pad**

M 14, Ø 125 mm, with Velcro attachment, for sanding sheets with Velcro rapid attachment

Ø mm	Part number	£ List Price excl. VAT
115	6 38 06 168 01 2	11.83



**Backing pad**

with Velcro attachment, for working with sanding fleece, M 14

Ø mm	Part number	£ List Price excl. VAT
115	6 38 06 172 01 0	16.02



**Fleece sanding discs**

Ø 115 mm, with Velcro attachment, for use with support plate  
6 38 06 172 01 0

Model	No. in pack pcs	Part number	£ List Price excl. VAT
course	10	6 37 32 001 01 8	39.28
medium	10	6 37 32 002 01 1	37.33
fine	10	6 37 32 003 01 5	31.98



**Cool sanding pad**

Rear-ventilated backing pad, ideal for Pyramix sanding discs

Ø mm	Part number	£ List Price excl. VAT
115	6 38 06 193 01 0	12.78



**Cool sanding pad**

Rear-ventilated backing pad, ideal for Pyramix sanding discs for use when the outer edge of the sanding discs has been removed.

Ø mm	Part number	£ List Price excl. VAT
75	6 38 06 196 01 0	12.55



**Sanding sheets**

Ø 115 mm, for removing very deep scratches and fine welded seams

Grain	No. in pack pcs	Part number	£ List Price excl. VAT
80	25	6 37 28 135 01 0	27.03



**Pyramix sanding sheet**

The Pyramix hook and loop sanding disc features a new perforation pattern which means it can now also be used after the first edge has been worn away. Ø 115 mm. For removing deep scratches

Grain	No. in pack pcs	Part number	£ List Price excl. VAT
280	5	6 37 17 239 01 0	24.54
280	25	6 37 17 239 02 0	116.89



**Pyramix sanding sheet**

The Pyramix hook and loop sanding disc features a new perforation pattern which means it can now also be used after the first edge has been worn away. Ø 115 mm. For removing minor scratches, creating sanding pattern, reducing roughness depth

Grain	No. in pack pcs	Part number	£ List Price excl. VAT
400	5	6 37 17 240 01 0	24.54
400	25	6 37 17 240 02 0	116.89



**Pyramix sanding sheet**

The Pyramix hook and loop sanding disc features a new perforation pattern which means it can now also be used after the first edge has been worn away. Ø 115 mm. For removing very minor scratches, creating sanding pattern, reducing roughness depth

Grain	No. in pack pcs	Part number	£ List Price excl. VAT
800	5	6 37 17 241 01 0	26.56
800	25	6 37 17 241 02 0	114.67



**Pyramix sanding sheet**

The Pyramix hook and loop sanding disc features a new perforation pattern which means it can now also be used after the first edge has been worn away. Ø 115 mm. Reducing roughness depth, optimum preconditions for subsequent polishing

Grain	No. in pack pcs	Part number	£ List Price excl. VAT
1400	5	6 37 17 242 01 0	24.54
1400	25	6 37 17 242 02 0	116.89



**Flap wheel**

diameter 125 mm, M 14

Grain	Part number	£ List Price excl. VAT
120	6 37 21 052 01 0	27.24



**Finishing disc**

Ø 125 mm, for final finish

Part number	£ List Price excl. VAT
6 37 32 005 01 0	28.12



**Serrated sanding disc**

For removing welded seams without damaging adjacent surfaces. Depending on the thickness of the welded seam, the user can choose between serrated sanding discs.

Ø mm	Model	No. in pack pcs	Part number	£ List Price excl. VAT
125	soft	5	6 37 30 019 01 0	93.57
125	medium	5	6 37 30 021 01 0	93.57
125	medium	10	6 37 30 018 01 0	195.91
125	course	5	6 37 30 020 01 0	93.57



**Stainless steel set for grinding pipes / profiles**  
Sand fine welded seams without damaging adjacent surfaces. With subsequent surface finish. Consisting of: 10 x medium serrated grinding discs (6 37 30 018 01 0), 1 flap wheel, grit 120 (6 37 21 052 01 0), 1 finishing disc (6 37 32 005 01 0).

Part number	£ List Price excl. VAT
6 37 21 052 02 0	248.18



**Stainless steel set - Preparing to polish surfaces / pipes / profiles**  
Quickly and effectively removes scratches; optimum preparation for polishing with matched sanding pattern; when preparing for polishing: effective material removal in little time. Consisting of: 5 Pyramix sanding sheets, grit 280 (6 37 17 239 01 0), 5 Pyramix sanding sheets, grit 400 (6 37 17 240 01 0), 5 sanding sheets, grit 800 (6 37 17 241 01 0), 5 Pyramix sanding sheets, grit 1400 (6 37 17 242 01 0), 1 cooling backing pad, Ø 75 mm (6 38 06 196 01 0), 25 sanding sheets, grit 80 (6 37 28 135 01 0), 1 cooling backing pad, Ø 115 mm (6 38 06 193 01 0)

Part number	£ List Price excl. VAT
6 38 06 193 04 0	151.68



**Felt serrated disc**  
For polishing and pre-polishing stainless steel. Because of the lamella, the felt doesn't "burn" and polishing without streaks is possible. Only use with polishing paste (pre-polishing = pre-polishing paste, high-gloss polishing = colouring paste).

Ø mm	Model	Part number	£ List Price excl. VAT
125	soft	6 37 23 037 01 0	29.39
125	medium	6 37 23 038 01 0	29.39

**Accessories for KS 10-38 E**



**Fleece disc**  
Very high sanding capacity for sanding, descaling and satin-finishing fillet welds.

Ø mm	Thickness mm	Model	Part number	£ List Price excl. VAT
150	7	very course	6 37 34 008 01 0	34.21



**Fleece disc**  
With a high sanding capacity for sanding, descaling and satin-finishing fillet welds.

Ø mm	Thickness mm	Model	Part number	£ List Price excl. VAT
150	3	course	6 37 34 001 01 0	31.75
150	6	course	6 37 34 002 01 0	39.88



**Fleece disc**  
For sanding, levelling, descaling and fine satin-finishing of fillet welds. Removes scratches on profiles and surfaces with ease.

Ø mm	Thickness mm	Model	Part number	£ List Price excl. VAT
150	3	medium	6 37 34 003 01 0	23.68
150	6	hard	6 37 34 004 01 0	29.02



**Fleece disc**  
Removes tarnishing and minor scratches, ideal for preparing to polish fillet welds.

Ø mm	Thickness mm	Model	Part number	£ List Price excl. VAT
150	3	fine	6 37 34 005 01 0	23.68
150	6	fine	6 37 34 006 01 0	29.02



**Fleece disc**  
For pre-polishing surfaces of fillet welds. Quickly removes tarnishing without wearing away the welded seam.

Ø mm	Thickness mm	Model	Part number	£ List Price excl. VAT
150	6	very fine	6 37 34 007 01 0	25.67



**Felt disc**  
For polishing fillet welds to a mirror polish in conjunction with FEIN polishing paste.

Ø mm	Thickness mm	Part number	£ List Price excl. VAT
150	6	6 37 18 011 01 0	16.60



**Profiling stone**  
For sanding the fleece discs for even fillet weld profiles.

Part number	£ List Price excl. VAT
6 37 19 011 01 0	20.95

**Accessory RS 10-70 E**



**Grinding belts**  
Highly flexible sanding belts, ideal for sanding pipe bends  
No. in pack 10, 30 x 533 mm.

Grain	Part number	£ List Price excl. VAT
80	6 37 14 136 01 0	27.15
120	6 37 14 137 01 0	27.15
180	6 37 14 138 01 0	27.15
320	6 37 14 139 01 0	26.61
400	6 37 14 140 01 0	26.61



**Fleece strips**  
Very soft version for smooth surfaces, even with tight pipe bends  
No. in pack 5, 30 x 533 mm.

Model	Part number	£ List Price excl. VAT
course	6 37 14 141 01 0	37.15
medium	6 37 14 142 01 0	37.15
fine	6 37 14 143 01 0	37.15



**Polishing belts**  
Very soft version for smooth mirror polish, even with tight pipe bends.  
No. in pack 3, 30 x 533 mm.

Part number	£ List Price excl. VAT
6 37 14 144 01 0	21.59



**Accessories for ROT 14-200 E**



**Protect.suction hood**

Part number	£ List Price excl. VAT
3 18 10 264 01 0	21.39

**Protect.suction hood**

Part number	£ List Price excl. VAT
3 18 10 240 01 4	27.07



**Connecting piece**

Universal device to connect power tools and accessories with dust extraction to vacuum cleaner. Flexible rubber sleeve, length 70 mm, inner diameter 31.5 mm.

Part number	£ List Price excl. VAT
3 13 22 771 00 9	5.59



**Sanding sheets**

perforated, Ø 150 mm, with Velcro rapid attachment  
Application: Wood, metal, car bodies, welds. Quality: fully synthetic-resin bonded, corundum. Features: high sanding capacity.

Grain	No. in pack pcs	Part number	£ List Price excl. VAT
60	50	6 37 28 022 01 7	57.37



**Sanding pad**

Ø 150 mm, with holes, with hook and loop fastener

Model	Part number	£ List Price excl. VAT
hard	6 38 06 116 02 1	108.25
extra soft	6 38 06 166 02 6	106.54



**Sanding pad**

Ø 200 mm, with holes, with hook and loop fastener

Model	Part number	£ List Price excl. VAT
hard	6 38 06 102 02 3	120.14
medium	6 38 06 095 02 1	119.74
extra soft	6 38 06 118 02 3	119.74



**Lambskin**

with Velcro rapid attachment.

Ø mm	Part number	£ List Price excl. VAT
150	6 37 23 009 00 4	11.06
200	6 37 23 010 00 6	18.54

**Accessories for MSf 636-1**

**Hook and loop fastener**

Ø 150 mm

Ø mm	Part number	£ List Price excl. VAT
150	3 14 26 030 00 5	18.08

**Sanding pad**

Ø 115 mm, without holes, with hook and loop fastener, hard

Part number	£ List Price excl. VAT
6 38 06 167 02 0	39.19



**Sanding sheets**

Ø 115 mm, for removing very deep scratches and fine welded seams

Grain	No. in pack pcs	Part number	£ List Price excl. VAT
80	50	6 37 28 096 01 9	27.03



**Sanding pad**

Ø 125 mm, perforated, with hook and loop fastening

Model	Part number	£ List Price excl. VAT
hard	6 38 06 103 02 7	74.40
medium	6 38 06 088 02 7	75.44
soft	6 38 06 117 02 5	96.29

**Sanding sheets**

perforated, Ø 125 mm, with Velcro rapid attachment  
Application: wood, paints, filler, automotive paints, fibreglass, plastics. Quality: fully synthetic-resin bonded, medium bond, corundum. Feature: greatly reduces glazing, high sanding capacity, flexible.

Grain	No. in pack pcs	Part number	£ List Price excl. VAT
80	50	6 37 28 001 01 6	38.02
100	50	6 37 28 002 01 9	38.02



**Sanding pad**

Ø 150 mm, with holes, with hook and loop fastener

Model	Part number	£ List Price excl. VAT
hard	6 38 06 101 02 0	96.76
medium	6 38 06 090 02 3	98.65
soft	6 38 06 114 02 4	90.75



**Eccentric head**

Ø 150 mm

Part number	£ List Price excl. VAT
3 12 07 103 01 3	121.76



**Sanding sheets**

perforated, Ø 150 mm, with Velcro rapid attachment  
Application: Metal, car bodies, soldered points, welds, fibreglass. Quality: high-performance emery canvas, fully synthetic-resin bonded, corundum. Features: highly stable, high sanding capacity.

Grain	No. in pack pcs	Part number	£ List Price excl. VAT
40	50	6 37 28 009 01 4	107.11
60	50	6 37 28 010 01 6	99.15
80	50	6 37 28 056 01 3	90.10
100	50	6 37 28 054 01 6	91.00

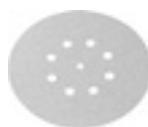

**Sanding sheets**

perforated, Ø 150 mm, with Velcro rapid attachment  
Application: wood, paint, automotive paints, filler, fibreglass, plastics. Quality: fully synthetic-resin bonded, corundum. Feature: greatly reduces glazing, flexible.

Grain	No. in pack pcs	Part number	£ List Price excl. VAT
80	50	6 37 28 074 01 4	49.87
120	50	6 37 28 084 01 3	42.91
150	50	6 37 28 012 01 8	42.91
180	50	6 37 28 013 01 2	42.91
220	50	6 37 28 014 01 0	43.38
240	50	6 37 28 015 01 4	42.91
320	50	6 37 28 017 01 1	42.91
400	50	6 37 28 061 01 0	43.38

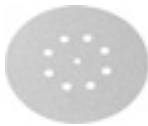

**Sanding sheets**

perforated, Ø 150 mm, with Velcro rapid attachment  
 Application: Wood, metal, car bodies, welds.  
 Quality: fully synthetic-resin bonded, light bond, corundum.  
 Features: high sanding capacity.

Grain	No. in pack pcs	Part number	£ List Price excl. VAT
40	50	6 37 28 072 01 2	52.97
60	50	6 37 28 073 01 6	50.89



**Lambskin**

with Velcro rapid attachment.

Ø mm	Part number	£ List Price excl. VAT
125	6 37 23 008 00 0	8.61
150	6 37 23 009 00 4	11.06

**Accessories for WPO 14-25 E**



**Standard stainless steel set for surfaces**

Set for standard applications in surface machining: cleaning off dirt with corrugated fleece, removing tarnishing and achieving a high-quality satin finish. Consisting of: 1 elastic sanding cylinder, grit 60 (6 37 21 006 01 2), 1 lamella fleece cylinder (6 37 21 009 01 8), 1 corrugated sanding fleece (6 37 23 021 01 3), 1 fine fleece sanding disc, pack of 10 (6 37 32 003 01 5), 1 support plate (6 38 06 172 01 0), 1 work arbour (6 38 03 066 02 4), 1 pin-type face spanner (6 29 10 022 00 2), 1 open-ended spanner 19 x 22 (6 29 04 003 00 0)

Part number	£ List Price excl. VAT
6 37 21 006 04 0	219.53



**Stainless steel set for grinding surfaces**

Effective material removal for surfaces. Consisting of: 1 expansion cylinder (6 38 06 192 01 0), 5 sanding sleeves, grit 60 (6 37 14 132 01 0), 5 sanding sleeves, grit 80 (6 37 14 133 01 0), 5 sanding sleeves, grit 120 (6 37 14 134 01 0)

Part number	£ List Price excl. VAT
6 38 06 192 02 0	221.09



**Stainless steel set for satin-finishing surfaces**

Perfect smooth satin finish. Very low build-up of heat during machining. Consisting of: 1 medium elastic sanding cylinder, grit 60 (6 37 21 006 01 2), 1 fine elastic sanding cylinder, grit 180 (6 37 21 007 01 6), 1 fine sine fleece sanding cylinder, grit 180 (6 37 21 051 01 0)

Part number	£ List Price excl. VAT
6 37 21 050 02 0	235.37



**Standard stainless steel set for pipes**

Set for standard applications in the machining of straight pipes. Cleaning off dirt, removing tarnishing and achieving a high-quality satin finish. Consisting of: 1 grinding belt roller (6 38 06 181 01 6), 1 grinding belt, grit 60, pack of 10 (6 37 14 044 01 0), 1 grinding belt, grit 120, pack of 10 (6 37 14 045 01 4), 1 medium fleece belt (6 37 14 048 01 9), 1 fine fleece belt (6 37 14 049 01 3), 1 adhesive strip (6 38 09 004 01 9)

Part number	£ List Price excl. VAT
6 38 06 181 03 0	155.95



**Stainless steel set - Satin-finishing profiles**

Satin-finishing of profiles for a perfect sanding pattern. Consisting of: 1 elastic cylinder, grit 60, medium (6 37 21 054 01 0), 1 elastic cylinder, grit 180, fine (6 37 21 055 01 0), 1 sine fleece sanding cylinder, fine (6 37 21 056 01 0), 1 work arbour (6 38 03 071 02 0)

Part number	£ List Price excl. VAT
6 37 21 054 02 0	193.42



**Stainless steel set for polishing surfaces / pipes / profiles**

Polishing surfaces to a mirror polish. No lint build-up on the polishing rings. Consisting of: 1 sisal polishing ring (6 37 23 011 01 4), 2 rigid polishing ring cloths (6 37 23 013 01 1), 2 soft polishing ring cloths (6 37 23 014 01 9), 1 brush paste (6 37 26 027 01 0), 1 pre-polishing paste (6 37 26 028 01 0), 1 colouring paste (6 37 26 029 01 0), 1 work arbour (6 38 03 027 03 8), 1 pin-type face spanner (6 29 10 022 00 2), 1 open-ended spanner 19 x 22 (6 29 04 003 00 0)

Part number	£ List Price excl. VAT
6 37 23 011 04 0	122.77



**Elastic sanding cylinder**

Bore 19 mm  
 100 x 100 mm

Grain	Model	Part number	£ List Price excl. VAT
60	medium	6 37 21 006 01 2	95.00
180	fine	6 37 21 007 01 6	95.00



**Elastic sanding cylinder**

Bore 19 mm  
 100 x 50 mm

Grain	Model	Part number	£ List Price excl. VAT
60	medium	6 37 21 054 01 0	66.05
180	fine	6 37 21 055 01 0	66.05



**Sine fleece sanding cylinder**

Bore 19 mm  
 Ø 100 x 50 mm, with sine wave, for smooth satin finish

Grain	Model	Part number	£ List Price excl. VAT
180	fine	6 37 21 056 01 0	38.28



**Sine fleece sanding cylinder**

Bore 19 mm  
 Ø 100 x 100 mm, with sine wave, for smooth satin finish

Grain	Model	Part number	£ List Price excl. VAT
180	fine	6 37 21 051 01 0	54.22



**Flap wheel**

diameter 150 mm, bore 14 mm  
 For remedying minor mistakes and scratches

Part number	£ List Price excl. VAT
6 37 21 003 01 7	61.19



**Flap wheel**

diameter 150 mm, bore 14 mm  
 for medium brush applications

Part number	£ List Price excl. VAT
6 37 21 004 01 5	61.19



**Flap wheel**

diameter 150 mm, bore 14 mm  
 For for fine brush strokes, satin finish.

Part number	£ List Price excl. VAT
6 37 21 005 01 9	61.19



**Lamella fleece cylinder**  
diameter 100 x 100 mm, bore 19 mm  
For medium satin finish

Grain	Model	Part number	£ List Price excl. VAT
100	medium	6 37 21 008 01 4	41.33



**Lamella fleece cylinder**  
diameter 100 x 100 mm, bore 19 mm  
For fine satin finish

Grain	Model	Part number	£ List Price excl. VAT
180	fine	6 37 21 009 01 8	41.33



**Lamella fleece cylinder**  
diameter 100 x 100 mm, bore 19 mm  
For very fine satin finish

Grain	Model	Part number	£ List Price excl. VAT
280	very fine	6 37 21 010 01 0	41.33



**Felt lamella roller**  
For polishing and pre-polishing stainless steel. Because of the lamella, the felt doesn't "burn" and polishing without streaks is possible. Only use with polishing paste (pre-polishing = pre-polishing paste, high-gloss polishing = colouring paste).

Model	Part number	£ List Price excl. VAT
soft	6 37 21 057 01 0	69.61
medium	6 37 21 058 01 0	69.61



**Sanding fleece**  
with corrugated folds, width approx. 30 mm, bore hole 14 mm, for light finishing work, derusting, polishing, and decorative work

Ø mm	Part number	£ List Price excl. VAT
150	6 37 23 021 01 3	17.33
200	6 37 23 022 01 6	20.51



**Fleece sanding discs**  
Ø 115 mm, with Velcro attachment, for use with support plate  
6 38 06 172 01 0

Model	No. in pack pcs	Part number	£ List Price excl. VAT
course	10	6 37 32 001 01 8	39.28
medium	10	6 37 32 002 01 1	37.33
fine	10	6 37 32 003 01 5	31.98



**Backing pad**  
with Velcro attachment, for working with sanding fleece, M 14

Ø mm	Part number	£ List Price excl. VAT
115	6 38 06 172 01 0	16.02



**Sanding strip roll**  
Bore 19 mm  
100 x 70 mm

Part number	£ List Price excl. VAT
6 38 06 181 01 6	79.44



**Grinding belts**  
600 x 30 mm

Grain	No. in pack pcs	Part number	£ List Price excl. VAT
60	10	6 37 14 044 01 0	24.04
120	10	6 37 14 045 01 4	24.04
240	10	6 37 14 046 01 7	24.04

**Adhesive strip**

For re-fastening grinding belts in closed pipe systems, 50 m

Part number	£ List Price excl. VAT
6 38 09 004 01 9	11.78



**Fleece strips**

With button closure for refastening, ideal for closed pipe systems, 600 x 30 mm

Model	Part number	£ List Price excl. VAT
course	6 37 14 047 01 1	12.85
medium	6 37 14 048 01 9	12.85
fine	6 37 14 049 01 3	12.85



**Polishing rings, Sisal, cloth**

for

- fine finishing/brushing and levelling of non-ferrous metals following preliminary sanding with grain 240-280 using polishing paste "yellow".
- fine finishing/brushing and levelling of iron/steel, and stainless steel following preliminary sanding with grain 280-320 using polishing paste "yellow"
- matt-shining/brushing non-ferrous metals, iron/steel, and stainless steel using polishing paste "yellow".
- Preliminary polishing of iron/steel and stainless steel with preliminary polishing paste "orange" width about 30 mm, 14 mm bore

Ø mm	Part number	£ List Price excl. VAT
150	6 37 23 011 01 4	19.27
200	6 37 23 012 01 7	26.92



**Polishing rings, hard cloth**

Width approx. 15 mm, bore hole 14 mm, for preliminary polishing and polishing of non-ferrous metals, iron/steel, stainless steel with preliminary polishing paste "orange"

Ø mm	Part number	£ List Price excl. VAT
150	6 37 23 013 01 1	11.27
200	6 37 23 015 01 3	13.34



**Polishing rings, soft cloth**

Width approx. 15 mm, bore hole 14 mm, for high-gloss polishing of non-ferrous metals, iron/steel, stainless steel and chrome with final polishing paste "white"

Ø mm	Part number	£ List Price excl. VAT
150	6 37 23 014 01 9	8.80
200	6 37 23 016 01 6	12.82

**Polishing rings, fleece, extra soft**

Width approx. 15 mm, bore hole 14 mm, for final polishing of non-ferrous metals, iron/steel, stainless steel and many plastics with final polishing paste "white"

Ø mm	Part number	£ List Price excl. VAT
150	6 37 23 019 01 2	10.73
200	6 37 23 020 01 4	16.80



**Polishing wheel**

diameter 150 mm, width 60 mm, elastic, bore 14 mm for brush polishing, grain 16 (coarse), soft, "green"

Part number	£ List Price excl. VAT
6 37 13 013 01 8	138.77



**Polishing wheel**  
diameter 150 mm, width 60 mm, elastic, bore 14 mm  
for delicate surfaces, grit 24 (medium), soft, "blue"

Part number	£ List Price excl. VAT
6 37 13 015 01 0	138.77

**Polishing wheel**  
diameter 150 mm, width 60 mm, elastic, bore 14 mm  
for fine polishing, grit 46, soft, "brown"

Part number	£ List Price excl. VAT
6 37 13 016 01 3	138.77



**Flap wheel**  
Width 50 mm, for polishing rust-resistant steel, bore 14 mm

Ø mm	Part number	£ List Price excl. VAT
200	6 37 21 001 00 1	140.18



**Brushing paste**  
yellow, for Sisal/cloth for matt-shining of non-ferrous metals,  
iron/steel, and stainless steel

Part number	£ List Price excl. VAT
6 37 26 027 01 0	8.48



**Preliminary polishing paste**  
orange, for firm cloth, for matt-shining and polishing of  
non-ferrous metals, iron/steel, and stainless steel

Part number	£ List Price excl. VAT
6 37 26 028 01 0	8.48



**Rumbling paste**  
white, for soft cloth, for high-gloss polishing of non-ferrous  
metals, iron/steel, stainless steel, and chrome

Part number	£ List Price excl. VAT
6 37 26 029 01 0	8.48



**Holder**  
for side handle, 360° rotatable

Part number	£ List Price excl. VAT
6 37 33 006 01 0	64.22



**Wheel arbor**  
For satin-finishing tools (cylinders and rollers),  
tool holder Ø 19 mm

Length mm	Part number	£ List Price excl. VAT
50	6 38 03 071 02 0	49.37
100	6 38 03 067 02 8	57.31



**Wheel arbor**  
with clamping flange M 14, for polishing rings,  
clamping range 15-35 mm

Part number	£ List Price excl. VAT
6 38 03 027 03 8	33.01



**Wheel arbor**  
With wheel flange M 14, for lamella sanding discs, buffing  
and polishing discs, holding range 15 – 50 mm, tool mounting  
diameter 14 mm

Part number	£ List Price excl. VAT
6 38 03 066 02 4	36.69



**Safety guard**  
as hand guard

Part number	£ List Price excl. VAT
3 02 29 216 00 5	5.96



**Expansion roller**  
Bore 19 mm  
Ø 100 x 100 mm, for vibration-free, secure holding of  
sanding sleeves

Part number	£ List Price excl. VAT
6 38 06 192 01 0	182.20



**Sanding sleeve**  
For removing small welded seams and very deep scratches and  
mill scale

Grain	No. in pack pcs	Part number	£ List Price excl. VAT
60	5	6 37 14 132 01 0	12.53



**Sanding sleeve**  
For removing deep scratches

Grain	No. in pack pcs	Part number	£ List Price excl. VAT
80	5	6 37 14 133 01 0	12.20



**Sanding sleeve**  
For removing scratches, stage prior to satin-finishing

Grain	No. in pack pcs	Part number	£ List Price excl. VAT
120	5	6 37 14 134 01 0	11.71



**Pyramix sanding sleeve**  
For removing scratches, stage prior to satin-finishing

Grain	No. in pack pcs	Part number	£ List Price excl. VAT
280	5	6 37 14 145 01 0	11.69
400	5	6 37 14 146 01 0	11.69
600	5	6 37 14 147 01 0	11.69
1400	5	6 37 14 148 01 0	11.69





		WPO 14-15 E	WPO 14-15 E marine polishing set	WPO 14-15 E Set	WPO 14-15 E marine polishing set	WPO 14-25 E	WPO 10-25 E	WPO 10-25 E Set
		Extremely powerful angle polisher for vehicle and boat repairs.	Polishing set for boat repairs.	Extremely powerful angle polisher for vehicle and boat repairs.	Polishing set for boat repairs.	Extremely powerful angle polisher for refurbishing paintwork.	Powerful easy-to-use angle polisher for refurbishing paintwork.	
<b>EAN 4014586...</b>		... 862699	... 862712	... 867069	... 872216			
<b>Page</b>		144	144	144	144	144	144	144
<b>Application</b>	Rough sanding	▲	▲▲	▲	▲▲	▲▲		
	Fine sanding	▲	▲▲	▲	▲▲	▲▲		
	Micro-sanding	▲▲	▲▲	▲▲	▲▲	▲▲		
	Dry sanding	▲▲	▲▲	▲▲	▲▲	▲▲		
	polishing	▲▲	▲▲	▲▲	▲▲	▲▲	▲▲	▲▲
<b>Equipment</b>	FEIN high-power motor	●	●	●	●	●	●	●
	Spindle lock	●	●	●	●	●	●	●
	Restart protection	●	●	●	●	●	●	●
	Soft start	●	●	●	●	●	●	●
<b>Technical features</b>	Input	1 200 W	1 200 W	1 200 W	1 200 W	1 200 W	800 W	800 W
	Speed, no load	500 - 1 500 1/min	500 - 1 500 1/min	500 - 1 500 1/min	500 - 1 500 1/min	900 - 2 500 1/min	900 - 2 500 1/min	900 - 2 500 1/min
	Weight according to EPTA	2,50 kg	2,50 kg	2,50 kg	2,50 kg	2,50 kg	2,20 kg	2,20 kg
	Polishing disc Ø	230 mm	230 mm	230 mm	230 mm	230 mm	150 mm	150 mm
	Mounting thread	M 14	M 14	M 14	M 14	M 14	M 14	M 14

▲ suitability    ▲▲ optimal suitability    ● included

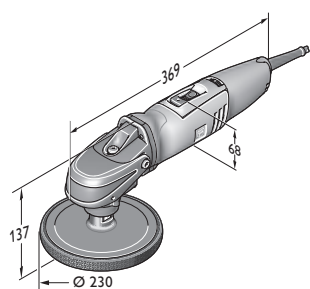

WPO 14-15 E

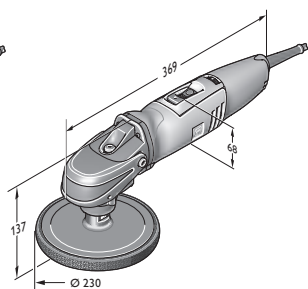

WPO 14-25 E

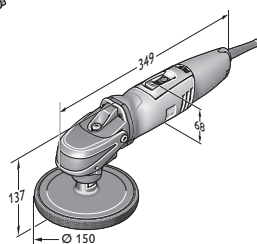

WPO 10-25 E

Surface processing



Type	Part number	EAN	PC	£ List Price excl. VAT
<b>WPO 14-15 E</b>	<b>7 221 48 00 23 0</b>	<b>4014586862699</b>	<b>01</b>	<b>555.00</b>

**Price includes:**  
1 Grip hood, 1 additional handle  
For accessories, see page 145



Type	Part number	EAN	PC	£ List Price excl. VAT
<b>WPO 14-15 E marine polishing set</b>	<b>7 221 48 50 01 0</b>	<b>4014586862712</b>	<b>01</b>	<b>646.00</b>

**Price includes:**  
1 anti-vibration handle, 1 Grip hood, 1 support plate with hook and loop fastening, Ø 170 mm, 1 polishing pad, Ø 195 mm,  
1 lamb's wool, dome shape, Ø 235 mm, 1 Extractor hood, 1 sanding pad Ø 150 mm, 2 sanding fleeces for antifoul, 1 bristle fleece,  
2 of each sanding sheet, Ø 150 mm, perforated, (G 80, 150, 180), 1 plastic carrying case  
For accessories, see page 145



Type	Part number	EAN	PC	£ List Price excl. VAT
<b>WPO 14-15 E Set</b>	<b>7 221 48 51 01 0</b>	<b>4014586867069</b>	<b>01</b>	<b>572.00</b>

**Price includes:**  
1 anti-vibration handle, 1 Grip hood, 1 Support plate with Velcro attachment, Ø 150 mm, 1 Polishing sponge, Ø 150 mm, medium  
For accessories, see page 145



Type	Part number	EAN	PC	£ List Price excl. VAT
<b>WPO 14-15 E marine polishing set</b>	<b>7 221 48 60 00 0</b>	<b>4014586872216</b>	<b>01</b>	<b>525.00</b>

**Price includes:**  
1 anti-vibration handle, 1 Grip hood, 1 support plate with hook and loop fastening, Ø 170 mm, 1 polishing pad, Ø 195 mm,  
1 plastic carrying case  
For accessories, see page 145



Type	Part number	PC	£ List Price excl. VAT
<b>WPO 14-25 E</b>	<b>7 221 49 51</b>	<b>01</b>	<b>572.00</b>

**Price includes:**  
1 anti-vibration handle, 1 Grip hood, 1 Support plate with Velcro attachment, Ø 150 mm, 1 Polishing sponge, Ø 150 mm, medium  
For accessories, see page 145



Type	Part number	PC	£ List Price excl. VAT
<b>WPO 10-25 E</b>	<b>7 221 63 24</b>	<b>01</b>	<b>499.00</b>

**Price includes:**  
1 additional handle, 1 Grip hood  
For accessories, see page 145



Type	Part number	PC	£ List Price excl. VAT
<b>WPO 10-25 E Set</b>	<b>7 221 63 51</b>	<b>01</b>	<b>515.00</b>

**Price includes:**  
1 anti-vibration handle, 1 Grip hood, 1 Support plate with Velcro attachment, Ø 150 mm, 1 Polishing sponge, Ø 150 mm, medium  
For accessories, see page 145

**General accessories**



**Tool case**  
Plastic, inner dimensions: 470 x 275 x 232 mm

Part number	£ List Price excl. VAT
3 39 01 122 01 0	71.38

**Accessories for WPO 10-25 E, WPO 14-15 E, WPO 14-15 XE, WPO 14-25 E**



**Paint refurbishing and finishing set**  
Ideal range of accessories for refurbishing weathered and new paintwork. Also perfectly suited to finishing fresh paintwork (not suitable for matt paintwork). Plastic case contains: 1 FEIN single-stage polish, 1 kg; 1 FEIN top wax paint seal, 1 kg; 1 support plate, 150 mm; 1 lambskin, 150 mm; 2 medium-hard orange polishing sponges, 150 mm; 1 waffle pad; 53 mini sanding discs, grit 2800; 1 manual sanding block; 1 moistening cube; 1 cleaning putty, 200 g; 2 microfibre cloths.

Part number	£ List Price excl. VAT
6 37 23 028 04 0	233.22



**Wax sealing**  
Sprayable lacquer varnish for cleaning and permanently sealing polished surfaces. Removes polishing agent residues from plastic parts.

Contents ml	Part number	£ List Price excl. VAT
500	6 37 26 025 01 0	20.52



**Cleaning putty**  
FEIN cleaning putty gently removes deposits from paintwork and glass such as paint overspray, surface rust, tar, tree gums, insects, environmental deposits and brake dust from rims.

Part number	£ List Price excl. VAT
6 37 33 007 01 0	36.50



**Microfibre cloth**  
Fine weave quality for cleaning polishing residue. Hem-free version means no scratches and no lint

Part number	£ List Price excl. VAT
6 37 33 003 01 0	8.26

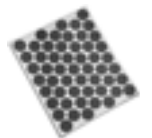

**Sanding disc**  
Micro-fine self-adhesive sandpaper, 2800 grain, for treating lacquer faults such as lacquer inclusions. 1 sheet of 53 sanding discs, Ø 30 mm. Fits on hand sanding block 6 37 33 002 01 0

Part number	£ List Price excl. VAT
6 37 17 221 01 0	10.71



**Humidification sponge**  
Easy-to-use foam cube for hygienic moisturizing the sanding discs.

Part number	£ List Price excl. VAT
6 37 33 001 01 0	3.54



**Sanding block**  
Easy-to-use sanding block for holding self-adhesive sanding discs on both sides.

Part number	£ List Price excl. VAT
6 37 33 002 01 0	13.21



**FEIN single-stage polish**  
Ideal for slightly to severely damaged scratch-resistant paintwork. Excellent shine results in just one step. Silicone-free. Also ideal for gelcoat applications on yachts.

Contents kg	Part number	£ List Price excl. VAT
1	6 37 26 014 01 0	46.94



**Backing pad**  
with Velcro attachment, M 14

Ø mm	Part number	£ List Price excl. VAT
80	6 38 06 179 01 5	23.53
125	6 38 06 169 01 6	14.77
130	6 38 06 178 01 1	32.56
150	6 38 06 170 01 8	17.88



**Backing pad**  
for lamb's fleece with tensioning cord, rubber coated, M 14

Ø mm	Part number	£ List Price excl. VAT
120	6 38 06 012 00 8	17.78



**Polishing sponge**  
For polishing painted surfaces. Various hardness grades: soft for new paintwork, medium for slightly weathered paintwork and applying wax, hard for severely weathered paintwork. Quick hook and loop fastening, height 40 mm.

Ø mm	Model	Part number	£ List Price excl. VAT
100	soft	6 37 23 024 01 8	21.15
100	hard	6 37 23 023 01 0	21.59
125	medium	6 37 23 017 01 0	14.69
150	medium	6 37 23 018 01 8	16.51



**Polishing sponge orange 150 mm**  
Polishing sponge with fine pores, medium hard for new and old lacquers Ø 150 mm

Part number	£ List Price excl. VAT
6 37 23 028 01 0	17.95



**Waffled sponge**  
Extremely fine and soft polishing sponge for removing holograms on dark lacquers. Ø 150 mm

Part number	£ List Price excl. VAT
6 37 23 029 01 0	16.59



**Lambskin**  
with tensioning cord

Ø mm	Part number	£ List Price excl. VAT
120	6 37 23 007 00 2	8.92



**Lambskin**  
with Velcro rapid attachment.

Ø mm	Part number	£ List Price excl. VAT
125	6 37 23 008 00 0	8.61
150	6 37 23 009 00 4	11.06



**FEIN top wax paint seal**  
Long-lasting paint seals thanks to high-quality natural and synthetic waxes. For a sensational shine. Silicone-free.

Contents kg	Part number	£ List Price excl. VAT
1	6 37 26 015 01 0	41.08

### Accessories for WPO 14-15 E



**Backing pad**  
with Velcro attachment, M 14

Ø mm	Part number	£ List Price excl. VAT
170	6 38 06 187 01 0	42.55



**Polishing sponge**  
Ø 195 mm for backing pads with a Ø of 170 mm, 6 38 06 187 01 0, M14 with hook and loop fastening system. Recommended working speed 500-1 000 rpm.

Ø mm	Part number	£ List Price excl. VAT
195	6 37 23 034 01 0	19.92



**Bristle fleece**  
Bristle fleece for cleaning or polishing boat hulls and decks, with a Ø of 195 mm for backing pads with a Ø of 170 mm, 6 38 06 187 01 0, M14 with hook and loop fastening system. For fibreglass anti-slip structures. Recommended working speed: approx. 500 rpm.

Ø mm	Part number	£ List Price excl. VAT
195	6 37 23 033 01 0	31.17



**Lamb's wool, dome shape**  
Diameter approx. 230 mm for backing pads with a Ø of 170 mm, 6 38 06 187 01 0, M 14 with hook and loop fastening system. Recommended working speed 500-1 200 rpm. Quality TOPWOOL, fleece polishing wheel. Lamb's wool/synthetic blend, washable.

Ø mm	Part number	£ List Price excl. VAT
230	6 37 23 035 01 0	26.29



**Sanding pad**  
With hook and loop fastening, Ø 150 mm with M 14 suction hole. Hole circle suitable for FEIN and other sanding materials.

Ø mm	Part number	£ List Price excl. VAT
150	6 38 06 188 01 0	71.00

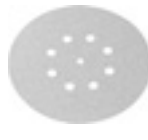

**Sanding sheets**  
perforated, Ø 150 mm, with Velcro rapid attachment  
Application: Metal, car bodies, soldered points, welds, fibreglass. Quality: high-performance emery canvas, fully synthetic-resin bonded, corundum. Features: highly stable, high sanding capacity.

Grain	No. in pack pcs	Part number	£ List Price excl. VAT
60	50	6 37 28 010 01 6	99.15

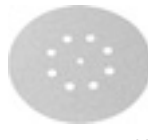

**Sanding sheets**  
perforated, Ø 150 mm, with Velcro rapid attachment  
Application: wood, paint, automotive paints, filler, fibreglass, plastics. Quality: fully synthetic-resin bonded, corundum. Feature: greatly reduces glazing, flexible.

Grain	No. in pack pcs	Part number	£ List Price excl. VAT
80	50	6 37 28 074 01 4	49.87
120	50	6 37 28 084 01 3	42.91
150	50	6 37 28 012 01 8	42.91
180	50	6 37 28 013 01 2	42.91
240	50	6 37 28 015 01 4	42.91
320	50	6 37 28 017 01 1	42.91



**Sanding fleece for antifouling**  
Sanding fleece for light sanding and sanding down of coats of antifouling product. Produces a stunning sanding pattern without choking the sanding fleece. Very long service life.

Ø mm	No. in pack pcs	Part number	£ List Price excl. VAT
150	5	6 37 32 004 01 0	22.76



**Protection suction hood**

Part number	£ List Price excl. VAT
3 18 10 264 01 0	21.39



**Connecting piece**  
Universal device to connect power tools and accessories with dust extraction to vacuum cleaner. Flexible rubber sleeve, length 70 mm, inner diameter 31.5 mm.

Part number	£ List Price excl. VAT
3 13 22 771 00 9	5.59

### Accessories for WPO 10-25 E, WPO 14-15 E



**Tool case**  
Plastic, inner dimensions: 470 x 275 x 116 mm

Part number	£ List Price excl. VAT
3 39 01 118 01 0	46.09

### Accessories for WPO 14-15 E, WPO 14-25 E



**Nylon barrel brush**  
Ø 125 mm, grain 46, M 14, for brushing after removal by caustics, cleaning roof beams, restoration of antique furniture, roughing paint for new coats, deburring, and light derusting of metal parts

Part number	£ List Price excl. VAT
6 37 22 048 01 4	42.66



### Accessories for WPO 14-15 E, WPO 14-15 XE



**Backing pad**  
with Velcro attachment, M 14

Ø mm	Part number	£ List Price excl. VAT
200	6 38 06 171 01 7	28.21



**Backing pad**  
for lamb's fleece with tensioning cord, rubber coated, M 14

Ø mm	Part number	£ List Price excl. VAT
170	6 38 06 030 00 4	25.08



**Polishing sponge**  
For polishing painted surfaces. Various hardness grades: soft for new paintwork, medium for slightly weathered paintwork and applying wax, hard for severely weathered paintwork. Quick hook and loop fastening, height 40 mm.

Ø mm	Model	Part number	£ List Price excl. VAT
160	soft	6 37 23 026 01 5	26.93
160	hard	6 37 23 025 01 2	26.93



**Lambskin**  
with tensioning cord

Ø mm	Part number	£ List Price excl. VAT
170	6 37 23 003 00 3	16.64



**Lambskin**  
with Velcro rapid attachment.

Ø mm	Part number	£ List Price excl. VAT
200	6 37 23 010 00 6	18.54



## Over 50 years of experience: oscillating power tools from FEIN.

Backed by the unique experience acquired over more than 50 years of oscillation technology, FEIN offers three systems FEIN MULTIMASTER, FEIN SUPERCUT CONSTRUCTION and FEIN SUPERCUT AUTOMOTIVE - which make up an unbeatably versatile and powerful range of oscillating power tools. Each system is synonymous with professional application solutions and unrivalled load handling with a solution for every requirement. The FEIN SUPERCUT is the specialist for interior work with wood, repairing/replacing windows, tile restoration/bathroom renovation, heating/sanitary installation, grout renewal, marine applications and vehicle

glazing. As a universal system, the FEIN MULTIMASTER is the right choice for everyone who strives for a versatile, professional tool. A wide range of accessories opens up a multitude of possible applications.



---

**FEIN MULTIMASTER / MULTITALENT** **Page 150**

The universal system for interior work and renovation.

**STARLOCK PLUS**



---

**FEIN SUPERCUT CONSTRUCTION** **Page 154**

The most powerful system for interior work and renovation.

**STARLOCK MAX**



---

**FEIN SUPERCUT CONSTRUCTION** **Page 170**

The most powerful system for interior work and renovation.



---

**FEIN SUPERCUT AUTOMOTIVE** **Page 176**

The most powerful system for vehicle repairs.



	FEIN cordless MULTIMASTER AFMM 18 QSL	FEIN cordless MULTIMASTER AFMM 18 QSL Select	FEIN cordless MULTITALENT AFMT 12 QSL QuickStart	FEIN cordless MULTITALENT AFMT 12 SL Start	FEIN cordless MULTITALENT AFMT 12 QSL Select	
	The high-performance, battery-powered universal system for interior work and renovation with QuickIN and accessories for a wide range of applications.	Select version - the smart choice if you already have FEIN battery and charging technology.	The battery-powered, universal system for interior work and renovation with QuickIN and the basic accessories needed for sanding and sawing.	The battery-powered, universal system for interior work and renovation and the basic accessories needed for sanding and sawing.	Select version - the smart choice if you already have FEIN battery and charging technology.	
<b>EAN 4014586...</b>	... 884097	... 885704	... 884172	... 884257	... 885711	
<b>Page</b>	152	152	152	152	152	
<b>Technical features</b>	Input					
	Battery voltage	18 V	18 V	12 V	12 V	12 V
	Battery capacity	2,5 Ah		2,5 Ah	2,5 Ah	
	Battery compatibility	Li-ion/ HighPower Li-ion	Li-ion/ HighPower Li-ion	Li-ion	Li-ion	Li-ion
	Battery interface	18 V	18 V	18 V	18 V	18 V
	Oscillations	11 000 - 18 500 1/min	11 000 - 18 500 1/min	11 000 - 18 000 1/min	11 000 - 18 000 1/min	11 000 - 18 000 1/min
	Sanding pad width	80 mm	80 mm	80 mm	80 mm	80 mm
	Tool Holder	StarlockPlus	StarlockPlus	StarlockPlus	StarlockPlus	StarlockPlus
	Tool change	QuickIN	QuickIN	QuickIN	Manual with screw, hexagon socket	QuickIN
	Amplitude	2 x 1,7°	2 x 1,7°	2 x 1,6°	2 x 1,6°	2 x 1,6°
	Weight according to EPTA					
	Weight with battery	1,80 kg		1,50 kg	1,40 kg	
	Weight without storage battery		1,30 kg			1,10 kg
Mechanical interface	●	●				

● included

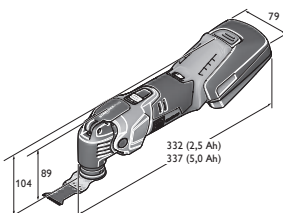

AFMM 18 QSL

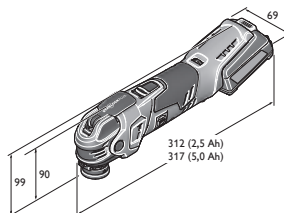

AFMT 12 QSL

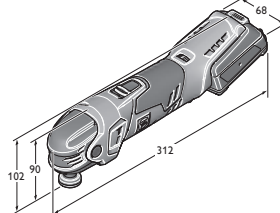

AFMT 12 SL

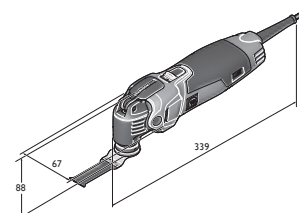

FMM 350 QSL





	<b>FEIN MULTIMASTER FMM 350 QSL Top</b>	<b>FEIN MULTIMASTER FMM 350 QSL QuickStart</b>	<b>FEIN MULTIMASTER FMM 350 QSL Marine</b>	<b>FEIN MULTITALENT FMT 250 QSL QuickStart</b>	<b>FEIN MULTITALENT FMT 250 SL Start</b>
	The powerful and universal system for interior work and renovation with the most extensive accessories for a fantastic range of applications.	The powerful and universal system for interior work and renovation with accessories for a wide range of applications.	The powerful and universal system with extensive accessories for interior, maintenance and repair work on yachts.	The universal system for interior work and renovation with QuickIN and the basic accessories needed for sanding and sawing.	The universal system for interior work and renovation with the basic accessories needed for sanding and sawing.
	152	153	153	153	153
	350 W	350 W	350 W	250 W	250 W
	10 000 - 19 500 1/min	10 000 - 19 500 1/min	10 000 - 19 500 1/min	11 000 - 20 000 1/min	11 000 - 20 000 1/min
	80 mm	80 mm	80 mm	80 mm	80 mm
	StarlockPlus	StarlockPlus	StarlockPlus	StarlockPlus	StarlockPlus
	QuickIN	QuickIN	QuickIN	QuickIN	Manual with screw, hexagon socket
	2 x 1,7°	2 x 1,7°	2 x 1,7°	2 x 1,6°	2 x 1,6°
	1,40 kg	1,40 kg	1,40 kg	1,40 kg	1,30 kg
	•	•	•		

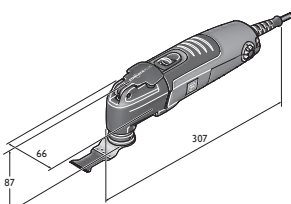

FMT 250 QSL  
FMT 250 SL



Type	Part number	EAN	PC	£ List Price excl. VAT
<b>FEIN cordless MULTIMASTER AFMM 18 QSL</b>	<b>7 129 22 61 24 0</b>	<b>4014586884097</b>	<b>03</b>	<b>408.00</b>

**Price includes:**

1 sanding pad, Sanding sheets, 3 each of grit 60, 80, 120, 180, 1 fixed scraper, 1 HSS segment saw blade, 1 E-CUT long-life saw blade (65 mm), 1 Universal E-CUT saw blade (44 mm), 1 rapid charger ALG 50, 2 Li-ion batteries (2,5 Ah), 1 plastic carrying case

For accessories, see page 158

**FEIN SELECT<sup>+</sup>**



Type	Part number	EAN	PC	£ List Price excl. VAT
<b>FEIN cordless MULTIMASTER AFMM 18 QSL Select</b>	<b>7 129 22 62 00 0</b>	<b>4014586885704</b>	<b>03</b>	<b>211.00</b>

**Price includes:**

1 plastic carrying case

For accessories, see page 158



Type	Part number	EAN	PC	£ List Price excl. VAT
<b>FEIN cordless MULTITALENT AFMT 12 QSL QuickStart</b>	<b>7 129 25 61 24 0</b>	<b>4014586884172</b>	<b>03</b>	<b>287.00</b>

**Price includes:**

1 sanding pad, Sanding sheets, 3 each of grit 80, 120, 180, 1 Universal E-CUT saw blade (29 mm), 1 rapid charger ALG 50, 2 Li-ion batteries (2,5 Ah), 1 plastic carrying case

For accessories, see page 158



Type	Part number	EAN	PC	£ List Price excl. VAT
<b>FEIN cordless MULTITALENT AFMT 12 SL Start</b>	<b>7 129 26 61 24 0</b>	<b>4014586884257</b>	<b>03</b>	<b>264.00</b>

**Price includes:**

1 sanding pad, Sanding sheets, 3 each of grit 80, 120, 180, 1 Universal E-CUT saw blade (29 mm), 1 rapid charger ALG 50, 2 Li-ion batteries (2,5 Ah), 1 plastic carrying case

For accessories, see page 158

**FEIN SELECT<sup>+</sup>**



Type	Part number	EAN	PC	£ List Price excl. VAT
<b>FEIN cordless MULTITALENT AFMT 12 QSL Select</b>	<b>7 129 25 62 00 0</b>	<b>4014586885711</b>	<b>03</b>	<b>178.00</b>

**Price includes:**

1 plastic carrying case

For accessories, see page 158



Type	Part number	PC	£ List Price excl. VAT
<b>FEIN MULTIMASTER FMM 350 QSL Top</b>	<b>7 229 52 61</b>	<b>03</b>	<b>351.00</b>

**Price includes:**

1 sanding pad, Sanding sheets, 3 each of grit 60, 80, 120, 180, 1 Sanding plate with holes, Perforated sanding sheets, 3 each of grit 60, 80, 120, 180, 1 backing pad Ø 115 mm, perforated, Perforated sanding sheets, 2 each of grit 60, 80, 180, 1 dust extraction device, 1 fixed scraper, 1 E-CUT long-life saw blade (35 mm), 1 Universal E-CUT saw blade (44 mm), 1 E-CUT long-life saw blade (65 mm), 1 HSS segment saw blade, 1 carbide segment saw blade, 1 carbide rasp (triangular), perforated, 1 plastic carrying case

For accessories, see page 158



Type	Part number	PC	£ List Price excl. VAT
<b>FEIN MULTIMASTER FMM 350 QSL QuickStart</b>	<b>7 229 52 62</b>	<b>03</b>	<b>293.00</b>

**Price includes:**

1 sanding pad, Sanding sheets, 3 each of grit 60, 80, 120, 180, 1 fixed scraper, 1 Universal E-CUT saw blade (44 mm), 1 E-CUT long-life saw blade (65 mm), 1 HSS segment saw blade, 1 plastic carrying case

For accessories, see page 158



Type	Part number	PC	£ List Price excl. VAT
<b>FEIN MULTIMASTER FMM 350 QSL Marine</b>	<b>7 229 52 66</b>	<b>03</b>	<b>385.00</b>

**Price includes:**

1 sanding pad, Perforated sanding sheets, 3 each of grit 60, 80, 120, 180, 1 Sanding plate with holes, Sanding sheets, 3 each of grit 60, 80, 120, 180, 1 backing pad Ø 115 mm, perforated, Perforated sanding sheets, 2 each of grit 60, 80, 180, 1 fixed scraper, 2 felt polishing pads, triangular, 2 felt polishing pads 115 mm in diameter, 1 dust extraction device, 1 carbide segment saw blade, 1 carbide file, 1 E-CUT long-life saw blade (10 mm), 1 of each deck cutter blade (4+5 mm), 1 Universal E-CUT saw blade (44 mm), 1 E-CUT long-life saw blade (35 mm), 1 HSS saw blade (diameter 85 mm), 1 plastic carrying case

For accessories, see page 158



Type	Part number	PC	£ List Price excl. VAT
<b>FEIN MULTITALENT FMT 250 QSL QuickStart</b>	<b>7 229 53 61</b>	<b>03</b>	<b>238.00</b>

**Price includes:**

1 sanding pad, Sanding sheets, 3 each of grit 80, 120, 180, 1 Universal E-CUT saw blade (44 mm), 1 plastic carrying case

For accessories, see page 158



Type	Part number	PC	£ List Price excl. VAT
<b>FEIN MULTITALENT FMT 250 SL Start</b>	<b>7 229 54 61</b>	<b>03</b>	<b>180.00</b>

**Price includes:**

1 sanding pad, Sanding sheets, 3 each of grit 80, 120, 180, 1 Universal E-CUT saw blade (44 mm), 1 plastic carrying case

For accessories, see page 158



	FEIN cordless SUPERCUT AFSC 18 QSL	FEIN cordless SUPERCUT AFSC 18 QCSL	FEIN cordless SUPERCUT AFSC 18 QSL Select	FEIN cordless SUPERCUT AFSC 18 QSL for interior work with wood	FEIN cordless SUPERCUT AFSC 18 QSL for repairing/replacing windows	FEIN cordless SUPERCUT AFSC 18 QSL for tile restoration/ bathroom renovation
	The most powerful cordless oscillator with rapid clamping system for interior work and renovation.			The most powerful system for interior work and renovation with special accessories for fast and precise sawing work when fitting wood.	The most powerful system for interior work and renovation with special accessories for dismantling old windows and replacing putty-mounted insulating glass.	The most powerful system for interior work and renovation with special accessories for perfect removal of tiles and joints in bathroom renovation.
<b>EAN 4014586...</b>	... 884332	... 884370	... 884295	... 884400	... 884424	... 884431
<b>Page</b>	156	156	156	156	156	156
<b>Technical features</b>	Input					
	Output					
	Battery voltage	18 V	18 V	18 V	18 V	18 V
	Battery capacity	5 Ah	2,5 Ah		5 Ah	5 Ah
	Battery compatibility	Li-ion/ HighPower Li-ion	Li-ion/ HighPower Li-ion	Li-ion/ HighPower Li-ion	Li-ion/ HighPower Li-ion	Li-ion/ HighPower Li-ion
	Battery interface	MultiVolt	MultiVolt	MultiVolt	MultiVolt	MultiVolt
	Oscillations	10 000 - 19 500 1/min	10 000 - 19 500 1/min	10 000 - 19 500 1/min	10 000 - 19 500 1/min	10 000 - 19 500 1/min
	Tool Holder	StarlockMax	StarlockMax	StarlockMax	StarlockMax	StarlockMax
	Tool change	QuickIN	QuickIN	QuickIN	QuickIN	QuickIN
	Cable with plug					
	Weight according to EPTA					
	Weight with battery	1,80 kg	1,60 kg		1,80 kg	1,80 kg
Weight without storage battery	1,10 kg	1,10 kg	1,10 kg		1,10 kg	
Mechanical interface	●	●	●	●	●	

- included

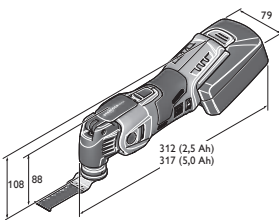

AFSC 18 QSL

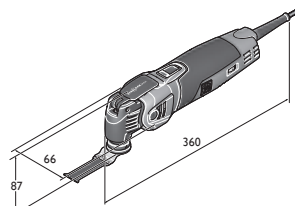

FSC 500 QSL



	<b>FEIN cordless SUPER-CUT AFSC 18 QSL for heating/sanitary installation</b>	<b>FEIN SUPER-CUT FSC 500 QSL</b>	<b>FEIN SUPER-CUT FSC 500 QSL for interior work with wood</b>	<b>FEIN SUPER-CUT FSC 500 QSL for tile restoration/ bathroom renovation</b>	<b>FEIN SUPER-CUT FSC 500 QSL for heating/sanitary installation</b>	<b>FEIN SUPER-CUT FSC 500 QSL Composite</b>
	The most powerful system for interior work and renovation with special accessories for the key applications in sanitary repairs.	The powerful oscillator with quick clamping system for interior fitting and renovation.	The most powerful system for interior work and renovation with special accessories for fast and precise sawing work when fitting wood.	The most powerful system for interior work and renovation with special accessories for perfect removal of tiles and joints in bathroom renovation.	The most powerful system for interior work and renovation with special accessories for the key applications in sanitary repairs.	The most powerful system for interior work and renovation, for all key applications in the machining of CFRP and GRP parts.
	... 884448				... 885407	... 885414
	156	157	157	157	157	157
		450 W	450 W	450 W	450 W	450 W
		250 W	250 W	250 W	250 W	250 W
	18 V					
	5 Ah					
	Li-ion/ HighPower Li-ion					
	MultiVolt					
	10 000 - 19 500 1/min	10 000 - 19 500 1/min	10 000 - 19 500 1/min	10 000 - 19 500 1/min	10 000 - 19 500 1/min	10 000 - 19 500 1/min
	StarlockMax	StarlockMax	StarlockMax	StarlockMax	StarlockMax	StarlockMax
	QuickIN	QuickIN	QuickIN	QuickIN	QuickIN	QuickIN
		5 m	5 m	5 m	5 m	5 m
		1,60 kg	1,60 kg	1,60 kg	1,60 kg	1,60 kg
	1,80 kg					
	1,10 kg					
	•	•	•	•	•	



Type	Part number	EAN	PC	£ List Price excl. VAT
<b>FEIN cordless SUPERCUT AFSC 18 QSL</b>	<b>7 129 27 61 24 0</b>	<b>4014586884332</b>	<b>03</b>	<b>560.00</b>

**Price includes:**  
2 battery packs (Li-ion), 1 battery charger, 1 plastic carrying case  
For accessories, see page 158



Type	Part number	EAN	PC	£ List Price excl. VAT
<b>FEIN cordless SUPERCUT AFSC 18 QCSL</b>	<b>7 129 27 62 24 0</b>	<b>4014586884370</b>	<b>03</b>	<b>509.00</b>

**Price includes:**  
1 battery charger, 2 battery packs (Li-ion), 1 plastic carrying case  
For accessories, see page 158

**FEIN SELECT<sup>+</sup>**



Type	Part number	EAN	PC	£ List Price excl. VAT
<b>FEIN cordless SUPERCUT AFSC 18 QSL Select</b>	<b>7 129 27 60 00 0</b>	<b>4014586884295</b>	<b>03</b>	<b>292.00</b>

**Price includes:**  
1 plastic carrying case  
Tool must only be operated with new 2.5 A h (9 26 04 171 02 0) or 5 Ah (9 26 04 173 02 0) storage batteries  
For accessories, see page 158



Type	Part number	EAN	PC	£ List Price excl. VAT
<b>FEIN cordless SUPERCUT AFSC 18 QSL for interior work with wood</b>	<b>7 129 27 64 24 0</b>	<b>4014586884400</b>	<b>03</b>	<b>726.00</b>

**Price includes:**  
1 HSS saw blade wood Ø 100 mm, 1 depth stop, 2 E-Cut precision BIM saw blades (form 205, 208), 5 E-Cut long-life saw blades (form 183, 160, 161, 201, 203), 2 E-Cut universal saw blades (form 151, 152), 1 sanding pad, 5 Sanding sheets each grit size (K 80, 120, 180), 2 battery packs (Li-ion), 1 battery charger, 1 plastic carrying case  
For accessories, see page 158



Type	Part number	EAN	PC	£ List Price excl. VAT
<b>FEIN cordless SUPERCUT AFSC 18 QSL for repairing/replacing windows</b>	<b>7 129 27 66 00 0</b>	<b>4014586884424</b>	<b>03</b>	<b>726.00</b>

**Price includes:**  
1 HSS saw blade wood Ø 100 mm, 1 HSS saw blade for metal (diameter 100 mm), 1 E-Cut long-life saw blade (form 203), 1 E-Cut universal saw blade (form 152), 1 Cutter blade, mushroom shaped, 1 segment saw blade (form 244), 1 depth stop, 1 sanding pad, 5 Sanding sheets each grit size (K 80, 120, 180), 2 battery packs (Li-ion), 1 battery charger, 1 plastic carrying case  
For accessories, see page 158



Type	Part number	EAN	PC	£ List Price excl. VAT
<b>FEIN cordless SUPERCUT AFSC 18 QSL for tile restoration/bathroom renovation</b>	<b>7 129 27 67 00 0</b>	<b>4014586884431</b>	<b>03</b>	<b>726.00</b>

**Price includes:**  
1 segment blade, diamond-coated (form 243), 1 carbide saw blade, diameter 105 mm (form 214), 2 E-Cut universal saw blades (form 151, 152), 1 Cutter blade, mushroom shaped, 1 Stopper knife, 2 Rasps, carbide-coated, triangular, perforated for dust extractor, 2 battery packs (Li-ion), 1 battery charger, 1 plastic carrying case  
For accessories, see page 158



Type	Part number	EAN	PC	£ List Price excl. VAT
<b>FEIN cordless SUPERCUT AFSC 18 QSL for heating/sanitary installation</b>	<b>7 129 27 68 00 0</b>	<b>4014586884448</b>	<b>03</b>	<b>726.00</b>

**Price includes:**  
1 segment blade, diamond-coated (form 243), 1 of each cutting tool (12, 13 and 22 mm), 1 cutter blade, straight, long (form 239), 2 E-Cut universal saw blades (form 151, 152), 1 Stopper knife, 1 carbide-coated rasp, triangular, perforated for dust extraction, 2 battery packs (Li-ion), 1 battery charger, 1 plastic carrying case  
For accessories, see page 158



Type	Part number	PC	£ List Price excl. VAT
<b>FEIN SUPERCUT FSC 500 QSL</b>	<b>7 229 46 61</b>	<b>03</b>	<b>502.00</b>

**Price includes:**  
1 Systainer Sys 1  
For accessories, see page 158



Type	Part number	PC	£ List Price excl. VAT
<b>FEIN SUPERCUT FSC 500 QSL for interior work with wood</b>	<b>7 229 46 62</b>	<b>03</b>	<b>625.00</b>

**Price includes:**  
1 HSS saw blade wood Ø 100 mm, 1 depth stop, 2 E-Cut precision BIM saw blades (form 205, 208), 5 E-Cut long-life saw blades (form 183, 160, 161, 201, 203), 2 E-Cut universal saw blades (form 151, 152), 1 sanding pad, 5 Sanding sheets each grit size (K 80, 120, 180), 1 Systainer Sys 1  
For accessories, see page 158



Type	Part number	PC	£ List Price excl. VAT
<b>FEIN SUPERCUT FSC 500 QSL for tile restoration/bathroom renovation</b>	<b>7 229 46 64</b>	<b>03</b>	<b>625.00</b>

**Price includes:**  
1 segment blade, diamond-coated (form 243), 1 carbide saw blade, diameter 105 mm (form 214), 2 E-Cut universal saw blades (form 151, 152), 1 Cutter blade, mushroom shaped, 1 Stopper knife, 2 Rasps, carbide-coated, triangular, perforated for dust extractor, 1 Systainer Sys 1  
For accessories, see page 158



Type	Part number	EAN	PC	£ List Price excl. VAT
<b>FEIN SUPERCUT FSC 500 QSL for heating/sanitary installation</b>	<b>7 229 46 65 00 0</b>	<b>4014586885407</b>	<b>03</b>	<b>625.00</b>

**Price includes:**  
1 segment blade, diamond-coated (form 243), 1 of each cutting tool (12, 13 and 22 mm), 1 cutter blade, straight, long (form 239), 2 E-Cut universal saw blades (form 151, 152), 1 Stopper knife, 1 carbide-coated rasp, triangular, perforated for dust extraction, 1 Systainer Sys 1  
For accessories, see page 158



Type	Part number	EAN	PC	£ List Price excl. VAT
<b>FEIN SUPERCUT FSC 500 QSL Composite</b>	<b>7 229 46 67 00 0</b>	<b>4014586885414</b>	<b>03</b>	<b>663.00</b>

**Price includes:**  
1 E-Cut universal saw blade (form 152), 1 diamond saw blade, diameter 105 mm, 1 E-Cut carbide saw blade (form 191), 1 carbide file, 1 sanding pad, 5 Sanding sheets each grit size (K 80, 120, 180), 1 carbide-coated rasp, triangular, perforated for dust extraction, 1 dust extraction device, 1 plastic carrying case  
For accessories, see page 158





Oscillating  
multi-tool

# Starlock: The new system standard for oscillating power tools.

Combined with the new FEIN tools, Starlock enables extremely reliable and fast accessory changes in a record time of less than 3 seconds. It also guarantees a secure fit and therefore optimum power transfer. The result: up to around 35% faster work progress depending on the accessory, noticeably improved precision and reduced noise. The new accessories are of course 100% compatible with all older FEIN oscillators on the market. To protect the individual tools from overload and damage, the system is divided into 3 performance classes: Starlock, StarlockPlus and StarlockMax. What has not changed: New products are continually being added to the range of FEIN genuine accessories, which is the largest

accessory range on the market. The performance potential of an oscillating tool can only be fully exploited with the right accessories. The exceptional quality and service life of FEIN genuine accessories combined with the perfect results delivers excellent value for money. FEIN genuine accessories are always the best choice.

The following table shows at a glance which accessory suits which product:

	<b>STARLOCK</b> 	<b>STARLOCK PLUS</b> 	<b>STARLOCK MAX</b> 	
	Universal Starlock fitting, suitable for all popular multi-function tools.	or all popular multi-function tools with StarlockPlus and StarlockMax fitting and for all FEIN MULTITALENT and MULTIMASTER tools up until 04/16.	StarlockMax fitting, can be used on all multi-function tools with suitable fitting. With adapter, suitable for all FEIN SUPERCUT before 04/16 too.	FEIN SUPERCUT 12-sided fitting, suitable for all FEIN SUPERCUT FSC 2.0 (Q), FSC 1.6 (Q), (A)FSC 1.7 (Q), AFSC 18.
Starlock (SL)	SL	SLP	SLM	
BOSCH GOP 12 V-28 PMF 220 CE, PMF 250 CES	✓	✗	✗	✗
StarlockPlus (SLP)				
FEIN MULTITALENT: AFMT 12 SL, AFMT 12 QSL FMT 250 SL, FMT 250 QSL				
FEIN MULTIMASTER: AFMM 18 QSL FMM 350 QSL	✓	✓	✗	✗
BOSCH: GOP 30-28, GOP 40-30, GOP 18 V-28 PMF 350 CES				
StarlockMax (SLM)				
FEIN SUPERCUT: AFSC 18 QSL, AFSC 18 QCSL FSC 500 QSL	✓	✓	✓	✗
BOSCH GOP 55-36				
Compatibility with FEIN tools without Starlock mounting				
FEIN MULTITALENT/ MULTIMASTER (- 03/2016)	✓	✓	✗	✗
FEIN SUPERCUT CONSTRUCTION (- 03/2016) FSC 2.0 Q, AFSC 18		✓		
FEIN SUPERCUT AUTOMOTIVE FSC 1.6 Q, FSC 1.7 Q, AFSC 1.7 Q, AFSC 1.7 QC		+ adapter 3 52 22 952 05 0		✓
FEIN SUPERCUT AUTOMOTIVE FSC 1.6, FSC 1.7		✓ + adapter 3 52 22 952 04 0		
Miscellaneous multi-tools				
Makita, Hitachi, Metabo, Milwaukee, AEG, Einhell, Ryobi, Skil, etc.	✓	✗	✗	✗

Starlock, the new standard tool mounting for multi-tools with patent pending, was jointly developed by FEIN and Bosch. Starlock, StarlockPlus and StarlockMax are registered trademarks of C. & E. Fein GmbH and Robert Bosch GmbH.





**Sawing**



**Saw blade**

For all soft materials. Segmented, ideal for working in corners and on edges without overcutting.

Ø mm	Mount	Part number	£ List Price excl. VAT
85	SL	6 35 02 113 21 0	19.26



**HSS saw blade**

Solid HSS saw blade with metal teeth for sheet metal up to approx. 1 mm. Also for plastics, fibreglass-reinforced plastic, wood, putty and copper/copper alloys. Outstanding cutting speed. Clean, thin cutting line. Circular shape delivers good cost-effectiveness.

Ø mm	Mount	No. in pack pcs	Part number	£ List Price excl. VAT
85	SL	1	6 35 02 097 21 0	19.71
85	SL	2	6 35 02 097 22 0	39.53
85	SL	5	6 35 02 097 23 0	88.74



**HSS saw blade**

Solid HSS saw blade with metal teeth for sheet metal up to approx. 1 mm. Also for plastics, fibreglass-reinforced plastic, wood, putty and copper/copper alloys. Outstanding cutting speed. Clean, thin cutting line. Segmented, ideal for working in corners and on edges without overcutting.

Ø mm	Mount	No. in pack pcs	Part number	£ List Price excl. VAT
85	SL	1	6 35 02 106 21 0	22.62
85	SL	2	6 35 02 106 22 0	42.98
85	SL	5	6 35 02 106 23 0	101.78



**HSS saw blade**

Bimetal for long tool life. Metal teeth for sheet metal up to approx. 1 mm. Also for plastics, fibreglass-reinforced plastic, wood, putty and copper/copper alloys. Work flush with the surface. Circular shape delivers good cost-effectiveness.

Ø mm	Mount	No. in pack pcs	Part number	£ List Price excl. VAT
85	SL	1	6 35 02 174 21 0	40.30
85	SL	5	6 35 02 174 23 0	181.35



**HSS saw blade**

Bimetal for long tool life. Metal teeth for sheet metal up to approx. 1 mm. Also for plastics, fibreglass-reinforced plastic, wood, putty and copper/copper alloys. Work flush with the surface. Circular shape and extra large diameter deliver optimum cost-effectiveness.

Ø mm	Mount	No. in pack pcs	Part number	£ List Price excl. VAT
100	SLP	1	6 35 02 175 21 0	41.96
100	SLP	5	6 35 02 175 23 0	188.81



**HSS saw blade**

Bimetal for long tool life. Metal teeth for sheet metal up to approx. 1 mm. Also for plastics, fibreglass-reinforced plastic, wood, putty and copper/copper alloys. Work flush with the surface. Segmented, ideal for working in corners and on edges without overcutting.

Ø mm	Mount	No. in pack pcs	Part number	£ List Price excl. VAT
100	SLP	1	6 35 02 196 21 0	41.96
100	SLP	5	6 35 02 196 23 0	188.81



**HSS saw blade**

Bimetal for long tool life. Set wood teeth. Outstanding tool life, high cutting quality and speed. As "mini circular saw", ideal for long, straight cuts and for making cut-outs in laid parquet, laminate and wall panelling.

Ø mm	Mount	No. in pack pcs	Part number	£ List Price excl. VAT
100	SLP	1	6 35 02 176 21 0	49.98



**HSS saw blade set**

Bimetal for long tool life. Set wood teeth. Outstanding tool life, high cutting quality and speed. As "mini circular saw", ideal for long, straight cuts and for making cut-outs in laid parquet, laminate and wall panelling. The depth stop can also be used with many other FEIN accessories. For accurate working at depth. StarlockPlus fitting, suitable for all popular multi-function tools with StarlockPlus and StarlockMax fitting and for all FEIN MULTITALENT and MULTIMASTER tools up until 04/16. Scope of supply: 1 HSS saw blade, 1 depth stop (suitable for FMM 350 QSL, AFMM 18 QSL, AFSC 18 QSL, FSC 500 QSL)

Ø mm	Mount	Part number	£ List Price excl. VAT
100	SLP	3 52 22 952 01 0	63.74



**Contact guard**

Spare contact guard for HSS saw blade 6 35 02 176 21 0.

Part number	£ List Price excl. VAT
3 43 00 000 00 1	4.58



**Depth stop**

Depth stop for all saw blades. For accurate working at depth. Effective protection for blade and workpiece. Contents: 1 adapter for attachment to the machine, rotates freely through 360°. 1 depth stop, 1 depth-adjustable guide block. Can only be used with (A)FMM or (A)FSC.

Part number	£ List Price excl. VAT
3 21 27 069 01 0	20.15



**Best of E-Cut accessory set**

Includes 6 different E-CUT saw blades with bimetallic teeth at a special price in a practical plastic storage box. Contents: E-CUT universal saw blades (1 x 28 mm and 1 x 44 mm wide) and E-CUT long-life saw blades (2 x 35 mm and 2 x 65 mm wide).

Mount	Part number	£ List Price excl. VAT
SLP	3 52 22 942 05 0	62.15



**Best of E-Cut accessory set**

Comprising 6 different E-CUT saw blades with bimetallic teeth at a special price. With Starlock mounting, suitable for all popular oscillating multi-tools on the market. Also compatible with Bosch, Makita, Metabo, Ridgid, Skil and many more. Content: 2 each of E-CUT long-life saw blades with widths of 35 mm and 50 mm and 2 x E-CUT universal saw blades, 28 mm wide.

Mount	Part number	£ List Price excl. VAT
SL	3 52 22 952 30 0	39.90



**E-Cut-Combo**

Collection of the 3 most popular FEIN E-CUT saw blades for universal use. Better value than buying items separately. Perfectly equipped for all sawing applications. Supplied: 1 E-CUT long-life saw blade 35 mm wide, 1 E-CUT long-life saw blade 65 mm wide and 1 E-CUT universal saw blade 44 mm wide.

Mount	Part number	£ List Price excl. VAT
SLP	3 52 22 952 03 0	42.03



**E-Cut long-life saw blade**

Bimetal with set wood teeth for all wood, plasterboard and plastic materials. Outstanding tool life, high cutting quality and speed. Extremely robust, not affected by nails (up to diameter of approx. 4 mm) in wood, masonry etc. Short, very narrow shape for the smallest of recesses.

Width mm	Length mm	Mount	No. in pack pcs	Part number	£ List Price excl. VAT
10	30	SL	1	6 35 02 184 21 0	7.46
10	30	SL	3	6 35 02 184 22 0	21.30
10	30	SL	5	6 35 02 184 23 0	33.60
10	30	SL	10	6 35 02 184 24 0	63.45
10	30	SL	50	6 35 02 184 25 0	302.61
20	34	SL	1	6 35 02 183 21 0	9.76
20	34	SL	3	6 35 02 183 22 0	27.79
20	34	SL	5	6 35 02 183 23 0	43.89
20	34	SL	10	6 35 02 183 24 0	82.84
20	34	SL	50	6 35 02 183 25 0	395.03

Oscillating multi-tool



**E-Cut long-life saw blade**

Bimetal with set wood teeth for all wood, plasterboard and plastic materials. Outstanding tool life, high cutting quality and speed. Extremely robust, not affected by nails (up to diameter of approx. 4 mm) in wood, masonry etc. Medium width, with waist for optimum cutting speed and good swarf removal.

Width mm	Length mm	Mount	No. in pack pcs	Part number	£ List Price excl. VAT
35	50	SL	1	6 35 02 160 21 0	12.85
35	50	SL	3	6 35 02 160 22 0	36.63
35	50	SL	5	6 35 02 160 23 0	57.85
35	50	SL	10	6 35 02 160 24 0	109.30
35	50	SL	50	6 35 02 160 25 0	520.62



**E-Cut long-life saw blade**

Bimetal with set wood teeth for all wood, plasterboard and plastic materials. Outstanding tool life, high cutting quality and speed. Extremely robust, not affected by nails (up to diameter of approx. 4 mm) in wood, masonry etc. Wide shape for maximum cutting performance and long, straight cuts.

Width mm	Length mm	Mount	No. in pack pcs	Part number	£ List Price excl. VAT
50	50	SL	1	6 35 02 221 21 0	13.55
50	50	SL	3	6 35 02 221 22 0	38.62
50	50	SL	5	6 35 02 221 23 0	61.04
50	50	SL	10	6 35 02 221 24 0	115.27
50	50	SL	50	6 35 02 221 25 0	549.12
65	50	SL	1	6 35 02 228 21 0	12.63
65	50	SL	3	6 35 02 228 22 0	36.01
65	50	SL	5	6 35 02 228 23 0	56.86
65	50	SL	10	6 35 02 228 24 0	107.40
65	50	SL	50	6 35 02 228 25 0	511.70



**E-Cut long-life saw blade**

Bimetal with set wood teeth for all wood, plasterboard and plastic materials. Outstanding tool life, high cutting quality and speed. Extremely robust, not affected by nails (up to diameter of approx. 4 mm) in wood, masonry etc. Extra wide shape for maximum cutting performance and long, straight cuts.

Width mm	Length mm	Mount	No. in pack pcs	Part number	£ List Price excl. VAT
65	50	SLP	1	6 35 02 161 21 0	13.90
65	50	SLP	3	6 35 02 161 22 0	39.60
65	50	SLP	5	6 35 02 161 23 0	62.51
65	50	SLP	10	6 35 02 161 24 0	118.11
65	50	SLP	50	6 35 02 161 25 0	562.53



**E-Cut long-life saw blade**

Bimetal with set wood teeth for all wood, plasterboard and plastic materials. Outstanding tool life, high cutting quality and speed. Extremely robust, not affected by nails (up to diameter of approx. 4 mm) in wood, masonry etc. Long, narrow shape for large plunge depths. With waist for optimum cutting speed and good swarf removal.

Width mm	Length mm	Mount	No. in pack pcs	Part number	£ List Price excl. VAT
32	78	SLM	1	6 35 02 201 21 0	14.53
32	78	SLM	3	6 35 02 201 22 0	40.56
32	78	SLM	5	6 35 02 201 23 0	65.39
32	78	SLM	10	6 35 02 201 24 0	123.52
32	78	SLM	50	6 35 02 201 25 0	588.42



**E-Cut long-life saw blade**

Bimetal with set wood teeth for all wood, plasterboard and plastic materials. Outstanding tool life, high cutting quality and speed. Extremely robust, not affected by nails (up to diameter of approx. 4 mm) in wood, masonry etc. Long, wide shape for large plunge depths and effective working. With waist for optimum cutting speed and good swarf removal.

Width mm	Length mm	Mount	No. in pack pcs	Part number	£ List Price excl. VAT
42	78	SLM	1	6 35 02 203 21 0	15.09
42	78	SLM	3	6 35 02 203 22 0	42.11
42	78	SLM	5	6 35 02 203 23 0	67.93
42	78	SLM	10	6 35 02 203 24 0	128.28
42	78	SLM	50	6 35 02 203 25 0	611.31



**E-Cut standard saw blade**

Set teeth for all wood, plasterboard and plastic materials, high cutting quality and speed. Medium width, with waist for optimum cutting speed and good swarf removal.

Width mm	Length mm	Mount	No. in pack pcs	Part number	£ List Price excl. VAT
35	50	SL	1	6 35 02 133 21 0	9.96
35	50	SL	3	6 35 02 133 22 0	28.38
35	50	SL	5	6 35 02 133 23 0	44.81
35	34	SL	10	6 35 02 133 24 0	84.60
35	50	SL	50	6 35 02 133 25 0	403.22



**E-Cut standard saw blade**

Set teeth for all wood, plasterboard and plastic materials, high cutting quality and speed. Wide shape for maximum cutting performance and long, straight cuts.

Width mm	Length mm	Mount	No. in pack pcs	Part number	£ List Price excl. VAT
65	50	SLP	1	6 35 02 134 21 0	11.83
65	50	SLP	3	6 35 02 134 22 0	33.70
65	50	SLP	5	6 35 02 134 23 0	53.18
65	50	SLP	10	6 35 02 134 24 0	100.48
65	50	SLP	50	6 35 02 134 25 0	478.74



**E-Cut standard saw blade**

Set teeth for all wood, plasterboard and plastic materials, high cutting quality and speed. Long, narrow shape for large plunge depths. With waist for optimum cutting speed and good swarf removal.

Width mm	Length mm	Mount	No. in pack pcs	Part number	£ List Price excl. VAT
32	78	SLM	1	6 35 02 200 21 0	12.76
32	78	SLM	3	6 35 02 200 22 0	35.72
32	78	SLM	5	6 35 02 200 23 0	57.49
32	78	SLM	10	6 35 02 200 24 0	108.58
32	78	SLM	50	6 35 02 200 25 0	517.19



**E-Cut standard saw blade**

Set teeth for all wood, plasterboard and plastic materials, high cutting quality and speed. Long, wide shape for large plunge depths and effective working. With waist for optimum cutting speed and good swarf removal.

Width mm	Length mm	Mount	No. in pack pcs	Part number	£ List Price excl. VAT
42	78	SLM	1	6 35 02 202 21 0	13.30
42	78	SLM	3	6 35 02 202 22 0	37.10
42	78	SLM	5	6 35 02 202 23 0	59.83
42	78	SLM	10	6 35 02 202 24 0	112.95
42	78	SLM	50	6 35 02 202 25 0	536.48



**E-Cut standard saw blade curved**

Set teeth for all wood, plasterboard and plastic materials, high cutting quality and speed. Curved cutting geometry for optimum plunging and clean precise cut edges, especially on smooth surfaces.  
Narrow, with waist for optimum cutting speed and good swarf removal.

Width mm	Length mm	Mount	No. in pack pcs	Part number	£ List Price excl. VAT
35	55	SL	1	6 35 02 227 21 0	11.03
35	55	SL	3	6 35 02 227 22 0	31.42
35	55	SL	5	6 35 02 227 23 0	49.62
35	55	SL	10	6 35 02 227 24 0	93.72
35	55	SL	50	6 35 02 227 25 0	483.43



**E-Cut standard saw blade curved**

Set teeth for all wood, plasterboard and plastic materials, high cutting quality and speed. Curved cutting geometry for optimum plunging and clean precise cut edges, especially on smooth surfaces.  
Medium width for various uses.

Width mm	Length mm	Mount	No. in pack pcs	Part number	£ List Price excl. VAT
50	50	SL	1	6 35 02 226 21 0	11.50
50	50	SL	3	6 35 02 226 22 0	32.76
50	50	SL	5	6 35 02 226 23 0	51.73
50	50	SL	10	6 35 02 226 24 0	97.71
50	50	SL	50	6 35 02 226 25 0	465.56



**E-Cut standard saw blade curved**

Set teeth for all wood, plasterboard and plastic materials, high cutting quality and speed. Curved cutting geometry for optimum plunging and clean precise cut edges, especially on smooth surfaces.  
Wide shape for maximum cutting performance and long, straight cuts.

Width mm	Length mm	Mount	No. in pack pcs	Part number	£ List Price excl. VAT
65	50	SL	1	6 35 02 225 21 0	11.91
65	50	SL	3	6 35 02 225 22 0	33.95
65	50	SL	5	6 35 02 225 23 0	53.61
65	50	SL	10	6 35 02 225 24 0	101.26
65	50	SL	50	6 35 02 225 25 0	482.49



**E-Cut precision BIM saw blade**

Bimetal with double-row Japan teeth for all wooden materials, plasterboard and soft plastics. Improved tool life and robustness. The fastest cutting speed and maximum precision.  
Narrow, with waist for optimum cutting speed and good swarf removal.

Width mm	Length mm	Mount	No. in pack pcs	Part number	£ List Price excl. VAT
35	50	SL	1	6 35 02 205 21 0	14.37
35	50	SL	3	6 35 02 205 22 0	40.97
35	50	SL	5	6 35 02 205 23 0	65.90
35	50	SL	10	6 35 02 205 24 0	122.15
35	50	SL	50	6 35 02 205 25 0	581.94



**E-Cut precision BIM saw blade**

Bimetal with double-row Japan teeth for all wooden materials, plasterboard and soft plastics. Improved tool life and robustness. The fastest cutting speed and maximum precision.  
Medium width for various uses.

Width mm	Length mm	Mount	No. in pack pcs	Part number	£ List Price excl. VAT
50	50	SL	1	6 35 02 232 21 0	14.22
50	50	SL	3	6 35 02 232 22 0	40.53
50	50	SL	5	6 35 02 232 23 0	63.99
50	50	SL	10	6 35 02 232 24 0	120.87
50	50	SL	50	6 35 02 232 25 0	568.80



**E-Cut precision BIM saw blade**

Bimetal with double-row Japan teeth for all wooden materials, plasterboard and soft plastics. Improved tool life and robustness. The fastest cutting speed and maximum precision.  
Extra wide shape for maximum cutting performance and long, straight cuts.

Width mm	Length mm	Mount	No. in pack pcs	Part number	£ List Price excl. VAT
65	50	SLP	1	6 35 02 208 21 0	15.98
65	50	SLP	3	6 35 02 208 22 0	45.50
65	50	SLP	5	6 35 02 208 23 0	71.88
65	50	SLP	10	6 35 02 208 24 0	135.74
65	50	SLP	50	6 35 02 208 25 0	646.69
65	50	SL	1	6 35 02 229 21 0	13.10
65	50	SL	3	6 35 02 229 22 0	37.35
65	50	SL	5	6 35 02 229 23 0	58.97
65	50	SL	10	6 35 02 229 24 0	111.39
65	50	SL	50	6 35 02 229 25 0	530.74



**E-Cut precision saw blade**

Double-row Japan teeth for all wooden materials, plasterboard and soft plastics. The fastest cutting speed and maximum precision.  
Narrow, with waist for optimum cutting speed and good swarf removal.

Width mm	Length mm	Mount	No. in pack pcs	Part number	£ List Price excl. VAT
35	50	SL	1	6 35 02 126 21 0	13.04
35	50	SL	3	6 35 02 126 22 0	37.22
35	50	SL	5	6 35 02 126 23 0	59.92
35	50	SL	10	6 35 02 126 24 0	111.03
35	50	SL	50	6 35 02 126 25 0	528.84



**E-Cut precision saw blade**

Double-row Japan teeth for all wooden materials, plasterboard and soft plastics. The fastest cutting speed and maximum precision.  
Medium width for various uses.

Width mm	Length mm	Mount	No. in pack pcs	Part number	£ List Price excl. VAT
50	50	SL	1	6 35 02 233 21 0	12.93
50	50	SL	3	6 35 02 233 22 0	36.85
50	50	SL	5	6 35 02 233 23 0	58.19
50	50	SL	10	6 35 02 233 24 0	109.91
50	50	SL	50	6 35 02 233 25 0	517.20



**E-Cut precision saw blade**

Double-row Japan teeth for all wooden materials, plasterboard and soft plastics. The fastest cutting speed and maximum precision.  
Extra wide shape for maximum cutting performance and long, straight cuts.

Width mm	Length mm	Mount	No. in pack pcs	Part number	£ List Price excl. VAT
65	50	SLP	1	6 35 02 127 21 0	14.52
65	50	SLP	3	6 35 02 127 22 0	41.38
65	50	SLP	5	6 35 02 127 23 0	65.36
65	50	SLP	10	6 35 02 127 24 0	123.38
65	50	SLP	50	6 35 02 127 25 0	587.97
65	50	SL	1	6 35 02 230 21 0	12.63
65	50	SL	3	6 35 02 230 22 0	36.01
65	50	SL	5	6 35 02 230 23 0	56.86
65	50	SL	10	6 35 02 230 24 0	107.40
65	50	SL	50	6 35 02 230 25 0	511.70

Oscillating multi-tool



**E-Cut universal saw blade**

Bimetal with corrugated universal teeth. Wide range of applications for sheet metal up to 2 mm, aluminium profiles, copper pipes, wood, plasterboard and plastics. Narrow, with waist for optimum cutting speed and good swarf removal.

Width mm	Length mm	Mount	No. in pack pcs	Part number	£ List Price excl. VAT
28	60	SLP	1	6 35 02 151 21 0	14.52
28	60	SLP	3	6 35 02 151 22 0	41.37
28	60	SLP	5	6 35 02 151 23 0	65.32
28	60	SLP	10	6 35 02 151 24 0	123.40
28	50	SLP	50	6 35 02 151 25 0	587.99
28	55	SL	1	6 35 02 222 21 0	14.25
28	55	SL	3	6 35 02 222 22 0	40.66
28	55	SL	5	6 35 02 222 23 0	64.16
28	55	SL	10	6 35 02 222 24 0	121.19
28	55	SL	50	6 35 02 222 25 0	577.63



**E-Cut universal saw blade**

Bimetal with corrugated universal teeth. Wide range of applications for sheet metal up to 2 mm, aluminium profiles, copper pipes, wood, plasterboard and plastics. Medium width, with waist for optimum cutting speed and good swarf removal.

Width mm	Length mm	Mount	No. in pack pcs	Part number	£ List Price excl. VAT
44	60	SLP	1	6 35 02 152 21 0	15.15
44	60	SLP	3	6 35 02 152 22 0	43.14
44	60	SLP	5	6 35 02 152 23 0	68.11
44	60	SLP	10	6 35 02 152 24 0	128.67
44	60	SLP	50	6 35 02 152 25 0	613.01
44	55	SL	1	6 35 02 223 21 0	14.81
44	55	SL	3	6 35 02 223 22 0	42.23
44	55	SL	5	6 35 02 223 23 0	66.68
44	55	SL	10	6 35 02 223 24 0	125.94
44	55	SL	50	6 35 02 223 25 0	600.06



**E-Cut fine saw blade**

Bimetal with fine teeth for sheet metal up to 2 mm, aluminium profiles, copper pipes. Also for fibreglass-reinforced plastic and other hard plastics. Extremely precise cuts which are very easy to control with particularly thin cutting line. Narrow, with waist for optimum cutting speed and good swarf removal.

Width mm	Length mm	Mount	No. in pack pcs	Part number	£ List Price excl. VAT
30	50	SL	1	6 35 02 157 21 0	9.76
30	50	SL	3	6 35 02 157 22 0	27.79
30	50	SL	5	6 35 02 157 23 0	43.89
30	50	SL	10	6 35 02 157 24 0	82.84
30	50	SL	50	6 35 02 157 25 0	395.03



**Carbide saw blade**

Open teeth for perfect, clean cut edges in carbon fibre-reinforced plastic/fibreglass-reinforced plastic materials without delamination. Distortion-free, long, straight cuts at high cutting speed and with precision. Extra thin version. Cutting width approx. 1.2 mm. Segmented, ideal for working in corners and on edges without overcutting.

Ø mm	Mount	Part number	£ List Price excl. VAT
90	SLP	6 35 02 187 21 0	38.97



**Carbide saw blade**

Open teeth for perfect, clean cut edges in carbon fibre-reinforced plastic/fibreglass-reinforced plastic materials without delamination. Distortion-free, long, straight cuts at high cutting speed and with precision. Extra thin version. Cutting width approx. 1.2 mm.

Ø mm	Mount	Part number	£ List Price excl. VAT
105	SLM	6 35 02 215 21 0	44.71



**Diamond-coated saw blade**

Open teeth for perfect, clean cut edges in carbon fibre-reinforced plastic/fibreglass-reinforced plastic materials without delamination. Distortion-free, long, straight cuts at high cutting speed and with precision. Diamond coating for outstanding service life. Extra thin version. Cutting width approx. 1.2 mm. Segmented, ideal for working in corners and on edges without overcutting.

Ø mm	Mount	Part number	£ List Price excl. VAT
90	SLP	6 35 02 188 21 0	79.08
105	SLM	6 35 02 220 21 0	107.73



**E-Cut carbide saw blade**

Gentle sawing with perfect, clean cut edges in carbon fibre-reinforced plastic/fibreglass-reinforced plastic materials without delamination. Particularly well suited to precise cut-outs and short cuts. Precise working into the corners and on edges.

Width mm	Length mm	Mount	Part number	£ List Price excl. VAT
35	50	SLP	6 35 02 191 21 0	27.50



**E-Cut diamond saw blade**

Diamond coating for outstanding service life. Gentle sawing with perfect, clean cut edges in carbon fibre-reinforced plastic/fibreglass-reinforced plastic materials without delamination. Particularly well suited to precise cut-outs and short cuts. Precise working into the corners and on edges.

Width mm	Length mm	Mount	Part number	£ List Price excl. VAT
44	60	SLM	6 35 02 204 21 0	48.31
35	50	SLP	6 35 02 193 21 0	44.71



**Segment saw blade**

For cutting out putty-mounted isolation glass.

Mount	No. in pack pcs	Part number	£ List Price excl. VAT
SLM	2	6 39 03 244 22 0	63.03



**Best of Renovation accessory set**

34-part accessory set for a wide range of renovation jobs at a special price in a practical plastic storage box. Universal use for sawing, sanding, cutting and much more. Attractive savings over purchasing the items individually. Contents: E-CUT long-life saw blades (1 x 10 mm and 1 x 20 mm), E-CUT long-life saw blades (3 x 35 and 3 x 65 mm), E-CUT universal saw blades (1 x 28 mm and 1 x 44 mm), 1 segmented HSS saw blade, diameter 85 mm, 1 segmented carbide saw blade, diameter 90 mm, 1 carbide file 10 mm, 1 rigid short stopper knife, 1 unperforated triangular sanding pad, with sanding sheets 3 each of 60, 80, 120, 180 grit, 1 backing pad, diameter 115 mm with sanding sheets, 2 each of 60, 80, 180 grit.

Mount	Part number	£ List Price excl. VAT
SLP	3 52 22 942 06 0	170.32



**Set of accessories for renovating floors**

3-part set of accessories for numerous jobs associated with renovating floors. Can be used universally for numerous sawing jobs such as shortening a door jamb, for accurate machining of parquet boards and cutting skirting boards once fitted. But also for removing adhesive residue, elastic sealing materials or leftover carpets cleanly and in their entirety. Attractive savings over purchasing the items individually. With Starlock mounting, suitable for all popular oscillating multi-tools on the market. Also compatible with Bosch, Makita, Metabo, Ridgid, Skil and many more. Contents: 1 x HSS saw blade, segmented, 85 mm in diameter, 1 x E-CUT long-life saw blade 35 mm, 1 x fixed, short spatula.

Mount	Part number	£ List Price excl. VAT
SL	3 52 22 952 22 0	40.76



**Set of accessories for renovating windows**

15-part set of accessories for the most common jobs encountered when repairing and renovating wooden windows. Can be used universally for grinding close the edge in corners and edges without kick-back. Remove old brittle putty or glass retaining strips without the risk of breaking glass and for sawing old timber materials, including those with nails. Attractive savings over purchasing the items individually. With Starlock mounting, suitable for all popular oscillating multi-tools on the market. Also compatible with Bosch, Makita, Metabo, Ridgid, Skil and many more. Contents: 1 x triangular sanding pad (80 mm) with sanding sheets (3 each of grit 60, 80, 120, 180), 1 x HSS saw blade, segmented, 85 mm in diameter, 1 x E-Cut long-life saw blade, 35 mm in diameter.

Mount	Part number	£ List Price excl. VAT
SL	3 52 22 952 23 0	40.76



**Universal set of accessories**

15-part set of accessories. Ideal choice of accessories for all common renovation and repair jobs around the house. Can be used universally for grinding close the edge in corners and edges without kick-back. For sawing all timber materials, including those with nails, or specially for sawing soft materials without overcutting into the edge area. Attractive savings over purchasing the items individually. With Starlock mounting, suitable for all popular oscillating multi-tools on the market. Also compatible with Bosch, Makita, Metabo, Ridgid, Skil and many more. Contents: 1 x triangular sanding pad (80 mm) with sanding sheets (3 each of grit 60, 80, 120, 180), 1 x E-Cut long-life saw blade 50 mm, 1 x saw blade, segmented, 85 mm in diameter.

Mount	Part number	£ List Price excl. VAT
SL	3 52 22 952 24 0	40.76



**Sanitary set of accessories**

3-part set of accessories for many common renovation and repair jobs in sanitary facilities. Cut out tile joints quickly and cleanly, getting right into the corners and edges without overcutting when undertaking partial repairs on individual tiles. Rasp off tile adhesive before laying new tiles. Replace tile joints in their entirety or saw off surplus metal installations flush with the wall and many other tasks. Attractive savings over purchasing the items individually. With Starlock mounting, suitable for all popular oscillating multi-tools on the market. Also compatible with Bosch, Makita, Metabo, Ridgid, Skil and many more. Contents: 1 x carbide rasp (80 mm), 1 x carbide saw blade, segmented, diameter 75 mm, 1 x E-Cut universal saw blade 28 mm.

Mount	Part number	£ List Price excl. VAT
SL	3 52 22 952 25 0	51.21

**Grinding**



**Best of Sanding accessory set**

61-part accessory set for all sanding work on corners and edges as well as medium to large surfaces in a practical plastic storage box. Attractive savings over purchasing the items individually. Contents: 1 x triangular unperforated sanding pad, with sanding sheets, 10 each of 60, 80, 120, 180 grit, 1 backing pad 115 mm in diameter with sanding sheets, 6 each of 60, 80, 180 grit, 1 triangular carbide rasp.

Mount	Part number	£ List Price excl. VAT
SLP	3 52 22 942 04 0	62.15



**Sanding pad set, unperforated**

Standard version. Plastic carrier plate for preventing damage and marks on the workpiece. Triangular shape, hook and loop fastening.

Mount	No. in pack pcs	Part number	£ List Price excl. VAT
SL	2	6 38 06 129 22 0	10.76



**Sanding pad set, flat**

For very narrow, flat openings (e.g. slats on cupboards, window shutters). Plastic carrier plate for preventing damage and marks on the workpiece. Triangular shape, flat version, hook and loop fastening.

Mount	No. in pack pcs	Part number	£ List Price excl. VAT
SL	2	6 38 06 142 22 0	14.56



**Supersoft sanding pad**

For special areas of application such as touching up aluminium rims and paint repairs. Plastic carrier plate for preventing damage and marks on the workpiece. Only use with "Sanding sheets, super-soft". Triangular shape, super-soft version, hook and loop fastening.

Mount	No. in pack pcs	Part number	£ List Price excl. VAT
SL	2	6 38 06 141 22 0	14.56



**Set of sanding sheets**

50 sanding sheets of various grits for the universal use of coarse to fine sanding on virtually all materials. High sanding capacity, little clogging and long service life guaranteed thanks to corundum abrasive grit and full bonding with artificial resins. Content: sanding sheets, 10 each of grit 60, 80, 120, 180 and 240, non-perforated, with hook and loop fastening. Better value than buying items separately.

Part number	£ List Price excl. VAT
6 37 17 082 03 3	17.48



**Sanding sheets**

High sanding capacity, little clogging and long service life guaranteed thanks to corundum abrasive grit and full bonding with artificial resins. For universal use on virtually all materials. Non-perforated, hook and loop fastening.

Grain	No. in pack pcs	Part number	£ List Price excl. VAT
36	5	6 37 17 086 04 8	4.53
40	5	6 37 17 081 04 6	4.21
60	5	6 37 17 082 04 9	4.21
80	5	6 37 17 083 04 3	4.21
100	5	6 37 17 084 04 1	4.21
120	5	6 37 17 085 04 5	4.21
150	5	6 37 17 087 04 2	4.21
180	5	6 37 17 088 04 0	4.21
220	5	6 37 17 089 04 4	4.21
240	5	6 37 17 090 04 6	4.21
36	50	6 37 17 086 01 0	25.37
40	50	6 37 17 081 01 8	17.48
60	50	6 37 17 082 01 1	17.48
80	50	6 37 17 083 01 5	17.48
100	50	6 37 17 084 01 3	17.48
120	50	6 37 17 085 01 7	17.48
150	50	6 37 17 087 01 4	17.48
180	50	6 37 17 088 01 2	17.48
220	50	6 37 17 089 01 6	17.48
240	50	6 37 17 090 01 8	17.48



**Sanding sheets, zirconium**

Excellent sanding capacity on extremely hard surfaces such as varnish (e.g. parquet paint) or metal. The sanding sheet for all floor covering work. Extremely sturdy paper quality thanks to extremely tough full bonding with artificial resins and high-quality zirconium corundum coating. Non-perforated, hook and loop fastening.

Grain	No. in pack pcs	Part number	£ List Price excl. VAT
40	35	6 37 17 243 01 0	16.68
60	35	6 37 17 244 01 0	16.68
80	35	6 37 17 245 01 0	16.68



**Supersoft sanding sheets**

Special sanding sheets for machining aluminium rims, performing touch-up work on dust inclusions, dealing with paint runs, overspray on wood, plastic, metal, etc. Only to be used in conjunction with the sanding pad 6 38 06 141 02 6. Non-perforated, hook and loop fastening.

Grain	No. in pack pcs	Part number	£ List Price excl. VAT
240	50	6 37 17 126 01 5	18.26
320	50	6 37 17 127 01 9	18.26
400	50	6 37 17 128 01 7	18.26
500	50	6 37 17 179 01 6	18.26

Oscillating multi-tool



**Stone sanding sheets**

Specially for working with natural and artificial stone. Available up to grit 800 for a perfect surface finish in fine sanding. Non-perforated, hook and loop fastening.

Grain	No. in pack pcs	Part number	£ List Price excl. VAT
40	50	6 37 17 120 01 4	20.03
80	50	6 37 17 121 01 3	18.39
120	50	6 37 17 122 01 6	17.89
220	50	6 37 17 123 01 0	17.89
320	50	6 37 17 124 01 8	17.89
400	50	6 37 17 125 01 2	17.89
600	50	6 37 17 175 01 7	17.89
800	50	6 37 17 176 01 0	17.89



**Sanding finger**

For use in very narrow and deep places, in channels, grooves, openings and folds. Also in mould-making, on concave forms and in convex forms. Plastic carrier plate for preventing damage and marks on the workpiece. Finger shape, hook and loop fastening.

Mount	No. in pack pcs	Part number	£ List Price excl. VAT
SL	2	6 38 06 159 22 0	11.55



**Sanding sheets for sanding fingers**

With Velcro rapid attachment, fully bonded with artificial resin, high sanding capacity, corundum. For use on: wood, metal, soldered joints, fibreglass, plastic, paint, filler, leather. Pack of 20

Grain	No. in pack pcs	Part number	£ List Price excl. VAT
40	20	6 37 17 184 01 2	5.85
60	20	6 37 17 185 01 6	5.85
80	20	6 37 17 186 01 9	5.85
100	20	6 37 17 187 01 3	5.85
120	20	6 37 17 188 01 1	5.85
150	20	6 37 17 189 01 5	5.85
180	20	6 37 17 190 01 7	5.85
220	20	6 37 17 191 01 6	5.85
240	20	6 37 17 192 01 9	5.85



**Profile grinding set**

22-part set for sanding in grooves and on outside radii. Contents: 1 holder with 6 different profile inserts. 1 x V-form for 90° angle, 1 x trapezium form for tongue-and-groove connections, 1 x straight form for profiles, 1 x convex form (large), 1 x concave and 1 x convex form (small) and sanding sheets, 5 each of 80, 120 and 180 grit.

Mount	Part number	£ List Price excl. VAT
SLP	6 38 10 031 01 0	44.30



**Sandpaper for profile sanding set**

High sanding capacity, little clogging and long service life guaranteed thanks to corundum abrasive grit and full bonding with artificial resins. For universal use on virtually all materials, non-perforated.

Grain	No. in pack pcs	Part number	£ List Price excl. VAT
80	25	6 37 17 217 01 6	9.43
120	25	6 37 17 218 01 4	9.43
180	25	6 37 17 219 01 8	9.43



**Sanding pad set, perforated**

Standard version for sanding with dust extraction. Plastic carrier plate for preventing damage and marks on the workpiece. Triangular shape, perforated version, hook and loop fastening.

Mount	No. in pack pcs	Part number	£ List Price excl. VAT
SL	2	6 38 06 136 22 0	16.50



**Set of sanding sheets**

50 sanding sheets of various grits for the universal use of coarse to fine sanding on virtually all materials. High sanding capacity, little clogging and long service life guaranteed thanks to corundum abrasive grit and full bonding with artificial resins. Content: sanding sheets, 10 each of grit 60, 80, 120, 180, 240, perforated, for use with perforated sanding pad and dust extraction, hook and loop fastening. Better value than buying items separately.

Part number	£ List Price excl. VAT
6 37 17 109 03 5	18.73



**Sanding sheets, perforated**

High sanding capacity, little clogging and long service life guaranteed thanks to corundum abrasive grit and full bonding with artificial resins. For universal use on virtually all materials. Perforated, for use with perforated sanding pad and dust extraction, hook and loop fastening.

Grain	No. in pack pcs	Part number	£ List Price excl. VAT
36	5	6 37 17 107 04 9	5.40
40	5	6 37 17 108 04 7	4.53
60	5	6 37 17 109 04 1	4.53
80	5	6 37 17 110 04 3	4.53
100	5	6 37 17 111 04 2	4.53
120	5	6 37 17 112 04 5	4.53
150	5	6 37 17 113 04 9	4.53
180	5	6 37 17 114 04 7	4.53
220	5	6 37 17 115 04 1	4.53
240	5	6 37 17 116 04 4	4.53
36	50	6 37 17 107 01 1	29.11
40	50	6 37 17 108 01 9	18.73
60	50	6 37 17 109 01 3	18.73
80	50	6 37 17 110 01 5	18.73
100	50	6 37 17 111 01 4	18.73
120	50	6 37 17 112 01 7	18.73
150	50	6 37 17 113 01 1	18.73
180	50	6 37 17 114 01 9	18.73
220	50	6 37 17 115 01 3	18.73
240	50	6 37 17 116 01 6	18.73



**Sanding sheets, zirconium**

Excellent sanding capacity on extremely hard surfaces such as varnish (e.g. parquet paint) or metal. The sanding sheet for all floor covering work. Extremely sturdy paper quality thanks to extremely tough full bonding with artificial resins and high-quality zirconium corundum coating. Perforated, for use with perforated sanding pad and dust extraction, hook and loop fastening.

Grain	No. in pack pcs	Part number	£ List Price excl. VAT
40	35	6 37 17 236 01 0	17.88
60	35	6 37 17 237 01 0	17.88
80	35	6 37 17 238 01 0	17.88



**Sanding set**

For the efficient sanding of edge and corner areas and medium-sized surfaces. The alternative to eccentric or random sanders. No kick-back effect at edges. Easy to use, very good sanding capacity. Plastic carrier plate prevents damage and marks on the workpiece.

Scope of supply: 1 large perforated triangular sanding pad (edge length 130 mm), with perforated sanding sheets, 2 each of grit 60, 80, 180.

Mount	Part number	£ List Price excl. VAT
SLP	6 38 06 204 21 0	28.49



**Sanding sheets, perforated**

Compatible with large triangular sanding pad with 130 mm edge length.

High sanding capacity, little clogging and long service life guaranteed thanks to corundum abrasive grit and full bonding with artificial resins. For universal use on virtually all materials. Perforated, for use with perforated sanding pad and dust extraction, hook and loop fastening.

Grain	No. in pack pcs	Part number	£ List Price excl. VAT
40	16	6 37 17 292 02 0	10.26
60	16	6 37 17 293 02 0	10.26
80	16	6 37 17 294 02 0	10.26
120	16	6 37 17 295 02 0	10.26
180	16	6 37 17 296 02 0	10.26
240	16	6 37 17 297 02 0	10.26



**Set of sanding sheets**

16 sanding sheets of various grits for the universal use of coarse to fine sanding on virtually all materials. High sanding capacity, little clogging and long service life guaranteed thanks to corundum abrasive grit and full bonding with artificial resins. Content: sanding sheets for large triangular sanding pad (edge length 130 mm), 4 each of grit 60, 80, 120, 180, perforated, for use with and without dust extraction, hook and loop fastening. Better value than buying items separately.

Part number	£ List Price excl. VAT
3 52 22 952 10 0	10.24



**Sanding sheets, zirconium**

Compatible with large triangular sanding pad with 130 mm edge length.

Excellent sanding capacity on extremely hard surfaces such as varnish (e.g. parquet paint) or metal. The sanding sheet for all floor covering work. Extremely sturdy paper quality thanks to extremely tough full bonding with artificial resins and high-quality zirconium corundum coating. Perforated, for use with perforated sanding pad and dust extraction, hook and loop fastening.

Grain	No. in pack pcs	Part number	£ List Price excl. VAT
40	12	6 37 17 298 01 0	17.10
60	12	6 37 17 299 01 0	17.10
80	12	6 37 17 300 01 0	17.10



**Sanding sheet set, zirconium**

12 sanding sheets with excellent sanding capacity on extremely hard surfaces such as varnish (e.g. parquet paint) or metal. The sanding sheet for all floor covering work. Extremely sturdy paper quality thanks to extremely tough full bonding with artificial resins and high-quality zirconium corundum coating. Content: sanding sheets for large triangular sanding pad (edge length 130 mm), 4 each of grit 40, 60, 80, perforated, for use with and without dust extraction, hook and loop fastening. Better value than buying items separately.

Part number	£ List Price excl. VAT
3 52 22 952 11 0	19.16



**Sanding set**

For quickly and cost-effectively sanding medium-sized surfaces. The alternative to eccentric or random sanders. No kick-back effect at edges. Easy to use, very good sanding capacity. Can be used with or without dust extraction. Plastic carrier plate for preventing damage and marks on the workpiece.

Round shape, perforated version, hook and loop fastening. Scope of supply: 1 backing pad diameter 115 mm, with perforated sanding sheets, 2 each of grit 60, 80, 180.

Ø mm	Mount	Part number	£ List Price excl. VAT
115	SLP	6 38 06 195 21 0	25.42



**Set of sanding sheets**

16 sanding sheets of various grits for the universal use of coarse to fine sanding on virtually all materials. High sanding capacity, little clogging and long service life guaranteed thanks to corundum abrasive grit and full bonding with artificial resins. Content: sanding sheets, 4 each of grit 60, 80, 120, 180, 115 mm diameter, perforated, for use with and without dust extraction, hook and loop fastening. Better value than buying items separately.

Part number	£ List Price excl. VAT
6 37 17 227 01 0	11.56



**Sanding sheets**

High sanding capacity, little clogging and long service life guaranteed thanks to corundum abrasive grit and full bonding with artificial resins. For universal use on virtually all materials. 115 mm diameter, perforated, for use with and without dust extraction, hook and loop fastening.

Grain	No. in pack pcs	Part number	£ List Price excl. VAT
40	16	6 37 17 230 02 0	11.56
60	16	6 37 17 227 02 0	11.56
80	16	6 37 17 228 02 0	11.56
120	16	6 37 17 229 01 0	11.56
180	16	6 37 17 231 02 0	11.56
240	16	6 37 17 232 01 0	11.56



**Sanding sheets, zirconium**

Excellent sanding capacity on extremely hard surfaces such as varnish (e.g. parquet paint) or metal. The sanding sheet for all floor covering work. Extremely sturdy paper quality thanks to extremely tough full bonding with artificial resins and high-quality zirconium corundum coating. 115 mm diameter, perforated, for use with and without dust extraction, hook and loop fastening.

Grain	No. in pack pcs	Part number	£ List Price excl. VAT
40	12	6 37 17 233 01 0	19.67
60	12	6 37 17 234 01 0	19.67
80	12	6 37 17 235 01 0	19.67



**Sanding sheet set, zirconium**

12 sanding sheets with excellent sanding capacity on extremely hard surfaces such as varnish (e.g. parquet paint) or metal. The sanding sheet for all floor covering work. Extremely sturdy paper quality thanks to extremely tough full bonding with artificial resins and high-quality zirconium corundum coating. Content: sanding sheets, 4 each of grit 40, 60, 80, 115 mm diameter, perforated, for use with and without dust extraction, hook and loop fastening. Better value than buying items separately.

Part number	£ List Price excl. VAT
6 37 17 233 02 0	19.67

**Cutting, filing**



**Carbide saw blade**

For cutting out damaged tile joints. Also for cutting slots in plaster, porous concrete and similar building materials and for cleaning and reworking deck joints. Not suited to very hard epoxy resin or cement joints. The cost-effective alternative to diamond tools.

Segmented, ideal for working in corners and on edges without overcutting. Cutting width approx. 2.2 mm.

Ø mm	Mount	No. in pack pcs	Part number	£ List Price excl. VAT
75	SL	1	6 35 02 118 21 0	24.82
75	SL	5	6 35 02 118 23 0	111.72
90	SLP	1	6 35 02 169 21 0	29.49
90	SLP	5	6 35 02 169 23 0	132.69



**Carbide saw blade**

For cutting out damaged tile joints. Also for cutting slots in plaster, porous concrete and similar building materials and for cleaning and reworking deck joints. Not suited to very hard epoxy resin or cement joints. The cost-effective alternative to diamond tools.

Extra thin version. Cutting width approx. 1.2 mm. Segmented, ideal for working in corners and on edges without overcutting.

Ø mm	Mount	No. in pack pcs	Part number	£ List Price excl. VAT
75	SL	1	6 35 02 125 21 0	24.82
75	SL	5	6 35 02 125 23 0	111.72
90	SLP	1	6 35 02 170 21 0	30.36
90	SLP	5	6 35 02 170 23 0	136.61

Oscillating  
multi-tool



**Carbide saw blade**

For cutting out very narrow marble, epoxy resin and trass joints. Not suited to very hard epoxy resin or cement joints. The cost-effective alternative to diamond tools. Extra thin version. Cutting width approx. 1.2 mm.

Ø mm	Mount	No. in pack pcs	Part number	£ List Price excl. VAT
105	SLM	5	6 35 02 214 23 0	165.91
105	SLM	1	6 35 02 214 21 0	36.87



**Carbide saw blade**

For cutting out marble, epoxy resin and trass joints. Not suited to very hard epoxy resin or cement joints. The cost-effective alternative to diamond tools. Cutting width approx. 2,2 mm.

Ø mm	Mount	No. in pack pcs	Part number	£ List Price excl. VAT
105	SLM	1	6 35 02 213 21 0	36.87
105	SLM	5	6 35 02 213 23 0	165.38



**Carbide saw blade**

For cutting out very narrow marble, epoxy resin and trass joints. Not suited to very hard epoxy resin or cement joints. The cost-effective alternative to diamond tools. Extra thin version. Cutting width approx. 1.2 mm. Segmented, ideal for working in corners and on edges without overcutting.

Mount	No. in pack pcs	Part number	£ List Price excl. VAT
SLM	5	6 39 03 240 23 0	169.22
SLM	1	6 39 03 240 21 0	37.60



**Carbide saw blade**

For cutting out marble, epoxy resin and trass joints. Not suited to very hard epoxy resin or cement joints. The cost-effective alternative to diamond tools. Segmented, ideal for working in corners and on edges without overcutting. Cutting width approx. 2.2 mm.

Mount	No. in pack pcs	Part number	£ List Price excl. VAT
SLM	1	6 39 03 241 21 0	37.60
SLM	5	6 39 03 241 23 0	169.22



**Diamond-coated saw blade**

For cutting out marble, epoxy resin and trass joints. Excellent service life. Also suited to very hard epoxy resin or cement joints. The right choice for frequent use and challenging jobs. Extra thin version. Cutting width approx. 1.2 mm. Segmented, ideal for working in corners and on edges without overcutting.

Ø mm	Mount	No. in pack pcs	Part number	£ List Price excl. VAT
75	SL	1	6 35 02 216 21 0	52.57
75	SL	5	6 35 02 216 23 0	236.54
90	SLP	1	6 35 02 217 21 0	62.15
90	SLP	5	6 35 02 217 23 0	279.67



**Diamond-coated saw blade**

For cutting out marble, epoxy resin and trass joints. Excellent service life. Also suited to very hard epoxy resin or cement joints. The right choice for frequent use and challenging jobs. Segmented, ideal for working in corners and on edges without overcutting. Cutting width approx. 2.2 mm.

Ø mm	Mount	No. in pack pcs	Part number	£ List Price excl. VAT
75	SL	1	6 35 02 114 21 0	52.57
75	SL	5	6 35 02 114 23 0	236.54
90	SLP	1	6 35 02 166 21 0	62.15
90	SLP	5	6 35 02 166 23 0	279.67



**Diamond-coated saw blade**

For cutting out marble, epoxy resin and trass joints. Excellent service life. Also suited to very hard epoxy resin or cement joints. The right choice for frequent use and challenging jobs. Extra thin version. Cutting width approx. 1.2 mm.

Ø mm	Mount	No. in pack pcs	Part number	£ List Price excl. VAT
105	SLM	1	6 35 02 219 21 0	94.70
105	SLM	5	6 35 02 219 23 0	426.14



**Diamond-coated saw blade**

For cutting out marble, epoxy resin and trass joints. Excellent service life. Also suited to very hard epoxy resin or cement joints. The right choice for frequent use and challenging jobs. Cutting width approx. 2,2 mm.

Ø mm	Mount	No. in pack pcs	Part number	£ List Price excl. VAT
105	SLM	1	6 35 02 218 21 0	94.70
105	SLM	5	6 35 02 218 23 0	426.14



**Diamond-coated saw blade**

For cutting out marble, epoxy resin and trass joints. Excellent service life. Also suited to very hard epoxy resin or cement joints. The right choice for frequent use and challenging jobs. Extra thin version. Cutting width approx. 1.2 mm. Segmented, ideal for working in corners and on edges without overcutting.

Mount	No. in pack pcs	Part number	£ List Price excl. VAT
SLM	5	6 39 03 242 23 0	314.27
SLM	1	6 39 03 242 21 0	69.84



**Diamond-coated saw blade**

For cutting out marble, epoxy resin and trass joints. Excellent service life. Also suited to very hard epoxy resin or cement joints. The right choice for frequent use and challenging jobs. Segmented, ideal for working in corners and on edges without overcutting. Cutting width approx. 2.2 mm.

Mount	No. in pack pcs	Part number	£ List Price excl. VAT
SLM	1	6 39 03 243 21 0	69.84
SLM	5	6 39 03 243 23 0	314.27



**Carbide rasp**

For rough sanding of fillers, tile adhesive, concrete, stone and wood. Triangular shape, edge length of 80 mm, perforated, can also be used with dust extraction.

Mount	Part number	£ List Price excl. VAT
SL	6 37 31 001 21 0	24.63



**Carbide rasp**

For rough sanding of fillers, tile adhesive, concrete, stone and wood. For use in very narrow and deep places, in channels, grooves, openings and folds. Also in mould-making, on concave forms and in convex forms and for artistic work. Finger shape, coating on both sides.

Mount	Part number	£ List Price excl. VAT
SLP	6 37 31 002 21 0	33.83



**Carbide rasp**

For rough sanding of fillers, tile adhesive, concrete, stone and wood. For particularly good cutting speed and efficient machining of several square metres. Triangular shape, large version, edge length of 110 mm, perforated, can also be used with dust extraction.

Mount	Part number	£ List Price excl. VAT
SLM	6 37 31 006 21 0	29.80



**Tile joint cleaner**

For quickly and cost-effectively cleaning very dirty tile joints. The alternative to a costly, complete renovation. Suitable for all widths of tile joint.

Mount	No. in pack pcs	Part number	£ List Price excl. VAT
SLP	2	6 37 19 011 22 0	25.31





**Cleaning block**

Rhombus for cleaning the carbide tools and diamond-coated tools.

Part number	£ List Price excl. VAT
6 37 19 007 01 0	22.68



**Carbide file**

For deburring and filing on CFRP, fibreglass-reinforced plastic, plastics and wood. Especially suitable for cutting out small recesses.

Width mm	Length mm	Mount	Part number	£ List Price excl. VAT
10	30	SLP	6 37 06 019 21 0	19.18



**Saw and file set FMM**

Ideal combination for cutting small recesses and working in tight spots, e.g. for numerous installation jobs, switch installation, model-building and more.

Supplied: E-CUT long-life saw blade, 1 each of 10 mm and 20 mm, 1 carbide file 10 mm.

Mount	Part number	£ List Price excl. VAT
SLP	3 52 22 952 02 0	25.71



**Cutting tool**

For making grooves in rigid foam panels for 1/2" and 3/4" hot water pipes and for empty pipes for electrical installation. Automatic fixing of laid pipes. Simple, quick and safe to use. StarlockMax fitting, can be used on all multi-function tools with suitable fitting. With adapter, suitable for all FEIN SUPERCUT before 04/16 too.

Width mm	Immersion Ø mm	Mount	No. in pack pcs	Part number	£ List Price excl. VAT
50	22	SLM	2	6 39 03 248 22 0	50.15



**Cutting tool**

For making grooves in rigid foam panels for electric cables. StarlockMax fitting, can be used on all multi-function tools with suitable fitting. With adapter, suitable for all FEIN SUPERCUT before 04/16 too.

Width mm	Immersion Ø mm	Mount	No. in pack pcs	Part number	£ List Price excl. VAT
50	12	SLM	2	6 39 03 247 22 0	54.45



**Cutting tool**

For making grooves in rigid foam panels for electrical, wall and underfloor heating. StarlockMax fitting, can be used on all multi-function tools with suitable fitting. With adapter, suitable for all FEIN SUPERCUT before 04/16 too.

Cutting depth mm	Width mm	Cutting width mm	Mount	No. in pack pcs	Part number	£ List Price excl. VAT
6,5	50	13	SLM	2	6 39 03 246 22 0	50.15



**Diamond cleaning knife**

For cleaning mortar flanks before filling them in again. Straight. Width 31 mm, cutting depth 60 mm.

Mount	No. in pack pcs	Part number	£ List Price excl. VAT
SLM	5	6 39 03 237 23 0	330.33
SLM	1	6 39 03 237 21 0	73.39

**Cutting, scraping**



**Multi-function knife**

For cutting carpet, PVC floors, cardboard, bitumen shingles and roofing fabric. With three cutting surfaces.

Mount	No. in pack pcs	Part number	£ List Price excl. VAT
SL	1	6 39 03 251 21 0	20.95
SL	5	6 39 03 251 23 0	94.28



**Flexible Scraper Blade**

Short version. For removing silicone or acrylic joints in bathrooms and removing stickers.

Mount	Part number	£ List Price excl. VAT
SL	6 39 03 165 21 0	8.05



**Fixed Scraper Blade**

Short version. For removing stubborn old paint, adhesive residues, carpets, tile adhesives and coats of underseal.

Mount	Part number	£ List Price excl. VAT
SL	6 39 03 226 21 0	14.49



**Fixed Scraper Blade**

Long version. For removing stubborn old paint, adhesive residues, carpets, tile adhesives and coats of underseal.

Mount	Part number	£ List Price excl. VAT
SLP	6 39 03 234 21 0	14.99



**Cutting blade**

Mushroom-shaped, for cutting silicone and soft putty material and for separating insulation glass units.

Mount	No. in pack pcs	Part number	£ List Price excl. VAT
SL	5	6 39 03 245 23 0	26.74



**Cutting blade**

For cutting away panelled deck sealant materials quickly and safely. Also ideal for difficult areas such as cabins, rails, gunwales, cleats, and curves.

Blade width mm	Mount	Part number	£ List Price excl. VAT
3	SLP	6 39 03 200 21 0	32.85
4	SLP	6 39 03 201 21 0	32.85
5	SLP	6 39 03 202 21 0	32.85
6	SLP	6 39 03 233 21 0	32.85



**Cutting blade**

Universal blade for virtually all expansion joints. Straight. Width 30 mm, cutting depth 60 mm.

Mount	No. in pack pcs	Part number	£ List Price excl. VAT
SLM	5	6 39 03 236 23 0	21.30



**Cutting blade**

Straight, long shape, for deep joints.

Cutting depth mm	Mount	No. in pack pcs	Part number	£ List Price excl. VAT
70	SLM	5	6 39 03 239 23 0	68.37



**Cutting blade**

Straight, very long shape, for very deep joints.

Cutting depth mm	Mount	No. in pack pcs	Part number	£ List Price excl. VAT
90	SLM	1	6 39 03 238 21 0	21.40



**HSS circular knife**

For universal cutting work in leather, plastic sheets, roofing fabric, cork etc.

Ø mm	Mount	Part number	£ List Price excl. VAT
100	SLP	6 39 03 235 21 0	53.04

**Cleaning, polishing**



**Bristle fleece**

Bristle fleece for cleaning boat decks or cleaning/polishing anti-slip structures.

No. in pack pcs	Part number	£ List Price excl. VAT
2	6 37 23 031 01 0	11.09

Oscillating multi-tool



**Felt polishing pad**

For polishing up metal parts, and for polishing and decorative polishing of stone and stone products. Can also be used to work with gelcoats on boats. Plastic carrier plate for preventing damage and marks on the workpiece. Burnishing compounds for the respective material are available from specialist retailers.

Mount	No. in pack pcs	Part number	£ List Price excl. VAT
SL	2	6 38 06 140 22 0	29.18



**Felt polishing pad**

Felt polishing pad for polishing boat decks (gelcoat), chrome, stainless steel, aluminium, copper and copper alloys.

No. in pack pcs	Part number	£ List Price excl. VAT
5	6 37 23 032 01 0	19.36



**Felt polishing pad**

Diameter 115 mm, with hook and loop fastening. Versatile in use, for polishing chrome, stainless steel, polycarbonate materials and gelcoat boat decks, for polishing up scratched paint and removing tempering colours on exhaust systems.

No. in pack pcs	Part number	£ List Price excl. VAT
5	6 37 23 036 01 0	21.46



**Sanding sheets, foam backing**

for removing scratches from paintwork, gelcoat, acrylic and polycarbonate glazing, lacquers, wood with a clear lacquer, furniture etc. For the best surface quality. 115 mm diameter with foam lamination, hook and loop fastening. Perfect as stage prior to polishing with felt polishing pad and FEIN EXTRA polish.

Grain	No. in pack pcs	Part number	£ List Price excl. VAT
500	5	6 37 17 246 01 0	14.81
1000	5	6 37 17 247 01 0	14.81



**Polishing liquid**

FEIN polish EXTRA based on aluminium oxide for polishing gelcoat and removing scratches in vehicle paint.

Contents ml	Part number	£ List Price excl. VAT
250	6 37 26 030 01 0	20.66

**General accessories**



**Table-top and drill jigs support**

Perfect for precision cut-outs: the power tool can be clamped to a table or workbench and the workpiece can be guided safely to the tool. It is also possible to clamp the tool in commercially available drill jigs with a 43 mm collar diameter – the tool can be delivered via the mechanism with millimetre precision. Suited to FEIN MULTIMASTER and FEIN SUPERCUT.

Part number	£ List Price excl. VAT
9 26 02 083 01 0	49.75



**Dust extraction set**

2 perforated sanding pads; perforated sanding sheets, 5 each of grit 60, 80, 120; 1 extractor hood with suction pipe; 1 adapter; 2 felt seals. For MULTIMASTER FMM 350 Q / QSL.

Part number	£ List Price excl. VAT
9 26 02 091 00 0	44.49



**Dust extraction set**

2 sanding pads, perforated; sanding sheets, perforated, 5 each of grit 60, 80, 120; 1 extractor hood with suction pipe; 2 hose sockets for hose connection with a diameter of 27 and 32 mm and 2 adapters for connecting to the most common household vacuum cleaners. FMM 250 / 250 Q, FMT 250 / 250Q, FMT 250 SL / 250 QSL

Part number	£ List Price excl. VAT
9 26 02 092 00 0	55.88



**Cutting paste**

Lubricating agents for working on sheet metals.

Part number	£ List Price excl. VAT
3 21 32 020 12 9	15.48



**Quick charger ALG 50**

For all FEIN Li-ion batteries. Charge time from 35 min.

Part number	£ List Price excl. VAT
9 26 04 129 01 0	45.53



**Quick charger ALG 30**

For FEIN NiCd and Li-ion batteries. Charge time from 25 min.

Part number	£ List Price excl. VAT
9 26 04 096 01 0	163.10



**Battery pack**

Li-ion battery with charge status indicator and FEIN SafetyCell technology. Protects the battery and tool from overload, overheating and total discharge. Can be used with all FEIN 12 V cordless tools and 18 V cordless tools with MultiVolt interface.

Current/Voltages V	Capacity Ah	Part number	£ List Price excl. VAT
12	2,5	9 26 04 168 02 0	31.90



**Battery pack**

Li-ion battery with charge status indicator and FEIN SafetyCell technology. Protects the battery and tool from overload, overheating and total discharge. Can be used with all FEIN 18 V cordless tools.

Current/Voltages V	Capacity Ah	Part number	£ List Price excl. VAT
18	5	9 26 04 173 02 0	111.38
18	2,5	9 26 04 171 02 0	76.34



**Work gloves**

Vibration-attenuating, certified according to EN 388/420, EN ISO 10819, EEC No. 0200, No. in pack 1 pair

Size	Part number	£ List Price excl. VAT
9 L	3 21 73 003 00 3	100.18
10 XL	3 21 73 004 00 1	100.18
11 XXL	3 21 73 005 00 5	100.18



**Adapter for FEIN oscillator (up to 2004)**

Spacer ring and clamping screw for older FEIN MULTIMASTER models MSx 636, MSx 636-1 and MSxe 636 II. Up to 40% improved torque transfer thanks to positive-fit connection to Starlock mounting on accessory side. Flat clamping screw for working flush with the surface.

Part number	£ List Price excl. VAT
3 52 22 927 05 0	10.65



**Additional handle**

For improved handling of the FSC 500 QSL during long periods of continuous use. Can also be used in conjunction with the extraction device 3 21 33 021 01 0.

Part number	£ List Price excl. VAT
3 21 19 148 02 0	44.28



**Device for dust extract**

For cutting and sawing applications with diamond-coated tools or E-CUT saw blades. Suitable for FEIN SUPERCUT FSC 500 QSL and AFSC 18 QSL.

Part number	£ List Price excl. VAT
3 21 33 021 01 0	67.55



**Dust extraction set**

2 sanding pads, perforated; sanding sheets, perforated, 5 each of grit 60, 80, 120; 1 extractor hood with suction pipe; 2 hose sockets for hose connection with a diameter of 27 and 32 mm and 2 adapters for connecting to the most common household vacuum cleaners.

FSC 500 QSL

Part number	£ List Price excl. VAT
9 26 02 095 00 0	53.04

**18 V battery**



**Battery pack**

Li-ion battery with charge status indicator and FEIN SafetyCell technology. Protects the battery and tool from overload, overheating and total discharge. Can be used with all FEIN 18 V cordless tools.

Current/Voltages V	Capacity Ah	Part number	£ List Price excl. VAT
18	5	9 26 04 173 02 0	111.38
18	2,5	9 26 04 171 02 0	76.34



**Battery starter set**

2 x Li-ion batteries with ALG 50 rapid charger.

Current/Voltages V	Capacity Ah	Part number	£ List Price excl. VAT
18	5	9 26 04 301 03 0	268.29
18	2,5	9 26 04 301 04 0	197.14

**12 V battery**



**Battery pack**

Li-ion battery with charge status indicator and FEIN SafetyCell technology. Protects the battery and tool from overload, overheating and total discharge. Can be used with all FEIN 12 V cordless tools and 18 V cordless tools with MultiVolt interface.

Current/Voltages V	Capacity Ah	Part number	£ List Price excl. VAT
12	2,5	9 26 04 168 02 0	31.90



**Battery starter set**

2 x Li-ion batteries with ALG 50 rapid charger.

Current/Voltages V	Capacity Ah	Part number	£ List Price excl. VAT
12	2,5	9 26 04 251 01 0	109.32

**Case**



**Carrying case unfilled**

Plastic case with practical inner layout, tool and accessories not included.  
FMM 250 / 250 Q, FMT 250 / 250Q, FMT 250 SL / 250 QSL

Part number	£ List Price excl. VAT
3 39 01 144 01 0	22.84



**Carrying case unfilled**

Plastic case with practical inner layout, tool and accessories not included.  
FMM 350 Q / QSL

Part number	£ List Price excl. VAT
3 39 01 131 98 0	49.50



**Systainer Sys 1**

Plastic, inner dimensions: H 75 x W 383 x D 273 mm

The tool-specific Systainer insert must be ordered separately.

Part number	£ List Price excl. VAT
3 39 01 146 00 0	54.22

**Systainer insert for FMM 350 Q / QSL**

Part number	£ List Price excl. VAT
3 39 04 491 00 0	10.55

**Accessory sets**



**Accessory set for interior construction work with wood**

27-part accessory set with extensive range of saw blades, especially for fast, precise sawing in all kinds of installation work. Identical to the scope of the professional set for interior work with wood. Attractive savings over purchasing the items individually. Contents: 5 E-CUT long-life saw blades (1 each of form 183, 160, 161, 201, 203), 2 E-CUT precision BIM saw blades (1 each of form 205, 208), 2 E-CUT universal saw blades (1 each of form 151, 152), 1 HSS bimetal saw blade for wood, diameter 100 mm, 1 depth stop, suitable for all saw blades, 1 triangular unperforated sanding pad, sanding sheets, 5 each of 80, 120, 180 grit.

Mount	Part number	£ List Price excl. VAT
SLM	3 52 22 946 01 0	170.79



**Accessory set for repairing/replacing windows**

23-part accessory set with extensive range of accessories, especially for removing old windows and replacing putty-mounted insulating glass. Identical to the scope of the professional set for window repair and replacement. Attractive savings over purchasing the items individually. Contents: 1 E-CUT long-life saw blade (form 203), 1 E-CUT universal saw blade (form 152), 1 HSS bimetal saw blade for wood, diameter 100 mm, 1 HSS bimetal saw blade for metal, diameter 100 mm, 1 depth stop, suitable for all saw blades, 1 mushroom-shaped cutter blade (form 245), 1 segment saw blade (form 244), 1 triangular unperforated sanding pad, sanding sheets, 5 each of 80, 120, 180 grit.

Mount	Part number	£ List Price excl. VAT
SLM	3 52 22 946 02 0	170.79



**Accessory set for tile restoration/bathroom renovation**

8-part accessory set with extensive range of accessories, especially for the perfect cutting-out of tiles and the removal of tile joints in bathroom renovation. Identical to the scope of the professional set for tile restoration / bathroom renovation. Attractive savings over purchasing the items individually. Contents: E-CUT universal saw blades (1 each of form 151, 152), 1 carbide saw blade, diameter 105 mm (form 214), 1 segmented diamond saw blade (form 243), 1 mushroom-shaped cutter blade (form 245), 1 long rigid stopper knife, triangular carbide rasps (1 each of 80 mm, 110 mm).

Mount	Part number	£ List Price excl. VAT
SLM	3 52 22 946 03 0	170.79



**Accessory set for heating/sanitary installation**

9-part accessory set with extensive range of accessories, especially for key applications in sanitary repairs. Identical to the scope of the professional set for heating / sanitary installation. Attractive savings over purchasing the items individually. Contents: E-CUT universal saw blades (1 each of form 151, 152), 1 segmented diamond saw blade (form 243), 1 cutter blade, 1 long rigid stopper knife, 1 triangular carbide rasp (110 mm), cutting tool (1 each of form 246, 247, 248), 1 cutter blade (form 239).

Mount	Part number	£ List Price excl. VAT
SLM	3 52 22 946 04 0	183.76



		<b>FEIN SUPERCUT FSC 2.0 Q</b>
		The powerful oscillator with quick clamping system for interior fitting and renovation.
<b>EAN 4014586...</b>		
<b>Page</b>		170
<b>Technical features</b>	Input	400 W
	Output	220 W
	Oscillations	11 000 - 18 500 1/min
	Amplitude	2 x 2,0°
	Tool Holder	Hexagon
	Tool change	QuickIN
	Cable with plug	5 m
Weight according to EPTA		1,45 kg



Type	Part number	PC	£ List Price excl. VAT
<b>FEIN SUPERCUT FSC 2.0 Q</b>	<b>7 236 36 50</b>	<b>03</b>	<b>617.00</b>
<b>Price includes:</b>			
1 Adapter Starlock, 1 plastic carrying case			
For accessories, see page 171			

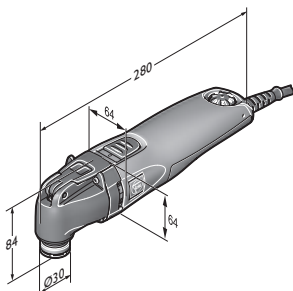

FEIN SUPERCUT FSC 2.0 Q



**Sawing**



**Saw blades**

HSS, with fine teeth for precise cutting. Universal use on sheet metal of up to approx. 1 mm, can be doubled in plastics.

Ø mm	No. in pack pcs	Part number	£ List Price excl. VAT
63	2	6 35 02 102 01 6	46.31
63	5	6 35 02 102 07 0	92.56
80	2	6 35 02 103 01 0	48.22
80	5	6 35 02 103 05 0	96.33



**Saw blades**

HSS, cranked, countersunk clamping screw for flush working.

Ø mm	No. in pack pcs	Part number	£ List Price excl. VAT
85	1	6 35 02 177 01 0	47.41
85	5	6 35 02 177 05 0	189.70
100	1	6 35 02 178 01 0	49.38
100	5	6 35 02 178 05 0	197.46



**Segment saw blade**

HSS, cranked, countersunk clamping screw for flush working.

Ø mm	No. in pack pcs	Part number	£ List Price excl. VAT
100	1	6 35 02 196 01 0	45.92
100	5	6 35 02 196 05 0	206.63



**Best of E-Cut accessory set XXL**

Includes 10 different E-Cut saw blades at a special price. Contents: 2 x E-Cut Long-Life 32 mm wide (shape 162), 3 x E-Cut Long-Life 42 mm wide (shape 163), 3 x E-Cut Long-Life 35 mm wide (shape 164), 2 x E-Cut Long-Life 65 mm wide (shape 165) in a practical plastic storage box.

Part number	£ List Price excl. VAT
6 35 02 162 15 0	105.52



**Best of E-Cut accessory set**

Includes 6 different E-Cut saw blades. Content: E-Cut Universal (1x 28 mm and 1x 44 mm wide), 2x E-Cut Long-Life 35 mm wide, 2x E-Cut Long-Life 65 mm wide, in practical plastic storage box.

Part number	£ List Price excl. VAT
6 35 02 147 12 0	74.45



**E-Cut long-life saw blades**

Bi-metallic teeth, stepped, high cutting speed. Extremely durable and robust. For hardwood, softwood and all other wooden materials - including those with nails. Also perfectly suited to plastics and plasterboard. Length 78 mm, form 162

Width mm	No. in pack pcs	Part number	£ List Price excl. VAT
32	1	6 35 02 162 01 0	16.17
32	5	6 35 02 162 02 0	67.29
32	25	6 35 02 162 03 0	294.29



**E-Cut long-life saw blades**

Bi-metallic teeth, stepped, high cutting speed. Extremely durable and robust. For hardwood, softwood and all other wooden materials - including those with nails. Also perfectly suited to plastics and plasterboard. Length 78 mm, form 163

Width mm	No. in pack pcs	Part number	£ List Price excl. VAT
42	1	6 35 02 163 01 0	16.80
42	5	6 35 02 163 02 0	69.88
42	25	6 35 02 163 03 0	305.61



**E-Cut long-life saw blades**

Bi-metallic teeth, stepped, high cutting speed. Extremely durable and robust. For hardwood, softwood and all other wooden materials - including those with nails. Also perfectly suited to plastics and plasterboard. Length 50 mm, form 164

Width mm	No. in pack pcs	Part number	£ List Price excl. VAT
35	1	6 35 02 164 01 0	17.23
35	5	6 35 02 164 02 0	71.56
35	25	6 35 02 164 03 0	313.23



**E-Cut long-life saw blades**

Bi-metallic teeth, stepped, high cutting speed. Extremely durable and robust. For hardwood, softwood and all other wooden materials - including those with nails. Also perfectly suited to plastics and plasterboard. Length 50 mm, form 165

Width mm	No. in pack pcs	Part number	£ List Price excl. VAT
65	1	6 35 02 165 01 0	18.68
65	5	6 35 02 165 02 0	77.63
65	25	6 35 02 165 03 0	339.75



**E-Cut long-life saw blades**

Bi-metallic teeth, stepped, high cutting speed. Extremely durable and robust. For hardwood, softwood and all other wooden materials - including those with nails. Also perfectly suited to plastics and plasterboard. Length 30 mm, form 186

Width mm	No. in pack pcs	Part number	£ List Price excl. VAT
10	1	6 35 02 186 01 0	10.15
10	5	6 35 02 186 02 0	42.24
10	25	6 35 02 186 03 0	184.69



**E-Cut long-life saw blades**

Bi-metallic teeth, stepped, high cutting speed. Extremely durable and robust. For hardwood, softwood and all other wooden materials - including those with nails. Also perfectly suited to plastics and plasterboard. Length 34 mm, form 185

Width mm	No. in pack pcs	Part number	£ List Price excl. VAT
20	1	6 35 02 185 01 0	13.13
20	5	6 35 02 185 02 0	54.68
20	25	6 35 02 185 03 0	239.25



**E-Cut standard saw blades**

Crossed toothing for all wood, plasterboard, and plastics jobs. Length 78 mm, form 123

Width mm	No. in pack pcs	Part number	£ List Price excl. VAT
32	1	6 35 02 123 01 8	14.68
32	5	6 35 02 123 04 6	61.16
32	25	6 35 02 123 03 0	267.54



**E-Cut standard saw blades**

Crossed toothing for all wood, plasterboard, and plastics jobs. Length 78 mm, form 124

Width mm	No. in pack pcs	Part number	£ List Price excl. VAT
42	1	6 35 02 124 01 6	15.30
42	5	6 35 02 124 04 4	63.56
42	25	6 35 02 124 03 8	277.97



**E-Cut standard saw blades**

Crossed tothing for all wood, plasterboard, and plastics jobs.  
Length 50 mm, form 135

Width mm	No. in pack pcs	Part number	£ List Price excl. VAT
35	1	6 35 02 135 01 9	16.00
35	25	6 35 02 135 02 5	291.24
35	5	6 35 02 135 03 1	66.57



**E-Cut standard saw blades**

Crossed tothing for all wood, plasterboard, and plastics jobs.  
Length 50 mm, form 136

Width mm	No. in pack pcs	Part number	£ List Price excl. VAT
65	1	6 35 02 136 01 2	17.34
65	25	6 35 02 136 02 8	315.39
65	5	6 35 02 136 03 4	72.08



**E-Cut precision saw blades**

Double-row original Japan tothing, for top-precision cuts, and clean cutting edges even freely by hand  
Length 50 mm, form 119

Width mm	No. in pack pcs	Part number	£ List Price excl. VAT
35	1	6 35 02 119 01 0	20.59
35	5	6 35 02 119 04 8	85.72
35	25	6 35 02 119 03 2	375.00



**E-Cut precision saw blades**

Double-row original Japan tothing, for top-precision cuts, and clean cutting edges even freely by hand  
Length 50 mm, form 120

Width mm	No. in pack pcs	Part number	£ List Price excl. VAT
45	1	6 35 02 120 01 2	21.18
45	25	6 35 02 120 03 4	385.02
45	5	6 35 02 120 04 0	88.02



**E-Cut precision saw blades**

Double-row original Japan tothing, for top-precision cuts, and clean cutting edges even freely by hand  
Length 50 mm, form 121

Width mm	No. in pack pcs	Part number	£ List Price excl. VAT
55	1	6 35 02 121 01 1	21.72
55	25	6 35 02 121 03 3	395.45
55	5	6 35 02 121 04 9	90.39



**E-Cut precision saw blades**

Double-row original Japan tothing, for top-precision cuts, and clean cutting edges even freely by hand  
Length 50 mm, form 122

Width mm	No. in pack pcs	Part number	£ List Price excl. VAT
65	1	6 35 02 122 01 4	22.27
65	5	6 35 02 122 04 2	92.65
65	25	6 35 02 122 03 6	405.23



**E-Cut precision BIM saw blade**

Bimetal with double-row Japan teeth for all wooden materials, plasterboard and soft plastics. Improved tool life and robustness. The fastest cutting speed and maximum precision.  
Length 50 mm, form 209

Width mm	No. in pack pcs	Part number	£ List Price excl. VAT
35	1	6 35 02 209 01 0	16.38
35	5	6 35 02 209 02 0	73.69
35	25	6 35 02 209 03 0	327.48



**E-Cut precision BIM saw blade**

Bimetal with double-row Japan teeth for all wooden materials, plasterboard and soft plastics. Improved tool life and robustness. The fastest cutting speed and maximum precision.  
Length 50 mm, form 210

Width mm	No. in pack pcs	Part number	£ List Price excl. VAT
45	1	6 35 02 210 01 0	16.84
45	5	6 35 02 210 02 0	75.66
45	25	6 35 02 210 03 0	336.35



**E-Cut precision BIM saw blade**

Bimetal with double-row Japan teeth for all wooden materials, plasterboard and soft plastics. Improved tool life and robustness. The fastest cutting speed and maximum precision.  
Length 50 mm, form 211

Width mm	No. in pack pcs	Part number	£ List Price excl. VAT
55	1	6 35 02 211 01 0	17.25
55	5	6 35 02 211 02 0	77.66
55	25	6 35 02 211 03 0	345.20



**E-Cut precision BIM saw blade**

Bimetal with double-row Japan teeth for all wooden materials, plasterboard and soft plastics. Improved tool life and robustness. The fastest cutting speed and maximum precision.  
Length 50 mm, form 212

Width mm	No. in pack pcs	Part number	£ List Price excl. VAT
65	1	6 35 02 212 01 0	17.72
65	5	6 35 02 212 02 0	79.64
65	25	6 35 02 212 03 0	354.02



**E-Cut universal saw blades**

Bi-metal teeth, cranked, also suitable for radii, high speed cut, sheet metal (400 N/mm<sup>2</sup>) up to about 2 mm and plastics, aluminium profiles, copper pipes, wood, plasterboard, and almost all plastics.  
Length 60 mm, form 147

Width mm	No. in pack pcs	Part number	£ List Price excl. VAT
28	1	6 35 02 147 01 5	20.39
28	5	6 35 02 147 02 1	84.82
28	25	6 35 02 147 03 7	371.08



**E-Cut universal saw blades**

Bi-metal teeth, cranked, also suitable for radii, high speed cut, sheet metal (400 N/mm<sup>2</sup>) up to about 2 mm and plastics, aluminium profiles, copper pipes, wood, plasterboard, and almost all plastics.  
Length 60 mm, form 148

Width mm	No. in pack pcs	Part number	£ List Price excl. VAT
44	1	6 35 02 148 01 3	20.97
44	5	6 35 02 148 02 9	87.14
44	25	6 35 02 148 03 5	381.33



**HSS saw blade wood**

Ideal for long, straight cuts and for cutting out laid parquet or laminate flooring.  
Without depth stop

Width mm	No. in pack pcs	Part number	£ List Price excl. VAT
100	1	6 35 02 179 01 0	70.28



**HSS saw blade wood**

Ideal for long, straight cuts and for cutting out laid parquet or laminate flooring.  
With depth stop

Width mm	No. in pack pcs	Part number	£ List Price excl. VAT
100	1	6 35 02 179 02 0	72.43



**Depth stop**

Depth stop for all saw blades. For accurate working at depth. Effective protection for blade and workpiece. Contents: 1 adapter for attachment to the machine, rotates freely through 360°. 1 depth stop, 1 depth-adjustable guide block. Can only be used with (A)FMM or (A)FSC.

Part number	£ List Price excl. VAT
3 21 27 069 01 0	20.15



**M-Cut Saw Blade**

For cuts, cut-outs, and grooves in sheet metal, plastics, fibreglass, and carbon fibre-reinforced plastic; 2-pack. Wide

Width mm	Length mm	Part number	£ List Price excl. VAT
30	50	6 35 02 138 01 4	16.94



**M-Cut Saw Blade**

For cuts, cut-outs, and grooves in sheet metal, plastics, fibreglass, and carbon fibre-reinforced plastic; 2-pack. Narrow

Width mm	Length mm	Part number	£ List Price excl. VAT
10	50	6 35 02 158 01 0	18.04



**Carbide saw blade with open teeth**

For perfect, clean cut edges in carbon fibre-reinforced plastic/fibreglass-reinforced plastic materials without delamination. Distortion-free, long, straight cuts at high cutting speed. Can also be used with depth stop.

Width mm	Length mm	Part number	£ List Price excl. VAT
1,2	105	6 35 02 189 01 0	48.46



**E-Cut carbide saw blade**

Gentle sawing with perfect, clean cut edges in carbon fibre-reinforced plastic/fibreglass-reinforced plastic materials without delamination. Particularly well suited to precise cut-outs and short cuts. Precise working into the corners and on edges. Can also be used with depth stop.

Width mm	Length mm	Part number	£ List Price excl. VAT
35	50	6 35 02 192 01 0	29.02



**Diamond segment saw blade with open teeth**

For perfect, clean cut edges in carbon fibre-reinforced plastic/fibreglass-reinforced plastic materials without delamination. Distortion-free, long, straight cuts at very high cutting speed. Diamond coating for outstanding service life. Can also be used with depth stop.

Ø mm	Cutting width mm	Part number	£ List Price excl. VAT
105	1,2	6 35 02 190 01 0	116.84



**E-Cut diamond saw blade**

Gentle sawing with perfect, clean cut edges in carbon fibre-reinforced plastic/fibreglass-reinforced plastic materials without delamination. Particularly well suited to precise cut-outs and short cuts. Diamond coating for outstanding service life. Precise working into the corners and on edges. Can also be used with depth stop.

Width mm	Length mm	Part number	£ List Price excl. VAT
35	50	6 35 02 194 01 0	47.15



**E-Cut diamond saw blade**

Gentle sawing with perfect, clean cut edges in carbon fibre-reinforced plastic/fibreglass-reinforced plastic materials without delamination. Particularly well suited to precise cut-outs and short cuts. Diamond coating for outstanding service life. Precise working into the corners and on edges. Can also be used with depth stop.

Width mm	Length mm	Part number	£ List Price excl. VAT
42	60	6 35 02 195 01 0	53.46



**Carbide file**

For deburring and filing cut-outs in fibreglass, CFRP, plastics and wood, length 50 mm

No. in pack pcs	Part number	£ List Price excl. VAT
2	6 37 06 018 01 0	24.23



**Segment saw blade**

depressed, for removing panes of insulating glass installed on a putty bed, pack of 2

Part number	£ List Price excl. VAT
6 39 03 166 01 6	68.54

**Rasping**



**Carbide rasp, triangular**

For rough sanding of filler, tile adhesives, concrete, stone and wood. For use with or without dust extractor. Large version for particularly good work progress and efficient machining of several square metres, edge length 110 mm.

Part number	£ List Price excl. VAT
6 37 31 005 01 0	28.82

**Remove grouts**

**Carbide saw blade**

In comparison with the diamond version, the price is lower and the service life shorter. Stepped, cutting line approx. 2.2 mm, standard for all marble, epoxy resin and concrete trass joints.

Ø mm	No. in pack pcs	Part number	£ List Price excl. VAT
105	1	6 35 02 172 01 0	43.52
105	5	6 35 02 172 02 0	174.00



**Carbide saw blade**

In comparison with the diamond version, the price is lower and the service life shorter. Extra thin version, cutting line approx. 1.2 mm, not suited to very hard epoxy resin or cement joints. Also suited to reworking deck joints.

Ø mm	No. in pack pcs	Part number	£ List Price excl. VAT
105	1	6 35 02 173 01 0	43.52
105	5	6 35 02 173 02 0	174.00



**Carbide segment blade**

In comparison with the diamond version, the price is lower and the service life shorter. For corners and radii and for working without overcutting, cutting line approx. 2.2 mm for all marble and epoxy resin joints.

No. in pack pcs	Part number	£ List Price excl. VAT
1	6 39 03 225 01 0	43.52
5	6 39 03 225 02 0	174.00



**Carbide segment blade**

In comparison with the diamond version, the price is lower and the service life shorter. For corners and radii and for working without overcutting, extra thin version, cutting line approx. 1.2 mm, cutting depth max. 10 mm. Not suited to very hard epoxy resin or cement joints.

No. in pack pcs	Part number	£ List Price excl. VAT
1	6 39 03 224 01 0	43.52
5	6 39 03 224 02 0	174.00



**Diamond-coated saw blade**

Cutting line approx. 2.2 mm, standard design for all marble, epoxy resins and cement trass mortar.

Ø mm	No. in pack pcs	Part number	£ List Price excl. VAT
80	1	6 35 02 115 01 1	110.65
80	5	6 35 02 115 03 0	446.96
105	1	6 35 02 167 01 0	111.75
105	5	6 35 02 167 02 0	446.97

Oscillating  
multi-tool



**Diamond-coated saw blade**

Cutting line approx. 1.2 mm for extremely thin marble mortar joints. Not suitable for epoxy resin and cement trass mortar.

Ø mm	No. in pack pcs	Part number	£ List Price excl. VAT
80	1	6 35 02 116 01 4	110.65
80	5	6 35 02 116 02 0	446.96
105	1	6 35 02 168 01 0	111.75
105	5	6 35 02 168 02 0	446.97



**Segment blade**

Diamond-coated, also for corners and radii and for working without overcutting. Cutting line approx. 2.2 mm, standard design for all marble, epoxy resins and cement trass mortar.

No. in pack pcs	Part number	£ List Price excl. VAT
1	6 39 03 162 01 7	80.79
5	6 39 03 162 03 0	323.18



**Segment blade**

Diamond-coated, also for corners and radii and for working without overcutting. Cutting line approx. 1,2 mm, for extremely narrow marble joints. Cutting depth max. 10 mm. Not suitable for epoxy resin or trass cement joints.

No. in pack pcs	Part number	£ List Price excl. VAT
1	6 39 03 196 01 3	80.79
5	6 39 03 196 02 0	323.18



**Cleaning block**

Rhombus for cleaning the carbide tools and diamond-coated tools.

Part number	£ List Price excl. VAT
6 37 19 007 01 0	22.68



**Cutting blade**

Straight shape. Universal blade for almost all expansion sealants. Pack of 5

Part number	£ List Price excl. VAT
6 39 03 117 01 5	23.10



**Cutting blade**

Straight, long, for very deep joints, pack of 5

Part number	£ List Price excl. VAT
6 39 03 116 01 1	74.14



**Segment blade**

Segment form for V-cut from outside and for cuts in corners, 2-pack

Total length mm	Cut length mm	Part number	£ List Price excl. VAT
73	30	6 39 03 132 01 0	51.85

**Scraping**



**Scraper blade**

for removing floor covering remains, underseal and residual bonding material, etc., pack of 2

Length mm	No. in pack pcs	Part number	£ List Price excl. VAT
64	2	6 39 03 206 01 8	21.91
72	2	6 39 03 227 01 0	22.24

**Cutting**



**Cutting blade**

Mushroom-shaped, pack of 5, For cutting elastic silicon or acrylic connecting joints.

Part number	£ List Price excl. VAT
6 39 03 128 01 2	16.79



**Cutting tool**

For making grooves in rigid foam panels for electrical, wall and underfloor heating.

Cutting depth mm	Width mm	Cutting width mm	Part number	£ List Price excl. VAT
6,5	50	13	6 39 03 223 01 0	36.23



**Cutting tool**

For making grooves in rigid foam panels for electric cables.

Width mm	Immersion Ø mm	Part number	£ List Price excl. VAT
50	12	6 39 03 222 01 0	36.23



**Cutting tool**

For making grooves in rigid foam panels for 1/2" and 3/4" hot water pipes and for empty pipes for electrical installation. Automatic fixing of laid pipes. Simple, quick and safe to use.

Width mm	Immersion Ø mm	Part number	£ List Price excl. VAT
50	22	6 39 03 221 01 0	36.23



**Cutting tool**

Blade for 90° cut-out for bending Schlüter Kerdi-Boards®.

Cutting depth mm	Part number	£ List Price excl. VAT
12,5	6 39 03 231 01 0	15.24
12,5	6 39 03 230 01 0	15.24
28	6 39 03 229 01 0	15.21
38	6 39 03 228 01 0	15.21





**General accessories**

**Systemer insert for AFSC 18 Q**

Part number	£ List Price excl. VAT
3 39 04 542 00 0	8.70



**Device for dust extract**

FSC 2.0 Q  
For jobs with diamond-coated tools; tool-free mount. Hose connection Ø 32 mm.

Part number	£ List Price excl. VAT
9 26 02 084 01 0	71.70



**Device for dust extract**

FSC 2.0 X  
For jobs with diamond-coated tools; tool-free mount. Hose connection Ø 32 mm.

Part number	£ List Price excl. VAT
9 26 02 075 01 8	70.41



**Dust extraction set**

For all sanding and rasping jobs with triangular sanding pad and carbide rasp. incl. 2 sanding pads, perforated; 5 of each type of sanding sheet, perforated, grit 60, 80, and 120; 1 extractor hood with suction tube; 2 hose nozzles for hose connection Ø 27 and 32 mm plus 2 adapters for connection to the most common domestic vacuum cleaners. For FSC 2.0 Q.

Part number	£ List Price excl. VAT
9 26 02 074 01 4	55.09



**Work gloves**

Vibration-attenuating, certified according to EN 388/420, EN ISO 10819, EEC No. 0200, No. in pack 1 pair

Size	Part number	£ List Price excl. VAT
9 L	3 21 73 003 00 3	100.18
10 XL	3 21 73 004 00 1	100.18
11 XXL	3 21 73 005 00 5	100.18



**Bail handle**

To reduce the vibrations and for better handling of the FEIN SUPERCUT during longer jobs. Can be used in connection with the dust extraction device 9 26 02 084 01 0.

Part number	£ List Price excl. VAT
3 21 19 116 01 1	46.85



**Adapter for FEIN SUPERCUT without QuickIN**

Needed to hold accessories with an 8-star holder (e.g. rasps, sanding and polishing pads).

Part number	£ List Price excl. VAT
3 06 05 114 01 1	25.37



**Adapter for FEIN SUPERCUT without QuickIN**

to mount Starlock accessories on older FEIN SUPERCUT units without QuickIN tool mounting (FSC 1.6, FSC 1.7). Adapter plus clamping screw.

Part number	£ List Price excl. VAT
3 52 22 952 04 0	13.90



**Adapter for FEIN SUPERCUT with QuickIN**

Needed to hold accessories with an 8-star holder (e.g. rasps, sanding and polishing pads).

Part number	£ List Price excl. VAT
6 37 33 005 01 0	24.03



**Adapter for FEIN SUPERCUT with QuickIN**

to mount Starlock accessories on older FEIN SUPERCUT units with QuickIN tool mounting (FSC 1.6 Q, FSC 1.7 Q, FSC 2.0 Q, AFSC 1.7 Q and AFSC 18). Adapter plus clamping screw.

Part number	£ List Price excl. VAT
3 52 22 952 05 0	13.90



**Cutting paste**

Lubricating agents for working on sheet metals.

Part number	£ List Price excl. VAT
3 21 32 020 12 9	15.48

**Accessory sets**



**Accessory set for interior construction work with wood**

Additional purchase for professional set for interior construction work with wood, consisting of: 1 HSS saw blade for wood (form 153); 4 E-CUT long-life saw blades (form 162, 163 and 164, 165); 4 E-CUT precision saw blades (form 119, 120 and 121, 122); 2 E-CUT universal saw blades (form 147, 148); 1 depth stop; 1 sanding pad; 5 each of sanding sheets, grain 80, 120, 180; 1 adapter and 2 tensioning elements

Part number	£ List Price excl. VAT
6 39 03 167 66 0	185.17



**Accessory set for repairing/replacing windows**

Additional purchase for professional set for repairing/replacing windows, consisting of: 1 HSS saw blade, stepped (form 137); 1 HSS saw blade for wood (form 153); 1 E-CUT long-life saw blade (form 163); 2 E-CUT universal saw blades (form 147, 148); 1 segment saw blade (form 166); 1 cutter blade, mushroom-shaped (form 128); 1 depth stop; 1 sanding pad; 5 each of sanding sheets, grain 80, 120, 180; 1 adapter and 2 tensioning elements

Part number	£ List Price excl. VAT
6 39 03 167 67 0	185.17



**Accessory set for tile restoration/bathroom renovation**

Additional purchase for professional set for tile restoration/bathroom renovation, consisting of: 1 segment blade, diamond-coated (form 162); 1 carbide segment blade (thin) (form 224); 1 blade, mushroom-shaped (form 128); 1 stopper knife; 2 carbide-coated rasps; 2 E-CUT universal saw blades (form 147, 148); 1 adapter and 1 tensioning element.

Part number	£ List Price excl. VAT
6 39 03 167 58 0	185.17



**Accessory set for heating/sanitary installation**

Additional purchase for professional set for heating/sanitary installation, consisting of: 1 diamond-coated segment blade (form 162); 3 cut-out blades (12 mm, 13 mm, 22 mm); 1 cutter blade, straight (form 116); 2 E-CUT universal saw blades (form 147, 148); 1 stopper knife; 1 carbide-coated rasp; 1 adapter and 2 tensioning elements

Part number	£ List Price excl. VAT
6 39 03 167 59 0	185.17



	FEIN cordless SUPERCUT AFSC 1.7 Q	FEIN cordless SUPERCUT AFSC 1.7 QC	FEIN cordless SUPERCUT AFSC 1.7 Q Auto Glass	FEIN SUPERCUT FSC 1.6	FEIN SUPERCUT FSC 1.6 Q Auto Glass	FEIN SUPERCUT MOtx 6-25	
	The high-performance battery-powered oscillator with quick clamping system for the automotive industry.		The powerful system for vehicle repairs with special accessories for quick and safe removal of vehicle windows.	The powerful oscillator for the vehicle industry.	The powerful system for vehicle repairs with special accessories for quick and safe removal of vehicle windows.	The powerful pneumatic oscillator for cargo.	
<b>EAN 4014586...</b>	... 885209	... 885186	... 884004		... 862859	... 861906	
<b>Page</b>	177	177	177	177	177	177	
<b>Technical features</b>	Input			400 W	400 W		
	Output			220 W	220 W		
	Battery voltage	18 V	18 V	18 V			
	Battery capacity	5 Ah	2,5 Ah	5 Ah			
	Battery compatibility	Li-ion/HighPower Li-ion	Li-ion/HighPower Li-ion	Li-ion/HighPower Li-ion			
	Battery interface	MultiVolt	MultiVolt	MultiVolt			
	Oscillations	10 000 - 19 500 1/min	10 000 - 19 500 1/min	10 000 - 19 500 1/min	11 000 - 18 500 1/min	11 000 - 18 500 1/min	20 000 1/min
	Tool Holder	Hexagon	Hexagon	Hexagon	Hexagon	Hexagon	
	Tool change	QuickIN	QuickIN	QuickIN	Manual with screw, hexagon socket	QuickIN	
	Operating pressure						6,3 bar
	Air consumption						0,6 m³/min
	Cable with plug				5 m	5 m	
	Weight according to EPTA				1,25 kg	1,45 kg	0,90 kg
	Weight with battery	1,80 kg	1,60 kg	1,80 kg			
Weight without storage battery	0,90 kg	0,90 kg	0,90 kg				



Type	Part number	EAN	PC	£ List Price excl. VAT
<b>FEIN cordless SUPERCUT AFSC 1.7 Q</b>	<b>7 129 18 63 00 0</b>	<b>4014586885209</b>	<b>03</b>	<b>600.00</b>

**Price includes:**  
2 battery packs (Li-ion), 1 battery charger, 1 protective cover for tool changes, 1 sharpening stone (6 37 19 010 01 4), 1 plastic carrying case  
For accessories, see page 178



Type	Part number	EAN	PC	£ List Price excl. VAT
<b>FEIN cordless SUPERCUT AFSC 1.7 QC</b>	<b>7 129 18 62 00 0</b>	<b>4014586885186</b>	<b>03</b>	<b>509.00</b>

**Price includes:**  
2 battery packs (Li-ion), 1 battery charger, 1 protective cover for tool changes, 1 sharpening stone (6 37 19 010 01 4), 1 plastic carrying case  
For accessories, see page 178



Type	Part number	EAN	PC	£ List Price excl. VAT
<b>FEIN cordless SUPERCUT AFSC 1.7 Q Auto Glass</b>	<b>7 129 18 61 00 0</b>	<b>4014586884004</b>	<b>03</b>	<b>737.00</b>

**Price includes:**  
2 battery packs (Li-ion), 1 battery charger, 1 protective cover for tool changes, 1 Straight cutter blade, Z-bend, toothed (form 081), 1 each U-shaped cutter blade, reinforced design (forms 157 and 111), 1 L-shaped cutter blade, toothed (form 209), 2 L-shaped cutter blades, toothed (form 208), 2 U-shaped cutter blades, reinforced design, toothed (form 212), 3 L-shaped cutter blades, toothed (form 207), 1 Straight cutter blade, Z-bend, with adjustable roller stop (form 143), 1 sharpening stone (6 37 19 010 01 4), 1 plastic carrying case  
For accessories, see page 178



Type	Part number	PC	£ List Price excl. VAT
<b>FEIN SUPERCUT FSC 1.6</b>	<b>7 236 31 50</b>	<b>03</b>	<b>645.00</b>

**Price includes:**  
1 Mounting bolt (3 30 01 039 01 7), 1 key, 1 plastic carrying case, 1 sharpening stone (6 37 19 010 01 4)  
For accessories, see page 178



Type	Part number	EAN	PC	£ List Price excl. VAT
<b>FEIN SUPERCUT FSC 1.6 Q Auto Glass</b>	<b>7 236 42 56 01 0</b>	<b>4014586862859</b>	<b>03</b>	<b>694.00</b>

**Price includes:**  
1 L-shaped cutter blade, toothed (form 209), 1 Straight cutter blade, Z-bend, toothed (form 081), 1 Straight cutter blade, Z-bend, with adjustable roller stop (form 143), 2 U-shaped cutter blades, reinforced design, toothed (form 212), 3 L-shaped cutter blades, toothed (form 207), 2 L-shaped cutter blades, toothed (form 208), 1 each U-shaped cutter blade, reinforced design (forms 157 and 111), 1 protective cover for tool changes, 1 sharpening stone (6 37 19 010 01 4), 1 plastic carrying case  
For accessories, see page 178



Type	Part number	EAN	PC	£ List Price excl. VAT
<b>FEIN SUPERCUT MOTlx 6-25</b>	<b>7 536 03 00 01 0</b>	<b>4014586861906</b>	<b>03</b>	<b>787.00</b>

**Price includes:**  
2 keys, 1 plastic carrying case  
For accessories, see page 178

Oscillating multi-tool

**General accessories**



**Protective cover**  
For safe tool changes for SUPERCUT with QuickIN when opening and closing the clamping lever.

Part number	£ List Price excl. VAT
3 21 74 011 00 0	6.81



**Sharpening stone**  
For sharpening blades before use to produce an optimum cut.

Part number	£ List Price excl. VAT
6 37 19 010 01 4	11.68



**Cutting paste**  
Lubricating agents for working on sheet metals.

Part number	£ List Price excl. VAT
3 21 32 020 12 9	15.48



**Work gloves**  
Vibration-attenuating, certified according to EN 388/420, EN ISO 10819, EEC No. 0200, No. in pack 1 pair

Size	Part number	£ List Price excl. VAT
9 L	3 21 73 003 00 3	100.18
10 XL	3 21 73 004 00 1	100.18
11 XXL	3 21 73 005 00 5	100.18



**Adapter for FEIN SUPERCUT without QuickIN**  
Needed to hold accessories with an 8-star holder (e.g. rasps, sanding and polishing pads).

Part number	£ List Price excl. VAT
3 06 05 114 01 1	25.37



**Adapter for FEIN SUPERCUT with QuickIN**  
Needed to hold accessories with an 8-star holder (e.g. rasps, sanding and polishing pads).

Part number	£ List Price excl. VAT
6 37 33 005 01 0	24.03



**Adapter for FEIN SUPERCUT with QuickIN**  
to mount Starlock accessories on older FEIN SUPERCUT units with QuickIN tool mounting (FSC 1.6 Q, FSC 1.7 Q, FSC 2.0 Q, AFSC 1.7 Q and AFSC 18). Adapter plus clamping screw.

Part number	£ List Price excl. VAT
3 52 22 952 05 0	13.90



**Adapter for FEIN SUPERCUT without QuickIN**  
to mount Starlock accessories on older FEIN SUPERCUT units without QuickIN tool mounting (FSC 1.6, FSC 1.7). Adapter plus clamping screw.

Part number	£ List Price excl. VAT
3 52 22 952 04 0	13.90

**Automotive workshop accessories**



**Straight form**  
curved, Z-bend, as subsequent order for removal device  
9 06 07 001 01 6, 2-pack.

Part number	£ List Price excl. VAT
6 39 03 197 01 7	88.62



**Saw blades**  
HSS, with fine teeth for precise cutting. Universal use on sheet metal of up to approx. 1 mm, can be doubled in plastics.

Ø mm	No. in pack pcs	Part number	£ List Price excl. VAT
63	2	6 35 02 102 01 6	46.31
63	5	6 35 02 102 07 0	92.56
80	2	6 35 02 103 01 0	48.22
80	5	6 35 02 103 05 0	96.33



**M-Cut Saw Blade**  
For cuts, cut-outs, and grooves in sheet metal, plastics, fibreglass, and carbon fibre-reinforced plastic; 2-pack.  
Wide

Width mm	Length mm	Part number	£ List Price excl. VAT
30	50	6 35 02 138 01 4	16.94



**M-Cut Saw Blade**  
For cuts, cut-outs, and grooves in sheet metal, plastics, fibreglass, and carbon fibre-reinforced plastic; 2-pack.  
Narrow

Width mm	Length mm	Part number	£ List Price excl. VAT
10	50	6 35 02 158 01 0	18.04



**Carbide file**  
For deburring and filing cut-outs in fibreglass, CFRP, plastics and wood, length 50 mm

No. in pack pcs	Part number	£ List Price excl. VAT
2	6 37 06 018 01 0	24.23



**E-Cut universal saw blades**  
Bi-metal teeth, cranked, also suitable for radii, high speed cut, sheet metal (400 N/mm<sup>2</sup>) up to about 2 mm and plastics, aluminium profiles, copper pipes, wood, plasterboard, and almost all plastics.  
Length 60 mm, form 147

Width mm	No. in pack pcs	Part number	£ List Price excl. VAT
28	1	6 35 02 147 01 5	20.39
28	5	6 35 02 147 02 1	84.82



**E-Cut universal saw blades**  
Bi-metal teeth, cranked, also suitable for radii, high speed cut, sheet metal (400 N/mm<sup>2</sup>) up to about 2 mm and plastics, aluminium profiles, copper pipes, wood, plasterboard, and almost all plastics.  
Length 60 mm, form 148

Width mm	No. in pack pcs	Part number	£ List Price excl. VAT
44	1	6 35 02 148 01 3	20.97
44	5	6 35 02 148 02 9	87.14



**Straight form**  
suitable for round grooves in plastics.  
toothed, 2-pack.

Total length mm	Cut length mm	Part number	£ List Price excl. VAT
56	35	6 39 03 073 01 1	53.23



**Straight form**  
Suitable for removal of chassis attachment parts.  
Z-bend, toothed, 2-pack.

Total length mm	Cut length mm	Part number	£ List Price excl. VAT
120	60	6 39 03 081 01 3	75.21



**Scraper blade**  
for removing floor covering remains, underseal and residual bonding material, etc., pack of 2

Length mm	No. in pack pcs	Part number	£ List Price excl. VAT
64	2	6 39 03 206 01 8	21.91
72	2	6 39 03 227 01 0	22.24



**Cutting blade**  
Mushroom-shaped, pack of 5, For cutting elastic silicon or acrylic connecting joints.

Part number	£ List Price excl. VAT
6 39 03 128 01 2	16.79

**FEIN accessories for removing residual bonding beads**



**Scraper knife**  
Spade-shaped, with scratch-protective coating, 2-pack.

Total length mm	Cut length mm	Part number	£ List Price excl. VAT
64	12	6 39 03 129 05 0	68.21
65	18	6 39 03 146 01 8	69.16
64	25	6 39 03 105 01 9	69.42



**Scraper knife**  
with cross cutter and scratch protective coating on front limit stop, 2-pack.

Cutting width mm	Part number	£ List Price excl. VAT
13	6 39 03 113 01 6	69.42
25	6 39 03 131 01 7	68.21



**Scraper knife**  
with cross cutter, 2-pack.

Cutting width mm	Part number	£ List Price excl. VAT
13	6 39 03 144 01 1	67.94



**Scraper knife set**  
consisting of: 1 each of spade-shaped scraper knife, with scratch-protective coating (forms 129/105).

Part number	£ List Price excl. VAT
6 39 03 129 01 6	68.21



**Scraper knife set**  
consisting of: 1 each of scraper knife with cross cutter and scratch protective coating on front limit stop (form 113/131).

Part number	£ List Price excl. VAT
6 39 03 113 02 2	69.42

**Vehicle glazing accessories**



**U-shaped**  
Ideal for removing glass from under the bonnet.  
short side, 2-pack

Cut length mm	Part number	£ List Price excl. VAT
10	6 39 03 083 01 0	78.68
16	6 39 03 095 01 1	81.86
16	6 39 03 108 01 4	92.56
18	6 39 03 087 01 9	83.34
19,5	6 39 03 118 01 3	85.82
22	6 39 03 115 01 8	92.56
24	6 39 03 076 01 6	75.31
28	6 39 03 163 01 1	83.34
32	6 39 03 147 01 2	87.34
36	6 39 03 079 01 2	75.31
40	6 39 03 110 01 0	83.34
60	6 39 03 101 01 0	78.68
70	6 39 03 155 01 4	87.34



**U-shaped**  
Ideal for removing glass from under the bonnet.  
long side, 2-pack

Cut length mm	Part number	£ List Price excl. VAT
18	6 39 03 127 01 4	90.96
32	6 39 03 114 01 4	92.56
32	6 39 03 191 01 1	83.34
45	6 39 03 154 01 0	83.34
52	6 39 03 153 01 2	78.68
60	6 39 03 107 01 6	87.34



**U-shaped**  
Ideal for removing glass from under the bonnet.  
reinforced design, 2-pack

Cut length mm	Part number	£ List Price excl. VAT
60	6 39 03 157 01 1	78.68
95	6 39 03 111 01 9	87.34



**U-shaped**  
Ideal for removing glass from under the bonnet.  
reinforced design, toothed, 2-pack.

Cut length mm	Part number	£ List Price excl. VAT
19	6 39 03 210 01 6	52.74
22,5	6 39 03 211 01 5	52.74
38	6 39 03 212 01 8	52.74



**L-shaped**  
toothed, 2-pack.

Cut length mm	Part number	£ List Price excl. VAT
19	6 39 03 208 01 0	53.53
25,4	6 39 03 207 01 2	53.53
38	6 39 03 209 01 4	53.53



**Straight form**  
Pack of 2

Total length mm	Cut length mm	Part number	£ List Price excl. VAT
56	26	6 39 03 121 01 8	69.42
90	40	6 39 03 176 01 5	53.23
145	35	6 39 03 194 01 6	87.34



**Straight form**  
Z-bend, 2-pack.

Total length mm	Cut length mm	Part number	£ List Price excl. VAT
68	19	6 39 03 122 01 1	69.42
84	18	6 39 03 181 01 2	79.56
65	23	6 39 03 173 01 0	79.56
65	25	6 39 03 124 01 3	80.94
85	27	6 39 03 174 01 8	80.94
110	32	6 39 03 123 01 5	80.94
120	70	6 39 03 171 01 3	75.21



**Straight form**  
curved, 2-pack

Total length mm	Cut length mm	Part number	£ List Price excl. VAT
65	14	6 39 03 120 01 9	69.42
75	16	6 39 03 104 01 5	62.55
75	35	6 39 03 103 01 7	46.82
75	35	6 39 03 109 01 8	51.17
75	35	6 39 03 172 01 6	52.05



**Straight form**  
curved, Z-bend, 2-pack

Total length mm	Cut length mm	Part number	£ List Price excl. VAT
120	45	6 39 03 168 01 8	75.21
120	70	6 39 03 125 01 7	75.21



**Straight form**  
Z-bend, with rigid depth stop, 2-pack.

Total length mm	Cut length mm	Part number	£ List Price excl. VAT
120	16	6 39 03 099 01 0	77.28
125	58	6 39 03 097 01 8	78.68



**Straight form**  
Z-bend, with adjustable depth stop, 2-pack

Total length mm	Cut length mm	Part number	£ List Price excl. VAT
100	16-43	6 39 03 143 01 3	105.62
100	18-39	6 39 03 170 01 4	103.80
100	20-35	6 39 03 198 01 5	105.62
100	60-76	6 39 03 169 01 2	105.62



**Straight form**  
flat, with adjustable depth stop, 2-pack.

Total length mm	Cut length mm	Part number	£ List Price excl. VAT
145	42-60	6 39 03 182 01 5	87.34



**Straight form**  
Z-bend, bent with rigid depth stop, 2-pack.

Total length mm	Cut length mm	Part number	£ List Price excl. VAT
120	54	6 39 03 160 01 5	84.61



**Curved form**  
Z-bend, with rigid depth stop, 2-pack.

Total length mm	Cut length mm	Part number	£ List Price excl. VAT
80	14	6 39 03 082 01 6	78.68
80	16	6 39 03 133 01 4	77.28
85	39	6 39 03 152 01 8	78.68



**Curved form**  
Z-bend, with adjustable depth stop, 2-pack

Total length mm	Cut length mm	Part number	£ List Price excl. VAT
110	32-46	6 39 03 195 01 0	105.62

**Cargo accessories**



**L-shaped**  
toothed, 2-pack.

Cut length mm	Part number	£ List Price excl. VAT
25,4	6 39 03 207 01 2	53.53
38	6 39 03 209 01 4	53.53



**Straight form**  
suitable for round grooves in plastics.  
toothed, 2-pack.

Total length mm	Cut length mm	Part number	£ List Price excl. VAT
56	35	6 39 03 073 01 1	53.23



**Straight form**  
Suitable for removal of chassis attachment parts.  
Z-bend, toothed, 2-pack.

Total length mm	Cut length mm	Part number	£ List Price excl. VAT
120	60	6 39 03 081 01 3	75.21



**Straight form**  
Z-bend, 2-pack.

Total length mm	Cut length mm	Part number	£ List Price excl. VAT
120	60	6 39 03 216 01 7	73.26



**Straight form**  
Angle cutter, 2-pack.

Total length mm	Cut length mm	Part number	£ List Price excl. VAT
85	65/8	6 39 03 177 01 9	77.07
83	35/20	6 39 03 203 01 3	77.07



**Curved form**  
Z-bend, 2-pack.

Total length mm	Cut length mm	Part number	£ List Price excl. VAT
80	45	6 39 03 072 01 7	75.24



**U-shaped**  
with elongated traverse, 2-pack.

Cut length mm	Part number	£ List Price excl. VAT
40	6 39 03 156 01 7	92.82



**Hook-shaped**  
toothed, 2-pack.

Cut length mm	Part number	£ List Price excl. VAT
38	6 39 03 217 01 1	52.74



**Segment blade**  
Segment form for V-cut from outside and for cuts in corners,  
2-pack

Total length mm	Cut length mm	Part number	£ List Price excl. VAT
73	30	6 39 03 132 01 0	51.85



**Traction cable**  
with grip. Use is recommended when cutting out from outside  
with L-shaped or hook-shaped cutter blade. Easier work and  
less effort when cutting out glass panes from problem spots on  
buses, commercial vehicles, trams and locomotives.

Part number	£ List Price excl. VAT
9 26 02 030 01 4	17.36



**Work gloves**  
Vibration-attenuating, certified according to EN 388/420,  
EN ISO 10819, EEC No. 0200, No. in pack 1 pair

Size	Part number	£ List Price excl. VAT
9 L	3 21 73 003 00 3	100.18
10 XL	3 21 73 004 00 1	100.18
11 XXL	3 21 73 005 00 5	100.18



**Bail handle**  
To reduce the vibrations and for better handling of the FEIN  
SUPERCUT during longer jobs. Can be used in connection with  
the dust extraction device 9 26 02 084 01 0.

Part number	£ List Price excl. VAT
3 21 19 116 01 1	46.85

**Accessory sets**



**Automobile glazier accessory set**  
Consisting of: 3 L-shaped cutter blades, toothed (form 207);  
2 L-shaped cutter blades, toothed (form 208); 1 L-shaped cutter  
blade, toothed (form 209); 1 each of U-shaped cutter blade,  
reinforced version (form 157 and 111); 2 U-shaped cutter  
blades, reinforced version, toothed (form 212); 1 straight cutter  
blade, Z-bend with adjustable stop roller (form 143); 1 straight  
cutter blade, Z-bend, toothed (form 081).

Part number	£ List Price excl. VAT
6 39 03 167 38 3	218.73



**Automobile workshop accessories set**  
Consisting of: 2 U-shaped cutter blades, short side (form 076);  
2 U-shaped cutter blades, short side (1x form 079 and  
1x form 101); 2 L-shaped cutter blades, toothed (form 207);  
1 L-shaped cutter blade, toothed (form 208); 1 U-shaped cutter  
blade, reinforced (form 157); 1 straight cutter blade, Z-bend,  
with adjustable stop roller (form 143); 1 shovel-shaped scraper  
blade, with scrape protection coating (form 129); 1 stopper  
knife; 1 HSS saw blade (Ø 80 mm).

Part number	£ List Price excl. VAT
6 39 03 167 25 7	218.73



**Accessory set for cargo**  
Subsequent order to Professional set Cargo consisting of:  
2 straight cutter blades, toothed (form 073), 1 straight cutter  
blade, Z-bend, toothed (form 081), 1 hook-shaped cutter blade,  
toothed (form 217), 1 curved cutter blade, Z-bend, (form 072),  
1 each of L-shaped cutter blade, toothed (forms 207 and 209),  
1 spade-shaped scraper knife, with scratch-protective coating  
(form 105), 1 traction cable, 1 depth stop

Part number	£ List Price excl. VAT
6 39 03 167 32 0	218.73

**Accessories for AFSC 1.7 Q**



**Quick charger ALG 50**  
For all FEIN Li-ion batteries. Charge time from 35 min.

Part number	£ List Price excl. VAT
9 26 04 129 01 0	45.53



**Quick charger ALG 30**  
For FEIN NiCd and Li-ion batteries. Charge time from 25 min.

Part number	£ List Price excl. VAT
9 26 04 096 01 0	163.10



**Battery pack**  
Li-ion battery with charge status indicator and FEIN SafetyCell  
technology. Protects the battery and tool from overload,  
overheating and total discharge. Can be used with all FEIN 18 V  
cordless tools.

Current/Voltages V	Capacity Ah	Part number	£ List Price excl. VAT
18	5	9 26 04 173 02 0	111.38
18	2,5	9 26 04 171 02 0	76.34

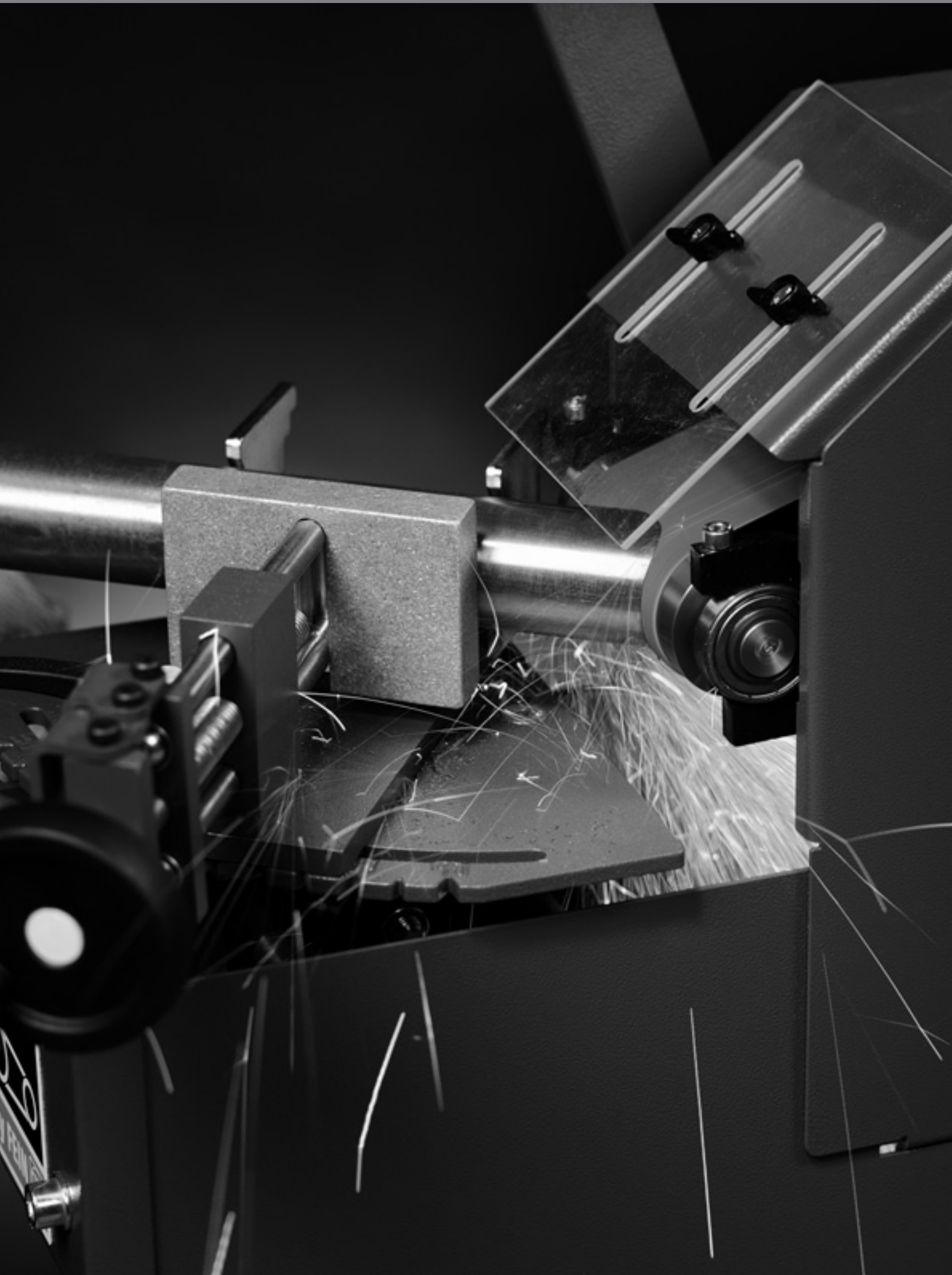



## GRIT – The brand for belt grinding from FEIN

GRIT by FEIN – the name that stands for modular belt grinders that are optimally adapted to metalworking and metal machining applications. A highly economical system for all standards and requirements – for belt grinding, deburring, radial grinding or centreless grinding. This system is suitable for all applications involving steel and stainless steel. Powerful basic belt grinders and specific add-on modules cover all the main belt grinding applications in industry and the manual trades. The high quality standards of GRIT machines also apply to our accessories and grinding belts. We believe that grinding belts should be of premium quality – for maximum sanding capacity and outstanding service lives in metal machining. This makes genuine GRIT

grinding belts very cost-effective to use. You will find more detailed information about the GRIT range in the GRIT product brochure or at [www.fein.com](http://www.fein.com).



---

### GRIT GHB hand-guided belt grinder Page 184

The belt grinding system for various applications, can be used for mobile or stationary jobs.



---

### GRIT GHB add-on modules Page 186

The perfect addition for GRIT GHB – modules for surface processing, pipe notching and belt grinding.



---

### GRIT GX basic belt grinder for manual trades Page 188

Stationary belt grinders for use in trade and small-scale volume production.

---

### GRIT GX add-on modules for manual trades Page 190



---

### GRIT GI basic belt grinder for industry Page 192

Stationary belt grinders for use in industry and volume production.

---

### GRIT GI add-on modules for industry Page 194





---

### GRIT GKS compact belt grinder Page 199

The space-saving and economical solution for the workshop.

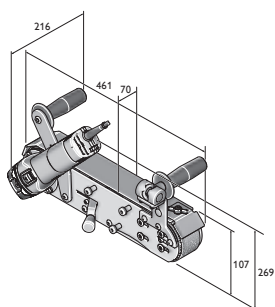

		<b>GRIT GHB 15-50</b>	<b>GRIT GHB 15-50 Inox</b>
		Powerful handheld belt grinder for flexible on-site use.	Universal handheld belt grinder for on-site problem-solving, ideal for stainless steel processing.
<b>EAN 4014586...</b>		... 880426	... 880457
<b>Page</b>		185	185
<b>Technical features</b>	Input	1,5 kW	1,5 kW
	Current/Voltages	1 x 230 V	1 x 230 V
	Speed, no load	8 500 1/min	2 500 - 7 900 1/min
	Belt size	50 x 1 000 mm	50 x 1 000 mm
	Weight according to EPTA	5,60 kg	5,60 kg



GHB 15-50  
GHB 15-50 Inox



Type	Part number	EAN	PC	£ List Price excl. VAT
<b>GRIT GHB 15-50</b>	<b>7 903 01 00 23 2</b>	<b>4014586880426</b>	<b>01</b>	<b>828.00</b>

**Price includes:**  
1 grinding belt 50 x 1 000 mm (K 36)  
For accessories, see page 186



Type	Part number	EAN	PC	£ List Price excl. VAT
<b>GRIT GHB 15-50 Inox</b>	<b>7 903 02 00 23 2</b>	<b>4014586880457</b>	<b>01</b>	<b>908.00</b>

**Price includes:**  
1 grinding belt 50 x 1 000 mm (K 36)  
For accessories, see page 186



Type	Part number	EAN	PC	£ List Price excl. VAT
<b>GRIT GHBD</b>	<b>9 90 01 012 00 0</b>	<b>4014586880488</b>	<b>01</b>	<b>278.00</b>

**Price includes:**  
1 GHBD module

For accessories, see page 186



Type	Part number	EAN	PC	£ List Price excl. VAT
<b>GRIT GHBM</b>	<b>9 90 01 012 01 0</b>	<b>4014586886992</b>	<b>01</b>	<b>534.00</b>

**Price includes:**  
1 GHBM module

For accessories, see page 186



Type	Part number	EAN	PC	£ List Price excl. VAT
<b>GRIT GHBR</b>	<b>9 90 01 012 02 0</b>	<b>4014586887005</b>	<b>01</b>	<b>669.00</b>

**Price includes:**  
1 GHBR module

For accessories, see page 186



Type	Part number	EAN	PC	£ List Price excl. VAT
<b>GRIT GHBML</b>	<b>9 90 01 012 03 0</b>	<b>4014586887548</b>	<b>01</b>	<b>818.00</b>

**Price includes:**  
1 GHBML module, 1 dust collecting vessel, 1 anti-vibration handle, 1 guide with lateral continuous adjustment

For accessories, see page 186



Type	Part number	EAN	PC	£ List Price excl. VAT
<b>GRIT GHBK</b>	<b>9 90 01 012 04 0</b>	<b>4014586888316</b>	<b>01</b>	<b>679.00</b>

**Price includes:**  
1 x GHBK module, 1 x dust and spark box, 1 x fixing element, 1 x spark protection cover, 2 x anti-vibration handles

For accessories, see page 186

## GRIT GHB hand-guided belt grinder

### Grinding belts



#### 3M™ Cubitron™ II

Precision grinding belt with ceramic grain guarantees maximum performance and service life. The evenly shaped ceramic grains produce a uniquely accurate feel during machining. The result is cool grinding without tarnishing and better surface quality.  
50 x 1 000 mm



#### 3M™ Cubitron™ II

Precision grinding belt with ceramic grain guarantees maximum performance and service life. The evenly shaped ceramic grains produce a uniquely accurate feel during machining. The result is cool grinding without tarnishing and better surface quality.  
50 x 1150 mm, for pipe notching with GRIT GHBR module.

Grain	No. in pack pcs	Part number	£ List Price excl. VAT
36	10	6 99 03 126 00 0	183.52
60	10	6 99 03 127 00 0	161.25
80	10	6 99 03 128 00 0	141.56

Grain	No. in pack pcs	Part number	£ List Price excl. VAT
36	10	6 99 03 157 00 0	193.98



**Grinding material Z**

It's the all-rounder for grinding and deburring steel and non-ferrous metals which also satisfies the most stringent requirements. Developed in collaboration with professional users, this grinding material features an impressively long service life and high performance and is cost-effective to use. Heavy polyester fabric, fully bonded with artificial resins, with zirconium corundum.  
50 x 1 000 mm

Grain	No. in pack pcs	Part number	£ List Price excl. VAT
36	10	6 99 03 130 00 0	69.51
60	10	6 99 03 131 00 0	47.18
80	10	6 99 03 132 00 0	43.25
120	10	6 99 03 133 00 0	35.40



**Grinding material Z**

It's the all-rounder for grinding and deburring steel and non-ferrous metals which also satisfies the most stringent requirements. Developed in collaboration with professional users, this grinding material features an impressively long service life and high performance and is cost-effective to use. Heavy polyester fabric, fully bonded with artificial resins, with zirconium corundum.  
50 x 1150 mm, for pipe notching with GRIT GHBR module.

Grain	No. in pack pcs	Part number	£ List Price excl. VAT
36	10	6 99 03 159 00 0	73.43

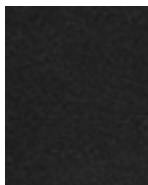

**Grinding material A**

Grinding belts with fine grit for fine grinding of metals to final finish. For the best surface results. Heavy cotton fabric, fully bonded with artificial resins, with corundum.  
50 x 1 000 mm

Grain	No. in pack pcs	Part number	£ List Price excl. VAT
220	10	6 99 03 134 00 0	34.06
320	10	6 99 03 135 00 0	35.49
420	10	6 99 03 136 00 0	35.49

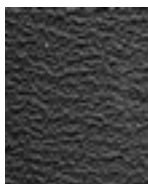

**Grinding material R**

It's the top grinding belt on the market, featuring superior service life and performance for considerably shorter working times. Especially recommended for machining stainless and high-alloy steel. Extra heavy polyester fabric, fully bonded with artificial resins, with zirconium corundum. Additional top layer for cooling during grinding.  
50 x 1 000 mm

Grain	No. in pack pcs	Part number	£ List Price excl. VAT
36	10	6 99 03 137 00 0	76.04
60	10	6 99 03 138 00 0	57.69
80	10	6 99 03 139 00 0	52.43
120	10	6 99 03 140 00 0	51.13

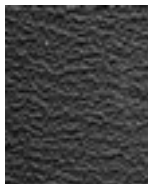

**Grinding material R**

It's the top grinding belt on the market, featuring superior service life and performance for considerably shorter working times. Especially recommended for machining stainless and high-alloy steel. Extra heavy polyester fabric, fully bonded with artificial resins, with zirconium corundum. Additional top layer for cooling during grinding.  
50 x 1150 mm, for pipe notching with GRIT GHBR module.

Grain	No. in pack pcs	Part number	£ List Price excl. VAT
36	10	6 99 03 158 00 0	80.37

**Fleece strips**

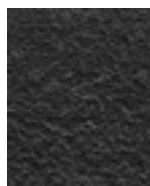

**Fleece belt**

Reliable for everything from covering up minor mistakes to a perfect finish. Long service lives make for cost-effective working.  
50 x 1 000 mm

Model	No. in pack pcs	Part number	£ List Price excl. VAT
very fine	3	6 99 03 144 00 0	60.30
medium	3	6 99 03 143 00 0	64.21
course	3	6 99 03 142 00 0	66.84

**Accessories for GHBR**



**Contact roller**

Long service lives, low roll resistance thanks to high-quality ball bearings, easy to interchange

Ø mm	Part number	£ List Price excl. VAT
16	6 99 02 000 40 9	70.00
18	6 99 02 000 41 0	70.00
19	6 99 02 000 41 1	70.00
20	6 99 02 000 41 2	70.00
21	6 99 02 000 41 3	70.00
21,3	6 99 02 000 41 4	70.00
22	6 99 02 000 41 5	70.00
25	6 99 02 000 41 6	70.00
25,4	6 99 02 000 41 7	70.00
26	6 99 02 000 41 8	70.00
26,9	6 99 02 000 41 9	70.00
27	6 99 02 000 42 0	70.00
28	6 99 02 000 42 1	70.00
28,8	6 99 02 000 42 2	70.00
30	6 99 02 000 42 3	70.00
31,7	6 99 02 000 42 4	70.00
32	6 99 02 000 42 5	70.00
33	6 99 02 000 42 6	70.00
33,7	6 99 02 000 42 7	70.00
34	6 99 02 000 42 8	70.00
35	6 99 02 000 42 9	70.00
38	6 99 02 000 43 0	70.00
38,1	6 99 02 000 43 1	70.00
38,3	6 99 02 000 43 2	70.00
40	6 99 02 000 43 3	70.00
42	6 99 02 000 43 4	70.00
42,4	6 99 02 000 43 5	70.00

**Other accessories for GRIT GHB**

**Stainless steel sanding support**

GRIT GHB 15-50 Inox

Part number	£ List Price excl. VAT
3 90 00 008 10 6	75.83



		<b>GRIT GX 75</b>	<b>GRIT GX 75 2H</b>
		Powerful belt grinder, modular expandable, for manual trades and for small series	Powerful belt grinder, modular expandable, for manual trades and for small series, ideal for machining stainless steel
<b>EAN 4014586...</b>		... 872018	... 872063
<b>Page</b>		189	189
<b>Technical features</b>	Input	3 kW	1,5 / 2 kW
	Current/Voltages	3 x 400/440V 50/60Hz	3 x 400/440V 50/60Hz
	Speed, no load	3 000 1/min	1 500 / 3 000 1/min
	Belt size	75 x 2 000 mm	75 x 2 000 mm
	Weight	75 kg	75 kg



Type	Part number	EAN	PC	£ List Price excl. VAT
<b>GRIT GX 75</b>	<b>7 901 31 00 40 3</b>	<b>4014586872018</b>	<b>13</b>	<b>1,234.00</b>

**Price includes:**

1 CEE plug (16 A), 1 grinding belt 75 x 2 000 mm (K 36 R)

For accessories, see page 201



Type	Part number	EAN	PC	£ List Price excl. VAT
<b>GRIT GX 75 2H</b>	<b>7 901 32 00 40 3</b>	<b>4014586872063</b>	<b>13</b>	<b>1,473.00</b>

**Price includes:**

1 grinding belt 75 x 2 000 mm (K 36 R), 1 CEE plug (16 A)

For accessories, see page 201



		GRIT GXE	GRIT GXC	GRIT GXW	GRIT GXR
		Highly effective deburring machine for manual trades and for small series	Cylindrical grinding module for perfect surfaces of metal and stainless steel pipes and shafts	Cooling lubricant module for a professional wet grinding	Radii-grinding module for precision fitting of pipes, profiles, and flat materials
<b>EAN 4014586...</b>		... 857879	... 871936	... 873145	... 871974
<b>Page</b>		191	191	191	191
<b>Technical features</b>	Input	2,2 kW	0,18 kW	0,12 kW	
	Current/Voltages	3 x 400/440V 50/60Hz	3 x 400/440V 50/60Hz	3 x 400/440V 50/60Hz	
	Speed, no load	1 500 1/min			
	Belt size		75 x 2 000 mm		75 x 2 250 mm
	Weight	32 kg	48 kg	8,6 kg	54 kg





Type	Part number	EAN	PC	£ List Price excl. VAT
<b>GRIT GXE</b>	<b>7 901 05 00 40 3</b>	<b>4014586857879</b>	<b>13</b>	<b>915.00</b>

**Price includes:**  
1 CEE plug (16 A)

For accessories, see page 201



Type	Part number	EAN	PC	£ List Price excl. VAT
<b>GRIT GXC</b>	<b>7 901 23 00 44 3</b>	<b>4014586871936</b>	<b>13</b>	<b>1,412.00</b>

**Price includes:**  
1 guide rail, nylon, 1 guide rail, brass, 1 CEE plug (16 A)

For accessories, see page 201



Type	Part number	EAN	PC	£ List Price excl. VAT
<b>GRIT GXW</b>	<b>7 901 24 00 44 3</b>	<b>4014586873145</b>	<b>13</b>	<b>778.00</b>

**Price includes:**  
1 litre cooling lubricant emulsion (1:30)

For accessories, see page 201



Type	Part number	EAN	PC	£ List Price excl. VAT
<b>GRIT GXR</b>	<b>9 90 01 001 00 1</b>	<b>4014586871974</b>	<b>13</b>	<b>1,366.00</b>

**Price includes:**  
1 contact roller  $\varnothing$  42.4 mm, 1 contact roller  $\varnothing$  48,3 mm, 1 grinding belt 75 x 2250 (K 36 R).

For accessories, see page 201



	GRIT GI 75	GRIT GI 75 2H	GRIT GI 100 EF	GRIT GI 100	GRIT GI 150	GRIT GI 150 2H	GRIT GIS 75	GRIT GIS 150	
	High-performance belt grinder, modular expandable, for industrial and series applications	High-performance belt grinder, modular expandable, for industrial and series applications, ideal for machining stainless steel	Powerful belt grinder in small format: for universal application on small workpieces		High-performance belt grinder, modular expandable, for industrial and series applications	High-performance belt grinder, modular expandable, for industrial and series applications, ideal for machining stainless steel	High-performance grinder for standard grinding tasks	High-performance grinder for standard grinding applications for extra-wide workpieces.	
<b>EAN 4014586...</b>	... 858913	... 858944	... 887043	... 887067	... 858999	... 859019	... 878126	... 878225	
<b>Page</b>	193	193	193	193	193	193	193	193	
<b>Technical features</b>	Input	4 kW	2,6 - 3,1 kW	1,5 kW	1,5 kW	4 kW	2,6 - 3,1 kW	4 kW	4 kW
	Current/Voltages	3 x 400/440V 50/60Hz	3 x 400/440V 50/60Hz	1 x 230 V	3 x 400/440V 50/60Hz	3 x 400/440V 50/60Hz	3 x 400/440V 50/60Hz	3 x 400/440V 50/60Hz	3 x 400/440V 50/60Hz
	Speed, no load	3 000 1/min	1 500 / 3 000 1/min	3 000 1/min	3 000 1/min	3 000 1/min	1 500 / 3 000 1/min	3 000 1/min	3 000 1/min
	Belt size	75 x 2 000 mm	75 x 2 000 mm	100 x 1 000 mm	100 x 1 000 mm	150 x 2 000 mm	150 x 2 000 mm	75 x 2 000 mm	150 x 2 000 mm
	Weight	65 kg	65 kg	29,8 kg	28,8 kg	82 kg	82 kg	74 kg	93 kg



Type	Part number	EAN	PC	£ List Price excl. VAT
<b>GRIT GI 75</b>	<b>7 902 01 00 40 3</b>	<b>4014586858913</b>	<b>13</b>	<b>1,884.00</b>

**Price includes:**  
1 CEE plug (16 A), 1 grinding belt 75 x 2 000 mm (K 36 R)  
For accessories, see page 201



Type	Part number	EAN	PC	£ List Price excl. VAT
<b>GRIT GI 75 2H</b>	<b>7 902 02 00 40 3</b>	<b>4014586858944</b>	<b>13</b>	<b>2,261.00</b>

**Price includes:**  
1 CEE plug (16 A), 1 grinding belt 75 x 2 000 mm (K 36 R)  
For accessories, see page 201



Type	Part number	EAN	PC	£ List Price excl. VAT
<b>GRIT GI 100 EF</b>	<b>7 902 23 00 23 2</b>	<b>4014586887043</b>	<b>13</b>	<b>1,394.00</b>

**Price includes:**  
1 grinding belt 100 x 1 000 (K 60 Z)  
For accessories, see page 201



Type	Part number	EAN	PC	£ List Price excl. VAT
<b>GRIT GI 100</b>	<b>7 902 23 00 40 3</b>	<b>4014586887067</b>	<b>13</b>	<b>1,156.00</b>

**Price includes:**  
1 grinding belt 100 x 1 000 (K 60 Z)  
For accessories, see page 201



Type	Part number	EAN	PC	£ List Price excl. VAT
<b>GRIT GI 150</b>	<b>7 902 04 00 40 3</b>	<b>4014586858999</b>	<b>13</b>	<b>2,277.00</b>

**Price includes:**  
1 CEE plug (16 A), 1 grinding belt 150 x 2 000 mm (K 36 R)  
For accessories, see page 201



Type	Part number	EAN	PC	£ List Price excl. VAT
<b>GRIT GI 150 2H</b>	<b>7 902 05 00 40 3</b>	<b>4014586859019</b>	<b>13</b>	<b>2,657.00</b>

**Price includes:**  
1 CEE plug (16 A), 1 grinding belt 150 x 2 000 mm (K 36 R)  
For accessories, see page 201



Type	Part number	EAN	PC	£ List Price excl. VAT
<b>GRIT GIS 75</b>	<b>7 902 29 50 44 3</b>	<b>4014586878126</b>	<b>13</b>	<b>1,677.00</b>

**Price includes:**  
1 CEE plug (16 A), 1 grinding belt 75 x 2 000 mm (K 36 R)  
For accessories, see page 201



Type	Part number	EAN	PC	£ List Price excl. VAT
<b>GRIT GIS 150</b>	<b>7 902 30 50 44 3</b>	<b>4014586878225</b>	<b>13</b>	<b>2,018.00</b>

**Price includes:**  
1 CEE plug (16 A), 1 grinding belt 150 x 2 000 mm (K 36 R)  
For accessories, see page 201



	GRIT GIE	GRIT GIC	GRIT GIMS 75	GRIT GIMS 150	GIMS 75 2H	GIMS 150 2H	GIMS 75-6	GIMS 150-6	
	Highly effective deburring machine for industrial deburring in series	Centreless grinding module for industrial centreless grinding in volume production	Mobile carriage for effective grinding "on site" at the floor						
<b>EAN 4014586...</b>	... 859057	... 867656	... 872599	... 872643	... 878614	... 878621	... 878645	... 878683	
<b>Page</b>	196	196	196	196	196	196	196	197	
<b>Technical features</b>	Input	1,5 / 2,0 kW	0,18 kW	4 kW	4 kW	2,6 - 3,1 kW	2,6 - 3,1 kW	6 kW	6 kW
	Current/Voltages	3 x 400/440V 50/60Hz	3 x 400/440V 50/60Hz	3 x 400/440V 50/60Hz	3 x 400/440V 50/60Hz	3 x 400/440V 50/60Hz	3 x 400/440V 50/60Hz	3 x 400/440V 50/60Hz	3 x 400/440V 50/60Hz
	Speed, no load	1 500 / 3 000 1/min		3 000 1/min	3 000 1/min	1 500 / 3 000 1/min	1 500 / 3 000 1/min	3 000 1/min	3 000 1/min
	Belt size		75/150 x 2 000 mm	75 x 2 000 mm	150 x 2 000 mm	75 x 2 000 mm	150 x 2 000 mm	75 x 2 000 mm	150 x 2 000 mm
	Weight	34 kg	65 kg	100 kg	110 kg	103 kg	114 kg	121 kg	131 kg



	<b>GRIT GILSGIB</b>	<b>GRIT GIL</b>	<b>GRIT GILS</b>	<b>GRIT GIB</b>	<b>GRIT GIBE</b>	<b>GRIT GIR</b>	<b>GRIT GIXBE</b>	<b>GRIT GIXS</b>
	Surface grinder for perfect longitudinal grinding of square pipes, profiles and flat materials in automatic processes	Plane grinding module for perfect longitudinal grinding of square pipes, profiles and flat materials	Surface grinder for perfect longitudinal grinding of square pipes, profiles and flat materials in automatic processes	Exceedingly sturdy machine base	Exceedingly sturdy machine base with integrated double extraction	Radii-grinding module for precision fitting of pipes, profiles and flat materials in series application	Integrated motor for effective suction	Sturdy machine base made of powder coated steel plate
	... 880921	... 880945	... 880976	... 859064	... 859071	... 878263	... 859125	... 858340
	197	197	197	197	197	198	198	198
	2,6 - 3,1 kW	0,18 kW	2,6 - 3,1 kW		0,35 kW		0,35 kW	
	3 x 400/440V 50/60Hz	3 x 400/440V 50/60Hz	3 x 400/440V 50/60Hz				3 x 400/440V 50/60Hz	
	1 500 / 3 000 1/min						1 500 / 3 000 1/min	
	150 x 2 000 mm	150 x 2 000 mm	150 x 2 000 mm			150 x 2 250 mm		
	189 kg	64 kg	206 kg	17 kg	55 kg	109 kg	58 kg	18 kg



Type	Part number	EAN	PC	£ List Price excl. VAT
<b>GRIT GIE</b>	<b>7 902 07 00 40 3</b>	<b>4014586859057</b>	<b>13</b>	<b>1,797.00</b>

**Price includes:**  
1 CEE plug (16 A)  
For accessories, see page 201



Type	Part number	EAN	PC	£ List Price excl. VAT
<b>GRIT GIC</b>	<b>7 902 12 00 44 3</b>	<b>4014586867656</b>	<b>13</b>	<b>3,067.00</b>

**Price includes:**  
1 guide rail, nylon, 1 guide rail, brass, 1 CEE plug (16 A)  
For accessories, see page 201



Type	Part number	EAN	PC	£ List Price excl. VAT
<b>GRIT GIMS 75</b>	<b>7 902 13 00 40 3</b>	<b>4014586872599</b>	<b>13</b>	<b>3,555.00</b>

For accessories, see page 201



Type	Part number	EAN	PC	£ List Price excl. VAT
<b>GRIT GIMS 150</b>	<b>7 902 14 00 40 3</b>	<b>4014586872643</b>	<b>13</b>	<b>4,004.00</b>

For accessories, see page 201



Type	Part number	EAN	PC	£ List Price excl. VAT
<b>GIMS 75 2H</b>	<b>7 902 16 00 40 3</b>	<b>4014586878614</b>	<b>13</b>	<b>4,317.00</b>

For accessories, see page 201



Type	Part number	EAN	PC	£ List Price excl. VAT
<b>GIMS 150 2H</b>	<b>7 902 17 00 40 3</b>	<b>4014586878621</b>	<b>13</b>	<b>4,606.00</b>

For accessories, see page 201



Type	Part number	EAN	PC	£ List Price excl. VAT
<b>GIMS 75-6</b>	<b>7 902 18 00 40 3</b>	<b>4014586878645</b>	<b>13</b>	<b>4,317.00</b>

For accessories, see page 201



Type	Part number	EAN	PC	£ List Price excl. VAT
<b>GIMS 150-6</b>	<b>7 902 19 00 40 3</b>	<b>4014586878683</b>	<b>13</b>	<b>4,606.00</b>

For accessories, see page 201



Type	Part number	EAN	PC	£ List Price excl. VAT
<b>GRIT GILSGIB</b>	<b>7 902 35 00 40 3</b>	<b>4014586880921</b>	<b>13</b>	<b>6,511.00</b>

**Price includes:**  
1 CEE plug (16 A), 1 grinding belt 150 x 2 000 mm (K 120 R)  
without dust extraction  
For accessories, see page 201



Type	Part number	EAN	PC	£ List Price excl. VAT
<b>GRIT GIL</b>	<b>7 902 48 00 40 3</b>	<b>4014586880945</b>	<b>13</b>	<b>3,136.00</b>

For accessories, see page 201



Type	Part number	EAN	PC	£ List Price excl. VAT
<b>GRIT GILS</b>	<b>7 902 51 00 40 3</b>	<b>4014586880976</b>	<b>13</b>	<b>8,068.00</b>

**Price includes:**  
1 grinding belt 150 x 2 000 mm (K 120 R), 1 CEE plug (16 A)  
with dust extraction  
For accessories, see page 201



Type	Part number	EAN	PC	£ List Price excl. VAT
<b>GRIT GIB</b>	<b>9 90 01 003 00 0</b>	<b>4014586859064</b>	<b>13</b>	<b>317.00</b>

For accessories, see page 201



Type	Part number	EAN	PC	£ List Price excl. VAT
<b>GRIT GIBE</b>	<b>9 90 01 004 00 0</b>	<b>4014586859071</b>	<b>13</b>	<b>1,805.00</b>

For accessories, see page 201

Belt grinders



Type	Part number	EAN	PC	£ List Price excl. VAT
<b>GRIT GIR</b>	<b>9 90 01 007 00 1</b>	<b>4014586878263</b>	<b>13</b>	<b>2,714.00</b>

For accessories, see page 201



Type	Part number	EAN	PC	£ List Price excl. VAT
<b>GRIT GIXBE</b>	<b>9 90 01 009 00 0</b>	<b>4014586859125</b>	<b>13</b>	<b>1,906.00</b>

For accessories, see page 201



Type	Part number	EAN	PC	£ List Price excl. VAT
<b>GRIT GIXS</b>	<b>9 90 01 002 00 0</b>	<b>4014586858340</b>	<b>13</b>	<b>289.00</b>

For accessories, see page 201





		GRIT GKS 75	GRIT GKS 75	GRIT GKS 75	GRIT GKS 75	GRIT GKS 75 2H
Compact belt grinder for metalwork. The economical solution for the workshop.						
<b>EAN 4014586...</b>		... 888255	... 888262	... 888279	... 888293	... 888309
<b>Page</b>		200	200	200	200	200
<b>Technical features</b>	Input	4 kW	1,1 kW	1,5 kW	3 kW	1,5 / 2 kW
	Current/Voltages	3 x 400/440V 50/60Hz	1 x 230 V	3 x 400/440V 50/60Hz	3 x 400/440V 50/60Hz	3 x 400/440V 50/60Hz
	Speed, no load	3 000 1/min	3 000 1/min	3 000 1/min	3 000 1/min	1 500 / 3 000 1/min
	Belt size	75 x 2 000 mm	75 x 2 000 mm	75 x 2 000 mm	75 x 2 000 mm	75 x 2 000 mm
	Weight	50 kg	45 kg	45 kg	50 kg	45 kg



Type	Part number	EAN	PC	£ List Price excl. VAT
<b>GRIT GKS 75</b>	<b>7 905 01 00 40 3</b>	<b>4014586888255</b>	<b>13</b>	<b>1,306.00</b>

**Price includes:**  
1 grinding belt 75 x 2 000 mm (K 36 R)  
For accessories, see page 201



Type	Part number	EAN	PC	£ List Price excl. VAT
<b>GRIT GKS 75</b>	<b>7 905 02 00 23 2</b>	<b>4014586888262</b>	<b>13</b>	<b>1,097.00</b>

**Price includes:**  
1 grinding belt 75 x 2 000 mm (K 36 R)  
For accessories, see page 201



Type	Part number	EAN	PC	£ List Price excl. VAT
<b>GRIT GKS 75</b>	<b>7 905 02 00 40 3</b>	<b>4014586888279</b>	<b>13</b>	<b>888.00</b>

**Price includes:**  
1 grinding belt 75 x 2 000 mm (K 36 R)  
For accessories, see page 201



Type	Part number	EAN	PC	£ List Price excl. VAT
<b>GRIT GKS 75</b>	<b>7 905 03 00 40 3</b>	<b>4014586888293</b>	<b>13</b>	<b>993.00</b>

**Price includes:**  
1 grinding belt 75 x 2 000 mm (K 36 R)  
For accessories, see page 201



Type	Part number	EAN	PC	£ List Price excl. VAT
<b>GRIT GKS 75 2H</b>	<b>7 905 04 00 40 3</b>	<b>4014586888309</b>	<b>13</b>	<b>1,045.00</b>

**Price includes:**  
1 grinding belt 75 x 2 000 mm (K 36 R)  
For accessories, see page 201



**Grinding belts**



**3M™ Cubitron™ II**

Precision grinding belt with ceramic grain guarantees maximum performance and service life. The evenly shaped ceramic grains produce a uniquely accurate feel during machining. The result is cool grinding without tarnishing and better surface quality.  
75 x 2 000 mm

Grain	No. in pack pcs	Part number	£ List Price excl. VAT
36	10	6 99 03 145 00 0	265.76
60	10	6 99 03 146 00 0	225.63
80	10	6 99 03 147 00 0	240.86



**3M™ Cubitron™ II**

Precision grinding belt with ceramic grain guarantees maximum performance and service life. The evenly shaped ceramic grains produce a uniquely accurate feel during machining. The result is cool grinding without tarnishing and better surface quality.  
75 x 2250 mm, for pipe notching with GRIT GXR module.

Grain	No. in pack pcs	Part number	£ List Price excl. VAT
36	10	6 99 03 151 00 0	346.57
60	10	6 99 03 152 00 0	295.73
80	10	6 99 03 153 00 0	281.00



**3M™ Cubitron™ II**

Precision grinding belt with ceramic grain guarantees maximum performance and service life. The evenly shaped ceramic grains produce a uniquely accurate feel during machining. The result is cool grinding without tarnishing and better surface quality.  
150 x 2 000 mm

Grain	No. in pack pcs	Part number	£ List Price excl. VAT
36	10	6 99 03 148 00 0	555.33
60	10	6 99 03 149 00 0	462.99
80	10	6 99 03 150 00 0	434.90



**3M™ Cubitron™ II**

Precision grinding belt with ceramic grain guarantees maximum performance and service life. The evenly shaped ceramic grains produce a uniquely accurate feel during machining. The result is cool grinding without tarnishing and better surface quality.  
150 x 2250 mm, for pipe notching with GRIT GIR module.

Grain	No. in pack pcs	Part number	£ List Price excl. VAT
36	10	6 99 03 154 00 0	640.95
60	10	6 99 03 155 00 0	536.59
80	10	6 99 03 156 00 0	504.47

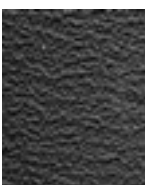

**Grinding material R**

It's the top grinding belt on the market, featuring superior service life and performance for considerably shorter working times. Especially recommended for machining stainless and high-alloy steel. Extra heavy polyester fabric, fully bonded with artificial resins, with zirconium corundum. Additional top layer for cooling during grinding.  
75 x 2 000 mm

Grain	No. in pack pcs	Part number	£ List Price excl. VAT
24	10	6 99 03 000 00 0	168.83
36	10	6 99 03 002 00 0	137.62
40	10	6 99 03 004 00 0	125.72
60	10	6 99 03 007 00 0	115.62
80	10	6 99 03 009 00 0	108.64
120	10	6 99 03 013 00 0	103.27

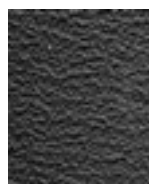

**Grinding material R**

It's the top grinding belt on the market, featuring superior service life and performance for considerably shorter working times. Especially recommended for machining stainless and high-alloy steel. Extra heavy polyester fabric, fully bonded with artificial resins, with zirconium corundum. Additional top layer for cooling during grinding.  
75 x 2250 mm, for pipe notching with GRIT GXR module.

Grain	No. in pack pcs	Part number	£ List Price excl. VAT
36	10	6 99 03 020 00 0	154.11

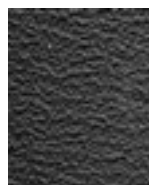

**Grinding material R**

It's the top grinding belt on the market, featuring superior service life and performance for considerably shorter working times. Especially recommended for machining stainless and high-alloy steel. Extra heavy polyester fabric, fully bonded with artificial resins, with zirconium corundum. Additional top layer for cooling during grinding.  
75 x 2300 mm, for pipe notching with GRIT GXR module for contact rollers with diameter > 80 mm.

Grain	No. in pack pcs	Part number	£ List Price excl. VAT
36	10	6 99 03 122 00 0	148.42

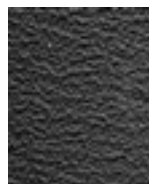

**Grinding material R**

It's the top grinding belt on the market, featuring superior service life and performance for considerably shorter working times. Especially recommended for machining stainless and high-alloy steel. Extra heavy polyester fabric, fully bonded with artificial resins, with zirconium corundum. Additional top layer for cooling during grinding.  
150 x 2 000 mm

Grain	No. in pack pcs	Part number	£ List Price excl. VAT
24	10	6 99 03 039 00 0	288.82
36	10	6 99 03 040 00 0	239.66
40	10	6 99 03 042 00 0	236.64
60	10	6 99 03 044 00 0	209.20
80	10	6 99 03 046 00 0	196.75
120	10	6 99 03 048 00 0	179.68

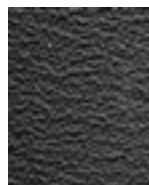

**Grinding material R**

It's the top grinding belt on the market, featuring superior service life and performance for considerably shorter working times. Especially recommended for machining stainless and high-alloy steel. Extra heavy polyester fabric, fully bonded with artificial resins, with zirconium corundum. Additional top layer for cooling during grinding.  
150 x 2250 mm, for pipe notching with GRIT GIR module.

Grain	No. in pack pcs	Part number	£ List Price excl. VAT
36	10	6 99 03 053 00 0	298.83

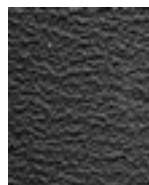

**Grinding material R**

It's the top grinding belt on the market, featuring superior service life and performance for considerably shorter working times. Especially recommended for machining stainless and high-alloy steel. Extra heavy polyester fabric, fully bonded with artificial resins, with zirconium corundum. Additional top layer for cooling during grinding.  
150 x 2400 mm, for pipe notching with GRIT GIR module for contact rollers with diameter > 170 mm.

Grain	No. in pack pcs	Part number	£ List Price excl. VAT
36	10	6 99 03 111 00 0	306.70



**Grinding material Z**

It's the all-rounder for grinding and deburring steel and non-Ferrous metals which also satisfies the most stringent requirements. Developed in collaboration with professional users, this grinding material features an impressively long service life and high performance and is cost-effective to use. Heavy polyester fabric, fully bonded with artificial resins, with zirconium corundum.  
75 x 2 000 mm

Grain	No. in pack pcs	Part number	£ List Price excl. VAT
36	10	6 99 03 003 00 0	104.44
40	10	6 99 03 005 00 0	99.18
60	10	6 99 03 008 00 0	87.81
80	10	6 99 03 010 00 0	82.52
120	10	6 99 03 014 00 0	78.34



**Grinding material Z**

It's the all-rounder for grinding and deburring steel and non-ferrous metals which also satisfies the most stringent requirements. Developed in collaboration with professional users, this grinding material features an impressively long service life and high performance and is cost-effective to use. Heavy polyester fabric, fully bonded with artificial resins, with zirconium corundum.  
75 x 2250 mm, for pipe notching with GRIT GXR module.

Grain	No. in pack pcs	Part number	£ List Price excl. VAT
36	10	6 99 03 021 00 0	116.94



**Grinding material Z**

It's the all-rounder for grinding and deburring steel and non-ferrous metals which also satisfies the most stringent requirements. Developed in collaboration with professional users, this grinding material features an impressively long service life and high performance and is cost-effective to use. Heavy polyester fabric, fully bonded with artificial resins, with zirconium corundum.  
100 x 1 000 mm

Grain	No. in pack pcs	Part number	£ List Price excl. VAT
36	10	6 99 03 034 00 0	73.20
40	10	6 99 03 035 00 0	69.64
60	10	6 99 03 036 00 0	59.20
80	10	6 99 03 037 00 0	57.95
120	10	6 99 03 038 00 0	53.00



**Grinding material Z**

It's the all-rounder for grinding and deburring steel and non-ferrous metals which also satisfies the most stringent requirements. Developed in collaboration with professional users, this grinding material features an impressively long service life and high performance and is cost-effective to use. Heavy polyester fabric, fully bonded with artificial resins, with zirconium corundum.  
150 x 2 000 mm

Grain	No. in pack pcs	Part number	£ List Price excl. VAT
36	10	6 99 03 041 00 0	194.57
40	10	6 99 03 043 00 0	184.96
60	10	6 99 03 045 00 0	163.76
80	10	6 99 03 047 00 0	153.92
120	10	6 99 03 049 00 0	140.38



**Grinding material Z**

It's the all-rounder for grinding and deburring steel and non-ferrous metals which also satisfies the most stringent requirements. Developed in collaboration with professional users, this grinding material features an impressively long service life and high performance and is cost-effective to use. Heavy polyester fabric, fully bonded with artificial resins, with zirconium corundum.  
150 x 2250 mm, for pipe notching with GRIT GIR module.

Grain	No. in pack pcs	Part number	£ List Price excl. VAT
36	10	6 99 03 054 00 0	233.77



**Grinding material Z**

It's the all-rounder for grinding and deburring steel and non-ferrous metals which also satisfies the most stringent requirements. Developed in collaboration with professional users, this grinding material features an impressively long service life and high performance and is cost-effective to use. Heavy polyester fabric, fully bonded with artificial resins, with zirconium corundum.  
150 x 2400 mm, for pipe notching with GRIT GIR module for contact rollers with diameter > 170 mm.

Grain	No. in pack pcs	Part number	£ List Price excl. VAT
36	10	6 99 03 112 00 0	239.85

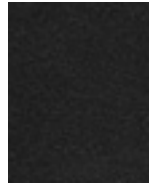

**Grinding material A**

Grinding belts with fine grit for fine grinding of metals to final finish. For the best surface results. Heavy cotton fabric, fully bonded with artificial resins, with corundum.  
75 x 2 000 mm

Grain	No. in pack pcs	Part number	£ List Price excl. VAT
220	10	6 99 03 017 00 0	76.32
320	10	6 99 03 018 00 0	76.32
400	10	6 99 03 019 00 0	73.38

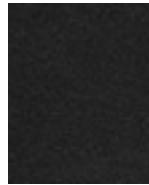

**Grinding material A**

Grinding belts with fine grit for fine grinding of metals to final finish. For the best surface results. Heavy cotton fabric, fully bonded with artificial resins, with corundum.  
150 x 2 000 mm

Grain	No. in pack pcs	Part number	£ List Price excl. VAT
220	10	6 99 03 050 00 0	138.96
320	10	6 99 03 051 00 0	144.47
400	10	6 99 03 052 00 0	144.47

**Fleece strips**



**Fleece belt**

Reliable for everything from covering up minor mistakes to a perfect finish. Long service lives make for cost-effective working.  
75 x 2 000 mm

Model	No. in pack pcs	Part number	£ List Price excl. VAT
very fine	3	6 99 03 121 01 0	204.40
medium	3	6 99 03 119 01 0	212.50
course	3	6 99 03 117 01 0	212.50

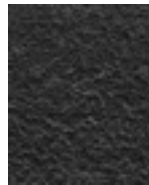

**Fleece belt**

Reliable for everything from covering up minor mistakes to a perfect finish. Long service lives make for cost-effective working.  
150 x 2 000 mm

Model	No. in pack pcs	Part number	£ List Price excl. VAT
very fine	3	6 99 03 120 01 0	424.92
medium	3	6 99 03 118 01 0	424.92
course	3	6 99 03 116 01 0	424.92



**Accessories for GRIT GX 75 / GX 75 2H**



**Stainless steel sanding support**  
GX 75

Part number	£ List Price excl. VAT
6 99 02 338 00 0	171.35



**Graphite pad**  
As sliding base for surface grinding.

No. in pack pcs	Part number	£ List Price excl. VAT
5	3 90 00 000 00 1	106.40



**Eye protection**  
Acrylic screen for protection against sparks

No. in pack pcs	Part number	£ List Price excl. VAT
3	3 90 00 000 00 4	47.85



**Spark box**  
with interfaces to extraction unit.

Part number	£ List Price excl. VAT
6 99 02 343 00 0	122.00

**Accessories GRIT GXR**

**Stainless steel jaws**  
Interchangeable, for vice when machining stainless steel.

Part number	£ List Price excl. VAT
6 99 02 004 00 0	177.39



**Length stop**  
1000 mm long, continuously variable, easy to fit

Part number	£ List Price excl. VAT
6 99 02 001 00 0	191.00



**Contact roller**  
Long service lives, low roll resistance thanks to high-quality ball bearings, easy to interchange

Ø mm	Part number	£ List Price excl. VAT
16	6 99 02 020 00 0	124.00
17	6 99 02 021 00 0	124.00
17,2	6 99 02 022 00 0	114.03
18	6 99 02 023 00 0	114.03
19	6 99 02 024 00 0	124.00
20	6 99 02 025 00 0	124.00
21	6 99 02 026 00 0	124.00
21,3	6 99 02 027 00 0	114.03
22	6 99 02 028 00 0	124.00
22,2	6 99 02 029 00 0	124.00
22,5	6 99 02 030 00 0	124.00
23	6 99 02 031 00 0	114.03
23,1	6 99 02 032 00 0	114.03
24	6 99 02 033 00 0	114.03
24,5	6 99 02 034 00 0	114.03
25	6 99 02 035 00 0	124.00
25,4	6 99 02 036 00 0	124.00
25,9	6 99 02 037 00 0	114.03
26	6 99 02 038 00 0	124.00
26,4	6 99 02 039 00 0	114.03
26,9	6 99 02 040 00 0	124.00
27	6 99 02 041 00 0	114.03

28	6 99 02 042 00 0	114.03
28,6	6 99 02 043 00 0	124.00
28,8	6 99 02 044 00 0	114.03
29	6 99 02 045 00 0	114.03
30	6 99 02 046 00 0	124.00
31,7	6 99 02 047 00 0	124.00
32	6 99 02 048 00 0	124.00
33	6 99 02 049 00 0	124.00
33,7	6 99 02 050 00 0	124.00
34	6 99 02 051 00 0	114.03
35	6 99 02 052 00 0	124.00
36	6 99 02 053 00 0	124.00
37,5	6 99 02 054 00 0	114.03
38	6 99 02 055 00 0	124.00
38,1	6 99 02 056 00 0	124.00
38,3	6 99 02 057 00 0	114.03
40	6 99 02 058 00 0	114.03
41	6 99 02 059 00 0	114.03
41,2	6 99 02 060 00 0	124.00
42	6 99 02 061 00 0	124.00
42,4	6 99 02 062 00 0	124.00
42,6	6 99 02 063 00 0	114.03
43	6 99 02 064 00 0	124.00
43,3	6 99 02 065 00 0	114.03
44	6 99 02 066 00 0	114.03
44,5	6 99 02 067 00 0	124.00
45	6 99 02 068 00 0	124.00
46	6 99 02 069 00 0	114.03
48	6 99 02 070 00 0	124.00
48,3	6 99 02 071 00 0	124.00
49	6 99 02 072 00 0	114.03
50	6 99 02 073 00 0	124.00
50,8	6 99 02 074 00 0	153.00
51	6 99 02 075 00 0	153.00
53	6 99 02 076 00 0	140.48
53,7	6 99 02 077 00 0	140.48
54	6 99 02 078 00 0	140.48
55	6 99 02 079 00 0	153.00
57	6 99 02 080 00 0	140.48
58	6 99 02 081 00 0	140.48
59	6 99 02 082 00 0	140.48
60	6 99 02 083 00 0	153.00
60,3	6 99 02 084 00 0	153.00
63	6 99 02 085 00 0	140.48
63,5	6 99 02 086 00 0	153.00
65	6 99 02 087 00 0	140.48
67	6 99 02 088 00 0	140.48
69	6 99 02 089 00 0	140.48
70	6 99 02 090 00 0	153.00
73	6 99 02 091 00 0	153.00
75	6 99 02 092 00 0	153.00
76	6 99 02 093 00 0	160.31
76,1	6 99 02 094 00 0	160.31
76,2	6 99 02 095 00 0	175.00
80	6 99 02 096 00 0	160.31
82,5	6 99 02 097 00 0	160.31
88,9	6 99 02 098 00 0	160.31
90	6 99 02 099 00 0	175.00



**Eye protection GU75/GR/GXR (3 pieces)**

Part number	£ List Price excl. VAT
3 90 00 000 00 7	78.86



**Dust container**

Plastic, to douse sparks, with handles on the sides, capacity about 15 l

Part number  
3 90 00 000 38 5

£ List Price  
excl. VAT  
POA



**Connecting piece**

Required for adapting the GXR module to a belt grinder of the GI program

Part number  
6 99 02 186 00 0

£ List Price  
excl. VAT  
90.88

**Accessories for machines GXC**



**Pipe support**

Ø 10-130 mm

Part number  
6 99 02 179 60 0

£ List Price  
excl. VAT  
268.18



**Pipe support**

Ø 10-160 mm

Can be combined with one another depending on the pipe length desired.

max. pipe length  
mm

Part number

1 000

6 99 02 180 60 0

£ List Price  
excl. VAT  
475.00



**Pipe support**

Ø 10-160 mm

Can be combined with one another depending on the pipe length desired.

max. pipe length  
mm

Part number

1 500

6 99 02 181 60 0

£ List Price  
excl. VAT  
1,188.00



**Guide rail, brass**

For dry grinding and course material surfaces

Part number  
3 90 00 000 49 6

£ List Price  
excl. VAT  
51.88



**Nylon glide support**

For high surface quality

Part number  
3 90 00 000 49 7

£ List Price  
excl. VAT  
57.86



**Connecting piece**

Required for adapting the GXC module to a belt grinder of the GI program

Part number  
6 99 02 187 00 0

£ List Price  
excl. VAT  
114.00

**Accessories GRIT GXE**



**Stainless steel sanding support**

GXE

Part number  
6 99 02 344 00 0

£ List Price  
excl. VAT  
59.59



**Steel wire brush**

Ø 250 mm x 60 mm, with very high wire drawing strength for highly efficient use, mounting hole Ø 51 mm. 0.2 mm thick wire for thin-walled pipes and profiles. 0.35 mm-thick wire for universal use. 0.5 mm thick wire for thick-walled pipes and profiles and great deburring results. Steel version

Wire thickness  
mm

Part number

0,2

6 99 02 006 00 0

£ List Price  
excl. VAT

218.66

0,35

6 99 02 007 00 0

200.00

0,5

6 99 02 008 00 0

200.00



**Steel wire brush**

Ø 250 mm x 60 mm, with very high wire drawing strength for highly efficient use, mounting hole Ø 51 mm. 0.2 mm thick wire for thin-walled pipes and profiles. 0.35 mm-thick wire for universal use. 0.5 mm thick wire for thick-walled pipes and profiles and great deburring results. Stainless steel version

Wire thickness  
mm

Part number

0,2

6 99 02 009 00 0

£ List Price  
excl. VAT

386.50

0,35

6 99 02 010 00 0

337.34



**Eye protection**

Acrylic screen for protection against sparks

No. in pack  
pcs

Part number

3

3 90 00 000 00 4

£ List Price  
excl. VAT

47.85

**Accessories GRIT GXW**



**Grinding/cooling emulsion**

Concentrate, 10 l, mixing ratio 1:30, yields 300 l of ready-to-use cooling lubricant.

Part number  
6 99 02 100 00 0

£ List Price  
excl. VAT  
351.00

**Other GRIT GX accessories**



**Hose**

Flexible, for swarf extraction, 90 mm in diameter, 1 m long, steel, high level of heat resistance.

Part number  
3 90 00 000 00 2

£ List Price  
excl. VAT  
59.43



**Dust container**

For extinguishing sparks, metal lid for hose connection, plastic, handles on the sides, capacity approx. 20 l.

Part number  
6 99 02 000 00 0

£ List Price  
excl. VAT  
110.74



**Device for dust extract**

for connecting to industrial dust extractor.

Part number  
6 99 02 000 14 7

£ List Price  
excl. VAT  
475.00



**Accessories for GRIT GI 75 / GI 75 2H**



**Graphite pad**  
As sliding base for surface grinding.

No. in pack pcs	Part number	£ List Price excl. VAT
5	3 90 00 000 00 1	106.40

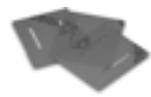

**Eye protection GU75/GR/GXR (3 pieces)**

Part number	£ List Price excl. VAT
3 90 00 000 00 7	78.86



**Mitre joint unit for preparation of welded seams**  
Fixture for chamfering workpieces to prepare welded seams.  
GI/GIS 75

Part number	£ List Price excl. VAT
6 99 02 000 15 0	254.00



**Stainless steel sanding support**  
GI/GIS 75

Part number	£ List Price excl. VAT
6 99 02 000 14 8	191.92

**Accessories for GRIT GI 150 / GI 150 2H**



**Graphite coating**

Part number	£ List Price excl. VAT
3 90 00 000 05 6	122.29



**Mitre joint unit for preparation of welded seams**  
Fixture for chamfering workpieces to prepare welded seams.  
GI/GIS 150

Part number	£ List Price excl. VAT
6 99 02 000 15 1	282.24



**Stainless steel sanding support**  
GI/GIS 150

Part number	£ List Price excl. VAT
6 99 02 000 14 9	220.14



**Eye protection**

No. in pack pcs	Part number	£ List Price excl. VAT
3	3 90 00 000 18 4	94.32

**Accessories for GRIT GIR**



**Contact roller**  
Long service lives, low roll resistance thanks to high-quality ball bearings, easy to interchange

Ø mm	Part number	£ List Price excl. VAT
20	6 99 02 101 00 0	163.64
22	6 99 02 102 00 0	178.00
25	6 99 02 103 00 0	178.00
25,4	6 99 02 104 00 0	178.00
26,9	6 99 02 105 00 0	163.64
28	6 99 02 106 00 0	163.64
30	6 99 02 107 00 0	178.00
32	6 99 02 108 00 0	178.00
33,7	6 99 02 109 00 0	178.00
35	6 99 02 110 00 0	163.64
38	6 99 02 111 00 0	178.00
38,1	6 99 02 112 00 0	178.00
38,3	6 99 02 113 00 0	163.64
40	6 99 02 114 00 0	163.64
42,4	6 99 02 115 00 0	178.00
44,5	6 99 02 116 00 0	178.00
48,3	6 99 02 117 00 0	178.00
50	6 99 02 118 00 0	178.00
50,8	6 99 02 119 00 0	204.00
60	6 99 02 120 00 0	204.00
60,3	6 99 02 121 00 0	204.00
63,5	6 99 02 122 00 0	204.00
69	6 99 02 123 00 0	186.76
76,1	6 99 02 124 00 0	279.00
76,2	6 99 02 125 00 0	279.00
84	6 99 02 126 00 0	256.17
88,9	6 99 02 127 00 0	256.17
101,6	6 99 02 128 00 0	256.17
104	6 99 02 129 00 0	350.39
108	6 99 02 130 00 0	350.39
114,3	6 99 02 131 00 0	382.00
133	6 99 02 132 00 0	773.46
139,7	6 99 02 133 00 0	773.46
168,3	6 99 02 134 00 0	846.20
193,7	6 99 02 000 18 7	569.67



**Eye protection**

No. in pack pcs	Part number	£ List Price excl. VAT
3	3 90 00 000 18 4	94.32



**Mitre grinding plate GIG**  
For precision mitre joint grinding, easy assembly.

Part number	£ List Price excl. VAT
6 99 02 175 00 0	387.00



**Adaptor**  
For optimum extraction, for connection to the machine base  
GRIT GIBE with double extraction.

Part number	£ List Price excl. VAT
6 99 02 182 00 0	187.00

**Accessories for GRIT GIE**



**Steel wire brush**

Ø 250 mm x 60 mm, with very high wire drawing strength for highly efficient use, mounting hole Ø 51 mm. 0.2 mm thick wire for thin-walled pipes and profiles. 0.35 mm-thick wire for universal use. 0.5 mm thick wire for thick-walled pipes and profiles and great deburring results.  
Steel version

Wire thickness mm	Part number	£ List Price excl. VAT
0,2	6 99 02 006 00 0	218.66
0,35	6 99 02 007 00 0	200.00
0,5	6 99 02 008 00 0	200.00



**Steel wire brush**

Ø 250 mm x 60 mm, with very high wire drawing strength for highly efficient use, mounting hole Ø 51 mm. 0.2 mm thick wire for thin-walled pipes and profiles. 0.35 mm-thick wire for universal use. 0.5 mm thick wire for thick-walled pipes and profiles and great deburring results.  
Stainless steel version

Wire thickness mm	Part number	£ List Price excl. VAT
0,2	6 99 02 009 00 0	386.50
0,35	6 99 02 010 00 0	337.34

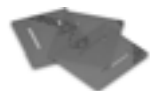

**Eye protection GUT5/GR/GXR (3 pieces)**

Part number	£ List Price excl. VAT
3 90 00 000 00 7	78.86



**Cassette filter**

Suitable for GRIT GIBE.

Part number	£ List Price excl. VAT
3 90 00 000 97 6	162.59



**Metal filter**

Suitable for GRIT GIBE.

Part number	£ List Price excl. VAT
3 90 00 000 10 0	127.54

**GRIT GIC accessories**



**Pipe support**

Ø 10-160 mm  
Can be combined with one another depending on the pipe length desired.

max. pipe length mm	Part number	£ List Price excl. VAT
1 000	6 99 02 180 60 0	475.00



**Pipe support**

Ø 10-160 mm  
Can be combined with one another depending on the pipe length desired.

max. pipe length mm	Part number	£ List Price excl. VAT
1 500	6 99 02 181 60 0	1,188.00



**Pipe cleaning unit**

For a clean and dry working environment. The coolant is wiped off the pipe surface without the pipe being scratched. For pipes with a diameter of between 10 and 130 mm. Easy to fit on GIC.

Part number	£ List Price excl. VAT
6 99 02 000 14 6	328.23



**Guide rail, brass**

For dry grinding and coarse material surfaces

Part number	£ List Price excl. VAT
3 90 00 000 49 6	51.88



**Nylon glide support**

For high surface quality

Part number	£ List Price excl. VAT
3 90 00 000 49 7	57.86



**Grinding/cooling emulsion**

Concentrate, 10 l, mixing ratio 1:30, yields 300 l of ready-to-use cooling lubricant.

Part number	£ List Price excl. VAT
6 99 02 100 00 0	351.00

**Other accessories GRIT GI**



**Hose**

Flexible, for swarf extraction, 90 mm in diameter, 1 m long, steel, high level of heat resistance.

Part number	£ List Price excl. VAT
3 90 00 000 00 2	59.43



**Dust container**

Plastic, to douse sparks, with handles on the sides, capacity about 15 l

Part number	£ List Price excl. VAT
3 90 00 000 38 5	POA



**Dust container**

For extinguishing sparks, metal lid for hose connection, plastic, handles on the sides, capacity approx. 20 l.

Part number	£ List Price excl. VAT
6 99 02 000 00 0	110.74



**Device for dust extract**

for connecting to industrial dust extractor.

Part number	£ List Price excl. VAT
6 99 02 000 14 7	475.00





**Contact disc**  
Ø 200 x 50 mm  
90 shore, grooved

Part number	£ List Price excl. VAT
6 99 02 346 00 0	358.00

**Drive wheel puller**

Part number	£ List Price excl. VAT
6 99 02 410 00 0	88.92



**Swivel joint GIT for GIL**  
For adapting working area to tight spaces, continuously variable  
swivel range of up to 90°.

Part number	£ List Price excl. VAT
6 99 02 176 00 0	320.10

**Plugbox 2 x 7 poles**

Part number	£ List Price excl. VAT
6 99 02 183 00 0	141.06



**Connecting piece**  
Required for adapting the GXR module to a belt grinder of the  
GI program

Part number	£ List Price excl. VAT
6 99 02 186 00 0	90.88



**Connecting piece**  
Required for adapting the GXC module to a belt grinder of the  
GI program

Part number	£ List Price excl. VAT
6 99 02 187 00 0	114.00

**Jawset vice**

Part number	£ List Price excl. VAT
6 99 02 335 00 0	305.19

**GRIT GI 100 accessories****Graphite coating**

Part number	£ List Price excl. VAT
3 90 00 000 18 3	53.46





## Practical, useful and sometimes essential: the FEIN tailored accessory.

With over 150 years of experience in building power tools, we know what really matters for the most diverse applications and in every industry. This also explains why so much is included in the the basic models of FEIN power tools and why some things are only available as optional accessories. Because what seems indispensable to one person might be superfluous to another. We know that from experience.



---

### Balancers

Page 210

Balancers increase operating comfort and safety. For loads of 0.5 kg - 60 kg.



		Balancer up to 1,5 kg	Balancer up to 1,5 kg	Balancer up to 2,5 kg	Balancer up to 2,5 kg	Balancer up to 3 kg	Balancer up to 5 kg	Balancer up to 6,5 kg
Safe suspension of device and power line in "weightless" state.								
<b>EAN 4014586...</b>		... 835075	... 854052	... 835099	... 835228	... 835105	... 835136	... 835143
<b>Page</b>		212	212	212	212	212	212	213
<b>Technical features</b>	Variable load	0,5 - 1,5 kg	0,5 - 1,5 kg	1,5 - 2,5 kg	1,5 - 2,5 kg	1 - 3 kg	2,5 - 5 kg	3,5 - 6,5 kg
	Factory setting	1 kg	1 kg	2 kg	2 kg	2 kg	3,5 kg	5 kg
	max. stroke	0,9 m	0,9 m	0,9 m	0,9 m	2 m	2 m	2 m
	Model	Stable nylon cable	Wire cable	Stable nylon cable	Wire cable	Wire cable	Wire cable	Wire cable
	Weight	0,35 kg	0,35 kg	0,35 kg	0,35 kg	3,2 kg	3,2 kg	3,2 kg



	Balancer up to 9 kg	Balancer up to 11 kg	Balancer up to 14 kg	Balancer up to 17 kg	Balancer up to 25 kg	Balancer up to 32 kg	Balancer up to 45 kg	Balancer up to 60 kg
	... 835150	... 835167	... 835174	.. 835181	... 880693	... 880709	... 880716	... 880723
	213	213	213	213	214	214	214	214
	4,5 - 9 kg	7,5 - 11 kg	10 - 14 kg	13,5 - 17 kg	13 - 25 kg	22 - 32 kg	30 - 45 kg	45 - 60 kg
	7 kg	9 kg	12 kg	15 kg	15 kg	25 kg	40 kg	50 kg
	2 m	2 m	2 m	2 m	1,9 m	1,9 m	1,9 m	1,9 m
	Wire cable	Wire cable	Wire cable	Wire cable	Wire cable	Wire cable	Wire cable	Wire cable
	3,2 kg	3,2 kg	3,2 kg	3,2 kg	11,2 kg	11,5 kg	12 kg	12,4 kg



Type	Part number	EAN	PC	£ List Price excl. VAT
<b>Balancer up to 1.5 kg</b>	<b>9 08 01 012 00 8</b>	<b>4014586835075</b>	<b>01</b>	<b>87.00</b>

For accessories, see page 214



Type	Part number	EAN	PC	£ List Price excl. VAT
<b>Balancer up to 1.5 kg</b>	<b>9 08 01 052 00 4</b>	<b>4014586834052</b>	<b>01</b>	<b>100.00</b>

For accessories, see page 214



Type	Part number	EAN	PC	£ List Price excl. VAT
<b>Balancer up to 2,5 kg</b>	<b>9 08 01 023 00 1</b>	<b>4014586835099</b>	<b>01</b>	<b>100.00</b>

For accessories, see page 214



Type	Part number	EAN	PC	£ List Price excl. VAT
<b>Balancer up to 2,5 kg</b>	<b>9 08 01 037 00 9</b>	<b>4014586835228</b>	<b>01</b>	<b>106.00</b>

For accessories, see page 214



Type	Part number	EAN	PC	£ List Price excl. VAT
<b>Balancer up to 3 kg</b>	<b>9 08 01 024 00 9</b>	<b>4014586835105</b>	<b>01</b>	<b>224.00</b>

For accessories, see page 214



Type	Part number	EAN	PC	£ List Price excl. VAT
<b>Balancer up to 5 kg</b>	<b>9 08 01 025 00 3</b>	<b>4014586835136</b>	<b>01</b>	<b>235.00</b>

For accessories, see page 214



Type	Part number	EAN	PC	£ List Price excl. VAT
<b>Balancer up to 6,5 kg</b>	<b>9 08 01 026 00 6</b>	<b>4014586835143</b>	<b>01</b>	<b>256.00</b>

For accessories, see page 214



Type	Part number	EAN	PC	£ List Price excl. VAT
<b>Balancer up to 9 kg</b>	<b>9 08 01 027 00 0</b>	<b>4014586835150</b>	<b>01</b>	<b>273.00</b>

For accessories, see page 214



Type	Part number	EAN	PC	£ List Price excl. VAT
<b>Balancer up to 11 kg</b>	<b>9 08 01 028 00 8</b>	<b>4014586835167</b>	<b>01</b>	<b>286.00</b>

For accessories, see page 214



Type	Part number	EAN	PC	£ List Price excl. VAT
<b>Balancer up to 14 kg</b>	<b>9 08 01 029 00 2</b>	<b>4014586835174</b>	<b>01</b>	<b>298.00</b>

For accessories, see page 214



Type	Part number	EAN	PC	£ List Price excl. VAT
<b>Balancer up to 17 kg</b>	<b>9 08 01 030 00 4</b>	<b>4014586835181</b>	<b>01</b>	<b>308.00</b>

For accessories, see page 214



Type	Part number	EAN	PC	£ List Price excl. VAT
<b>Balancer up to 25 kg</b>	<b>9 08 01 055 00 0</b>	<b>4014586880693</b>	<b>01</b>	<b>850.00</b>

For accessories, see page 214



Type	Part number	EAN	PC	£ List Price excl. VAT
<b>Balancer up to 32 kg</b>	<b>9 08 01 056 00 0</b>	<b>4014586880709</b>	<b>01</b>	<b>950.00</b>

For accessories, see page 214



Type	Part number	EAN	PC	£ List Price excl. VAT
<b>Balancer up to 45 kg</b>	<b>9 08 01 057 00 0</b>	<b>4014586880716</b>	<b>01</b>	<b>1,150.00</b>

For accessories, see page 214



Type	Part number	EAN	PC	£ List Price excl. VAT
<b>Balancer up to 60 kg</b>	<b>9 08 01 058 00 0</b>	<b>4014586880723</b>	<b>01</b>	<b>1,400.00</b>

For accessories, see page 214

## Balancers

### General accessories



**Spiral cordset**  
for electric tools with mains connection cables of quality  
HO 5 RN-F 2 x 1.

Part number  
3 07 07 157 03 5

£ List Price  
excl. VAT  
POA

### Balancer up to 60 kg



**Locking device**  
for locking the extended cable. eases the exchange of the  
hooked on tool.

Part number  
3 02 40 239 01 4

£ List Price  
excl. VAT  
74.99



**Swivel hook**  
to hook on the rope eye. Prevents the rope from twisting.

Part number  
3 02 32 044 01 0

£ List Price  
excl. VAT  
141.49





Part number	EAN	Description	£ List Price excl. VAT	PC	Page
7 105 01 62 00 0	4014586881744	ABOP 6 Select	304.00	01	6
7 105 02 62 00 0	4014586881751	ABOP 10 Select	304.00	01	6
7 105 03 62 00 0	4014586881768	ABOP 13-2 Select	363.00	01	6
7 105 04 62 00 0	4014586881775	AWBP 10 Select	375.00	01	11
7 109 01 62 00 0	4014586885537	AGWP 10 Select	470.00	01	16
7 112 28 00 95 0	4014586876238	ASM 14-6	POA	05	31
7 112 50 00 95 0	4014586874210	ASW 14-6 PC	POA	05	34
7 112 52 00 95 0	4014586874234	ASW 14-14 PC	POA	05	34
7 112 54 00 95 0	4014586874241	ASM 14-6 PC	POA	05	31
7 112 55 00 95 0	4014586874258	ASM 14-9 PC	POA	05	31
7 112 56 00 95 0	4014586874265	ASM 14-12 PC	POA	05	31
7 112 57 00 95 0	4014586877198	ASM 14-12	POA	05	31
7 112 59 00 95 0	4014586877211	ASM 14-9	POA	05	31
7 112 60 00 95 0	4014586881294	ASM 14-2	POA	05	31
7 112 61 00 95 0	4014586881317	ASM 14-2 PC	POA	05	31
7 112 62 60 00 0	4014586883830	ASW 18-30 PC	POA	05	34
7 112 63 60 00 0	4014586883847	ASW 18-45 PC	POA	05	35
7 112 64 60 00 0	4014586883854	ASW 18-60 PC	POA	05	35
7 112 65 60 00 0	4014586887906	ASW 18-6	POA	05	34
7 112 66 60 00 0	4014586887920	ASW 18-6 PC	POA	05	34
7 112 67 60 00 0	4014586887944	ASW 18-12	POA	05	34
7 112 68 60 00 0	4014586887968	ASW 18-12 PC	POA	05	34
7 112 69 60 00 0	4014586887982	ASW 18-18	POA	05	34
7 112 70 60 00 0	4014586888002	ASW 18-18 PC	POA	05	34
7 113 11 63 00 0	4014586881461	ASCS 6.3 Select	304.00	01	38
7 113 16 64 00 0	4014586887555	ASCT 18 M Select	408.00	01	40
7 113 16 65 00 0	4014586887562	ASCT 18 Select	297.00	01	40
7 113 20 61 24 0	4014586881515	ABSU 12 C	204.00	18	23
7 113 20 64 00 0	4014586885568	ABSU 12 Select	95.00	18	23
7 113 21 61 24 0	4014586881867	ABSU 12 W4C	204.00	18	24
7 113 21 64 00 0	4014586885575	ABSU 12 W4 Select	90.00	18	24
7 113 22 62 24 0	4014586887180	ABS 18 QC	450.00	18	22
7 113 22 63 00 0	4014586887197	Professional set for ABS 18 QC tapping	566.00	18	22
7 113 22 64 00 0	4014586887203	ABS 18 Q Select	253.00	18	22
7 113 23 62 24 0	4014586887241	ASB 18 QC	474.00	18	22
7 113 23 63 00 0	4014586887258	Professional set for ASB 18 QC tapping	590.00	18	23
7 113 23 64 00 0	4014586887265	ASB 18 Q Select	276.00	18	23
7 115 03 61 24 0	4014586881935	ASCD 12-100 W4C	257.00	18	29
7 115 03 64 00 0	4014586885582	ASCD 12-100 W4 Select	149.00	18	29
7 115 04 61 24 0	4014586887470	ASCD 12-150 W8C	312.00	18	28
7 115 04 64 00 0	4014586887388	ASCD 12-150 W8 Select	193.00	18	28
7 115 05 61 24 0	4014586887494	ASCD 12-150 W4C	301.00	18	28
7 115 05 64 00 0	4014586887401	ASCD 12-150 W4 Select	182.00	18	28
7 115 06 61 24 0	4014586887517	ASCD 18-300 W2	567.00	18	28
7 115 06 64 00 0	4014586887425	ASCD 18-300 W2 Select	299.00	18	28
7 115 07 61 24 0	4014586887531	ASCD 18-200 W4	556.00	18	28
7 115 07 64 00 0	4014586887449	ASCD 18-200 W4 Select	287.00	18	28
7 116 10 61 24 0	4014586882390	ASCM 12 QC	306.00	18	23
7 116 10 62 00 0	4014586886961	Professional set for ASCM 12 QC tapping	421.00	18	23
7 116 10 64 00 0	4014586885698	ASCM 12 Q Select	196.00	18	23
7 116 11 61 24 0	4014586887326	ASCM 18 QM	567.00	18	22
7 116 11 63 00 0	4014586887333	Professional set for ASCM 18 QM tapping	683.00	18	22
7 116 11 64 00 0	4014586887340	ASCM 18 QM Select	299.00	18	22
7 120 01 61 24 0	4014586888392	CCG 18-115 BL	633.00	01	45
7 120 01 62 00 0	4014586888408	CCG 18-115 BL Select	351.00	01	45
7 120 02 61 24 0	4014586888453	CCG 18-125 BL	633.00	01	45
7 120 02 62 00 0	4014586888460	CCG 18-125 BL Select	351.00	01	45
7 120 03 61 24 0	4014586888507	CCG 18-115 BLPD	633.00	01	45
7 120 03 62 00 0	4014586888514	CCG 18-115 BLPD Select	351.00	01	45
7 120 04 61 24 0	4014586888569	CCG 18-125 BLPD	633.00	01	45
7 120 04 62 00 0	4014586888576	CCG 18-125 BLPD Select	351.00	01	45
7 123 01 61 24 0	4014586888620	AGSZ 18-280 BL	556.00	01	58
7 123 01 62 00 0	4014586888637	AGSZ 18-280 BL Select	277.00	01	58
7 123 02 61 24 0	4014586888682	AGSZ 18-280 LBL	580.00	01	58
7 123 02 62 00 0	4014586888699	AGSZ 18-280 LBL Select	300.00	01	58
7 123 03 61 24 0	4014586888743	AGSZ 18-90 LBL	603.00	01	58
7 123 03 62 00 0	4014586888750	AGSZ 18-90 LBL Select	323.00	01	58
7 129 18 61 00 0	4014586884004	FEIN cordless SUPERCUT AFSC 1.7 Q Auto Glass	737.00	03	177
7 129 18 62 00 0	4014586885186	FEIN cordless SUPERCUT AFSC 1.7 QC	509.00	03	177
7 129 18 63 00 0	4014586885209	FEIN cordless SUPERCUT AFSC 1.7 Q	600.00	03	177
7 129 22 61 24 0	4014586884097	FEIN cordless MULTIMASTER AFMM 18 QSL	408.00	03	152
7 129 22 62 00 0	4014586885704	FEIN cordless MULTIMASTER AFMM 18 QSL Select	211.00	03	152
7 129 25 61 24 0	4014586884172	FEIN cordless MULTITALENT AFMT 12 QSL QuickStart	287.00	03	152
7 129 25 62 00 0	4014586885711	FEIN cordless MULTITALENT AFMT 12 QSL Select	178.00	03	152
7 129 26 61 24 0	4014586884257	FEIN cordless MULTITALENT AFMT 12 SL Start	264.00	03	152
7 129 27 60 00 0	4014586884295	FEIN cordless SUPERCUT AFSC 18 QSL Select	292.00	03	156
7 129 27 61 24 0	4014586884332	FEIN cordless SUPERCUT AFSC 18 QSL	560.00	03	156
7 129 27 62 24 0	4014586884370	FEIN cordless SUPERCUT AFSC 18 QCSL	509.00	03	156
7 129 27 64 24 0	4014586884400	FEIN cordless SUPERCUT AFSC 18 QSL for interior work with wood	726.00	03	156
7 129 27 66 00 0	4014586884424	FEIN cordless SUPERCUT AFSC 18 QSL for repairing/replacing windows	726.00	03	156

Part number	EAN	Description	£ List Price excl. VAT	PC	Page
7 129 27 67 00 0	4014586884431	FEIN cordless SUPERCUT AFSC 18 QSL for tile restoration/bathroom renovation	726.00	03	156
7 129 27 68 00 0	4014586884448	FEIN cordless SUPERCUT AFSC 18 QSL for heating/sanitary installation	726.00	03	156
7 130 03 61 00 0	4014586886640	ABSS 18 1.6 E Select	598.00	01	73
7 130 04 61 00 0	4014586886664	ABLS 18 1.6 E Select	539.00	01	76
7 132 04 61 00 0	4014586886688	ABLK 18 1.6 E Select	539.00	01	80
7 132 05 61 00 0	4014586886701	ABLK 18 1.3 CSE Select	539.00	01	80
7 132 06 61 00 0	4014586886725	ABLK 18 1.3 TE Select	539.00	01	80
7 170 02 61 24 0	4014586888200	AKBU 35 PMQW	1,849.00	01	110
7 170 02 62 00 0	4014586889122	AKBU 35 PMQW Select	1,590.00	01	110
7 202 06 00 22 9	4014586802749	DDSk 672*	1,976.00	01	8
7 202 09 00 22 7	4014586802855	DSke 672*	1,672.00	01	7
7 205 01 00 22 8	4014586804453	DDSk 672-1	2,042.00	01	8
7 205 03 00 22 0	4014586804569	ASq 672-1*	2,305.00	01	8
7 205 47 60 00 0	4014586874463	BOS 16*	575.00	01	7
7 205 49 60 00 0	4014586876443	BOS 16-2*	665.00	01	7
7 205 51 60 00 0	4014586878843	WBP 10*	447.00	01	11
7 205 52 60		BOP 6	358.00	01	6
7 205 52 61		BOP 6	391.00	01	6
7 205 53 60		BOP 10	358.00	01	6
7 205 53 61		BOP 10	391.00	01	6
7 205 54 60		BOP 10-2	436.00	01	7
7 205 54 61		BOP 10-2	454.00	01	7
7 205 55 60		BOP 13-2	458.00	01	7
7 205 55 61		BOP 13-2	489.00	01	7
7 209 38 60 00 0	4014586881256	GWP 10	794.00	01	16
7 213 04		SCS 4.8-25	419.00	01	38
7 213 06 50		SCT 5-40 M	399.00	01	40
7 213 13		SCT 5-40 X	327.00	01	40
7 220 78		MSf 636-1	759.00	01	134
7 221 05 00 23 7	4014586851242	WSB 20-180*	445.00	01	54
7 221 06 00 23 0	4014586851259	WSB 20-230*	445.00	01	54
7 221 07		WSG 20-180	383.00	01	54
7 221 08 24		WSG 20-230	383.00	01	54
7 221 10 00 23 3	4014586853116	WSB 25-180 X*	549.00	01	54
7 221 11 00 23 2	4014586853123	WSB 25-230 X*	549.00	01	54
7 221 13 50 01 4	4014586853819	RS 12-70 E*	1,439.00	01	134
7 221 13 51		RS 12-70 E – Professional stainless steel set	1,767.00	01	134
7 221 26		WSG 25-180	491.00	01	54
7 221 27		WSG 25-230	471.00	01	54
7 221 31 00 23 0	4014586858371	MSfv 649-1*	899.00	01	48
7 221 48 00 23 0	4014586862699	WPO 14-15 E	555.00	01	144
7 221 48 50 01 0	4014586862712	WPO 14-15 E marine polishing set	646.00	01	144
7 221 48 51 01 0	4014586867069	WPO 14-15 E Set	572.00	01	144
7 221 48 60 00 0	4014586872216	WPO 14-15 E marine polishing set	525.00	01	144
7 221 49 24		WPO 14-25 E	546.00	01	134
7 221 49 50		WPO 14-25 E – Stainless steel start set	961.00	01	134
7 221 49 51		WPO 14-25 E	572.00	01	144
7 221 63 24		WPO 10-25 E	499.00	01	144
7 221 63 51		WPO 10-25 E Set	515.00	01	144
7 221 65 5		ROT 14-200 E	754.00	01	134
7 221 66 60		RS 10-70 E Start set	1,412.00	01	134
7 221 67 60 00 0	4014586868936	KS 10-38 E set*	984.00	01	134
7 221 73 60		WSG 8-115	131.00	19	48
7 221 74 60		WSG 8-125	129.00	19	48
7 221 75 60		WSG 12-125 P	194.00	19	48
7 221 76 60		WSG 12-125 PQ	205.00	19	48
7 221 77 60		WSG 11-125	156.00	19	48
7 221 87 60		WSG 11-125 RT	195.00	19	48
7 221 91 60		WSG 15-125 PRT	260.00	19	49
7 222 07 60		WSG 17-125 P	235.00	19	49
7 222 08 60		WSG 17-125 PQ	248.00	19	49
7 222 09 60		WSG 17-125 PS	235.00	19	49
7 222 10 60		WSG 17-125 PSQ	267.00	19	49
7 222 11 60		WSG 17-150 P	235.00	19	49
7 222 12 60		WSG 17-150 PQ	248.00	19	49
7 222 13 60		WSG 17-70 Inox	337.00	19	50
7 222 13 61		WSG 17-70 Inox Start set	POA	19	135
7 222 18 60		WSG 17-125 PR	273.00	19	50
7 222 19 60		WSG 17-125 PRT	273.00	19	50
7 222 20 60		WSG 17-150 PR	273.00	19	50
7 222 21 60		WSG 17-150 PRT	POA	19	50
7 222 22 60 00 0	4014586883731	WSG 17-70 Inox R	376.00	19	50
7 222 23 60		WSG 17-70 Inox RT	POA	19	50
7 223 16 60		GSZ 8-280 P	267.00	01	59
7 223 17 60		GSZ 8-280 PE	295.00	01	59
7 223 18 60		GSZ 8-280 PL	481.00	01	59
7 223 19 60		GSZ 8-280 PEL	508.00	01	59
7 223 20 60		GSZ 8-90 PEL	602.00	01	60
7 223 21 60		GSZ 11-320 PRL	529.00	01	60
7 223 22 60		GSZ 11-320 PERL	548.00	01	60



Part number	EAN	Description	£ List Price excl. VAT	PC	Page
7 223 23 60		GSZ 11-90 PERL	642.00	01	60
7 223 24 60		GSZ 4-280 EL*	470.00	01	59
7 223 25 60		GSZ 4-90 EL*	470.00	01	59
7 228 05 50		BF 10-280 E	685.00	01	135
7 228 05 51		BF 10-280 E Start set	808.00	01	135
7 229 46 61		FEIN SUPERCUT FSC 500 QSL	502.00	03	157
7 229 46 62		FEIN SUPERCUT FSC 500 QSL for interior work with wood	625.00	03	157
7 229 46 64		FEIN SUPERCUT FSC 500 QSL for tile restoration/bathroom renovation	625.00	03	157
7 229 46 65 00 0	4014586885407	FEIN SUPERCUT FSC 500 QSL for heating/sanitary installation	625.00	03	157
7 229 46 67 00 0	4014586885414	FEIN SUPERCUT FSC 500 QSL Composite	663.00	03	157
7 229 52 61		FEIN MULTIMASTER FMM 350 QSL Top	351.00	03	152
7 229 52 62		FEIN MULTIMASTER FMM 350 QSL QuickStart	293.00	03	152
7 229 52 66		FEIN MULTIMASTER FMM 350 QSL Marine	385.00	03	153
7 229 53 61		FEIN MULTITALENT FMT 250 QSL QuickStart	238.00	03	153
7 229 54 61		FEIN MULTITALENT FMT 250 SL Start	180.00	03	153
7 230 23 00		BLS 3.5	1,846.00	01	76
7 230 24		BLS 4.2	1,916.00	01	76
7 230 31 61		BSS 1.6 E	732.00	01	73
7 230 32 61		BSS 1.6 CE	815.00	01	73
7 230 33 61		BSS 2.0 E	925.00	01	73
7 230 34 61		BLS 1.6 E	682.00	01	76
7 230 35 61		BLS 2.5 E	1,047.00	01	76
7 232 30 00		BLK 3.5	1,937.00	01	81
7 232 31 00		BLK 5.0	2,941.00	01	81
7 232 38 60		BLK 1.6 E	659.00	01	80
7 232 39 60		BLK 1.6 LE	1,029.00	01	80
7 232 40 60		BLK 2.0 E	915.00	01	81
7 232 41 60		BLK 1.3 TE	711.00	01	80
7 232 42 60		BLK 1.3 CSE	711.00	01	81
7 234 15		AStE 638	645.00	01	87
7 234 17		ASt 638	549.00	01	87
7 234 22 00 23 0	4014586858470	AStx 649-1*	2,399.00	01	90
7 234 23		AStxe 649-1	2,548.00	01	90
7 236 31 50		FEIN SUPERCUT FSC 1.6	645.00	03	177
7 236 42 56 01 0	4014586862859	FEIN SUPERCUT FSC 1.6 Q Auto Glass	694.00	03	177
7 238 14 00 23 0	4014586865744	MF 14-180*	1,409.00	01	93
7 270 32		KBM 80 auto	4,375.00	01	122
7 270 34		KBM 80 U	3,786.00	01	111
7 270 40 61		KBM 50 U	2,061.00	01	111
7 270 41 61		KBM 50 Q	1,785.00	01	111
7 270 42 61		KBM 50 auto	2,587.00	01	122
7 270 43 61		KBM 65 U	2,511.00	01	111
7 270 54 61		KBU 35 QW	1,342.00	01	110
7 270 56 61		KBU 35 MQW	1,537.00	01	110
7 270 58 61		KBU 35-2 QW	1,698.00	01	110
7 271 03 61		KBH 25-2 U	847.00	01	97
7 271 04 61		KBH 25 S	799.00	01	97
7 272 01 61		KBB 30	920.00	01	101
7 272 02 61		KBB 38	1,071.00	01	101
7 272 03 61		KBB 40	1,434.00	01	103
7 272 04 61		KBB 60	2,083.00	01	101
7 272 15 61		KBC 35	1,299.00	01	103
7 534 08 00 00 0	4014586855639	STS 325 R	3,126.00	01	90
7 536 03 00 01 0	4014586861906	FEIN SUPERCUT MOtlx 6-25	787.00	03	177
7 820 02 00 26 8	4014586823874	MSfov 852 300 Hz 200 V	1,499.00	09	-
7 820 43 00 26 5	4014586826646	MSfo 869d 300 Hz 200 V	1,349.00	09	-
7 820 62 00 22 0	4014586856742	MSfo 869-1c 300 Hz 72 V	1,349.00	09	-
7 820 62 00 26 0	4014586856759	MSfo 869-1c 300 Hz 200 V	1,349.00	09	64
7 820 63 00 12 0	4014586856797	MSfo 869-1c 200 Hz 72 V	1,349.00	09	-
7 820 63 00 17 0	4014586860190	MSfo 869-1c 200 Hz 135 V	1,349.00	09	-
7 820 63 00 20 0	4014586856803	MSfo 869-1c 200 Hz 265 V	1,349.00	09	-
7 820 64 00 12 0	4014586856810	MSfo 869-1d 200 Hz 72 V	1,349.00	09	-
7 820 64 00 17 0	4014586860206	MSfo 869-1d 200 Hz 135 V	1,349.00	09	-
7 820 64 00 20 0	4014586856827	MSfo 869-1d 200 Hz 265 V	1,349.00	09	-
7 820 65 00 22 0	4014586860664	MSfo 869-1d 300 Hz 72 V	1,349.00	09	-
7 820 65 00 26 0	4014586856834	MSfo 869-1d 300 Hz 200 V	1,349.00	09	64
7 820 70 00 20 0	4014586856926	MSfo 852-1c 200 Hz 265 V	1,187.00	09	-
7 820 71 00 26 0	4014586856933	MSfo 852-1c 300 Hz 200 V	1,186.00	09	64
7 820 72 00 20 0	4014586856964	MSfo 852-1d 200 Hz 265 V	1,153.00	09	-
7 820 73 00 26 0	4014586856971	MSfo 852-1d 300 Hz 200 V	1,175.00	09	64
7 820 74 00 12 0	4014586857008	MSfo 870-1c 200 Hz 72 V	1,556.00	09	-
7 820 74 00 17 0	4014586857015	MSfo 870-1c 200 Hz 135 V	1,560.00	09	-
7 820 74 00 20 0	4014586857022	MSfo 870-1c 200 Hz 265 V	1,556.00	09	-
7 820 75 00 26 0	4014586857053	MSfo 870-1c 300 Hz 200 V	1,560.00	09	64
7 820 76 00 20 0	4014586857091	MSfo 870-1d 200 Hz 265 V	1,556.00	09	-
7 820 77 00 26 0	4014586857107	MSfo 870-1d 300 Hz 200 V	1,556.00	09	64
7 820 79 00 20 0	4014586857138	MSfo 849-1c 200 Hz 265 V	1,187.00	09	-
7 820 80 00 26 0	4014586857145	MSfo 849-1c 300 Hz 200 V	1,188.00	09	64
7 820 81 00 17 0	4014586857268	MSf 843-1a 200 Hz 135 V	1,149.00	09	-
7 820 81 00 20 0	4014586857275	MSf 843-1a 200 Hz 265 V	1,153.00	09	-

Part number	EAN	Description	£ List Price excl. VAT	PC	Page
7 820 81 99 20 0	4014586857282	MSf 843-1a 200 Hz 265 V	1,187.00	09	-
7 820 82 00 12 0	4014586857299	MSfov 852-1 200 Hz 72 V	1,499.00	09	-
7 820 82 00 17 0	4014586857305	MSfov 852-1 200 Hz 135 V	1,499.00	09	-
7 820 82 00 20 0	4014586857312	MSfov 852-1 200 Hz 265 V	1,499.00	09	-
7 820 83 00 22 0	4014586857329	MSfov 852-1 300 Hz 72 V	1,499.00	09	-
7 820 83 00 26 0	4014586857336	MSfov 852-1 300 Hz 200 V	1,498.00	09	65
7 820 85 00 26 0	4014586864402	MSf 843-1c 300 Hz 200 V	1,088.00	09	65
7 820 86 60 00 0	4014586869513	HFw 9-125 300 Hz 200 V	858.00	09	65
7 820 87 60 00 0	4014586886022	MSfov 852-1-180 300 Hz 200 V	1,730.00	09	65
7 823 03 00 17 2	4014586827575	MSho 840-2 200 Hz 135 V	867.00	09	-
7 823 03 00 20 4	4014586827599	MSho 840-2 200 Hz 265 V	864.00	09	-
7 823 03 00 22 9	4014586827612	MSho 840-2 300 Hz 72 V	864.00	09	-
7 823 03 00 26 0	4014586827636	MSho 840-2 300 Hz 200 V	867.00	09	67
7 823 14 00 17 7	4014586828527	MShyo 840-1 200 Hz 135 V	949.00	09	-
7 823 19 00 20 0	4014586857923	MSh 843-1 200 Hz 265 V	1,037.00	09	-
7 823 19 00 22 0	4014586857930	MSh 843-1 300 Hz 72 V	1,037.00	09	-
7 823 19 00 26 0	4014586857947	MSh 843-1 300 Hz 200 V	1,037.00	09	67
7 823 20 00 12 0	4014586857978	MSho 849-1 Z 200 Hz 72 V	1,194.00	09	-
7 823 20 00 17 0	4014586857985	MSho 849-1z 200 Hz 135 V	1,195.00	09	-
7 823 20 00 20 0	4014586857992	MSho 849-1Z 200 Hz 265 V	1,194.00	09	-
7 823 20 00 22 0	4014586858005	MSho 849-1 Z 300 Hz 72 V	1,194.00	09	-
7 823 20 00 26 0	4014586858012	MSho 849-1 Z 300 Hz 200 V	1,195.00	09	67
7 823 22 00 26 0	4014586860015	MSho 852-1ZV 300 Hz 200 V	1,194.00	09	-
7 824 37 00 22 0	4014586858081	MShyo 869-1a 300 Hz 72 V	1,764.00	09	-
7 824 37 00 26 0	4014586857633	MShyo 869-1a 300 Hz 200 V	1,766.00	09	67
7 824 38 00 26 0	4014586858111	MShyo 869-1d 300 Hz 200 V	1,542.00	09	67
7 824 39 00 12 0	4014586858128	MShyo 852-3a 200 Hz 72 V	1,233.00	09	-
7 824 39 00 17 0	4014586871714	MShyo 852-3a 200 Hz 135 V	1,233.00	09	-
7 824 39 00 20 0	4014586857640	MShyo 852-3a 200 Hz 265 V	1,140.00	09	-
7 824 39 00 22 0	4014586858135	MShyo 852-3a 300 Hz 72 V	1,233.00	09	-
7 824 39 00 26 0	4014586857657	MShyo 852-3a 300 Hz 200 V	1,233.00	09	67
7 824 40 00 26 0	4014586858180	MShyo 852-4a 300 Hz 200 V	1,476.00	09	67
7 824 41 00 20 0	4014586858210	MSho 852-1 200 Hz 265 V	1,187.00	09	-
7 824 42 00 22 0	4014586858234	MSho 852-1 300 Hz 72 V	1,187.00	09	-
7 824 42 00 26 0	4014586858241	MSho 852-1 300 Hz 200 V	1,191.00	09	67
7 901 05 00 40 3	4014586857879	GRIT GXE	915.00	13	191
7 901 21 00 40 3	4014586871844	GX 75	1,057.00	13	-
7 901 22 00 40 3	4014586871882	GRIT GX 75 2H	1,298.00	13	-
7 901 23 00 44 3	4014586871936	GRIT GXC	1,412.00	13	191
7 901 24 00 44 3	4014586873145	GRIT GXW	778.00	13	191
7 901 31 00 40 3	4014586872018	GRIT GX 75	1,234.00	13	189
7 901 32 00 40 3	4014586872063	GRIT GX 75 2H	1,473.00	13	189
7 902 01 00 40 3	4014586858913	GRIT GI 75	1,884.00	13	193
7 902 02 00 40 3	4014586858944	GRIT GI 75 2H	2,261.00	13	193
7 902 04 00 40 3	4014586858999	GRIT GI 150	2,277.00	13	193
7 902 05 00 40 3	4014586859019	GRIT GI 150 2H	2,657.00	13	193
7 902 07 00 40 3	4014586859057	GRIT GIE	1,797.00	13	196
7 902 12 00 44 3	4014586867656	GRIT GIC	3,067.00	13	196
7 902 13 00 40 3	4014586872599	GRIT GIMS 75	3,555.00	13	196
7 902 14 00 40 3	4014586872643	GRIT GIMS 150	4,004.00	13	196
7 902 16 00 40 3	4014586878614	GIMS 75 2H	4,317.00	13	196
7 902 17 00 40 3	4014586878621	GIMS 150 2H	4,606.00	13	196
7 902 18 00 40 3	4014586878645	GIMS 75-6	4,317.00	13	196
7 902 19 00 40 3	4014586878683	GIMS 150-6	4,606.00	13	197
7 902 23 00 23 2	4014586887043	GRIT GI 100 EF	1,394.00	13	193
7 902 23 00 40 3	4014586887067	GRIT GI 100	1,156.00	13	193
7 902 29 00 44 3	4014586878072	GRIT GIS 75	1,534.00	13	-
7 902 29 50 44 3	4014586878126	GRIT GIS 75	1,677.00	13	193
7 902 30 00 44 3	4014586878171	GIS 150	1,883.00	13	-
7 902 30 50 44 3	4014586878225	GRIT GIS 150	2,018.00	13	193
7 902 35 00 40 3	4014586880921	GRIT GILSGIB	6,511.00	13	197
7 902 48 00 40 3	4014586880945	GRIT GIL	3,136.00	13	197
7 902 51 00 40 3	4014586880976	GRIT GILS	8,068.00	13	197
7 903 01 00 23 2	4014586880426	GRIT GHB 15-50	828.00	01	185
7 903 02 00 23 2	4014586880457	GRIT GHB 15-50 Inox	908.00	01	185
7 905 01 00 40 3	4014586888255	GRIT GKS 75	1,306.00	13	200
7 905 02 00 23 2	4014586888262	GRIT GKS 75	1,097.00	13	200
7 905 02 00 40 3	4014586888279	GRIT GKS 75	888.00	13	200
7 905 03 00 40 3	4014586888293	GRIT GKS 75	993.00	13	200
7 905 04 00 40 3	4014586888309	GRIT GKS 75 2H	1,045.00	13	200
9 03 16 223 00 8	4014586847924	MBS 32 F*	3,276.00	01	13
9 03 20 223 00 0	4014586878515	IBS 16*	590.00	01	13
9 08 01 012 00 8	4014586835075	Balancer up to 1,5 kg	87.00	01	212
9 08 01 023 00 1	4014586835099	Balancer up to 2,5 kg	100.00	01	212
9 08 01 024 00 9	4014586835105	Balancer up to 3 kg	224.00	01	212
9 08 01 025 00 3	4014586835136	Balancer up to 5 kg	235.00	01	212
9 08 01 026 00 6	4014586835143	Balancer up to 6,5 kg	256.00	01	213
9 08 01 027 00 0	4014586835150	Balancer up to 9 kg	273.00	01	213
9 08 01 028 00 8	4014586835167	Balancer up to 11 kg	286.00	01	213
9 08 01 029 00 2	4014586835174	Balancer up to 14 kg	298.00	01	213



Part number	EAN	Description	£ List Price excl. VAT	PC	Page
9 08 01 030 00 4	4014586835181	Balancer up to 17 kg	308.00	01	213
9 08 01 037 00 9	4014586835228	Balancer up to 2,5 kg	106.00	01	212
9 08 01 052 00 4	4014586854052	Balancer up to 1.5 kg	100.00	01	212
9 08 01 055 00 0	4014586880693	Balancer up to 25 kg	850.00	01	214
9 08 01 056 00 0	4014586880709	Balancer up to 32 kg	950.00	01	214
9 08 01 057 00 0	4014586880716	Balancer up to 45 kg	1,150.00	01	214
9 08 01 058 00 0	4014586880723	Balancer up to 60 kg	1,400.00	01	214
9 20 27 060		Dustex 25 L set	POA	01	127
9 20 27 223		Dustex 25 L	345.00	01	127
9 20 28 060		Dustex 35 L set	POA	01	127
9 20 28 223		Dustex 35 L	393.00	01	127
9 20 30 060		Dustex 35 LX AC	726.00	01	127
9 20 32 060		Dustex 35 MX AC	909.00	01	127
9 90 01 001 00 1	4014586871974	GRIT GXR	1,366.00	13	191
9 90 01 002 00 0	4014586858340	GRIT GIXS	289.00	13	198
9 90 01 003 00 0	4014586859064	GRIT GIB	317.00	13	197
9 90 01 004 00 0	4014586859071	GRIT GIBE	1,805.00	13	197
9 90 01 007 00 1	4014586878263	GRIT GIR	2,714.00	13	198
9 90 01 009 00 0	4014586859125	GRIT GIXBE	1,906.00	13	198
9 90 01 010 00 1	4014586871417	GRIT GISBX	183.00	13	-
9 90 01 012 00 0	4014586880488	GRIT GHBD	278.00	01	186
9 90 01 012 01 0	4014586886992	GRIT GHBM	534.00	01	186
9 90 01 012 02 0	4014586887005	GRIT GHBR	669.00	01	186
9 90 01 012 03 0	4014586887548	GRIT GHBML	818.00	01	186
9 90 01 012 04 0	4014586888316	GRIT GHBK	679.00	01	186

Accessories in numerical order

Part number	EAN	Description	£ List Price excl, VAT	PC	Page
3 01 09 011 00 7	4014586008844	Die	155.27	02	-
3 01 09 106 00 9	4014586009230	Die	235.84	02	-
3 01 09 128 01 8	4014586198071	Adaptor ass.	12.55	04	-
3 01 09 141 00 3	4014586224060	Die	55.81	02	82
3 01 09 141 02 0	4014586318134	Die (2 ea)	88.79	02	82
3 01 09 141 03 0	4014586318141	Die (5 ea)	194.45	02	82
3 01 09 154 00 7	4014586246598	Die holder	220.92	02	82
3 01 09 169 00 9	4014586265056	Die	166.09	02	83
3 01 09 169 03 0	4014586275024	Die/punch set	209.90	02	83
3 01 09 169 04 0	4014586318158	Die (2 ea)	266.31	02	83
3 01 09 170 00 1	4014586265063	Die	188.76	02	83
3 01 09 170 03 0	4014586275031	Die/punch set	229.51	02	83
3 01 09 170 04 0	4014586318165	Die (2 ea)	300.08	02	83
3 01 09 203 00 0	4014586351230	Adaptor key	6.43	02	-
3 02 16 130 00 4	4014586010427	Bolt	0.52	02	-
3 02 17 332 00 9	4014586243672	Centring pin, short	15.74	02	118
3 02 17 333 00 3	4014586243689	Centring pin, long	15.74	02	106
3 02 17 337 00 2	4014586245225	Centring pin, thin	18.90	02	118
3 02 17 338 00 0	4014586251271	Centring pin, thin, short	14.02	02	118
3 02 17 355 00 0	4014586284552	Centering pin	18.90	02	118
3 02 17 358 00 0	4014586341941	Centering pins	15.28	02	106
3 02 17 359 00 0	4014586341958	Centering pins	15.28	02	106
3 02 29 216 00 5	4014586012155	Safety guard	5.96	02	142
3 02 29 347 01 0	4014586354330	Metal skewers	5.55	02	-
3 02 31 003 00 3	4014586012414	Chain clamps	56.47	02	-
3 02 31 008 00 0	4014586012421	Chain clamps	137.34	02	-
3 02 32 044 01 0	4014586232591	Swivel hook assy	141.49	02	214
3 02 40 239 01 4	4014586232584	Locking device	74.99	02	214
3 02 40 247 00 2	4014586253510	Bottle holder	17.13	02	-
3 02 40 308 01 0	4014586353111	Vacuum ring set	11.49	02	-
3 05 01 242 00 1	4014586014272	Sleeve	6.58	02	-
3 05 01 345 01 0	4014586272993	Colour-coded ring set, black	17.32	06	36
3 05 01 345 02 0	4014586273006	Coding-sleeve ass.	15.08	06	36
3 05 01 346 01 0	4014586273013	Colour-coded ring set, grey	17.32	06	36
3 05 01 347 01 0	4014586273020	Colour-coded ring set, green	17.32	06	36
3 05 01 348 01 0	4014586273037	Colour-coded ring set, blue	17.32	06	36
3 05 01 349 01 0	4014586273044	Colour-coded ring set, red	17.32	06	36
3 05 01 350 01 0	4014586273051	Colour-coded ring set, orange	17.32	06	36
3 05 01 351 01 0	4014586274898	Colour-coded ring set, yellow	17.32	06	36
3 05 01 352 01 0	4014586317106	Colour-coded ring set, black	17.32	06	36
3 05 01 352 02 0	4014586317113	Coding-sleeve ass.	14.39	06	36
3 05 01 353 01 0	4014586317120	Colour-coded ring set, grey	17.32	06	36
3 05 01 354 01 0	4014586317137	Colour-coded ring set, green	17.32	06	36
3 05 01 355 01 0	4014586317144	Colour-coded ring set, blue	17.32	06	36
3 05 01 356 01 0	4014586317151	Colour-coded ring set, red	17.32	06	36
3 05 01 357 01 0	4014586317168	Colour-coded ring set, orange	17.32	06	36
3 05 01 358 01 0	4014586317175	Colour-coded ring set, yellow	17.32	06	36
3 05 05 066 01 5	4014586235271	Sleeve ass.	33.95	02	-
3 05 05 068 01 7	4014586248769	Sleeve ass.	35.29	02	-
3 05 05 069 01 1	4014586258928	Sleeve ass.	22.76	02	-
3 05 17 028 00 7	4014586016931	Hose nozzle Ø32 mm	2.83	02	88
3 05 17 029 00 1	4014586016948	Hose nozzle Ø27 mm	3.45	02	88
3 06 05 109 00 6	4014586224503	adapter	1.31	02	-
3 06 05 110 00 8	4014586224510	adapter	1.31	02	-
3 06 05 114 01 1	4014586266848	Adapter FSC	25.37	04	175
3 07 06 268 00 6	4014586022260	Spiral cordset	80.63	02	-
3 07 28 123 00 7	4014586030104	Plug 3P+SK	25.65	02	68
3 07 28 124 00 5	4014586030111	Plug 3P+SK	34.78	02	68
3 07 28 130 00 0	4014586030173	BUILD-ON COUPLER	31.54	02	68
3 07 28 131 00 9	4014586030180	BUILD-ON COUPLER	40.72	02	68
3 07 28 137 00 5	4014586030241	Wall socket 3P+SK	35.48	02	69
3 07 28 138 00 3	4014586030258	Wall socket 3P+SK	47.13	02	69
3 07 28 141 00 8	4014586030289	Attachment socket 3P+SK EZ28-141	49.75	02	69
3 07 28 368 00 0	4014586296586	Adaptor GB, 230V	5.99	02	-
3 07 51 144 00 3	4014586032993	Motor safety switch 3P	95.56	02	-
3 07 56 004 00 6	4014586033266	Motor protect.switch	28.23	02	-
3 07 56 017 00 6	4014586033358	Motor protect.switch	26.64	02	-
3 07 56 084 00 8	4014586264189	Motor safety plug 1.0-1.6 A	196.77	02	-
3 07 56 085 00 2	4014586264196	Motor safety plug 1.6-2.5 A	197.64	02	68
3 07 56 086 00 5	4014586264202	Motor safety plug 2.5-4.0 A	197.64	02	-
3 07 56 087 00 9	4014586264219	Motor safety plug 4.0-6.3 A	197.64	02	68
3 07 56 088 00 7	4014586264226	Motor safety plug 6.3-9.0 A	222.13	02	68
3 07 56 089 00 1	4014586264233	Motor protection plug 9.0-12.5 A	222.13	02	68
3 07 56 090 00 3	4014586264240	Motor safety plug 12.5-16.0 A	222.13	02	68
3 07 56 093 00 9	4014586264271	Motor safety plug 1.6-2.5 A	204.91	02	68
3 07 56 094 00 7	4014586264288	Motor safety plug 2.5-4.0 A	204.91	02	-
3 07 56 095 00 1	4014586264295	Motor safety plug 4.0-6.3 A	204.91	02	68



Part number	EAN	Description	£ List Price excl, VAT	PC	Page
3 07 56 096 00 4	4014586264301	Motor safety plug 6.3-9.0 A	230.91	02	68
3 07 56 097 00 8	4014586264318	Motor protection plug 9.0-12.5 A	230.91	02	68
3 07 56 098 00 6	4014586264325	Motor safety plug 12.5-16.0 A	230.91	02	68
3 07 98 592 77 0	4014586622040	Cable	8.96	02	-
3 12 07 103 01 3	4014586044910	Eccentric head assy	121.76	06	139
3 13 08 072 00 0	4014586048123	1 pair of blades	30.95	02	77
3 13 08 092 00 8	4014586210803	Fixed blade	69.24	02	77
3 13 08 096 00 7	4014586210810	Plunger blade, 4.2 mm	116.07	02	77
3 13 08 098 00 9	4014586213477	Plunger blade, Cr	180.86	02	77
3 13 08 110 00 3	4014586229812	Blades	103.93	02	74
3 13 08 111 00 2	4014586229829	Blade pin	16.51	02	74
3 13 08 113 00 9	4014586229836	Threading dies (set)	110.80	02	74
3 13 08 123 00 8	4014586229867	Cutter blades, up to 2.0 mm	163.33	02	74
3 13 08 136 00 2	4014586229805	Blades	58.05	02	77
3 13 08 143 00 6	4014586230092	Blades	66.76	02	77
3 13 08 146 00 1	4014586232911	Blades	58.83	02	77
3 13 08 147 00 5	4014586232928	Blades	70.26	02	77
3 13 08 150 00 9	4014586239583	Cutter blade, straight, 1 - 1.6 mm	74.77	02	74
3 13 08 151 00 8	4014586239590	Curve blade, 1 mm	79.46	02	74
3 13 08 152 00 1	4014586239606	Blade Cr	88.19	02	74
3 13 08 153 01 4	4014586239613	Threading dies UBS 1.6	80.45	02	74
3 13 08 153 02 0	4014586239620	Threading dies UBS 1.6c	80.45	02	74
3 13 09 036 00 4	4014586048512	Punch	61.25	02	-
3 13 09 039 00 0	4014586048543	Supporting pin	113.02	02	-
3 13 09 040 00 2	4014586048550	Die	58.62	02	83
3 13 09 093 00 3	4014586199931	Die	67.36	02	83
3 13 09 094 00 1	4014586199948	Die	76.77	02	83
3 13 09 097 00 2	4014586199955	Punch	61.13	02	83
3 13 09 098 00 0	4014586199962	Punch	89.04	02	83
3 13 09 100 01 4	4014586199986	Spacer sleeve	104.03	02	-
3 13 09 107 00 0	4014586210742	Die, 5 mm	109.05	02	83
3 13 09 108 00 8	4014586210759	Die, 3 mm	109.05	02	83
3 13 09 109 00 2	4014586210766	P die, 5 mm	106.99	02	83
3 13 09 110 00 4	4014586210773	Punch	88.88	02	83
3 13 09 110 01 3	4014586259161	Punch and die set, 5 mm, steel	193.20	02	83
3 13 09 114 00 8	4014586210780	Chips bag	98.91	02	83
3 13 09 119 00 1	4014586209852	Punch	69.16	02	-
3 13 09 121 00 2	4014586209876	Wearing plate	12.76	02	82
3 13 09 122 00 5	4014586209883	Die	75.02	02	82
3 13 09 122 02 0	4014586318172	Die (2 ea)	135.24	02	82
3 13 09 122 03 0	4014586318189	Die (5 ea)	319.83	02	82
3 13 09 134 00 6	4014586259185	Punch, 3 mm, Cr	88.88	02	83
3 13 09 134 01 5	4014586259192	Punches and dies in a set	193.20	02	83
3 13 22 190 01 4	4014586053363	Filter bag, 5-pack	53.27	02	-
3 13 22 599 01 5	4014586227016	Filter bag, 5-pack	53.10	02	-
3 13 22 600 00 1	4014586227009	Filter element	59.61	02	-
3 13 22 601 01 9	4014586227030	Flat-fold filter	18.47	02	-
3 13 22 602 01 2	4014586227047	Paper filter 5/pack	25.26	02	-
3 13 22 757 01 6	4014586261386	Filter paper BIA, 5-pack	44.59	02	129
3 13 22 765 00 9	4014586261454	Filter cartridge	59.64	02	129
3 13 22 767 01 5	4014586261478	Suction hose assy	52.20	02	129
3 13 22 771 00 9	4014586261492	Connecting piece	5.59	02	129
3 13 22 772 00 2	4014586261508	Stepped collar	11.20	02	129
3 13 22 781 01 7	4014586262451	Paper filter, 5-pack Dustex 25	26.11	02	129
3 13 22 810 01 0	4014586307718	Paper filter, 5-pack Dustex 40	48.53	02	129
3 13 22 811 01 0	4014586307725	Dust bag BIA 5ea Dust40	96.98	02	129
3 13 27 064 00 8	4014586199580	Protective steel jaws	54.88	02	92
3 13 27 068 00 7	4014586199627	Retaining screw	24.83	02	-
3 13 29 100 01 6	4014586218571	Clamping piece, 2-pack	5.86	02	-
3 13 29 106 00 8	4014586218595	Sawing support	13.61	02	-
3 13 29 107 00 2	4014586218588	Sawing support for pipes	60.05	02	-
3 13 33 090 00 0	4014586368375	Drill chuck	33.67	02	-
3 13 33 118 00 0	4014586368382	Drill chuck	28.97	02	-
3 13 35 017 01 1	4014586262390	Rotating roller	77.48	02	136
3 13 45 012 01 0	4014586366197	Flat-fold filter	31.08	02	128
3 13 45 059 01 0	4014586366210	Flat-fold filter	59.64	02	128
3 13 45 060 01 0	4014586366227	Flat-fold filter	95.06	02	128
3 13 45 061 01 0	4014586366234	Fleece filter bag	24.87	02	129
3 13 45 062 01 0	4014586366241	Fleece filter bag	32.31	02	129
3 13 45 063 01 0	4014586366258	Disposal bag	33.53	02	129
3 13 45 064 01 0	4014586366265	Permanent filter	60.90	02	129
3 13 45 065 01 0	4014586366272	Suction hose	77.08	02	128
3 13 45 066 01 0	4014586366289	Suction hose	69.17	02	128
3 13 45 067 01 0	4014586366296	Extension hose	70.85	02	128
3 13 45 068 01 0	4014586366302	Extension hose	58.42	02	128
3 13 45 069 01 0	4014586366319	Repair set	31.08	02	128
3 13 45 070 01 0	4014586366326	Elbow	13.04	02	128

Accessories in numerical order

Part number	EAN	Description	£ List Price excl, VAT	PC	Page
3 13 45 071 01 0	4014586366333	Suction tube	31.08	02	128
3 13 45 071 02 0	4014586368528	Accessory set	85.74	02	129
3 13 45 072 01 0	4014586366340	Floor nozzle	39.78	02	128
3 13 45 073 01 0	4014586366357	Combination nozzle	37.28	02	128
3 13 45 074 01 0	4014586366364	Crevice nozzle	6.24	02	128
3 13 45 075 01 0	4014586366371	Upholstery nozzle	9.35	02	128
3 13 45 076 01 0	4014586366388	Suction brush,	11.82	02	128
3 13 45 077 01 0	4014586366395	Intake brush	21.00	02	128
3 13 45 078 01 0	4014586366401	Tool collar with suction force regulation	27.17	02	-
3 13 45 079 01 0	4014586366418	Stepped collar	13.94	02	128
3 13 45 119 01 0	4014586370187	Cable holder	6.81	02	128
3 13 45 120 01 0	4014586386119	Suction hose	172.74	02	128
3 13 45 121 01 0	4014586392059	Suction hose	172.74	02	128
3 13 45 123 01 0	4014586378596	Tool collar with suction force regulation	28.16	02	128
3 13 45 130 01 0	4014586379449	HEPA filter bag	99.06	02	129
3 13 45 133 02 0	4014586386126	Accessory set	86.93	02	129
3 13 45 137 01 0	4014586386133	Aluminium combi nozzle	110.14	02	128
3 13 45 250 01 0	4014586392066	Tool collar with suction force regulation	26.61	02	128
3 13 45 251 01 0	4014586392691	Premium fleece filter bag	51.94	02	129
3 13 45 263 01 0	4014586394459	Elbow	17.84	02	128
3 13 45 273 01 0	4014586409955	Premium fleece filter bag	38.94	02	129
3 14 14 024 01 0	4014586060187	Suction hose assy	86.72	02	-
3 14 14 054 00 8	4014586208916	Hose	3.56	02	107
3 14 14 059 01 0	4014586227108	Suction hose	51.72	02	-
3 14 14 070 01 0	4014586356433	Flex-jointed hose	14.18	02	120
3 14 15 020 00 8	4014586060392	Anti vibration mounts	40.82	02	69
3 14 15 081 00 1	4014586207865	Anti vibration mounts	17.42	02	69
3 14 20 120 01 0	4014586376677	Protection for AccuTEC ASM	20.99	02	36
3 14 20 131 01 0	4014586396408	BOP 10 protective cap	11.71	02	9
3 14 20 132 01 0	4014586396415	BOP 10-2 protective cap	11.71	02	9
3 14 26 030 00 5	4014586061641	Velcro fastener	18.08	02	139
3 14 26 067 01 6	4014586236797	Anti-slip mat	21.25	02	-
3 14 28 102 01 6	4014586195957	Anti-chipping protection, 5-pack	10.48	02	88
3 14 28 156 00 0	4014586272047	Plastic cover	8.24	02	-
3 18 01 010 01 2	4014586069210	Support	95.45	02	-
3 18 10 070 01 6	4014586069678	Protective cover assy	34.84	02	-
3 18 10 071 01 5	4014586069739	Protective cover assy	43.35	02	-
3 18 10 171 00 5	4014586070124	Suction hood	219.94	02	-
3 18 10 240 01 4	4014586228945	Suction hood	27.07	06	139
3 18 10 247 01 9	4014586241906	Chipping protector	20.70	02	-
3 18 10 264 01 0	4014586307343	Protect.suction hood	21.39	02	139
3 18 10 277 00 0	4014586326238	Wheel guard	12.27	02	-
3 18 10 299 00 0	4014586394107	Wheel guard	10.37	06	52
3 18 10 300 00 0	4014586394114	Wheel guard	10.51	06	136
3 18 10 301 00 0	4014586394121	Wheel guard	10.82	06	52
3 18 10 305 00 0	4014586407852	Wheel guard	34.22	02	-
3 21 09 061 01 6	4014586074542	Clamping chuck assy	87.37	02	-
3 21 19 032 00 2	4014586074689	Side handle	7.11	02	-
3 21 19 047 00 4	4014586074801	Handle	11.83	02	-
3 21 19 058 00 1	4014586074849	Handle	14.20	02	-
3 21 19 078 02 4	4014586074962	Handle ASS.	25.07	02	-
3 21 19 103 01 7	4014586215587	Handle ASS.	31.78	02	-
3 21 19 107 01 6	4014586222882	Handle ASS.	5.59	02	-
3 21 19 113 01 6	4014586235264	Handle ASS.	15.79	02	-
3 21 19 116 01 1	4014586267616	Bail handle	46.85	04	175
3 21 19 117 01 5	4014586268125	anti-vibration handle	39.08	02	55
3 21 19 118 01 3	4014586268132	anti-vibration handle	39.08	02	68
3 21 19 119 01 7	4014586268149	anti-vibration handle	39.08	02	-
3 21 19 124 01 0	4014586334783	anti-vibration handle	9.75	02	135
3 21 19 127 03 0	4014586351971	Starter awl	24.25	02	-
3 21 19 148 02 0	4014586404790	Additional handle	44.28	04	169
3 21 19 150 01 0	4014586404523	Handle	46.96	02	36
3 21 20 025 00 6	4014586075105	Extension for tube handle	31.92	02	-
3 21 23 002 00 6	4014586270906	Adjustment spanner - torque	8.46	02	35
3 21 25 043 00 4	4014586075341	Bow	7.74	02	-
3 21 25 050 00 7	4014586075396	Suspension Device	11.09	02	17
3 21 26 012 01 0	4014586410210	Tool holder	40.62	02	36
3 21 27 003 03 5	4014586075594	Depth stop	83.93	02	-
3 21 27 005 00 6	4014586075600	Depth stop	7.91	02	17
3 21 27 005 02 1	4014586075617	Depth stop	37.05	02	-
3 21 27 021 03 6	4014586075761	Stop sleeve	28.77	02	-
3 21 27 021 06 1	4014586075792	Stop sleeve	65.11	02	-
3 21 27 021 10 4	4014586250717	Stop sleeve	52.10	02	-
3 21 27 021 11 3	4014586250724	Stop sleeve	28.07	02	-
3 21 27 021 12 9	4014586258669	Stop sleeve	22.30	02	-
3 21 27 021 13 5	4014586262406	Stop sleeve	17.36	02	-
3 21 27 021 14 1	4014586270531	Depth stop assy	46.88	02	-





Part number	EAN	Description	£ List Price excl. VAT	PC	Page
3 21 27 021 15 0	4014586295343	Stop sleeve	24.38	02	-
3 21 27 043 00 0	4014586075983	Stop sleeve	18.00	02	-
3 21 27 057 00 8	4014586208831	Stop sleeve	18.98	02	-
3 21 27 059 00 0	4014586215594	Depth stop	10.90	02	-
3 21 27 065 01 9	4014586266077	Depth stop assy	40.27	02	-
3 21 27 069 01 0	4014586351674	Depth stop	20.15	04	159
3 21 32 020 12 9	4014586076706	Cutting paste	15.48	04	107
3 21 32 022 00 7	4014586076713	Pump	10.98	02	107
3 21 32 031 00 0	4014586289922	High-performance cutting oil spray	16.08	02	107
3 21 33 012 01 8	4014586076775	Feed screw	129.22	02	-
3 21 33 021 01 0	4014586404745	Device for dust extract	67.55	04	169
3 21 73 003 00 3	4014586265568	Work gloves, small, pair	100.18	04	136
3 21 73 004 00 1	4014586265575	Work gloves, mid-size, pair	100.18	04	136
3 21 73 005 00 5	4014586265582	Work gloves, large, pair	100.18	04	136
3 21 74 003 00 0	4014586077215	Protective cage	11.62	02	-
3 21 74 006 00 5	4014586199641	Ratchet buckle w/ strap	156.04	02	-
3 21 74 007 00 9	4014586214740	Ratchet buckle w/ strap	18.64	02	-
3 21 74 008 00 7	4014586241890	Strap, safety	18.33	02	-
3 21 74 011 00 0	4014586319056	Protective cover	6.81	04	178
3 21 74 013 01 0	4014586335773	Swarf cup	19.69	02	99
3 21 74 013 10 0	4014586353128	Protective cover	17.42	02	-
3 21 74 013 20 0	4014586353135	Protective cover	21.69	02	-
3 21 74 014 01 0	4014586376691	AccuTEC ASW protective cover	17.61	02	36
3 21 74 015 01 0	4014586376707	Battery cover	17.61	02	35
3 21 74 016 01 0	4014586376714	Battery cover	18.73	02	35
3 21 74 019 01 0	4014586404905	Battery cover	22.05	02	35
3 21 74 020 01 0	4014586404912	Battery cover	20.89	02	35
3 21 74 024 01 0	4014586404943	AccuTEC ASW protective cover	29.43	02	36
3 21 74 025 01 0	4014586415499	Battery cover	16.25	02	36
3 24 22 326 01 0	4014586369846	Adapter plate for magnetic core drills	47.89	02	14
3 26 23 009 00 6	4014586200699	Reducing rings	36.83	02	14
3 26 23 010 00 8	4014586200422	Reducing rings	36.83	02	14
3 26 23 012 01 9	4014586248776	Reducing rings	37.80	02	14
3 26 23 013 00 4	4014586248783	Reducing rings	29.56	02	14
3 26 23 014 01 0	4014586369853	Reducing rings	36.83	02	14
3 27 14 037 01 3	4014586091938	Clip assy	261.21	02	-
3 27 14 062 02 3	4014586092133	Hands-free support	225.41	02	92
3 27 14 071 01 3	4014586092201	Clamping jaw assy	42.68	02	-
3 27 14 084 00 8	4014586195872	Shoe plate	102.42	02	88
3 27 14 088 00 7	4014586200750	Chipping protector	5.20	02	88
3 39 01 021 01 1	4014586110165	Tool case	59.59	02	52
3 39 01 022 01 4	4014586110202	Tool case	54.75	02	55
3 39 01 032 01 3	4014586110257	Tool case	56.43	02	9
3 39 01 045 01 8	4014586110387	Tool case	46.47	02	-
3 39 01 073 01 3	4014586200002	Tool case	183.23	02	-
3 39 01 096 01 6	4014586242095	Tool case	204.91	02	-
3 39 01 100 02 0	4014586287980	Tool case assy for core drill	20.54	02	-
3 39 01 112 02 0	4014586317939	Tool case	91.01	04	-
3 39 01 118 01 0	4014586285474	Tool case	46.09	02	11
3 39 01 118 20 0	4014586302775	tool case - FSC	50.34	04	-
3 39 01 118 48 0	4014586317618	Tool case	50.95	02	8
3 39 01 118 93 0	4014586334974	Carrying case unfilled	50.48	04	-
3 39 01 119 00 0	4014586285498	Plastic box	4.54	02	11
3 39 01 121 02 0	4014586317946	Tool box ass.	218.36	02	-
3 39 01 122 01 0	4014586308791	Tool case	71.38	02	135
3 39 01 122 06 0	4014586321165	Tool case	81.58	02	-
3 39 01 122 12 0	4014586336732	Tool case	80.36	02	-
3 39 01 126 02 0	4014586332406	Tool box ass.	95.76	02	-
3 39 01 127 02 0	4014586325859	Tool box ass.	97.22	02	-
3 39 01 128 58 0	4014586367897	Tool case	51.28	02	-
3 39 01 128 82 0	4014586349435	Tool case	49.69	02	-
3 39 01 130 05 0	4014586333250	Tool case	83.27	02	-
3 39 01 131 03 0	4014586348957	Tool case	52.81	02	-
3 39 01 131 08 0	4014586348650	Tool case	52.81	02	16
3 39 01 131 92 0	4014586376325	Tool case	47.73	02	-
3 39 01 131 94 0	4014586379630	Tool case	50.27	02	11
3 39 01 131 98 0	4014586376332	Carrying case unfilled	49.50	04	169
3 39 01 132 03 0	4014586340449	Tool box ass.	93.97	02	-
3 39 01 133 05 0	4014586351247	Tool case	83.27	02	-
3 39 01 134 04 0	4014586340456	Tool box ass.	95.36	02	-
3 39 01 140 99 0	4014586356310	Tool case	95.60	02	-
3 39 01 141 01 0	4014586365244	Plastic tool cases	23.99	02	-
3 39 01 142 14 0	4014586356921	Tool box ass.	89.80	02	-
3 39 01 143 06 0	4014586356938	Tool box ass.	95.36	02	-
3 39 01 144 01 0	4014586356945	Carrying case unfilled	22.84	04	169
3 39 01 146 00 0	4014586380025	Systainer Sys 1	54.22	02	169
3 39 01 147 00 0	4014586380032	Systainer Sys 2	58.83	02	-

Accessories in numerical order

Part number	EAN	Description	£ List Price excl, VAT	PC	Page
3 39 01 152 00 0	4014586398396	Tool case	45.66	02	-
3 39 01 152 05 0	4014586407654	Tool case	56.40	04	-
3 39 01 152 07 0	4014586408118	Tool case	70.69	02	-
3 39 01 153 01 0	4014586398402	Tool case	21.01	04	-
3 39 01 154 03 0	4014586411903	Tool case	47.50	04	-
3 39 01 154 05 0	4014586403786	Tool case	44.94	04	-
3 39 01 155 02 0	4014586379647	Tool box ass.	210.06	02	-
3 39 01 157 31 0	4014586410586	Tool case	51.28	02	-
3 39 01 157 32 0	4014586410593	Tool case	51.28	02	-
3 39 01 160 01 0	4014586394091	Tool case	24.39	02	24
3 39 01 179 01 0	4014586408125	Tool case	70.69	02	-
3 39 04 491 00 0	4014586382999	Systainer insert for FMM 350 Q / QSL	10.55	06	169
3 39 04 542 00 0	4014586380056	Systainer insert for AFSC 18 Q	8.70	06	175
3 39 98 140 02 2	4014586622231	Tool case	84.72	02	-
3 39 98 140 08 2	4014586662039	Tool case	84.72	02	-
3 43 00 000 00 1	4014586402796	Contact guard	4.58	04	159
3 52 22 927 05 0	4014586392455	Adapter for FEIN oscillator (up to 2004)	10.65	04	168
3 52 22 942 04 0	4014586392462	Best of Sanding accessory set	62.15	04	163
3 52 22 942 05 0	4014586392479	Best of E-Cut accessory set	62.15	04	159
3 52 22 942 06 0	4014586392486	Best of Renovation accessory set	170.32	04	162
3 52 22 942 13 0	4014586397436	Best of E-Cut accessory set	104.40	04	-
3 52 22 946 01 0	4014586397443	Accessory set for interior construction work with wood	170.79	04	169
3 52 22 946 02 0	4014586397450	Accessory set for repairing/replacing windows	170.79	04	169
3 52 22 946 03 0	4014586397467	Accessory set for tile restoration/bathroom renovation	170.79	04	169
3 52 22 946 04 0	4014586397474	Accessory set for heating/sanitary installation	183.76	04	169
3 52 22 946 06 0	4014586397498	Composite set of accessories	183.76	04	-
3 52 22 952 01 0	4014586392516	HSS saw blade With depth stop	63.74	04	159
3 52 22 952 02 0	4014586392523	Saw and file set FMM SLP	25.71	04	167
3 52 22 952 03 0	4014586392530	E-Cut-Combo SLP	42.03	04	159
3 52 22 952 04 0	4014586392547	Adapter FSC	13.90	04	175
3 52 22 952 05 0	4014586392554	Adapter FSC Qi	13.90	04	175
3 52 22 952 10 0	4014586404721	Set of sanding sheets	10.24	04	165
3 52 22 952 11 0	4014586404479	Sanding sheet set, zirconium	19.16	04	165
3 52 22 952 13 0	4014586400389	E-Cut-Combo	39.13	04	-
3 52 22 952 18 0	4014586410319	Best of E-Cut accessory set	54.45	04	-
3 52 22 952 22 0	4014586413839	Set of accessories for renovating floors	40.76	04	162
3 52 22 952 23 0	4014586413846	Set of accessories for renovating windows	40.76	04	163
3 52 22 952 24 0	4014586413853	Universal set of accessories	40.76	04	163
3 52 22 952 25 0	4014586413860	Sanitary set of accessories	51.21	04	163
3 52 22 952 30 0	4014586415635	Best of E-Cut accessory set	39.90	04	159
3 90 00 000 00 1	4014586280028	Graphite 80 x 430 mm (5-pack)	106.40	06	203
3 90 00 000 00 2	4014586280035	Flexible hose Ø90, 1.0 m	59.43	06	204
3 90 00 000 00 4	4014586280059	Eye protection 75, triple pack	47.85	06	203
3 90 00 000 00 7	4014586280080	Eye protection GU75/GR/GXR (3 pieces)	78.86	06	203
3 90 00 000 05 6	4014586283517	Graphite 155 x 430 mm, 3-pack	122.29	06	205
3 90 00 000 10 0	4014586294162	Metal filter	127.54	06	206
3 90 00 000 18 3	4014586283500	Graphite pad	53.46	06	207
3 90 00 000 18 4	4014586283494	Eye protection 150, GU150 3-pack	94.32	06	205
3 90 00 000 49 6	4014586280325	Brassglide support	51.88	06	204
3 90 00 000 49 7	4014586280332	Nylon glide support	57.86	06	204
3 90 00 000 97 6	4014586286303	Filter t. GIBE, 523 x 241, forpakket	162.59	06	206
3 90 00 001 32 0	4014586294407	Chamfering unit old grit classic GZ	218.38	13	-
3 90 00 001 51 7	4014586297361	angle support for GF75	160.06	13	-
3 90 00 008 10 6	4014586389837	Stainless steel sanding support	75.83	02	187
4 06 11 009 01 9	4014586126760	Sealing ring set	9.77	02	-
4 11 40 004 00 7	4014586128399	Hose coupling	29.21	02	92
4 30 33 087 06 5	4014586225173	Set of clamping screws	8.42	04	-
6 01 10 008 01 7	4014586165790	Tool holder Ø 7 mm with external flat	26.93	02	-
6 05 03 306 00 8	4014586262772	Bit, 1/4" hexagon head	8.48	02	41
6 05 05 015 00 1	4014586258713	Insert, 1/4" hexagon head, SW 8	15.96	02	-
6 05 10 011 00 9	4014586235141	Tool holder 1/4" external hexagon	20.81	02	24
6 05 10 215 00 3	4014586258812	Tool holder 1/4" external hexagon	25.81	02	38
6 05 10 219 01 0	4014586367910	Bit holder	26.81	02	-
6 05 10 222 01 0	4014586404820	Bit holder	34.12	02	25
6 22 19 002 07 9	4014586168012	Socket for stay bolts	150.10	02	-
6 22 19 002 09 1	4014586168036	Socket for stay bolts	125.72	02	-
6 22 19 002 10 6	4014586168043	Socket for stay bolts	125.72	02	-
6 22 19 002 14 3	4014586168074	Socket for stay bolts	125.72	02	-
6 27 12 109 03 4	4014586169637	Bit, 1/4" hexagon head, 5-pack	9.12	02	41
6 29 01 002 00 4	4014586172071	Jaw spanner SW8	6.25	02	-
6 29 01 003 00 8	4014586172088	Jaw spanner SW9	6.25	02	-
6 29 01 007 00 7	4014586172125	Jaw spanner SW13	6.40	02	-
6 29 01 016 00 2	4014586172217	Jaw spanner SW46	17.60	02	-
6 29 03 002 00 9	4014586172255	Jaw spanner SW17	6.40	02	8
6 29 03 011 00 5	4014586172316	Jaw spanner SW17	3.98	02	-
6 29 04 003 00 0	4014586172347	Jaw spanner 19 x 22	6.40	02	-
6 29 06 009 00 7	4014586172415	Socket spanner SW 8	3.52	02	-



Part number	EAN	Description	£ List Price excl, VAT	PC	Page
6 29 06 013 00 5	4014586226101	Socket spanner SW46	46.00	02	-
6 29 07 004 00 5	4014586172446	Allen key SW6	1.84	02	-
6 29 07 006 00 2	4014586172453	Allen key SW8	1.81	02	-
6 29 07 010 00 0	4014586172477	Allen key SW4	1.84	02	-
6 29 07 011 00 9	4014586172484	Allen key SW5	1.81	02	-
6 29 07 013 00 6	4014586172491	Allen key SW3	1.81	02	-
6 29 07 015 00 8	4014586172514	Allen key SW2.5	1.81	02	-
6 29 07 017 00 5	4014586172521	Allen key SW4.5	6.58	02	-
6 29 07 023 00 5	4014586172545	Socket head wrench	1.81	02	-
6 29 07 029 00 6	4014586172590	Allen key SW2	1.81	02	-
6 29 07 030 00 8	4014586172606	Allen key SW8	3.86	02	-
6 29 07 034 00 2	4014586218618	Socket spanner SW4	1.81	02	-
6 29 07 037 00 3	4014586249728	Allen key	2.24	02	-
6 29 08 013 00 3	4014586172675	Sickle spanner	23.94	02	-
6 29 10 007 00 7	4014586172705	Bidirectional nut spanner	19.76	02	-
6 29 10 022 00 2	4014586172736	Bi-directional nut spanner	3.98	02	-
6 29 10 023 00 6	4014586172743	Bidirectional nut spanner	3.86	02	-
6 29 10 031 00 8	4014586172811	Bi-directional nut spanner	9.89	04	-
6 29 11 004 00 5	4014586172828	Ring spanner SW32	4.94	02	-
6 29 12 001 00 4	4014586266107	Screwdriver	15.00	02	-
6 29 13 004 00 0	4014586172859	Retaining pin	4.14	02	-
6 29 13 020 00 4	4014586172927	Retaining pin	1.29	02	-
6 29 13 021 00 3	4014586208688	Retaining pin	3.42	02	-
6 29 14 001 00 2	4014586172934	Chuck key	4.99	02	-
6 29 14 002 00 5	4014586172941	Chuck key	2.37	02	-
6 29 14 004 00 7	4014586172958	Chuck key	4.62	02	-
6 29 14 005 00 1	4014586172965	Chuck key	12.27	02	-
6 29 14 011 00 1	4014586173016	Chuck key	7.30	02	-
6 31 06 016 01 0	4014586271767	Extension 100 mm QI	83.72	02	118
6 31 06 017 01 0	4014586335063	Extension QIP 100 mm	75.09	02	99
6 31 10 019 01 0	4014586415680	Tapping drill for through holes	15.09	02	107
6 31 10 019 02 0	4014586416069	Tapping drill set for through holes	110.24	02	107
6 31 10 019 03 0	4014586416076	Tapping drill for through holes with adapter with 3/4" Weldon fitting	37.13	02	107
6 31 10 020 01 0	4014586415697	Tapping drill for through holes	17.41	02	107
6 31 10 020 02 0	4014586416083	Tapping drill for through holes	110.24	02	107
6 31 10 020 03 0	4014586416090	Tapping drill for through holes with adapter with 3/4" Weldon fitting	39.45	02	107
6 31 10 021 01 0	4014586415703	Tapping drill for through holes	20.89	02	107
6 31 10 021 02 0	4014586416106	Tapping drill set for through holes	114.88	02	107
6 31 10 021 03 0	4014586416113	Tapping drill for through holes with adapter with 3/4" Weldon fitting	42.94	02	107
6 31 10 022 01 0	4014586415710	Tapping drill for through holes	23.21	02	107
6 31 10 022 02 0	4014586416120	Tapping drill set for through holes	114.88	02	107
6 31 10 022 03 0	4014586416137	Tapping drill for through holes with adapter with 3/4" Weldon fitting	45.26	02	107
6 31 11 009 01 0	4014586326597	Twist drill D10 HSS QI	21.25	02	118
6 31 11 010 01 0	4014586326603	Twist drill D10.2 HSS QI	21.25	02	118
6 31 11 011 01 0	4014586326610	Twist drill D11 HSS QI	24.19	02	118
6 31 11 012 01 0	4014586326627	Twist drill D12 HSS QI	24.19	02	118
6 31 11 013 01 0	4014586326634	Twist drill D13 HSS QI	25.96	02	118
6 31 11 014 01 0	4014586326641	Twist drill D14 HSS QI	25.96	02	118
6 31 11 015 01 0	4014586326658	Twist drill D15 HSS QI	27.14	02	118
6 31 11 016 01 0	4014586326665	Twist drill D15.5 HSS QI	27.14	02	118
6 31 11 018 01 0	4014586409085	HSS twist drill with 3/4" Weldon fitting	19.73	02	106
6 31 11 018 02 0	4014586416144	HSS twist drill set with 3/4" Weldon fitting	150.86	02	106
6 31 11 019 01 0	4014586409092	HSS twist drill with 3/4" Weldon fitting	19.73	02	106
6 31 11 020 01 0	4014586409108	HSS twist drill with 3/4" Weldon fitting	19.73	02	106
6 31 11 021 01 0	4014586409115	HSS twist drill with 3/4" Weldon fitting	20.89	02	106
6 31 11 022 01 0	4014586409122	HSS twist drill with 3/4" Weldon fitting	20.89	02	106
6 31 11 023 01 0	4014586409139	HSS twist drill with 3/4" Weldon fitting	23.79	02	106
6 31 11 024 01 0	4014586409146	HSS twist drill with 3/4" Weldon fitting	23.79	02	106
6 31 11 025 01 0	4014586409153	HSS twist drill with 3/4" Weldon fitting	25.53	02	106
6 31 11 026 01 0	4014586409160	HSS twist drill with 3/4" Weldon fitting	25.53	02	106
6 31 11 027 01 0	4014586409177	HSS twist drill with 3/4" Weldon fitting	29.01	02	106
6 31 11 028 01 0	4014586409184	HSS twist drill with 3/4" Weldon fitting	29.01	02	106
6 31 11 034 01 0	4014586409658	HSS twist drill with 3/4" Weldon fitting	19.73	02	106
6 31 11 035 01 0	4014586409665	HSS twist drill with 3/4" Weldon fitting	20.89	02	106
6 31 11 036 01 0	4014586415109	HSS twist drill with 3/4" Weldon fitting	19.73	02	106
6 31 11 037 01 0	4014586415116	HSS twist drill with 3/4" Weldon fitting	23.79	02	106
6 31 11 038 01 0	4014586415727	HSS 90° countersink bit	18.57	02	106
6 31 11 038 02 0	4014586416168	HSS 90° countersink bit with adapter with 3/4" Weldon fitting	40.62	02	106
6 31 14 038 01 0	4014586331027	Centring drill bit	16.69	02	98
6 31 14 038 02 0	4014586332796	Centring drill long pack of 5	74.97	02	98
6 31 27 001 01 5	4014586176130	HM Ultra50 core drill Ø18 M18 x 6 P 1.5	58.20	20	112
6 31 27 002 01 8	4014586176147	HM Ultra50 core drill Ø20 M18 x 6 P 1,5	58.20	20	112
6 31 27 003 01 2	4014586176154	HM Ultra50 core drill Ø22 M18 x 6 P 1,5	58.20	20	113
6 31 27 004 01 0	4014586176161	HM Ultra50 core drill Ø25 M18 x 6 P 1,5	58.20	20	113
6 31 27 005 01 4	4014586176178	HM Ultra50 core drill Ø26 M18 x 6 P 1,5	56.72	20	113
6 31 27 006 01 7	4014586176185	HM Ultra50 core drill Ø28 M18 x 6 P 1,5	58.20	20	113
6 31 27 007 01 1	4014586176192	HM Ultra50 core drill Ø30 M18 x 6 P 1,5	58.20	20	113

Accessories in numerical order

Part number	EAN	Description	£ List Price excl, VAT	PC	Page
6 31 27 008 01 9	4014586176208	HM Ultra50 core drill Ø32 M18 x 6 P 1,5	63.40	20	113
6 31 27 009 01 3	4014586176215	HM Ultra50 core drill Ø34 M18 x 6 P 1,5	63.40	20	113
6 31 27 010 01 5	4014586176222	HM Ultra50 core drill Ø35 M18 x 6 P 1,5	65.02	20	113
6 31 27 011 01 4	4014586176239	HM Ultra50 core drill Ø38 M18 x 6 P 1,5	73.41	20	113
6 31 27 012 01 7	4014586176246	HM Ultra50 core drill Ø40 M18 x 6 P 1,5	75.29	20	113
6 31 27 013 01 1	4014586176253	HM Ultra50 core drill Ø42 M18 x 6 P 1,5	86.69	20	113
6 31 27 014 01 9	4014586176260	HM Ultra50 core drill Ø43 M18 x 6 P 1,5	88.92	20	113
6 31 27 015 01 3	4014586176277	HM Ultra50 core drill Ø45 M18 x 6 P 1,5	86.69	20	113
6 31 27 016 01 6	4014586176284	HM Ultra50 core drill Ø48 M18 x 6 P 1,5	99.31	20	113
6 31 27 017 01 0	4014586176291	HM Ultra50 core drill Ø50 M18 x 6 P 1,5	96.79	20	113
6 31 27 018 01 8	4014586176307	HM Ultra50 core drill Ø52 M18 x 6 P 1,5	106.95	20	113
6 31 27 019 01 2	4014586176314	HM Ultra50 core drill Ø19 M18 x 6 P 1,5	56.72	20	112
6 31 27 020 01 4	4014586176321	HM Ultra50 core drill Ø21 M18 x 6 P 1,5	58.20	20	113
6 31 27 021 01 3	4014586176338	HM Ultra50 core drill Ø23 M18 x 6 P 1,5	58.20	20	113
6 31 27 022 01 6	4014586176345	HM Ultra50 core drill Ø24 M18 x 6 P 1,5	56.72	20	113
6 31 27 023 01 0	4014586176352	HM Ultra50 core drill Ø27 M18 x 6 P 1,5	56.72	20	113
6 31 27 024 01 8	4014586176369	HM Ultra50 core drill Ø29 M18 x 6 P 1,5	58.20	20	113
6 31 27 025 01 2	4014586176376	HM Ultra50 core drill Ø31 M18 x 6 P 1,5	65.02	20	113
6 31 27 026 01 5	4014586176383	HM Ultra50 core drill Ø33 M18 x 6 P 1,5	63.40	20	113
6 31 27 027 01 9	4014586176390	HM Ultra50 core drill Ø36 M18 x 6 P 1,5	75.29	20	113
6 31 27 028 01 7	4014586176406	HM Ultra50 core drill Ø37 M18 x 6 P 1,5	75.29	20	113
6 31 27 029 01 1	4014586176413	HM Ultra50 core drill Ø39 M18 x 6 P 1,5	75.29	20	113
6 31 27 030 01 3	4014586176420	HM Ultra50 core drill Ø41 M18 x 6 P 1,5	86.69	20	113
6 31 27 031 01 2	4014586176437	HM Ultra50 core drill Ø44 M18 x 6 P 1,5	88.92	20	113
6 31 27 032 01 5	4014586176444	HM Ultra50 core drill Ø46 M18 x 6 P 1,5	99.31	20	113
6 31 27 033 01 9	4014586176451	HM Ultra50 core drill Ø47 M18 x 6 P 1,5	96.79	20	113
6 31 27 034 01 7	4014586176468	HM Ultra50 core drill Ø49 M18 x 6 P 1,5	96.79	20	113
6 31 27 035 01 1	4014586176475	HM Ultra50 core drill Ø51 M18 x 6 P 1,5	109.73	20	113
6 31 27 036 01 4	4014586192369	HM Ultra50 core drill Ø53 M18 x 6 P 1,5	109.73	20	113
6 31 27 037 01 8	4014586192376	HM Ultra50 core drill Ø54 M18 x 6 P 1,5	106.95	20	113
6 31 27 038 01 6	4014586192383	HM Ultra50 core drill Ø55 M18 x 6 P 1,5	106.95	20	113
6 31 27 039 01 0	4014586192390	HM Ultra50 core drill Ø56 M18 x 6 P 1,5	111.47	20	113
6 31 27 040 01 2	4014586192406	HM Ultra50 core drill Ø57 M18 x 6 P 1,5	111.47	20	113
6 31 27 041 01 1	4014586192413	HM Ultra50 core drill Ø58 M18 x 6 P 1,5	111.47	20	113
6 31 27 042 01 4	4014586200941	HM Ultra50 core drill Ø12 M18 x 6 P 1,5	56.72	20	112
6 31 27 043 01 8	4014586200958	HM Ultra50 core drill Ø13 M18 x 6 P 1,5	56.72	20	112
6 31 27 044 01 6	4014586200965	HM Ultra50 core drill Ø14 M18 x 6 P 1,5	58.20	20	112
6 31 27 045 01 0	4014586200972	HM Ultra50 core drill Ø15 M18 x 6 P 1,5	56.72	20	112
6 31 27 046 01 3	4014586200989	HM Ultra50 core drill Ø16 M18 x 6 P 1,5	58.20	20	112
6 31 27 047 01 7	4014586200996	HM Ultra50 core drill Ø17 M18 x 6 P 1,5	58.20	20	112
6 31 27 049 01 9	4014586223179	HM Ultra50 core drill Ø59 M18 x 6 P 1,5	113.11	20	113
6 31 27 050 01 1	4014586223186	HM Ultra50 core drill Ø60 M18 x 6 P 1,5	116.00	20	113
6 31 27 051 01 0	4014586223193	HM Ultra50 core drill Ø61 M18 x 6 P 1,5	128.00	20	113
6 31 27 052 01 3	4014586223209	HM Ultra50 core drill Ø62 M18 x 6 P 1,5	128.00	20	113
6 31 27 053 01 7	4014586223216	HM Ultra50 core drill Ø63 M18 x 6 P 1,5	128.00	20	113
6 31 27 054 01 5	4014586223223	HM Ultra50 core drill Ø64 M18 x 6 P 1,5	128.00	20	113
6 31 27 055 01 9	4014586223230	HM Ultra50 core drill Ø65 M18 x 6 P 1,5	131.33	20	113
6 31 27 061 01 9	4014586229447	Core drill Ø90	275.30	20	-
6 31 27 086 01 9	4014586239996	HM Ultra core drill Ø12/35 HM QI	53.90	20	112
6 31 27 086 04 0	4014586375533	Best of core bits HM Ultra 35 QI 12,14,16,18,20,22 mm accessory set	253.77	20	112
6 31 27 087 01 3	4014586240008	HM Ultra-core drill Ø13/35 HM QI	53.90	20	112
6 31 27 088 01 1	4014586240015	HM Ultra-core drill Ø14/35 HM QI	53.90	20	112
6 31 27 089 01 5	4014586240022	HM Ultra-core drill Ø15/35 HM QI	53.90	20	112
6 31 27 090 01 7	4014586240039	HM Ultra-core drill Ø16/35 HM QI	53.90	20	112
6 31 27 091 01 6	4014586240046	HM Ultra-core drill Ø17/35 HM QI	53.90	20	112
6 31 27 092 01 9	4014586240053	HM Ultra-core drill Ø18/35 HM QI	53.90	20	112
6 31 27 093 01 3	4014586240060	HM Ultra-core drill Ø19/35 HM QI	53.90	20	112
6 31 27 094 01 1	4014586240077	HM Ultra-core drill Ø20/35 HM QI	53.90	20	112
6 31 27 095 01 5	4014586240084	HM Ultra-core drill Ø21/35 HM QI	53.90	20	112
6 31 27 096 01 8	4014586240091	HM Ultra-core drill Ø22/35 HM QI	53.90	20	112
6 31 27 097 01 2	4014586240107	HM Ultra-core drill Ø23/35 HM QI	53.90	20	112
6 31 27 098 01 0	4014586240114	HM Ultra-core drill Ø24/35 HM QI	53.90	20	112
6 31 27 099 01 4	4014586240121	HM Ultra-core drill Ø25/35 HM QI	53.90	20	112
6 31 27 100 01 5	4014586240138	HM Ultra-core drill Ø26/35 HM QI	53.90	20	112
6 31 27 101 01 4	4014586240145	HM Ultra-core drill Ø27/35 HM QI	53.90	20	112
6 31 27 102 01 7	4014586240152	HM Ultra-core drill Ø28/35 HM QI	53.90	20	112
6 31 27 103 01 1	4014586240169	HM Ultra-core drill Ø29/35 HM QI	60.48	20	112
6 31 27 104 01 9	4014586240176	HM Ultra-core drill Ø30/35 HM QI	62.07	20	112
6 31 27 105 01 3	4014586240183	HM Ultra-core drill Ø31/35 HM QI	62.07	20	112
6 31 27 106 01 6	4014586240190	HM Ultra-core drill Ø32/35 HM QI	62.07	20	112
6 31 27 107 01 0	4014586240206	HM Ultra-core drill Ø33/35 HM QI	62.07	20	112
6 31 27 108 01 8	4014586240213	HM Ultra-core drill Ø34/35 HM QI	62.07	20	112
6 31 27 109 01 2	4014586240220	HM Ultra-core drill Ø35/35 HM QI	62.07	20	112
6 31 27 110 01 4	4014586240237	HM Ultra-core drill Ø36/35 HM QI	71.83	20	112
6 31 27 111 01 3	4014586240244	HM Ultra-core drill Ø37/35 HM QI	70.03	20	112
6 31 27 112 01 6	4014586240251	HM Ultra-core drill Ø38/35 HM QI	71.83	20	112
6 31 27 113 01 0	4014586240268	HM Ultra-core drill Ø39/35 HM QI	70.03	20	112



Part number	EAN	Description	£ List Price excl. VAT	PC	Page
6 31 27 114 01 8	4014586240275	HM Ultra-core drill Ø40/35 HM QI	71.83	20	112
6 31 27 115 01 2	4014586240282	HM Ultra-core drill Ø41/35 HM QI	84.92	20	112
6 31 27 116 01 5	4014586240299	HM Ultra-core drill Ø42/35 HM QI	84.92	20	112
6 31 27 117 01 9	4014586240305	HM Ultra-core drill Ø43/35 HM QI	82.76	20	112
6 31 27 118 01 7	4014586240312	HM Ultra-core drill Ø44/35 HM QI	84.92	20	112
6 31 27 119 01 1	4014586240329	HM Ultra-core drill Ø45/35 HM QI	84.92	20	112
6 31 27 120 01 3	4014586240336	HM Ultra-core drill Ø46/35 HM QI	92.37	20	112
6 31 27 121 01 2	4014586240343	HM Ultra-core drill Ø47/35 HM QI	92.37	20	112
6 31 27 122 01 5	4014586240350	HM Ultra-core drill Ø48/35 HM QI	92.37	20	112
6 31 27 123 01 9	4014586240367	HM Ultra-core drill Ø49/35 HM QI	92.37	20	112
6 31 27 124 01 7	4014586240374	HM Ultra-core drill Ø50/35 HM QI	94.77	20	112
6 31 27 125 01 1	4014586240381	HM Ultra-core drill Ø51/35 HM QI	104.62	20	112
6 31 27 126 01 4	4014586240398	HM Ultra-core drill Ø52/35 HM QI	104.62	20	112
6 31 27 127 01 8	4014586240404	HM Ultra-core drill Ø53/35 HM QI	96.76	20	112
6 31 27 128 01 6	4014586240411	HM Ultra-core drill Ø54/35 HM QI	104.62	20	112
6 31 27 129 01 0	4014586240428	HM Ultra-core drill Ø55/35 HM QI	104.62	20	112
6 31 27 130 01 2	4014586240435	HM Ultra-core drill Ø56/35 HM QI	106.42	20	112
6 31 27 131 01 1	4014586240442	HM Ultra-core drill Ø57/35 HM QI	106.42	20	112
6 31 27 132 01 4	4014586240459	HM Ultra-core drill Ø58/35 HM QI	106.42	20	112
6 31 27 133 01 8	4014586240466	HM Ultra-core drill Ø59/35 HM QI	106.42	20	112
6 31 27 134 01 6	4014586240473	HM Ultra-core drill Ø60/35 HM QI	109.18	20	112
6 31 27 135 01 0	4014586240480	HM Ultra-core drill Ø61/35 HM QI	123.48	20	112
6 31 27 136 01 3	4014586240497	HM Ultra-core drill Ø62/35 HM QI	120.37	20	112
6 31 27 137 01 7	4014586240503	HM Ultra-core drill Ø63/35 HM QI	123.48	20	112
6 31 27 138 01 5	4014586240510	HM Ultra-core drill Ø64/35 HM QI	120.37	20	112
6 31 27 139 01 9	4014586240527	HM Ultra-core drill Ø65/35 HM QI	123.48	20	112
6 31 27 238 01 1	4014586252469	HM Ultra-core drill Ø15.5/35 HM QI	52.56	20	112
6 31 27 239 01 5	4014586252476	HM Ultra-core drill Ø17.5/35 HM QI	53.90	20	112
6 31 27 240 01 7	4014586252483	HM Ultra-core drill Ø19.5/35 HM QI	49.87	20	112
6 31 27 241 01 6	4014586252490	HM Ultra-core drill Ø26.5/35 HM QI	52.56	20	112
6 31 27 276 01 0	4014586272122	HM Ultra50 core drill Weldon Ø12/50	56.72	20	113
6 31 27 276 02 0	4014586375540	Best of core bits HM Ultra 50 W 12,14,16,18,20,22 mm accessory set	292.05	20	112
6 31 27 277 01 0	4014586272139	HM Ultra50 core drill Weldon Ø13/50	53.81	20	113
6 31 27 278 01 0	4014586272146	HM Ultra50 core drill Weldon Ø14/50	56.72	20	113
6 31 27 279 01 0	4014586272153	HM Ultra50 core drill Weldon Ø15/50	56.72	20	113
6 31 27 280 01 0	4014586272160	HM Ultra50 core drill Weldon Ø16/50	56.72	20	113
6 31 27 281 01 0	4014586272177	HM Ultra50 core drill Weldon Ø17/50	56.72	20	113
6 31 27 282 01 0	4014586272184	HM Ultra50 core drill Weldon Ø18/50	56.72	20	113
6 31 27 283 01 0	4014586272191	HM Ultra50 core drill Weldon Ø19/50	56.72	20	113
6 31 27 284 01 0	4014586272207	HM Ultra50 core drill Weldon Ø20/50	56.72	20	113
6 31 27 285 01 0	4014586272214	HM Ultra50 core drill Weldon Ø21/50	56.72	20	113
6 31 27 286 01 0	4014586272221	HM Ultra50 core drill Weldon Ø22/50	56.72	20	113
6 31 27 287 01 0	4014586272238	HM Ultra50 core drill Weldon Ø23/50	56.72	20	113
6 31 27 288 01 0	4014586272245	HM Ultra50 core drill Weldon Ø24/50	56.72	20	113
6 31 27 289 01 0	4014586272252	HM Ultra50 core drill Weldon Ø25/50	56.72	20	113
6 31 27 290 01 0	4014586272269	HM Ultra50 core drill Weldon Ø26/50	56.72	20	113
6 31 27 291 01 0	4014586272276	HM Ultra50 core drill Weldon Ø27/50	56.72	20	113
6 31 27 292 01 0	4014586272283	HM Ultra50 core drill Weldon Ø28/50	56.72	20	113
6 31 27 293 01 0	4014586272290	HM Ultra50 core drill Weldon Ø29/50	56.72	20	113
6 31 27 294 01 0	4014586272306	HM Ultra50 core drill Weldon Ø30/50	56.72	20	113
6 31 27 295 01 0	4014586272313	HM Ultra50 core drill Weldon Ø31/50	63.40	20	113
6 31 27 296 01 0	4014586272320	HM Ultra50 core drill Weldon Ø32/50	63.40	20	113
6 31 27 297 01 0	4014586272337	HM Ultra50 core drill Weldon Ø33/50	63.40	20	113
6 31 27 298 01 0	4014586272344	HM Ultra50 core drill Weldon Ø34/50	63.40	20	113
6 31 27 299 01 0	4014586272351	HM Ultra50 core drill Weldon Ø35/50	63.40	20	113
6 31 27 300 01 0	4014586272368	HM Ultra50 core drill Weldon Ø36/50	73.41	20	113
6 31 27 301 01 0	4014586272375	HM Ultra50 core drill Weldon Ø37/50	73.41	20	113
6 31 27 302 01 0	4014586272382	HM Ultra50 core drill Weldon Ø38/50	73.41	20	113
6 31 27 303 01 0	4014586272399	HM Ultra50 core drill Weldon Ø39/50	73.41	20	113
6 31 27 304 01 0	4014586272405	HM Ultra50 core drill Weldon Ø40/50	73.41	20	114
6 31 27 305 01 0	4014586272412	HM Ultra50 core drill Weldon Ø41/50	86.69	20	114
6 31 27 306 01 0	4014586272429	HM Ultra50 core drill Weldon Ø42/50	86.69	20	114
6 31 27 307 01 0	4014586272436	HM Ultra50 core drill Weldon Ø43/50	86.69	20	114
6 31 27 308 01 0	4014586272443	HM Ultra50 core drill Weldon Ø44/50	86.69	20	114
6 31 27 309 01 0	4014586272450	HM Ultra50 core drill Weldon Ø45/50	86.69	20	114
6 31 27 310 01 0	4014586272467	HM Ultra50 core drill Weldon Ø46/50	96.79	20	114
6 31 27 311 01 0	4014586272474	HM Ultra50 core drill Weldon Ø47/50	96.79	20	114
6 31 27 312 01 0	4014586272481	HM Ultra50 core drill Weldon Ø48/50	96.79	20	114
6 31 27 313 01 0	4014586272498	HM Ultra50 core drill Weldon Ø49/50	96.79	20	114
6 31 27 314 01 0	4014586272504	HM Ultra50 core drill Weldon Ø50/50	96.79	20	114
6 31 27 315 01 0	4014586272511	HM Ultra50 core drill Weldon Ø51/50	106.95	20	114
6 31 27 316 01 0	4014586272528	HM Ultra50 core drill Weldon Ø52/50	106.95	20	114
6 31 27 317 01 0	4014586272535	HM Ultra50 core drill Weldon Ø53/50	106.95	20	114
6 31 27 318 01 0	4014586272542	HM Ultra50 core drill Weldon Ø54/50	106.95	20	114
6 31 27 319 01 0	4014586272559	HM Ultra50 core drill Weldon Ø55/50	106.95	20	114
6 31 27 320 01 0	4014586272566	HM Ultra50 core drill Weldon Ø56/50	111.47	20	114
6 31 27 321 01 0	4014586272573	HM Ultra50 core drill Weldon Ø57/50	111.47	20	114

Accessories in numerical order

Part number	EAN	Description	£ List Price excl, VAT	PC	Page
6 31 27 322 01 0	4014586272580	HM Ultra50 core drill Weldon Ø58/50	111.47	20	114
6 31 27 323 01 0	4014586272597	HM Ultra50 core drill Weldon Ø59/50	111.47	20	114
6 31 27 324 01 0	4014586272603	HM Ultra50 core drill Weldon Ø60/50	111.47	20	114
6 31 27 325 01 0	4014586272610	HM Ultra50 core drill Weldon Ø61/50	126.14	20	114
6 31 27 326 01 0	4014586272627	HM Ultra50 core drill Weldon Ø62/50	126.14	20	114
6 31 27 327 01 0	4014586272634	HM Ultra50 core drill Weldon Ø63/50	126.14	20	114
6 31 27 328 01 0	4014586272641	HM Ultra50 core drill Weldon Ø64/50	126.14	20	114
6 31 27 329 01 0	4014586272658	HM Ultra50 core drill Weldon Ø65/50	126.14	20	114
6 31 27 330 01 0	4014586279732	HM Ultra50 core drill QuickIN MAX Ø50/50	96.79	20	122
6 31 27 331 01 0	4014586279749	HM Ultra50 core drill QuickIN MAX Ø51/50	109.73	20	122
6 31 27 332 01 0	4014586279756	HM Ultra50 core drill QuickIN MAX Ø52/50	109.73	20	122
6 31 27 333 01 0	4014586279763	HM Ultra50 core drill QuickIN MAX Ø53/50	106.95	20	122
6 31 27 334 01 0	4014586279770	HM Ultra50 core drill QuickIN MAX Ø54/50	106.95	20	122
6 31 27 335 01 0	4014586279787	HM Ultra50 core drill QuickIN MAX Ø55/50	106.95	20	122
6 31 27 336 01 0	4014586279794	HM Ultra50 core drill QuickIN MAX Ø56/50	111.47	20	122
6 31 27 337 01 0	4014586279800	HM Ultra50 core drill QuickIN MAX Ø57/50	111.47	20	122
6 31 27 338 01 0	4014586279817	HM Ultra50 core drill QuickIN MAX Ø58/50	111.47	20	122
6 31 27 339 01 0	4014586279824	HM Ultra50 core drill QuickIN MAX Ø59/50	111.47	20	122
6 31 27 340 01 0	4014586279831	HM Ultra50 core drill QuickIN MAX Ø60/50	111.47	20	122
6 31 27 341 01 0	4014586279848	HM Ultra50 core drill QuickIN MAX Ø61/50	126.14	20	122
6 31 27 342 01 0	4014586279855	HM Ultra50 core drill QuickIN MAX Ø62/50	126.14	20	122
6 31 27 343 01 0	4014586279862	HM Ultra50 core drill QuickIN MAX Ø63/50	126.14	20	122
6 31 27 344 01 0	4014586279879	HM Ultra50 core drill QuickIN MAX Ø64/50	126.14	20	122
6 31 27 345 01 0	4014586279886	HM Ultra50 core drill QuickIN MAX Ø65/50	126.14	20	122
6 31 27 346 01 0	4014586279893	HM Ultra50 core drill QuickIN MAX Ø66/50	144.71	20	122
6 31 27 347 01 0	4014586279909	HM Ultra50 core drill QuickIN MAX Ø67/50	144.71	20	122
6 31 27 348 01 0	4014586279916	HM Ultra50 core drill QuickIN MAX Ø68/50	144.71	20	122
6 31 27 349 01 0	4014586279923	HM Ultra50 core drill QuickIN MAX Ø69/50	144.71	20	122
6 31 27 350 01 0	4014586279930	HM Ultra50 core drill QuickIN MAX Ø70/50	159.82	20	122
6 31 27 351 01 0	4014586279947	HM Ultra50 core drill QuickIN MAX Ø71/50	161.34	20	122
6 31 27 352 01 0	4014586279954	HM Ultra50 core drill QuickIN MAX Ø72/50	162.85	20	122
6 31 27 353 01 0	4014586279961	HM Ultra50 core drill QuickIN MAX Ø73/50	164.36	20	122
6 31 27 354 01 0	4014586279978	HM Ultra50 core drill QuickIN MAX Ø74/50	165.88	20	122
6 31 27 355 01 0	4014586279985	HM Ultra50 core drill QuickIN MAX Ø75/50	167.37	20	122
6 31 27 456 01 0	4014586304083	HM Ultra50 core drill QuickIN MAX Ø76/50	174.92	20	122
6 31 27 457 01 0	4014586304090	HM Ultra50 core drill QuickIN MAX Ø77/50	176.44	20	122
6 31 27 458 01 0	4014586304106	HM Ultra50 core drill QuickIN MAX Ø78/50	178.67	20	122
6 31 27 459 01 0	4014586304113	HM Ultra50 core drill QuickIN MAX Ø79/50	180.98	20	122
6 31 27 460 01 0	4014586304120	HM Ultra50 core drill QuickIN MAX Ø80/50	180.98	20	122
6 31 27 714 01 0	4014586346632	TCT Ultra 35 core bit with 3/4" Weldon holder	48.43	20	106
6 31 27 714 02 0	4014586375557	Best of core bits HM Ultra 35 W 12,14,16,18,20,22 mm accessory set	253.77	20	103
6 31 27 715 01 0	4014586346649	TCT Ultra 35 core bit with 3/4" Weldon holder	48.43	20	106
6 31 27 716 01 0	4014586346656	TCT Ultra 35 core bit with 3/4" Weldon holder	48.39	20	106
6 31 27 717 01 0	4014586346663	TCT Ultra 35 core bit with 3/4" Weldon holder	48.43	20	106
6 31 27 718 01 0	4014586346670	TCT Ultra 35 core bit with 3/4" Weldon holder	48.43	20	106
6 31 27 719 01 0	4014586346687	TCT Ultra 35 core bit with 3/4" Weldon holder	48.43	20	106
6 31 27 720 01 0	4014586346694	TCT Ultra 35 core bit with 3/4" Weldon holder	48.39	20	106
6 31 27 721 01 0	4014586346700	TCT Ultra 35 core bit with 3/4" Weldon holder	48.43	20	106
6 31 27 722 01 0	4014586346717	TCT Ultra 35 core bit with 3/4" Weldon holder	48.43	20	106
6 31 27 723 01 0	4014586346724	TCT Ultra 35 core bit with 3/4" Weldon holder	48.43	20	106
6 31 27 724 01 0	4014586346731	TCT Ultra 35 core bit with 3/4" Weldon holder	48.43	20	106
6 31 27 725 01 0	4014586346748	TCT Ultra 35 core bit with 3/4" Weldon holder	48.43	20	106
6 31 27 726 01 0	4014586346755	TCT Ultra 35 core bit with 3/4" Weldon holder	48.43	20	106
6 31 27 727 01 0	4014586346762	TCT Ultra 35 core bit with 3/4" Weldon holder	48.43	20	106
6 31 27 728 01 0	4014586346779	TCT Ultra 35 core bit with 3/4" Weldon holder	48.43	20	106
6 31 27 729 01 0	4014586346786	TCT Ultra 35 core bit with 3/4" Weldon holder	48.43	20	106
6 31 27 730 01 0	4014586346793	TCT Ultra 35 core bit with 3/4" Weldon holder	48.43	20	106
6 31 27 731 01 0	4014586346809	TCT Ultra 35 core bit with 3/4" Weldon holder	55.72	20	106
6 31 27 732 01 0	4014586346816	TCT Ultra 35 core bit with 3/4" Weldon holder	55.72	20	106
6 31 27 733 01 0	4014586346823	TCT Ultra 35 core bit with 3/4" Weldon holder	55.72	20	106
6 31 27 734 01 0	4014586346830	TCT Ultra 35 core bit with 3/4" Weldon holder	55.72	20	106
6 31 27 735 01 0	4014586346847	TCT Ultra 35 core bit with 3/4" Weldon holder	55.72	20	106
6 31 27 736 01 0	4014586346854	TCT Ultra 35 core bit with 3/4" Weldon holder	55.72	20	106
6 31 27 737 01 0	4014586346861	TCT Ultra 35 core bit with 3/4" Weldon holder	55.72	20	106
6 31 27 738 01 0	4014586346878	TCT Ultra 35 core bit with 3/4" Weldon holder	67.99	20	106
6 31 27 739 01 0	4014586346885	TCT Ultra 35 core bit with 3/4" Weldon holder	67.99	20	106
6 31 27 740 01 0	4014586346892	TCT Ultra 35 core bit with 3/4" Weldon holder	67.99	20	106
6 31 27 741 01 0	4014586346908	TCT Ultra 35 core bit with 3/4" Weldon holder	67.99	20	106
6 31 27 742 01 0	4014586346915	TCT Ultra 35 core bit with 3/4" Weldon holder	67.99	20	106
6 31 27 743 01 0	4014586346922	TCT Ultra 35 core bit with 3/4" Weldon holder	80.36	20	106
6 31 27 744 01 0	4014586346939	TCT Ultra 35 core bit with 3/4" Weldon holder	80.36	20	106
6 31 27 745 01 0	4014586346946	TCT Ultra 35 core bit with 3/4" Weldon holder	80.36	20	106
6 31 27 746 01 0	4014586346953	TCT Ultra 35 core bit with 3/4" Weldon holder	80.36	20	106
6 31 27 747 01 0	4014586346960	TCT Ultra 35 core bit with 3/4" Weldon holder	80.36	20	106
6 31 27 748 01 0	4014586346977	TCT Ultra 35 core bit with 3/4" Weldon holder	89.65	20	106
6 31 27 749 01 0	4014586346984	TCT Ultra 35 core bit with 3/4" Weldon holder	89.65	20	106
6 31 27 750 01 0	4014586346991	TCT Ultra 35 core bit with 3/4" Weldon holder	89.65	20	106

Part number	EAN	Description	£ List Price excl, VAT	PC	Page
6 31 27 751 01 0	4014586347004	TCT Ultra 35 core bit with 3/4" Weldon holder	89.65	20	106
6 31 27 752 01 0	4014586347011	TCT Ultra 35 core bit with 3/4" Weldon holder	89.65	20	106
6 31 27 753 01 0	4014586347028	TCT Ultra 35 core bit with 3/4" Weldon holder	99.05	20	106
6 31 27 754 01 0	4014586347035	TCT Ultra 35 core bit with 3/4" Weldon holder	99.05	20	106
6 31 27 755 01 0	4014586347042	TCT Ultra 35 core bit with 3/4" Weldon holder	99.05	20	106
6 31 27 756 01 0	4014586347059	TCT Ultra 35 core bit with 3/4" Weldon holder	99.05	20	106
6 31 27 757 01 0	4014586347066	TCT Ultra 35 core bit with 3/4" Weldon holder	99.05	20	106
6 31 27 758 01 0	4014586347073	TCT Ultra 35 core bit with 3/4" Weldon holder	103.32	20	106
6 31 27 759 01 0	4014586347080	TCT Ultra 35 core bit with 3/4" Weldon holder	103.32	20	106
6 31 27 760 01 0	4014586347097	TCT Ultra 35 core bit with 3/4" Weldon holder	103.32	20	106
6 31 27 761 01 0	4014586347103	TCT Ultra 35 core bit with 3/4" Weldon holder	103.32	20	106
6 31 27 762 01 0	4014586347110	TCT Ultra 35 core bit with 3/4" Weldon holder	106.03	20	106
6 31 27 763 01 0	4014586353265	TCT Ultra core bit with QuickIN holder	76.52	20	112
6 31 27 764 01 0	4014586353272	TCT Ultra core bit with QuickIN holder	76.52	20	112
6 31 27 765 01 0	4014586353289	TCT Ultra core bit with QuickIN holder	76.52	20	112
6 31 27 766 01 0	4014586353296	TCT Ultra core bit with QuickIN holder	76.52	20	112
6 31 27 767 01 0	4014586353302	TCT Ultra core bit with QuickIN holder	72.57	20	112
6 31 27 768 01 0	4014586353319	TCT Ultra core bit with QuickIN holder	76.52	20	112
6 31 27 769 01 0	4014586353326	TCT Ultra core bit with QuickIN holder	76.52	20	112
6 31 27 770 01 0	4014586353333	TCT Ultra core bit with QuickIN holder	76.52	20	112
6 31 27 771 01 0	4014586353340	TCT Ultra core bit with QuickIN holder	72.57	20	112
6 31 27 772 01 0	4014586353357	TCT Ultra core bit with QuickIN holder	76.52	20	112
6 31 27 773 01 0	4014586353364	TCT Ultra core bit with QuickIN holder	76.52	20	112
6 31 27 774 01 0	4014586353371	TCT Ultra core bit with QuickIN holder	84.25	20	112
6 31 27 775 01 0	4014586353388	TCT Ultra core bit with QuickIN holder	84.25	20	112
6 31 27 776 01 0	4014586353395	TCT Ultra core bit with QuickIN holder	84.25	20	112
6 31 27 777 01 0	4014586353401	TCT Ultra core bit with QuickIN holder	84.25	20	112
6 31 27 778 01 0	4014586353418	TCT Ultra core bit with QuickIN holder	93.58	20	112
6 31 27 779 01 0	4014586353425	TCT Ultra core bit with QuickIN holder	93.58	20	112
6 31 27 780 01 0	4014586353432	TCT Ultra core bit with QuickIN holder	105.98	20	112
6 31 27 781 01 0	4014586353449	TCT Ultra core bit with QuickIN holder	115.32	20	112
6 31 27 782 01 0	4014586353456	TCT Ultra core bit with QuickIN holder	124.77	20	112
6 31 27 783 01 0	4014586353463	TCT Ultra core bit with QuickIN holder	129.05	20	112
6 31 27 784 01 0	4014586353470	TCT Ultra core bit with QuickIN holder	142.67	20	112
6 31 27 785 01 0	4014586353487	TCT Ultra 75 core bit with 3/4" Weldon holder	76.52	20	114
6 31 27 786 01 0	4014586353494	TCT Ultra 75 core bit with 3/4" Weldon holder	76.52	20	114
6 31 27 787 01 0	4014586353500	TCT Ultra 75 core bit with 3/4" Weldon holder	72.57	20	114
6 31 27 788 01 0	4014586353517	TCT Ultra 75 core bit with 3/4" Weldon holder	76.52	20	114
6 31 27 789 01 0	4014586353524	TCT Ultra 75 core bit with 3/4" Weldon holder	72.57	20	114
6 31 27 790 01 0	4014586353531	TCT Ultra 75 core bit with 3/4" Weldon holder	76.52	20	114
6 31 27 791 01 0	4014586353548	TCT Ultra 75 core bit with 3/4" Weldon holder	72.57	20	114
6 31 27 792 01 0	4014586353555	TCT Ultra 75 core bit with 3/4" Weldon holder	76.52	20	114
6 31 27 793 01 0	4014586353562	TCT Ultra 75 core bit with 3/4" Weldon holder	72.57	20	114
6 31 27 794 01 0	4014586353579	TCT Ultra 75 core bit with 3/4" Weldon holder	76.52	20	114
6 31 27 795 01 0	4014586353586	TCT Ultra 75 core bit with 3/4" Weldon holder	72.57	20	114
6 31 27 796 01 0	4014586353593	TCT Ultra 75 core bit with 3/4" Weldon holder	84.25	20	114
6 31 27 797 01 0	4014586353609	TCT Ultra 75 core bit with 3/4" Weldon holder	79.91	20	114
6 31 27 798 01 0	4014586353616	TCT Ultra 75 core bit with 3/4" Weldon holder	79.91	20	114
6 31 27 799 01 0	4014586353623	TCT Ultra 75 core bit with 3/4" Weldon holder	79.91	20	114
6 31 27 800 01 0	4014586353630	TCT Ultra 75 core bit with 3/4" Weldon holder	88.74	20	114
6 31 27 801 01 0	4014586353647	TCT Ultra 75 core bit with 3/4" Weldon holder	88.74	20	114
6 31 27 802 01 0	4014586353654	TCT Ultra 75 core bit with 3/4" Weldon holder	100.53	20	114
6 31 27 803 01 0	4014586353661	TCT Ultra 75 core bit with 3/4" Weldon holder	109.40	20	114
6 31 27 804 01 0	4014586353678	TCT Ultra 75 core bit with 3/4" Weldon holder	118.35	20	114
6 31 27 805 01 0	4014586353685	TCT Ultra 75 core bit with 3/4" Weldon holder	129.05	20	114
6 31 27 806 01 0	4014586353692	TCT Ultra 75 core bit with 3/4" Weldon holder	142.67	20	114
6 31 30 014 01 0	4014586331034	Core bit D14/20 HM QIP	48.53	20	97
6 31 30 015 01 0	4014586331041	Core bit D15/20 HM QIP	48.53	20	97
6 31 30 016 01 0	4014586331058	Core bit D16/20 HM QIP	48.53	20	97
6 31 30 017 01 0	4014586331065	Core bit D17/20 HM QIP	48.53	20	97
6 31 30 018 01 0	4014586331072	Core bit D18/20 HM QIP	48.53	20	97
6 31 30 019 01 0	4014586331089	Core bit D19/20 HM QIP	48.53	20	97
6 31 30 020 01 0	4014586331096	Core bit D20/20 HM QIP	48.53	20	97
6 31 30 021 01 0	4014586331102	Core bit D21/20 HM QIP	48.53	20	97
6 31 30 022 01 0	4014586331119	Core bit D22/20 HM QIP	48.53	20	97
6 31 30 023 01 0	4014586331126	Core bit D23/20 HM QIP	48.53	20	97
6 31 30 024 01 0	4014586331133	Core bit D24/20 HM QIP	50.53	20	97
6 31 30 025 01 0	4014586331140	Core bit D25/20 HM QIP	50.53	20	97
6 31 30 026 01 0	4014586331157	Core bit D26/20 HM QIP	50.53	20	97
6 31 30 027 01 0	4014586331164	Core bit D27/20 HM QIP	49.21	20	97
6 31 30 028 01 0	4014586331171	Core bit D28/20 HM QIP	49.21	20	97
6 31 30 029 01 0	4014586331188	Core bit D29/20 HM QIP	52.49	20	97
6 31 30 030 01 0	4014586331195	Core bit D30/20 HM QIP	53.91	20	97
6 31 30 114 01 0	4014586331409	Core bit D14/20 HM QIP	61.84	20	97
6 31 30 115 01 0	4014586331416	Core bit D15/20 HM QIP	61.84	20	97
6 31 30 115 51 0	4014586368986	Carbide core drill bit with QuickIN PLUS holder	58.49	20	-
6 31 30 116 01 0	4014586331423	Core bit D16/20 HM QIP	61.84	20	97

Accessories in numerical order

Part number	EAN	Description	£ List Price excl, VAT	PC	Page
6 31 30 117 01 0	4014586331430	Core bit D17/20 HM QIP	61.84	20	97
6 31 30 117 51 0	4014586368993	Carbide core drill bit with QuickIN PLUS holder	58.49	20	-
6 31 30 118 01 0	4014586331447	Core bit D18/20 HM QIP	65.23	20	97
6 31 30 119 01 0	4014586331454	Core bit D19/20 HM QIP	65.23	20	97
6 31 30 119 51 0	4014586369006	Carbide core drill bit with QuickIN PLUS holder	61.66	20	-
6 31 30 120 01 0	4014586331461	Core bit D20/20 HM QIP	65.23	20	97
6 31 30 121 01 0	4014586331478	Core bit D21/20 HM QIP	65.23	20	97
6 31 30 122 01 0	4014586331485	Core bit D22/20 HM QIP	65.23	20	97
6 31 30 123 01 0	4014586331492	Core bit D23/20 HM QIP	65.23	20	97
6 31 30 124 01 0	4014586331508	Core bit D24/20 HM QIP	69.30	20	97
6 31 30 125 01 0	4014586331515	Core bit D25/20 HM QIP	69.30	20	97
6 31 30 126 01 0	4014586331522	Core bit D26/20 HM QIP	67.47	20	97
6 31 30 127 01 0	4014586331539	Core bit D27/20 HM QIP	67.47	20	97
6 31 30 128 01 0	4014586331546	Core bit D28/20 HM QIP	67.47	20	97
6 31 30 129 01 0	4014586331553	Core bit D29/20 HM QIP	67.47	20	97
6 31 30 130 01 0	4014586331560	Core bit D30/20 HM QIP	67.47	20	97
6 31 31 014 01 0	4014586333274	Carbide hole saw with QuickIN PLUS holder Ø14	37.69	20	98
6 31 31 015 01 0	4014586333281	Carbide hole saw with QuickIN PLUS holder Ø15	36.74	20	98
6 31 31 016 01 0	4014586333298	Carbide hole saw with QuickIN PLUS holder Ø16	37.69	20	98
6 31 31 017 01 0	4014586333304	Carbide hole saw with QuickIN PLUS holder Ø17	36.74	20	98
6 31 31 018 01 0	4014586333311	Carbide hole saw with QuickIN PLUS holder Ø18	36.74	20	98
6 31 31 019 01 0	4014586333328	Carbide hole saw with QuickIN PLUS holder Ø19	36.74	20	98
6 31 31 020 01 0	4014586333335	Carbide hole saw with QuickIN PLUS holder Ø20	42.44	20	98
6 31 31 021 01 0	4014586333922	Carbide hole saw with QuickIN PLUS holder Ø21	41.35	20	98
6 31 31 022 01 0	4014586333342	Carbide hole saw with QuickIN PLUS holder Ø22	41.35	20	98
6 31 31 023 01 0	4014586333939	Carbide hole saw with QuickIN PLUS holder Ø23	41.35	20	98
6 31 31 024 01 0	4014586333359	Carbide hole saw with QuickIN PLUS holder Ø24	42.44	20	98
6 31 31 025 01 0	4014586333366	Carbide hole saw with QuickIN PLUS holder Ø25	41.35	20	98
6 31 31 026 01 0	4014586333373	Carbide hole saw with QuickIN PLUS holder Ø26	41.35	20	98
6 31 31 027 01 0	4014586333380	Carbide hole saw with QuickIN PLUS holder Ø27	41.35	20	98
6 31 31 028 01 0	4014586333946	Carbide hole saw with QuickIN PLUS holder Ø28	42.44	20	98
6 31 31 029 01 0	4014586333397	Carbide hole saw with QuickIN PLUS holder Ø29	44.50	20	98
6 31 31 030 01 0	4014586333403	Carbide hole saw with QuickIN PLUS holder Ø30	44.50	20	98
6 31 31 031 01 0	4014586333953	Carbide hole saw with QuickIN PLUS holder Ø31	47.90	20	98
6 31 31 032 01 0	4014586333410	Carbide hole saw with QuickIN PLUS holder Ø32	49.19	20	98
6 31 31 033 01 0	4014586333427	Carbide hole saw with QuickIN PLUS holder Ø33	47.90	20	98
6 31 31 034 01 0	4014586333960	Carbide hole saw with QuickIN PLUS holder Ø34	51.58	20	98
6 31 31 035 01 0	4014586333434	Carbide hole saw with QuickIN PLUS holder Ø35	51.58	20	98
6 31 31 036 01 0	4014586333977	Carbide hole saw with QuickIN PLUS holder Ø36	56.58	20	98
6 31 31 037 01 0	4014586333441	Carbide hole saw with QuickIN PLUS holder Ø37	56.58	20	98
6 31 31 038 01 0	4014586333458	Carbide hole saw with QuickIN PLUS holder Ø38	58.07	20	98
6 31 31 039 01 0	4014586333984	Carbide hole saw with QuickIN PLUS holder Ø39	56.58	20	98
6 31 31 040 01 0	4014586333465	Carbide hole saw with QuickIN PLUS holder Ø40	56.58	20	98
6 31 31 041 01 0	4014586333991	Carbide hole saw with QuickIN PLUS holder Ø41	56.58	20	98
6 31 31 042 01 0	4014586333472	Carbide hole saw with QuickIN PLUS holder Ø42	56.58	20	98
6 31 31 043 01 0	4014586334004	Carbide hole saw with QuickIN PLUS holder Ø43	62.07	20	98
6 31 31 044 01 0	4014586333489	Carbide hole saw with QuickIN PLUS holder Ø44	63.74	20	98
6 31 31 045 01 0	4014586334011	Carbide hole saw with QuickIN PLUS holder Ø45	62.07	20	98
6 31 31 046 01 0	4014586334028	Carbide hole saw with QuickIN PLUS holder Ø46	62.07	20	98
6 31 31 047 01 0	4014586334035	Carbide hole saw with QuickIN PLUS holder Ø47	62.07	20	98
6 31 31 048 01 0	4014586334042	Carbide hole saw with QuickIN PLUS holder Ø48	66.28	20	98
6 31 31 049 01 0	4014586334059	Carbide hole saw with QuickIN PLUS holder Ø49	66.28	20	98
6 31 31 050 01 0	4014586333496	Carbide hole saw with QuickIN PLUS holder Ø50	66.28	20	98
6 31 31 051 01 0	4014586333502	Carbide hole saw with QuickIN PLUS holder Ø51	66.28	20	98
6 31 31 052 01 0	4014586334066	Carbide hole saw with QuickIN PLUS holder Ø52	66.28	20	98
6 31 31 053 01 0	4014586334073	Carbide hole saw with QuickIN PLUS holder Ø53	68.25	20	98
6 31 31 054 01 0	4014586333519	Carbide hole saw with QuickIN PLUS holder Ø54	70.06	20	98
6 31 31 055 01 0	4014586366470	Carbide hole saw with QuickIN PLUS holder	70.86	20	98
6 31 31 056 01 0	4014586366487	Carbide hole saw with QuickIN PLUS holder	77.07	20	98
6 31 31 057 01 0	4014586366494	Carbide hole saw with QuickIN PLUS holder	83.29	20	98
6 31 31 058 01 0	4014586366500	Carbide hole saw with QuickIN PLUS holder	89.51	20	98
6 31 31 059 01 0	4014586366517	Carbide hole saw with QuickIN PLUS holder	96.96	20	98
6 31 31 060 01 0	4014586366524	Carbide hole saw with QuickIN PLUS holder	104.43	20	98
6 31 31 065 01 0	4014586366531	Carbide hole saw with QuickIN PLUS holder	106.90	20	98
6 31 31 068 01 0	4014586366548	Carbide hole saw with QuickIN PLUS holder	110.65	20	98
6 31 31 070 01 0	4014586366555	Carbide hole saw with QuickIN PLUS holder	115.62	20	98
6 31 31 075 01 0	4014586366562	Carbide hole saw with QuickIN PLUS holder	118.10	20	98
6 31 31 080 01 0	4014586366579	Carbide hole saw with QuickIN PLUS holder	123.07	20	98
6 31 31 421 01 0	4014586333526	Carbide hole saw for pipes with QuickIN PLUS holder Ø21	47.83	20	98
6 31 31 422 01 0	4014586334349	Carbide hole saw for pipes with QuickIN PLUS holder Ø22	47.83	20	98
6 31 31 423 01 0	4014586334356	Carbide hole saw for pipes with QuickIN PLUS holder Ø23	46.59	20	98
6 31 31 424 01 0	4014586334363	Carbide hole saw for pipes with QuickIN PLUS holder Ø24	47.83	20	98
6 31 31 425 01 0	4014586333533	Carbide hole saw for pipes with QuickIN PLUS holder Ø25	46.59	20	98
6 31 31 426 01 0	4014586334370	Carbide hole saw for pipes with QuickIN PLUS holder Ø26	46.59	20	98
6 31 31 427 01 0	4014586333540	Carbide hole saw for pipes with QuickIN PLUS holder Ø27	46.59	20	98
6 31 31 428 01 0	4014586333557	Carbide hole saw for pipes with QuickIN PLUS holder Ø28	47.83	20	98
6 31 31 429 01 0	4014586334387	Carbide hole saw for pipes with QuickIN PLUS holder Ø29	49.86	20	98





Part number	EAN	Description	£ List Price excl, VAT	PC	Page
6 31 31 430 01 0	4014586333564	Carbide hole saw for pipes with QuickIN PLUS holder Ø30	49.86	20	98
6 31 31 431 01 0	4014586334394	Carbide hole saw for pipes with QuickIN PLUS holder Ø31	56.30	20	98
6 31 31 432 01 0	4014586334400	Carbide hole saw for pipes with QuickIN PLUS holder Ø32	57.82	20	98
6 31 31 433 01 0	4014586333571	Carbide hole saw for pipes with QuickIN PLUS holder Ø33	56.30	20	98
6 31 31 434 01 0	4014586334417	Carbide hole saw for pipes with QuickIN PLUS holder Ø34	59.60	20	98
6 31 31 435 01 0	4014586333588	Carbide hole saw for pipes with QuickIN PLUS holder Ø35	59.60	20	98
6 31 31 436 01 0	4014586334424	Carbide hole saw for pipes with QuickIN PLUS holder Ø36	66.81	20	98
6 31 31 437 01 0	4014586333431	Carbide hole saw for pipes with QuickIN PLUS holder Ø37	66.81	20	98
6 31 31 438 01 0	4014586334448	Carbide hole saw for pipes with QuickIN PLUS holder Ø38	68.58	20	98
6 31 31 439 01 0	4014586334455	Carbide hole saw for pipes with QuickIN PLUS holder Ø39	66.81	20	98
6 31 31 440 01 0	4014586333595	Carbide hole saw for pipes with QuickIN PLUS holder Ø40	66.81	20	98
6 31 31 441 01 0	4014586334462	Carbide hole saw for pipes with QuickIN PLUS holder Ø41	75.99	20	98
6 31 31 442 01 0	4014586333601	Carbide hole saw for pipes with QuickIN PLUS holder Ø42	75.99	20	98
6 31 31 443 01 0	4014586334479	Carbide hole saw for pipes with QuickIN PLUS holder Ø43	75.99	20	98
6 31 31 444 01 0	4014586334486	Carbide hole saw for pipes with QuickIN PLUS holder Ø44	75.99	20	98
6 31 31 445 01 0	4014586334493	Carbide hole saw for pipes with QuickIN PLUS holder Ø45	75.99	20	98
6 31 31 446 01 0	4014586334509	Carbide hole saw for pipes with QuickIN PLUS holder Ø46	82.54	20	98
6 31 31 447 01 0	4014586334516	Carbide hole saw for pipes with QuickIN PLUS holder Ø47	82.54	20	98
6 31 31 448 01 0	4014586333618	Carbide hole saw for pipes with QuickIN PLUS holder Ø48	82.54	20	98
6 31 31 449 01 0	4014586334523	Carbide hole saw for pipes with QuickIN PLUS holder Ø49	82.54	20	98
6 31 31 450 01 0	4014586333625	Carbide hole saw for pipes with QuickIN PLUS holder Ø50	82.54	20	98
6 31 31 451 01 0	4014586333632	Carbide hole saw for pipes with QuickIN PLUS holder Ø51	85.19	20	98
6 31 31 452 01 0	4014586334530	Carbide hole saw for pipes with QuickIN PLUS holder Ø52	85.19	20	98
6 31 31 453 01 0	4014586334547	Carbide hole saw for pipes with QuickIN PLUS holder Ø53	85.19	20	98
6 31 31 454 01 0	4014586333649	Carbide hole saw for pipes with QuickIN PLUS holder Ø54	87.47	20	98
6 31 31 455 01 0	4014586366678	Carbide hole saw for pipes with QuickIN PLUS holder	87.02	20	98
6 31 31 456 01 0	4014586366685	Carbide hole saw for pipes with QuickIN PLUS holder	89.51	20	98
6 31 31 457 01 0	4014586366692	Carbide hole saw for pipes with QuickIN PLUS holder	93.23	20	98
6 31 31 458 01 0	4014586366708	Carbide hole saw for pipes with QuickIN PLUS holder	101.94	20	98
6 31 31 459 01 0	4014586366715	Carbide hole saw for pipes with QuickIN PLUS holder	106.90	20	98
6 31 31 460 01 0	4014586366722	Carbide hole saw for pipes with QuickIN PLUS holder	111.88	20	98
6 31 31 465 01 0	4014586366739	Carbide hole saw for pipes with QuickIN PLUS holder	121.83	20	98
6 31 31 468 01 0	4014586366746	Carbide hole saw for pipes with QuickIN PLUS holder	129.28	20	98
6 31 33 119 05 1	4014586611471	HSS-NOVA 25 Annular Cutter Ø 12 x 25 QuickIN	20.93	20	114
6 31 33 119 05 2	4014586611501	HSS-NOVA 50 Annular Cutter Ø 12 x 50 QuickIN	29.34	20	115
6 31 33 120 06 7	4014586615578	HSS-DURA 25 Annular Cutter Ø 12 x 25 QuickIN TIN	30.02	20	116
6 31 33 120 06 8	4014586615639	HSS-DURA 50 Annular Cutter Ø 12 x 50 QuickIN TIN	38.19	20	117
6 31 33 129 05 1	4014586611815	HSS-NOVA 25 Annular Cutter Ø 13 x 25 QuickIN	19.33	20	114
6 31 33 129 05 2	4014586611853	HSS-NOVA 50 Annular Cutter Ø 13 x 50 QuickIN	29.34	20	115
6 31 33 130 06 7	4014586611822	HSS-DURA 25 Annular Cutter Ø 13 x 25 QuickIN TIN	30.02	20	116
6 31 33 130 06 8	4014586611860	HSS-DURA 50 Annular Cutter Ø 13 x 50 QuickIN TIN	38.19	20	117
6 31 33 140 05 1	4014586611891	HSS-NOVA 25 Annular Cutter Ø 14 x 25 QuickIN	20.93	20	114
6 31 33 140 05 2	4014586611938	HSS-NOVA 50 Annular Cutter Ø 14 x 50 QuickIN	29.34	20	115
6 31 33 140 06 7	4014586611907	HSS-DURA 25 Annular Cutter Ø 14 x 25 QuickIN TIN	28.48	20	116
6 31 33 140 06 8	4014586611945	HSS-DURA 50 Annular Cutter Ø 14 x 50 QuickIN TIN	36.24	20	117
6 31 33 150 05 1	4014586612188	HSS-NOVA 25 Annular Cutter Ø 15 x 25 QuickIN	19.33	20	114
6 31 33 150 05 2	4014586612225	HSS-NOVA 50 Annular Cutter Ø 15 x 50 QuickIN	28.59	20	115
6 31 33 150 06 7	4014586612195	HSS-DURA 25 Annular Cutter Ø 15 x 25 QuickIN TIN	30.02	20	116
6 31 33 150 06 8	4014586612232	HSS-DURA 50 Annular Cutter Ø 15 x 50 QuickIN TIN	38.19	20	117
6 31 33 159 05 1	4014586612263	HSS-NOVA 25 Annular Cutter Ø 16 x 25 QuickIN	20.93	20	114
6 31 33 159 05 2	4014586612300	HSS-NOVA 50 Annular Cutter Ø 16 x 50 QuickIN	29.34	20	115
6 31 33 160 06 7	4014586612270	HSS-DURA 25 Annular Cutter Ø 16 x 25 QuickIN TIN	28.48	20	116
6 31 33 160 06 8	4014586612317	HSS-DURA 50 Annular Cutter Ø 16 x 50 QuickIN TIN	38.19	20	117
6 31 33 170 05 1	4014586612485	HSS-NOVA 25 Annular Cutter Ø 17 x 25 QuickIN	22.84	20	114
6 31 33 170 05 2	4014586612522	HSS-NOVA 50 Annular Cutter Ø 17 x 50 QuickIN	31.18	20	115
6 31 33 170 06 7	4014586612492	HSS-DURA 25 Annular Cutter Ø 17 x 25 QuickIN TIN	32.76	20	116
6 31 33 170 06 8	4014586612539	HSS-DURA 50 Annular Cutter Ø 17 x 50 QuickIN TIN	40.95	20	117
6 31 33 180 05 1	4014586612560	HSS-NOVA 25 Annular Cutter Ø 18 x 25 QuickIN	22.84	20	114
6 31 33 180 05 2	4014586612607	HSS-NOVA 50 Annular Cutter Ø 18 x 50 QuickIN	32.02	20	115
6 31 33 180 06 7	4014586612577	HSS-DURA 25 Annular Cutter Ø 18 x 25 QuickIN TIN	31.07	20	116
6 31 33 180 06 8	4014586612614	HSS-DURA 50 Annular Cutter Ø 18 x 50 QuickIN TIN	42.04	20	117
6 31 33 189 05 1	4014586612713	HSS-NOVA 25 Annular Cutter Ø 19 x 25 QuickIN	22.22	20	114
6 31 33 189 05 2	4014586612751	HSS-NOVA 50 Annular Cutter Ø 19 x 50 QuickIN	31.18	20	115
6 31 33 190 06 7	4014586612720	HSS-DURA 25 Annular Cutter Ø 19 x 25 QuickIN TIN	33.63	20	116
6 31 33 190 06 8	4014586612768	HSS-DURA 50 Annular Cutter Ø 19 x 50 QuickIN TIN	40.95	20	117
6 31 33 199 05 2	4014586612904	HSS-NOVA 50 Annular Cutter Ø 20 x 50 QuickIN	34.52	20	115
6 31 33 199 06 3	4014586612874	HSS-NOVA 25 Annular Cutter Ø 20 x 25 QuickIN	26.64	20	114
6 31 33 200 06 7	4014586612867	HSS-DURA 25 Annular Cutter Ø 20 x 25 QuickIN TIN	34.92	20	116
6 31 33 200 06 8	4014586612911	HSS-DURA 50 Annular Cutter Ø 20 x 50 QuickIN TIN	46.41	20	117
6 31 33 210 05 1	4014586613123	HSS-NOVA 25 Annular Cutter Ø 21 x 25 QuickIN	26.64	20	114
6 31 33 210 05 2	4014586613161	HSS-NOVA 50 Annular Cutter Ø 21 x 50 QuickIN	36.40	20	115
6 31 33 210 06 7	4014586613130	HSS-DURA 25 Annular Cutter Ø 21 x 25 QuickIN TIN	36.84	20	116
6 31 33 210 06 8	4014586613178	HSS-DURA 50 Annular Cutter Ø 21 x 50 QuickIN TIN	46.41	20	117
6 31 33 219 05 1	4014586613215	HSS-NOVA 25 Annular Cutter Ø 22 x 25 QuickIN	26.64	20	114
6 31 33 219 05 2	4014586613253	HSS-NOVA 50 Annular Cutter Ø 22 x 50 QuickIN	37.36	20	115
6 31 33 220 06 7	4014586613222	HSS-DURA 25 Annular Cutter Ø 22 x 25 QuickIN TIN	34.92	20	116
6 31 33 220 06 8	4014586613260	HSS-DURA 50 Annular Cutter Ø 22 x 50 QuickIN TIN	47.62	20	117

Part number	EAN	Description	£ List Price excl, VAT	PC	Page
6 31 33 229 05 1	4014586613406	HSS-NOVA 25 Annular Cutter Ø 23 x 25 QuickIN	28.15	20	114
6 31 33 229 05 2	4014586613444	HSS-NOVA 50 Annular Cutter Ø 23 x 50 QuickIN	34.52	20	115
6 31 33 230 06 7	4014586613413	HSS-DURA 25 Annular Cutter Ø 23 x 25 QuickIN TIN	45.03	20	116
6 31 33 230 06 8	4014586613451	HSS-DURA 50 Annular Cutter Ø 23 x 50 QuickIN TIN	54.59	20	117
6 31 33 240 05 1	4014586613499	HSS-NOVA 25 Annular Cutter Ø 24 x 25 QuickIN	29.65	20	114
6 31 33 240 05 2	4014586613536	HSS-NOVA 50 Annular Cutter Ø 24 x 50 QuickIN	39.00	20	115
6 31 33 240 06 7	4014586613505	HSS-DURA 25 Annular Cutter Ø 24 x 25 QuickIN TIN	45.03	20	116
6 31 33 240 06 8	4014586613543	HSS-DURA 50 Annular Cutter Ø 24 x 50 QuickIN TIN	54.59	20	117
6 31 33 250 05 1	4014586613635	HSS-NOVA 25 Annular Cutter Ø 25 x 25 QuickIN	30.44	20	114
6 31 33 250 05 2	4014586613673	HSS-NOVA 50 Annular Cutter Ø 25 x 50 QuickIN	44.20	20	115
6 31 33 250 06 7	4014586613642	HSS-DURA 25 Annular Cutter Ø 25 x 25 QuickIN TIN	45.03	20	116
6 31 33 250 06 8	4014586613680	HSS-DURA 50 Annular Cutter Ø 25 x 50 QuickIN TIN	54.59	20	117
6 31 33 259 05 1	4014586613727	HSS-NOVA 25 Annular Cutter Ø 26 x 25 QuickIN	34.58	20	114
6 31 33 259 05 2	4014586613765	HSS-NOVA 50 Annular Cutter Ø 26 x 50 QuickIN	45.39	20	115
6 31 33 260 06 7	4014586613734	HSS-DURA 25 Annular Cutter Ø 26 x 25 QuickIN TIN	46.59	20	116
6 31 33 260 06 8	4014586613772	HSS-DURA 50 Annular Cutter Ø 26 x 50 QuickIN TIN	61.42	20	117
6 31 33 270 05 1	4014586613819	HSS-NOVA 25 Annular Cutter Ø 27 x 25 QuickIN	34.58	20	114
6 31 33 270 05 2	4014586613857	HSS-NOVA 50 Annular Cutter Ø 27 x 50 QuickIN	41.92	20	115
6 31 33 270 06 7	4014586613826	HSS-DURA 25 Annular Cutter Ø 27 x 25 QuickIN TIN	49.13	20	116
6 31 33 270 06 8	4014586613864	HSS-DURA 50 Annular Cutter Ø 27 x 50 QuickIN TIN	61.42	20	117
6 31 33 279 05 1	4014586613901	HSS-NOVA 25 Annular Cutter Ø 28 x 25 QuickIN	37.05	20	114
6 31 33 279 05 2	4014586613949	HSS-NOVA 50 Annular Cutter Ø 28 x 50 QuickIN	51.98	20	115
6 31 33 280 06 7	4014586613918	HSS-DURA 25 Annular Cutter Ø 28 x 25 QuickIN TIN	53.21	20	116
6 31 33 280 06 8	4014586613956	HSS-DURA 50 Annular Cutter Ø 28 x 50 QuickIN TIN	66.88	20	117
6 31 33 289 05 1	4014586613994	HSS-NOVA 25 Annular Cutter Ø 29 x 25 QuickIN	37.05	20	114
6 31 33 289 05 2	4014586614038	HSS-NOVA 50 Annular Cutter Ø 29 x 50 QuickIN	51.98	20	115
6 31 33 290 06 7	4014586614007	HSS-DURA 25 Annular Cutter Ø 29 x 25 QuickIN TIN	53.21	20	116
6 31 33 290 06 8	4014586614045	HSS-DURA 50 Annular Cutter Ø 29 x 50 QuickIN TIN	66.88	20	117
6 31 33 299 05 1	4014586614229	HSS-NOVA 25 Annular Cutter Ø 30 x 25 QuickIN	37.48	20	114
6 31 33 299 05 2	4014586614267	HSS-NOVA 50 Annular Cutter Ø 30 x 50 QuickIN	51.98	20	115
6 31 33 300 06 7	4014586614236	HSS-DURA 25 Annular Cutter Ø 30 x 25 QuickIN TIN	58.67	20	116
6 31 33 300 06 8	4014586614274	HSS-DURA 50 Annular Cutter Ø 30 x 50 QuickIN TIN	73.69	20	117
6 31 33 309 05 1	4014586614311	HSS-NOVA 25 Annular Cutter Ø 31 x 25 QuickIN	39.52	20	114
6 31 33 309 05 2	4014586614359	HSS-NOVA 50 Annular Cutter Ø 31 x 50 QuickIN	58.49	20	115
6 31 33 310 06 7	4014586614328	HSS-DURA 25 Annular Cutter Ø 31 x 25 QuickIN TIN	58.67	20	116
6 31 33 310 06 8	4014586614366	HSS-DURA 50 Annular Cutter Ø 31 x 50 QuickIN TIN	73.69	20	117
6 31 33 319 05 1	4014586614397	HSS-NOVA 25 Annular Cutter Ø 32 x 25 QuickIN	43.34	20	114
6 31 33 319 05 2	4014586614434	HSS-NOVA 50 Annular Cutter Ø 32 x 50 QuickIN	58.49	20	115
6 31 33 320 06 7	4014586614403	HSS-DURA 25 Annular Cutter Ø 32 x 25 QuickIN TIN	63.47	20	116
6 31 33 320 06 8	4014586614441	HSS-DURA 50 Annular Cutter Ø 32 x 50 QuickIN TIN	83.25	20	117
6 31 33 329 05 1	4014586614489	HSS-NOVA 25 Annular Cutter Ø 33 x 25 QuickIN	45.68	20	114
6 31 33 329 05 2	4014586614526	HSS-NOVA 50 Annular Cutter Ø 33 x 50 QuickIN	66.70	20	115
6 31 33 330 06 7	4014586614496	HSS-DURA 25 Annular Cutter Ø 33 x 25 QuickIN TIN	66.88	20	116
6 31 33 330 06 8	4014586614533	HSS-DURA 50 Annular Cutter Ø 33 x 50 QuickIN TIN	83.25	20	117
6 31 33 339 05 1	4014586614564	HSS-NOVA 25 Annular Cutter Ø 34 x 25 QuickIN	51.84	20	114
6 31 33 339 05 2	4014586614601	HSS-NOVA 50 Annular Cutter Ø 34 x 50 QuickIN	61.67	20	115
6 31 33 340 06 7	4014586614571	HSS-DURA 25 Annular Cutter Ø 34 x 25 QuickIN TIN	73.69	20	116
6 31 33 340 06 8	4014586614618	HSS-DURA 50 Annular Cutter Ø 34 x 50 QuickIN TIN	92.78	20	117
6 31 33 350 05 1	4014586614649	HSS-NOVA 25 Annular Cutter Ø 35 x 25 QuickIN	51.84	20	115
6 31 33 350 05 2	4014586614687	HSS-NOVA 50 Annular Cutter Ø 35 x 50 QuickIN	65.00	20	115
6 31 33 350 06 7	4014586614656	HSS-DURA 25 Annular Cutter Ø 35 x 25 QuickIN TIN	73.69	20	116
6 31 33 350 06 8	4014586614694	HSS-DURA 50 Annular Cutter Ø 35 x 50 QuickIN TIN	92.78	20	117
6 31 33 359 05 1	4014586614731	HSS-NOVA 25 Annular Cutter Ø 36 x 25 QuickIN	51.84	20	115
6 31 33 359 05 2	4014586614779	HSS-NOVA 50 Annular Cutter Ø 36 x 50 QuickIN	74.09	20	115
6 31 33 360 06 7	4014586614748	HSS-DURA 25 Annular Cutter Ø 36 x 25 QuickIN TIN	73.69	20	116
6 31 33 360 06 8	4014586614786	HSS-DURA 50 Annular Cutter Ø 36 x 50 QuickIN TIN	92.78	20	117
6 31 33 369 05 1	4014586614823	HSS-NOVA 25 Annular Cutter Ø 37 x 25 QuickIN	60.49	20	115
6 31 33 369 05 2	4014586614861	HSS-NOVA 50 Annular Cutter Ø 37 x 50 QuickIN	74.09	20	115
6 31 33 370 06 7	4014586614830	HSS-DURA 25 Annular Cutter Ø 37 x 25 QuickIN TIN	83.25	20	116
6 31 33 370 06 8	4014586614878	HSS-DURA 50 Annular Cutter Ø 37 x 50 QuickIN TIN	103.72	20	117
6 31 33 379 05 1	4014586614908	HSS-NOVA 25 Annular Cutter Ø 38 x 25 QuickIN	60.49	20	115
6 31 33 379 05 2	4014586614946	HSS-NOVA 50 Annular Cutter Ø 38 x 50 QuickIN	74.09	20	115
6 31 33 380 06 7	4014586614915	HSS-DURA 25 Annular Cutter Ø 38 x 25 QuickIN TIN	83.25	20	116
6 31 33 380 06 8	4014586614953	HSS-DURA 50 Annular Cutter Ø 38 x 50 QuickIN TIN	103.72	20	117
6 31 33 389 05 1	4014586614984	HSS-NOVA 25 Annular Cutter Ø 39 x 25 QuickIN	60.49	20	115
6 31 33 389 05 2	4014586615028	HSS-NOVA 50 Annular Cutter Ø 39 x 50 QuickIN	84.49	20	115
6 31 33 390 06 7	4014586614991	HSS-DURA 25 Annular Cutter Ø 39 x 25 QuickIN TIN	83.25	20	116
6 31 33 390 06 8	4014586615035	HSS-DURA 50 Annular Cutter Ø 39 x 50 QuickIN TIN	103.72	20	117
6 31 33 399 05 1	4014586615066	HSS-NOVA 25 Annular Cutter Ø 40 x 25 QuickIN	67.91	20	115
6 31 33 399 05 2	4014586615103	HSS-NOVA 50 Annular Cutter Ø 40 x 50 QuickIN	84.49	20	115
6 31 33 400 06 7	4014586615073	HSS-DURA 25 Annular Cutter Ø 40 x 25 QuickIN TIN	92.78	20	116
6 31 33 400 06 8	4014586615110	HSS-DURA 50 Annular Cutter Ø 40 x 50 QuickIN TIN	115.99	20	117
6 31 33 409 05 1	4014586615158	HSS-NOVA 25 Annular Cutter Ø 41 x 25 QuickIN	67.91	20	115
6 31 33 409 05 2	4014586615196	HSS-NOVA 50 Annular Cutter Ø 41 x 50 QuickIN	90.97	20	115
6 31 33 410 06 7	4014586615165	HSS-DURA 25 Annular Cutter Ø 41 x 25 QuickIN TIN	92.78	20	116
6 31 33 410 06 8	4014586615202	HSS-DURA 50 Annular Cutter Ø 41 x 50 QuickIN TIN	115.99	20	117
6 31 33 420 05 1	4014586615233	HSS-NOVA 25 Annular Cutter Ø 42 x 25 QuickIN	74.09	20	115



Part number	EAN	Description	£ List Price excl. VAT	PC	Page
6 31 33 420 05 2	4014586615271	HSS-NOVA 50 Annular Cutter Ø 42 x 50 QuickIN	98.77	20	115
6 31 33 420 06 7	4014586615240	HSS-DURA 25 Annular Cutter Ø 42 x 25 QuickIN TIN	100.99	20	116
6 31 33 420 06 8	4014586615288	HSS-DURA 50 Annular Cutter Ø 42 x 50 QuickIN TIN	126.90	20	117
6 31 33 429 05 1	4014586615318	HSS-NOVA 25 Annular Cutter Ø 43 x 25 QuickIN	74.09	20	115
6 31 33 429 05 2	4014586615356	HSS-NOVA 50 Annular Cutter Ø 43 x 50 QuickIN	98.77	20	115
6 31 33 430 06 7	4014586615325	HSS-DURA 25 Annular Cutter Ø 43 x 25 QuickIN TIN	100.99	20	116
6 31 33 430 06 8	4014586615363	HSS-DURA 50 Annular Cutter Ø 43 x 50 QuickIN TIN	126.90	20	117
6 31 33 439 05 1	4014586615394	HSS-NOVA 25 Annular Cutter Ø 44 x 25 QuickIN	77.79	20	115
6 31 33 439 05 2	4014586615431	HSS-NOVA 50 Annular Cutter Ø 44 x 50 QuickIN	98.77	20	115
6 31 33 440 06 7	4014586615400	HSS-DURA 25 Annular Cutter Ø 44 x 25 QuickIN TIN	107.79	20	116
6 31 33 440 06 8	4014586615448	HSS-DURA 50 Annular Cutter Ø 44 x 50 QuickIN TIN	136.47	20	117
6 31 33 449 05 1	4014586615479	HSS-NOVA 25 Annular Cutter Ø 45 x 25 QuickIN	77.79	20	115
6 31 33 449 05 2	4014586615516	HSS-NOVA 50 Annular Cutter Ø 45 x 50 QuickIN	103.98	20	115
6 31 33 450 06 7	4014586615486	HSS-DURA 25 Annular Cutter Ø 45 x 25 QuickIN TIN	107.79	20	116
6 31 33 450 06 8	4014586615523	HSS-DURA 50 Annular Cutter Ø 45 x 50 QuickIN TIN	136.47	20	117
6 31 33 459 05 1	4014586615561	HSS-NOVA 25 Annular Cutter Ø 46 x 25 QuickIN	88.91	20	115
6 31 33 459 05 2	4014586615622	HSS-NOVA 50 Annular Cutter Ø 46 x 50 QuickIN	114.37	20	115
6 31 33 460 06 7	4014586615585	HSS-DURA 25 Annular Cutter Ø 46 x 25 QuickIN TIN	120.08	20	116
6 31 33 460 06 8	4014586615646	HSS-DURA 50 Annular Cutter Ø 46 x 50 QuickIN TIN	152.86	20	117
6 31 33 469 05 1	4014586615684	HSS-NOVA 25 Annular Cutter Ø 47 x 25 QuickIN	88.91	20	115
6 31 33 469 05 2	4014586615721	HSS-NOVA 50 Annular Cutter Ø 47 x 50 QuickIN	114.37	20	115
6 31 33 470 06 7	4014586615691	HSS-DURA 25 Annular Cutter Ø 47 x 25 QuickIN TIN	120.08	20	116
6 31 33 470 06 8	4014586615738	HSS-DURA 50 Annular Cutter Ø 47 x 50 QuickIN TIN	152.86	20	117
6 31 33 479 05 1	4014586615769	HSS-NOVA 25 Annular Cutter Ø 48 x 25 QuickIN	92.60	20	115
6 31 33 479 05 2	4014586615806	HSS-NOVA 50 Annular Cutter Ø 48 x 50 QuickIN	119.57	20	115
6 31 33 480 06 7	4014586615776	HSS-DURA 25 Annular Cutter Ø 48 x 25 QuickIN TIN	131.01	20	116
6 31 33 480 06 8	4014586615813	HSS-DURA 50 Annular Cutter Ø 48 x 50 QuickIN TIN	163.76	20	117
6 31 33 489 05 1	4014586615844	HSS-NOVA 25 Annular Cutter Ø 49 x 25 QuickIN	92.60	20	115
6 31 33 489 05 2	4014586615882	HSS-NOVA 50 Annular Cutter Ø 49 x 50 QuickIN	119.57	20	115
6 31 33 490 06 7	4014586615851	HSS-DURA 25 Annular Cutter Ø 49 x 25 QuickIN TIN	131.01	20	116
6 31 33 490 06 8	4014586615899	HSS-DURA 50 Annular Cutter Ø 49 x 50 QuickIN TIN	163.76	20	117
6 31 33 499 05 1	4014586615981	HSS-NOVA 25 Annular Cutter Ø 50 x 25 QuickIN	92.60	20	115
6 31 33 499 05 2	4014586616018	HSS-NOVA 50 Annular Cutter Ø 50 x 50 QuickIN	126.76	20	115
6 31 33 500 06 7	4014586615592	HSS-DURA 25 Annular Cutter Ø 50 x 25 QuickIN TIN	131.01	20	116
6 31 33 500 06 8	4014586615653	HSS-DURA 50 Annular Cutter Ø 50 x 50 QuickIN TIN	163.76	20	117
6 31 33 999 01 0	4014586375571	Best of core bits HSS NOVA 50 QI 12,14,16,18,20,22 mm accessory set	190.16	20	114
6 31 34 120 05 1	4014586611457	HSS-NOVA 25 Annular Cutter Ø 12 x 25 Weldon	20.93	20	103
6 31 34 120 05 2	4014586611488	HSS-NOVA 50 Annular Cutter Ø 12 x 50 Weldon	29.34	20	104
6 31 34 120 07 5	4014586611464	HSS-DURA 25 Annular Cutter Ø 12 x 25 Weldon TIN	30.02	20	105
6 31 34 120 07 6	4014586611495	HSS-DURA 50 Annular Cutter Ø 12 x 50 Weldon TIN	36.24	20	105
6 31 34 130 05 1	4014586611792	HSS-NOVA 25 Annular Cutter Ø 13 x 25 Weldon	19.33	20	103
6 31 34 130 05 2	4014586611839	HSS-NOVA 50 Annular Cutter Ø 13 x 50 Weldon	27.10	20	104
6 31 34 130 07 5	4014586611808	HSS-DURA 25 Annular Cutter Ø 13 x 25 Weldon TIN	30.02	20	105
6 31 34 130 07 6	4014586611846	HSS-DURA 50 Annular Cutter Ø 13 x 50 Weldon TIN	36.24	20	105
6 31 34 140 05 1	4014586611877	HSS-NOVA 25 Annular Cutter Ø 14 x 25 Weldon	20.93	20	103
6 31 34 140 05 2	4014586611914	HSS-NOVA 50 Annular Cutter Ø 14 x 50 Weldon	29.34	20	104
6 31 34 140 07 5	4014586611884	HSS-DURA 25 Annular Cutter Ø 14 x 25 Weldon TIN	30.82	20	105
6 31 34 140 07 6	4014586611921	HSS-DURA 50 Annular Cutter Ø 14 x 50 Weldon TIN	39.25	20	105
6 31 34 150 05 1	4014586612164	HSS-NOVA 25 Annular Cutter Ø 15 x 25 Weldon	19.33	20	103
6 31 34 150 05 2	4014586612201	HSS-NOVA 50 Annular Cutter Ø 15 x 50 Weldon	27.10	20	104
6 31 34 150 07 5	4014586612171	HSS-DURA 25 Annular Cutter Ø 15 x 25 Weldon TIN	30.02	20	105
6 31 34 150 07 6	4014586612218	HSS-DURA 50 Annular Cutter Ø 15 x 50 Weldon TIN	36.24	20	105
6 31 34 160 05 1	4014586612249	HSS-NOVA 25 Annular Cutter Ø 16 x 25 Weldon	20.93	20	103
6 31 34 160 05 2	4014586612287	HSS-NOVA 50 Annular Cutter Ø 16 x 50 Weldon	29.34	20	104
6 31 34 160 07 5	4014586612256	HSS-DURA 25 Annular Cutter Ø 16 x 25 Weldon TIN	30.82	20	105
6 31 34 160 07 6	4014586612294	HSS-DURA 50 Annular Cutter Ø 16 x 50 Weldon TIN	36.24	20	105
6 31 34 170 05 1	4014586612461	HSS-NOVA 25 Annular Cutter Ø 17 x 25 Weldon	22.84	20	103
6 31 34 170 05 2	4014586612508	HSS-NOVA 50 Annular Cutter Ø 17 x 50 Weldon	29.58	20	104
6 31 34 170 07 5	4014586612478	HSS-DURA 25 Annular Cutter Ø 17 x 25 Weldon TIN	32.76	20	105
6 31 34 170 07 6	4014586612515	HSS-DURA 50 Annular Cutter Ø 17 x 50 Weldon TIN	38.82	20	105
6 31 34 180 05 1	4014586612546	HSS-NOVA 25 Annular Cutter Ø 18 x 25 Weldon	22.84	20	103
6 31 34 180 05 2	4014586612584	HSS-NOVA 50 Annular Cutter Ø 18 x 50 Weldon	32.02	20	104
6 31 34 180 07 5	4014586612553	HSS-DURA 25 Annular Cutter Ø 18 x 25 Weldon TIN	31.07	20	105
6 31 34 180 07 6	4014586612591	HSS-DURA 50 Annular Cutter Ø 18 x 50 Weldon TIN	42.04	20	105
6 31 34 190 05 1	4014586612690	HSS-NOVA 25 Annular Cutter Ø 19 x 25 Weldon	21.06	20	103
6 31 34 190 05 2	4014586612737	HSS-NOVA 50 Annular Cutter Ø 19 x 50 Weldon	29.58	20	104
6 31 34 190 05 3	4014586612775	HSS-NOVA 75 Annular Cutter Ø 19 x 75 Weldon	68.74	20	104
6 31 34 190 07 5	4014586612706	HSS-DURA 25 Annular Cutter Ø 19 x 25 Weldon TIN	32.76	20	105
6 31 34 190 07 6	4014586612744	HSS-DURA 50 Annular Cutter Ø 19 x 50 Weldon TIN	38.82	20	105
6 31 34 200 05 1	4014586612843	HSS-NOVA 25 Annular Cutter Ø 20 x 25 Weldon	26.64	20	103
6 31 34 200 05 2	4014586612881	HSS-NOVA 50 Annular Cutter Ø 20 x 50 Weldon	37.36	20	104
6 31 34 200 05 3	4014586612928	HSS-NOVA 75 Annular Cutter Ø 20 x 75 Weldon	68.74	20	104
6 31 34 200 07 5	4014586612850	HSS-DURA 25 Annular Cutter Ø 20 x 25 Weldon TIN	36.84	20	105
6 31 34 200 07 6	4014586612898	HSS-DURA 50 Annular Cutter Ø 20 x 50 Weldon TIN	47.62	20	105
6 31 34 210 05 1	4014586613109	HSS-NOVA 25 Annular Cutter Ø 21 x 25 Weldon	26.64	20	104
6 31 34 210 05 2	4014586613147	HSS-NOVA 50 Annular Cutter Ø 21 x 50 Weldon	34.52	20	104
6 31 34 210 05 3	4014586613185	HSS-NOVA 75 Annular Cutter Ø 21 x 75 Weldon	72.29	20	104

Accessories in numerical order

Part number	EAN	Description	£ List Price excl, VAT	PC	Page
6 31 34 210 07 5	4014586613116	HSS-DURA 25 Annular Cutter Ø 21 x 25 Weldon TIN	36.84	20	105
6 31 34 210 07 6	4014586613154	HSS-DURA 50 Annular Cutter Ø 21 x 50 Weldon TIN	44.02	20	105
6 31 34 220 05 1	4014586613192	HSS-NOVA 25 Annular Cutter Ø 22 x 25 Weldon	26.64	20	104
6 31 34 220 05 2	4014586613239	HSS-NOVA 50 Annular Cutter Ø 22 x 25 Weldon	37.36	20	104
6 31 34 220 05 3	4014586613277	HSS-NOVA 75 Annular Cutter Ø 22 x 75 Weldon	74.21	20	104
6 31 34 220 07 5	4014586613208	HSS-DURA 25 Annular Cutter Ø 22 x 25 Weldon TIN	34.92	20	105
6 31 34 220 07 6	4014586613246	HSS-DURA 50 Annular Cutter Ø 22 x 50 Weldon TIN	47.62	20	105
6 31 34 230 05 1	4014586613383	HSS-NOVA 25 Annular Cutter Ø 23 x 25 Weldon	28.15	20	104
6 31 34 230 05 2	4014586613420	HSS-NOVA 50 Annular Cutter Ø 23 x 50 Weldon	34.52	20	104
6 31 34 230 05 3	4014586613468	HSS-NOVA 75 Annular Cutter Ø 23 x 75 Weldon	72.29	20	104
6 31 34 230 07 5	4014586613390	HSS-DURA 25 Annular Cutter Ø 23 x 25 Weldon TIN	45.03	20	105
6 31 34 230 07 6	4014586613437	HSS-DURA 50 Annular Cutter Ø 23 x 50 Weldon TIN	51.80	20	105
6 31 34 240 05 1	4014586613475	HSS-NOVA 25 Annular Cutter Ø 24 x 25 Weldon	30.44	20	104
6 31 34 240 05 2	4014586613512	HSS-NOVA 50 Annular Cutter Ø 24 x 50 Weldon	40.07	20	104
6 31 34 240 05 3	4014586613550	HSS-NOVA 75 Annular Cutter Ø 24 x 75 Weldon	74.21	20	104
6 31 34 240 07 5	4014586613482	HSS-DURA 25 Annular Cutter Ø 24 x 25 Weldon TIN	45.03	20	105
6 31 34 240 07 6	4014586613529	HSS-DURA 50 Annular Cutter Ø 24 x 50 Weldon TIN	51.80	20	105
6 31 34 250 05 1	4014586613611	HSS-NOVA 25 Annular Cutter Ø 25 x 25 Weldon	30.44	20	104
6 31 34 250 05 2	4014586613659	HSS-NOVA 50 Annular Cutter Ø 25 x 50 Weldon	41.92	20	104
6 31 34 250 05 3	4014586613697	HSS-NOVA 75 Annular Cutter Ø 25 x 75 Weldon	84.34	20	104
6 31 34 250 07 5	4014586613628	HSS-DURA 25 Annular Cutter Ø 25 x 25 Weldon TIN	45.03	20	105
6 31 34 250 07 6	4014586613666	HSS-DURA 50 Annular Cutter Ø 25 x 50 Weldon TIN	51.80	20	105
6 31 34 260 05 1	4014586613703	HSS-NOVA 25 Annular Cutter Ø 26 x 25 Weldon	35.53	20	104
6 31 34 260 05 2	4014586613741	HSS-NOVA 50 Annular Cutter Ø 26 x 50 Weldon	45.39	20	104
6 31 34 260 05 3	4014586613789	HSS-NOVA 75 Annular Cutter Ø 26 x 75 Weldon	86.61	20	104
6 31 34 260 07 5	4014586613710	HSS-DURA 25 Annular Cutter Ø 26 x 25 Weldon TIN	50.45	20	105
6 31 34 260 07 6	4014586613758	HSS-DURA 50 Annular Cutter Ø 26 x 50 Weldon TIN	58.26	20	105
6 31 34 270 05 1	4014586613796	HSS-NOVA 25 Annular Cutter Ø 27 x 25 Weldon	32.82	20	104
6 31 34 270 05 2	4014586613833	HSS-NOVA 50 Annular Cutter Ø 27 x 50 Weldon	41.92	20	104
6 31 34 270 05 3	4014586613871	HSS-NOVA 75 Annular Cutter Ø 27 x 75 Weldon	84.34	20	104
6 31 34 270 07 5	4014586613802	HSS-DURA 25 Annular Cutter Ø 27 x 25 Weldon TIN	49.13	20	105
6 31 34 270 07 6	4014586613840	HSS-DURA 50 Annular Cutter Ø 27 x 50 Weldon TIN	58.26	20	105
6 31 34 280 05 1	4014586613888	HSS-NOVA 25 Annular Cutter Ø 28 x 25 Weldon	38.03	20	104
6 31 34 280 05 2	4014586613925	HSS-NOVA 50 Annular Cutter Ø 28 x 50 Weldon	53.37	20	104
6 31 34 280 05 3	4014586613963	HSS-NOVA 75 Annular Cutter Ø 28 x 75 Weldon	96.25	20	104
6 31 34 280 07 5	4014586613895	HSS-DURA 25 Annular Cutter Ø 28 x 25 Weldon TIN	53.21	20	105
6 31 34 280 07 6	4014586613932	HSS-DURA 50 Annular Cutter Ø 28 x 50 Weldon TIN	63.47	20	105
6 31 34 290 05 1	4014586613970	HSS-NOVA 25 Annular Cutter Ø 29 x 25 Weldon	35.14	20	104
6 31 34 290 05 2	4014586614014	HSS-NOVA 50 Annular Cutter Ø 29 x 50 Weldon	49.27	20	104
6 31 34 290 05 3	4014586614052	HSS-NOVA 75 Annular Cutter Ø 29 x 75 Weldon	93.72	20	104
6 31 34 290 07 5	4014586613987	HSS-DURA 25 Annular Cutter Ø 29 x 25 Weldon TIN	53.21	20	105
6 31 34 290 07 6	4014586614021	HSS-DURA 50 Annular Cutter Ø 29 x 50 Weldon TIN	63.47	20	105
6 31 34 300 05 1	4014586614205	HSS-NOVA 25 Annular Cutter Ø 30 x 25 Weldon	40.57	20	104
6 31 34 300 05 2	4014586614243	HSS-NOVA 50 Annular Cutter Ø 30 x 50 Weldon	53.37	20	104
6 31 34 300 05 3	4014586614281	HSS-NOVA 75 Annular Cutter Ø 30 x 75 Weldon	111.38	20	104
6 31 34 300 07 5	4014586614212	HSS-DURA 25 Annular Cutter Ø 30 x 25 Weldon TIN	58.67	20	105
6 31 34 300 07 6	4014586614250	HSS-DURA 50 Annular Cutter Ø 30 x 50 Weldon TIN	69.89	20	105
6 31 34 310 05 1	4014586614298	HSS-NOVA 25 Annular Cutter Ø 31 x 25 Weldon	37.48	20	104
6 31 34 310 05 2	4014586614335	HSS-NOVA 50 Annular Cutter Ø 31 x 50 Weldon	55.50	20	104
6 31 34 310 07 5	4014586614304	HSS-DURA 25 Annular Cutter Ø 31 x 25 Weldon TIN	58.67	20	105
6 31 34 310 07 6	4014586614342	HSS-DURA 50 Annular Cutter Ø 31 x 50 Weldon TIN	69.89	20	105
6 31 34 320 05 1	4014586614373	HSS-NOVA 25 Annular Cutter Ø 32 x 25 Weldon	46.92	20	104
6 31 34 320 05 2	4014586614410	HSS-NOVA 50 Annular Cutter Ø 32 x 50 Weldon	55.50	20	104
6 31 34 320 05 3	4014586614458	HSS-NOVA 75 Annular Cutter Ø 32 x 75 Weldon	111.38	20	104
6 31 34 320 07 5	4014586614380	HSS-DURA 25 Annular Cutter Ø 32 x 25 Weldon TIN	66.88	20	105
6 31 34 320 07 6	4014586614427	HSS-DURA 50 Annular Cutter Ø 32 x 50 Weldon TIN	78.95	20	105
6 31 34 330 05 1	4014586614465	HSS-NOVA 25 Annular Cutter Ø 33 x 25 Weldon	43.34	20	104
6 31 34 330 05 2	4014586614502	HSS-NOVA 50 Annular Cutter Ø 33 x 50 Weldon	61.67	20	104
6 31 34 330 07 5	4014586614472	HSS-DURA 25 Annular Cutter Ø 33 x 25 Weldon TIN	66.88	20	105
6 31 34 330 07 6	4014586614519	HSS-DURA 50 Annular Cutter Ø 33 x 50 Weldon TIN	85.48	20	105
6 31 34 340 05 1	4014586614540	HSS-NOVA 25 Annular Cutter Ø 34 x 25 Weldon	49.18	20	104
6 31 34 340 05 2	4014586614588	HSS-NOVA 50 Annular Cutter Ø 34 x 50 Weldon	61.67	20	104
6 31 34 340 07 5	4014586614557	HSS-DURA 25 Annular Cutter Ø 34 x 25 Weldon TIN	69.89	20	105
6 31 34 340 07 6	4014586614595	HSS-DURA 50 Annular Cutter Ø 34 x 50 Weldon TIN	88.02	20	105
6 31 34 350 05 1	4014586614625	HSS-NOVA 25 Annular Cutter Ø 35 x 25 Weldon	49.18	20	104
6 31 34 350 05 2	4014586614663	HSS-NOVA 50 Annular Cutter Ø 35 x 50 Weldon	61.67	20	104
6 31 34 350 05 3	4014586614700	HSS-NOVA 75 Annular Cutter Ø 35 x 75 Weldon	116.46	20	104
6 31 34 350 07 5	4014586614632	HSS-DURA 25 Annular Cutter Ø 35 x 25 Weldon TIN	73.69	20	105
6 31 34 350 07 6	4014586614670	HSS-DURA 50 Annular Cutter Ø 35 x 50 Weldon TIN	88.02	20	105
6 31 34 360 05 1	4014586614717	HSS-NOVA 25 Annular Cutter Ø 36 x 25 Weldon	51.84	20	104
6 31 34 360 05 2	4014586614755	HSS-NOVA 50 Annular Cutter Ø 36 x 50 Weldon	70.26	20	104
6 31 34 360 05 3	4014586614793	HSS-NOVA 75 Annular Cutter Ø 36 x 75 Weldon	129.21	20	104
6 31 34 360 07 5	4014586614724	HSS-DURA 25 Annular Cutter Ø 36 x 25 Weldon TIN	73.69	20	105
6 31 34 360 07 6	4014586614762	HSS-DURA 50 Annular Cutter Ø 36 x 50 Weldon TIN	88.02	20	105
6 31 34 370 05 1	4014586614809	HSS-NOVA 25 Annular Cutter Ø 37 x 25 Weldon	60.49	20	104
6 31 34 370 05 2	4014586614847	HSS-NOVA 50 Annular Cutter Ø 37 x 50 Weldon	70.26	20	104
6 31 34 370 07 5	4014586614816	HSS-DURA 25 Annular Cutter Ø 37 x 25 Weldon TIN	83.25	20	105



Part number	EAN	Description	£ List Price excl. VAT	PC	Page
6 31 34 370 07 6	4014586614854	HSS-DURA 50 Annular Cutter Ø 37 x 50 Weldon TIN	98.39	20	105
6 31 34 380 05 1	4014586614885	HSS-NOVA 25 Annular Cutter Ø 38 x 25 Weldon	57.36	20	104
6 31 34 380 05 2	4014586614922	HSS-NOVA 50 Annular Cutter Ø 38 x 50 Weldon	76.08	20	104
6 31 34 380 07 5	4014586614892	HSS-DURA 25 Annular Cutter Ø 38 x 25 Weldon TIN	83.25	20	105
6 31 34 380 07 6	4014586614939	HSS-DURA 50 Annular Cutter Ø 38 x 50 Weldon TIN	98.39	20	105
6 31 34 390 05 1	4014586614960	HSS-NOVA 25 Annular Cutter Ø 39 x 25 Weldon	60.49	20	104
6 31 34 390 05 2	4014586615004	HSS-NOVA 50 Annular Cutter Ø 39 x 50 Weldon	80.12	20	104
6 31 34 390 07 5	4014586614977	HSS-DURA 25 Annular Cutter Ø 39 x 25 Weldon TIN	83.25	20	105
6 31 34 390 07 6	4014586615011	HSS-DURA 50 Annular Cutter Ø 39 x 50 Weldon TIN	98.39	20	105
6 31 34 400 05 1	4014586615042	HSS-NOVA 25 Annular Cutter Ø 40 x 25 Weldon	67.91	20	104
6 31 34 400 05 2	4014586615080	HSS-NOVA 50 Annular Cutter Ø 40 x 50 Weldon	80.12	20	104
6 31 34 400 05 3	4014586615127	HSS-NOVA 75 Annular Cutter Ø 40 x 75 Weldon	158.07	20	104
6 31 34 400 07 5	4014586615059	HSS-DURA 25 Annular Cutter Ø 40 x 25 Weldon TIN	92.78	20	105
6 31 34 400 07 6	4014586615097	HSS-DURA 50 Annular Cutter Ø 40 x 50 Weldon TIN	110.03	20	105
6 31 34 410 05 1	4014586615134	HSS-NOVA 25 Annular Cutter Ø 41 x 25 Weldon	67.91	20	104
6 31 34 410 05 2	4014586615172	HSS-NOVA 50 Annular Cutter Ø 41 x 50 Weldon	86.29	20	104
6 31 34 410 07 5	4014586615141	HSS-DURA 25 Annular Cutter Ø 41 x 25 Weldon TIN	92.78	20	105
6 31 34 410 07 6	4014586615189	HSS-DURA 50 Annular Cutter Ø 41 x 50 Weldon TIN	110.03	20	105
6 31 34 420 05 1	4014586615219	HSS-NOVA 25 Annular Cutter Ø 42 x 25 Weldon	74.09	20	104
6 31 34 420 05 2	4014586615257	HSS-NOVA 50 Annular Cutter Ø 42 x 50 Weldon	93.70	20	104
6 31 34 420 07 5	4014586615226	HSS-DURA 25 Annular Cutter Ø 42 x 25 Weldon TIN	100.99	20	105
6 31 34 420 07 6	4014586615264	HSS-DURA 50 Annular Cutter Ø 42 x 50 Weldon TIN	120.38	20	105
6 31 34 430 05 1	4014586615295	HSS-NOVA 25 Annular Cutter Ø 43 x 25 Weldon	74.09	20	104
6 31 34 430 05 2	4014586615332	HSS-NOVA 50 Annular Cutter Ø 43 x 50 Weldon	93.70	20	104
6 31 34 430 07 5	4014586615301	HSS-DURA 25 Annular Cutter Ø 43 x 25 Weldon TIN	100.99	20	105
6 31 34 430 07 6	4014586615349	HSS-DURA 50 Annular Cutter Ø 43 x 50 Weldon TIN	120.38	20	105
6 31 34 440 05 1	4014586615370	HSS-NOVA 25 Annular Cutter Ø 44 x 25 Weldon	77.79	20	104
6 31 34 440 05 2	4014586615417	HSS-NOVA 50 Annular Cutter Ø 44 x 50 Weldon	93.70	20	104
6 31 34 440 07 5	4014586615387	HSS-DURA 25 Annular Cutter Ø 44 x 25 Weldon TIN	107.79	20	105
6 31 34 440 07 6	4014586615424	HSS-DURA 50 Annular Cutter Ø 44 x 50 Weldon TIN	129.47	20	105
6 31 34 450 05 1	4014586615455	HSS-NOVA 25 Annular Cutter Ø 45 x 25 Weldon	73.79	20	104
6 31 34 450 05 2	4014586615493	HSS-NOVA 50 Annular Cutter Ø 45 x 50 Weldon	98.61	20	104
6 31 34 450 05 3	4014586615530	HSS-NOVA 75 Annular Cutter Ø 45 x 75 Weldon	160.64	20	104
6 31 34 450 07 5	4014586615462	HSS-DURA 25 Annular Cutter Ø 45 x 25 Weldon TIN	107.79	20	105
6 31 34 450 07 6	4014586615509	HSS-DURA 50 Annular Cutter Ø 45 x 50 Weldon TIN	129.47	20	105
6 31 34 460 05 1	4014586615547	HSS-NOVA 25 Annular Cutter Ø 46 x 25 Weldon	88.91	20	104
6 31 34 460 05 2	4014586615608	HSS-NOVA 50 Annular Cutter Ø 46 x 50 Weldon	108.48	20	104
6 31 34 460 07 5	4014586615554	HSS-DURA 25 Annular Cutter Ø 46 x 25 Weldon TIN	120.08	20	105
6 31 34 460 07 6	4014586615615	HSS-DURA 50 Annular Cutter Ø 46 x 50 Weldon TIN	144.98	20	105
6 31 34 470 05 1	4014586615660	HSS-NOVA 25 Annular Cutter Ø 47 x 25 Weldon	88.91	20	104
6 31 34 470 05 2	4014586615707	HSS-NOVA 50 Annular Cutter Ø 47 x 50 Weldon	108.48	20	104
6 31 34 470 07 5	4014586615677	HSS-DURA 25 Annular Cutter Ø 47 x 25 Weldon TIN	120.08	20	105
6 31 34 470 07 6	4014586615714	HSS-DURA 50 Annular Cutter Ø 47 x 50 Weldon TIN	144.98	20	105
6 31 34 480 05 1	4014586615745	HSS-NOVA 25 Annular Cutter Ø 48 x 25 Weldon	92.60	20	104
6 31 34 480 05 2	4014586615783	HSS-NOVA 50 Annular Cutter Ø 48 x 50 Weldon	113.40	20	104
6 31 34 480 07 5	4014586615752	HSS-DURA 25 Annular Cutter Ø 48 x 25 Weldon TIN	131.01	20	105
6 31 34 480 07 6	4014586615790	HSS-DURA 50 Annular Cutter Ø 48 x 50 Weldon TIN	155.32	20	105
6 31 34 490 05 1	4014586615820	HSS-NOVA 25 Annular Cutter Ø 49 x 25 Weldon	92.60	20	104
6 31 34 490 05 2	4014586615868	HSS-NOVA 50 Annular Cutter Ø 49 x 50 Weldon	113.40	20	104
6 31 34 490 07 5	4014586615837	HSS-DURA 25 Annular Cutter Ø 49 x 25 Weldon TIN	131.01	20	105
6 31 34 490 07 6	4014586615875	HSS-DURA 50 Annular Cutter Ø 49 x 50 Weldon TIN	155.32	20	105
6 31 34 500 05 1	4014586615967	HSS-NOVA 25 Annular Cutter Ø 50 x 25 Weldon	95.12	20	104
6 31 34 500 05 2	4014586615998	HSS-NOVA 50 Annular Cutter Ø 50 x 50 Weldon	117.12	20	104
6 31 34 500 05 3	4014586616025	HSS-NOVA 75 Annular Cutter Ø 50 x 75 Weldon	180.72	20	104
6 31 34 500 07 5	4014586615974	HSS-DURA 25 Annular Cutter Ø 50 x 25 Weldon TIN	134.54	20	105
6 31 34 500 07 6	4014586616001	HSS-DURA 50 Annular Cutter Ø 50 x 50 Weldon TIN	155.32	20	105
6 31 34 510 05 1	4014586616032	HSS-NOVA 25 Annular Cutter Ø 51 x 25 Weldon	98.77	20	104
6 31 34 510 05 2	4014586616056	HSS-NOVA 50 Annular Cutter Ø 51 x 50 Weldon	136.47	20	104
6 31 34 510 07 5	4014586616049	HSS-DURA 25 Annular Cutter Ø 51 x 25 Weldon TIN	139.19	20	105
6 31 34 510 07 6	4014586616063	HSS-DURA 50 Annular Cutter Ø 51 x 50 Weldon TIN	174.66	20	105
6 31 34 520 05 1	4014586616070	HSS-NOVA 25 Annular Cutter Ø 52 x 25 Weldon	98.77	20	104
6 31 34 520 05 2	4014586616094	HSS-NOVA 50 Annular Cutter Ø 52 x 50 Weldon	136.47	20	104
6 31 34 520 07 5	4014586616087	HSS-DURA 25 Annular Cutter Ø 52 x 25 Weldon TIN	139.19	20	105
6 31 34 520 07 6	4014586616100	HSS-DURA 50 Annular Cutter Ø 52 x 50 Weldon TIN	174.66	20	105
6 31 34 530 05 1	4014586616117	HSS-NOVA 25 Annular Cutter Ø 53 x 25 Weldon	104.96	20	104
6 31 34 530 05 2	4014586616131	HSS-NOVA 50 Annular Cutter Ø 53 x 50 Weldon	136.47	20	104
6 31 34 530 07 5	4014586616124	HSS-DURA 25 Annular Cutter Ø 53 x 25 Weldon TIN	146.02	20	105
6 31 34 530 07 6	4014586616148	HSS-DURA 50 Annular Cutter Ø 53 x 50 Weldon TIN	184.21	20	105
6 31 34 540 05 1	4014586616155	HSS-NOVA 25 Annular Cutter Ø 54 x 25 Weldon	104.96	20	104
6 31 34 540 05 2	4014586616179	HSS-NOVA 50 Annular Cutter Ø 54 x 50 Weldon	142.97	20	104
6 31 34 540 07 5	4014586616162	HSS-DURA 25 Annular Cutter Ø 54 x 25 Weldon TIN	146.02	20	105
6 31 34 540 07 6	4014586616186	HSS-DURA 50 Annular Cutter Ø 54 x 50 Weldon TIN	184.21	20	105
6 31 34 550 05 1	4014586616193	HSS-NOVA 25 Annular Cutter Ø 55 x 25 Weldon	114.83	20	104
6 31 34 550 05 2	4014586616216	HSS-NOVA 50 Annular Cutter Ø 55 x 50 Weldon	142.97	20	104
6 31 34 550 05 3	4014586616230	HSS-NOVA 75 Annular Cutter Ø 55 x 75 Weldon	194.12	20	-
6 31 34 550 07 5	4014586616209	HSS-DURA 25 Annular Cutter Ø 55 x 25 Weldon TIN	150.12	20	105
6 31 34 550 07 6	4014586616223	HSS-DURA 50 Annular Cutter Ø 55 x 50 Weldon TIN	188.31	20	105

Accessories in numerical order

Part number	EAN	Description	£ List Price excl, VAT	PC	Page
6 31 34 560 05 1	4014586616247	HSS-NOVA 25 Annular Cutter Ø 56 x 25 Weldon	130.88	20	104
6 31 34 560 05 2	4014586616261	HSS-NOVA 50 Annular Cutter Ø 56 x 50 Weldon	149.45	20	104
6 31 34 560 07 5	4014586616254	HSS-DURA 25 Annular Cutter Ø 56 x 25 Weldon TIN	156.94	20	105
6 31 34 560 07 6	4014586616278	HSS-DURA 50 Annular Cutter Ø 56 x 50 Weldon TIN	196.50	20	105
6 31 34 570 05 1	4014586616285	HSS-NOVA 25 Annular Cutter Ø 57 x 25 Weldon	130.88	20	104
6 31 34 570 05 2	4014586616308	HSS-NOVA 50 Annular Cutter Ø 57 x 50 Weldon	149.45	20	104
6 31 34 570 07 5	4014586616292	HSS-DURA 25 Annular Cutter Ø 57 x 25 Weldon TIN	156.94	20	105
6 31 34 570 07 6	4014586616315	HSS-DURA 50 Annular Cutter Ø 57 x 50 Weldon TIN	196.50	20	105
6 31 34 580 05 1	4014586616322	HSS-NOVA 25 Annular Cutter Ø 58 x 25 Weldon	140.75	20	104
6 31 34 580 05 2	4014586616346	HSS-NOVA 50 Annular Cutter Ø 58 x 50 Weldon	159.86	20	104
6 31 34 580 07 5	4014586616339	HSS-DURA 25 Annular Cutter Ø 58 x 25 Weldon TIN	170.59	20	105
6 31 34 580 07 6	4014586616353	HSS-DURA 50 Annular Cutter Ø 58 x 50 Weldon TIN	212.89	20	105
6 31 34 590 05 1	4014586616360	HSS-NOVA 25 Annular Cutter Ø 59 x 25 Weldon	140.75	20	104
6 31 34 590 05 2	4014586616384	HSS-NOVA 50 Annular Cutter Ø 59 x 50 Weldon	159.86	20	104
6 31 34 590 07 5	4014586616377	HSS-DURA 25 Annular Cutter Ø 59 x 25 Weldon TIN	170.59	20	105
6 31 34 590 07 6	4014586616391	HSS-DURA 50 Annular Cutter Ø 59 x 50 Weldon TIN	212.89	20	105
6 31 34 600 05 1	4014586616407	HSS-NOVA 25 Annular Cutter Ø 60 x 25 Weldon	144.54	20	104
6 31 34 600 05 2	4014586616421	HSS-NOVA 50 Annular Cutter Ø 60 x 50 Weldon	159.86	20	104
6 31 34 600 05 3	4014586616445	HSS-NOVA 75 Annular Cutter Ø 60 x 75 Weldon	226.81	20	104
6 31 34 600 07 5	4014586616414	HSS-DURA 25 Annular Cutter Ø 60 x 25 Weldon TIN	170.59	20	105
6 31 34 600 07 6	4014586616438	HSS-DURA 50 Annular Cutter Ø 60 x 50 Weldon TIN	212.89	20	105
6 31 34 998 30 0	4014586629926	Centering pin	15.13	02	106
6 31 34 998 31 0	4014586629940	Centering pin	15.13	02	-
6 31 34 999 06 1	4014586375588	Best of core bits HSS NOVA 25 W 12,14,16,18,20,22 mm accessory set	151.91	20	103
6 31 34 999 06 2	4014586375595	Best of core bits HSS NOVA 25 W 2x 14 mm, 2x 18 mm accessory set	95.71	20	103
6 31 34 999 06 3	4014586375601	Best of core bits HSS NOVA 50 W 12,14,16,18,20,22 mm accessory set	190.16	20	103
6 31 34 999 06 4	4014586375618	Best of core bits HSS NOVA 50 W 2x 14 mm, 2x 18 mm accessory set	126.40	20	103
6 32 02 003 01 4	4014586176925	Key-type drill chucks	37.44	02	-
6 32 02 022 01 8	4014586176956	Key-type drill chucks	110.90	02	9
6 32 02 028 01 9	4014586176963	Key-type drill chucks	38.00	02	-
6 32 02 030 01 5	4014586176987	Key-type drill chucks	48.44	02	9
6 32 02 037 01 0	4014586177007	Key-type drill chucks	68.31	02	9
6 32 02 043 01 0	4014586177038	Key-type drill chucks	40.62	02	11
6 32 02 044 01 8	4014586223674	Key-type drill chucks	36.61	02	11
6 32 03 034 01 0	4014586177052	Key-type drill chucks	34.97	02	9
6 32 03 041 01 4	4014586177083	Key-type drill chucks	43.93	02	9
6 32 03 050 01 4	4014586204291	Key-type drill chucks	52.60	02	-
6 32 04 016 00 7	4014586177212	Quick-action chucks	70.68	02	9
6 32 04 017 00 1	4014586177229	Quick-action chucks	85.41	02	9
6 32 04 020 00 5	4014586177250	Quick-action chucks	87.03	02	-
6 32 04 025 00 3	4014586177281	Quick-action chucks	100.64	02	9
6 32 04 028 00 8	4014586177311	Quick-action chucks	73.95	02	-
6 32 04 030 00 4	4014586177335	Quick-action chucks	74.02	02	-
6 32 04 032 00 6	4014586177359	Quick-action chucks	91.69	02	9
6 32 05 031 01 3	4014586256788	Quick-action chucks	29.46	02	-
6 32 05 032 01 6	4014586256795	Quick-action chucks	38.87	02	-
6 32 05 033 01 0	4014586266084	Quick-action chucks	91.24	02	9
6 32 05 035 01 0	4014586321721	Quick-action chucks	73.10	02	8
6 32 05 036 01 0	4014586321738	Quick-action chucks	76.33	02	8
6 32 05 037 02 0	4014586365091	Drill chuck	29.14	02	-
6 32 05 038 01 0	4014586368870	Quick-action chucks	107.43	02	9
6 32 06 018 00 5	4014586177410	Jaw chuck	105.00	02	-
6 32 06 018 01 0	4014586336459	Jaw chuck	115.05	02	99
6 32 06 019 00 9	4014586177427	Jaw chuck	95.56	02	17
6 32 06 040 00 9	4014586177441	Floating jaw chuck	153.59	02	-
6 32 06 041 00 8	4014586177458	Floating jaw chuck	141.01	02	17
6 32 06 061 02 1	4014586177465	Floating jaw chuck	151.59	02	-
6 32 06 063 01 2	4014586177489	Collet chuck	93.70	02	16
6 32 06 064 00 1	4014586177496	Collets, Ø3.5 mm	26.03	02	16
6 32 06 065 00 5	4014586177502	Collets, Ø4.5 mm	26.03	02	16
6 32 06 066 00 8	4014586177519	Collets, Ø6 mm	26.03	02	16
6 32 06 067 01 1	4014586177526	Collet chuck	101.24	02	-
6 32 06 067 02 0	4014586336749	Collet chuck	113.20	02	99
6 32 06 070 00 6	4014586177533	Collets	26.03	02	16
6 32 06 075 00 4	4014586177588	Collet, Ø9 mm	26.03	02	17
6 32 06 076 02 2	4014586177595	Floating collet chuck	146.97	02	16
6 32 06 077 00 1	4014586177601	Collet, Ø2.8 mm	26.03	02	16
6 32 06 078 00 9	4014586177618	Collet, Ø8 mm	26.03	02	17
6 32 06 079 00 3	4014586177625	Collet, Ø10 mm	25.29	02	17
6 32 06 095 01 1	4014586224350	Tapping insert M6	78.58	02	119
6 32 06 096 01 4	4014586224367	Tapping insert M10	78.58	02	119
6 32 06 097 01 8	4014586224374	Tapping insert M12	78.58	02	119
6 32 06 098 01 6	4014586224381	Tapping insert M14	78.58	02	119
6 32 06 099 01 0	4014586224398	Tapping insert M16	78.58	02	119
6 32 06 100 01 1	4014586224404	Tapping insert M18	78.58	02	119
6 32 06 101 01 0	4014586224411	Tapping insert M20	78.58	02	119
6 32 06 102 01 3	4014586229294	Tapping insert M8 w/clutch	239.98	02	119



Part number	EAN	Description	£ List Price excl. VAT	PC	Page
6 32 06 103 01 7	4014586229300	Tapping insert M10 w/clutch	239.98	02	119
6 32 06 104 01 5	4014586229317	Tapping insert M12 w/clutch	244.59	02	119
6 32 06 105 01 9	4014586229324	Tapping insert M14 w/clutch	239.98	02	119
6 32 06 106 01 2	4014586229331	Tapping insert M16 w/clutch	239.98	02	119
6 32 06 107 01 6	4014586229348	Tapping insert M18 w/clutch	239.98	02	119
6 32 06 108 01 4	4014586229355	Tapping insert M20 w/clutch	244.59	02	119
6 32 06 117 01 5	4014586253459	Tapping insert M6	77.10	02	119
6 32 06 118 01 3	4014586253466	Tapping insert M6 w/clutch	239.98	02	119
6 32 06 119 01 0	4014586298689	Tapping insert M22/ M24	178.32	02	123
6 32 06 120 01 0	4014586298696	Tapping insert M27	178.32	02	123
6 32 06 122 01 0	4014586298719	Tapping insert M22/ M24 with coupling	379.00	02	123
6 32 06 123 01 0	4014586298726	Tapping insert M27 with coupling	371.86	02	123
6 32 06 125 01 0	4014586298740	Interchangeable reducing insert	224.06	02	123
6 32 06 138 01 0	4014586354446	Tapping insert M8	72.57	02	119
6 32 06 139 01 0	4014586354453	Tapping insert M10	72.57	02	119
6 32 06 140 01 0	4014586354460	Tapping insert M8 w/clutch	239.98	02	119
6 32 06 141 01 0	4014586354477	Tapping insert M10 w/clutch	239.98	02	119
6 32 06 146 01 0	4014586633435	Adapter with 3/4" Weldon fitting	22.05	02	106
6 32 06 147 01 0	4014586633442	Adapter with 3/4" Weldon fitting	22.05	02	106
6 32 06 148 01 0	4014586633459	Adapter with 3/4" Weldon fitting	22.05	02	106
6 32 06 149 01 0	4014586634562	Adapter with 3/4" Weldon fitting	22.05	02	106
6 32 07 059 00 6	4014586177786	Collet, Ø6 mm	26.03	02	61
6 32 07 069 00 5	4014586177793	Collet, Ø8 mm	26.03	02	61
6 32 07 087 00 1	4014586177809	Collet, Ø3 mm	26.03	02	61
6 32 07 088 00 9	4014586177816	Collet, Ø1/4" Z	26.03	02	61
6 32 07 097 00 0	4014586177861	Collets, Ø3 mm	25.56	02	61
6 32 07 103 00 9	4014586177922	Collets, Ø6 mm	26.03	02	61
6 32 07 128 00 0	4014586375922	Collet, Ø6 mm	21.96	02	61
6 32 07 129 00 0	4014586375939	Collet, Ø8 mm	21.96	02	61
6 32 07 130 00 0	4014586375946	Collet, Ø3 mm	23.34	02	61
6 32 07 131 00 0	4014586375953	Collet, Ø1/4"	21.96	02	61
6 32 07 132 00 0	4014586375960	Collet, Ø3 Inox	27.01	02	61
6 32 07 133 00 0	4014586375977	Collet, Ø6 Inox	25.42	02	61
6 32 07 134 00 0	4014586375984	Collet, Ø8 Inox	27.01	02	61
6 32 07 135 00 0	4014586375991	Collet, Ø1/4" Inox	27.01	02	61
6 32 08 001 02 0	4014586368153	Drill chuck	49.79	02	-
6 32 08 002 01 0	4014586392080	Drill chuck	39.71	02	25
6 32 08 005 01 0	4014586404837	Drill chuck	46.84	02	25
6 33 01 006 00 5	4014586178103	Morse taper arbors	9.26	02	-
6 33 01 008 00 7	4014586178110	Morse taper arbors	11.43	02	-
6 33 01 012 00 5	4014586178141	Morse taper arbors	13.93	02	9
6 33 01 014 00 7	4014586178165	Morse taper arbors	18.90	02	9
6 33 01 016 00 4	4014586178172	Morse taper arbors	36.18	02	9
6 33 01 021 00 1	4014586223704	Morse taper arbors	46.39	02	-
6 33 02 002 00 0	4014586178189	Reducing sleeves	12.44	02	-
6 33 02 003 00 4	4014586178196	Reducing sleeves	16.57	02	9
6 33 02 004 00 2	4014586178202	Reducing sleeves	22.59	02	9
6 33 04 003 00 2	4014586178226	Enlargement tapers	63.12	02	-
6 33 04 004 00 0	4014586178233	Enlargement tapers	109.01	02	9
6 33 04 005 00 0	4014586312996	Enlargement tapers	178.32	02	123
6 33 05 003 00 3	4014586178257	WEDGE	4.62	02	9
6 33 05 004 00 1	4014586178264	WEDGE	6.79	02	9
6 33 05 006 00 8	4014586178288	WEDGE	10.98	02	92
6 33 05 009 01 3	4014586230627	DRIFT	31.67	02	17
6 33 05 010 01 5	4014586230634	DRIFT	31.40	02	-
6 34 02 027 00 0	4014586199672	Ratchet w/ square head	52.82	02	-
6 35 02 022 00 6	4014586178417	Circular saw blade	407.00	08	-
6 35 02 097 21 0	4014586389431	HSS saw blade round SL Ø 85 (1)	19.71	04	159
6 35 02 097 22 0	4014586389448	HSS saw blade round SL Ø 85 (2)	39.53	04	159
6 35 02 097 23 0	4014586389455	HSS saw blade round SL Ø 85 (5)	88.74	04	159
6 35 02 102 01 6	4014586178783	HSS saw blade, circular, Ø63, 2-pack	46.31	04	171
6 35 02 102 07 0	4014586291703	HSS saw blade, circular, Ø63, 5-pack	92.56	04	171
6 35 02 103 01 0	4014586178806	HSS saw blade, circular, Ø80, 2-pack	48.22	04	171
6 35 02 103 03 0	4014586269504	Saw blade (circular), pack of 1	21.57	04	-
6 35 02 103 05 0	4014586291710	Saw blade, circular, 5-pack	96.33	04	171
6 35 02 106 21 0	4014586389462	HSS saw blade segmented SL Ø 85 (1)	22.62	04	159
6 35 02 106 22 0	4014586389479	HSS saw blade segmented SL Ø 85 (2)	42.98	04	159
6 35 02 106 23 0	4014586389486	HSS saw blade segmented SL Ø 85 (5)	101.78	04	159
6 35 02 113 21 0	4014586390222	Saw blade segmented SL Ø 85	19.26	04	159
6 35 02 114 21 0	4014586390239	Diamond-coated saw blade segmented SL Ø 75 x 2,2 (1)	52.57	04	166
6 35 02 114 23 0	4014586390246	Diamond-coated saw blade segmented SL Ø 75 x 2,2 (5)	236.54	04	166
6 35 02 115 01 1	4014586231914	Saw blade	110.65	04	173
6 35 02 115 03 0	4014586315058	Saw blade (5 each)	446.96	04	173
6 35 02 116 01 4	4014586231921	Saw blade	110.65	04	174
6 35 02 116 02 0	4014586315065	Saw blade (5 each)	446.96	04	174
6 35 02 118 21 0	4014586389493	Carbide saw blade segmented SL Ø 75 x 2,2 (1)	24.82	04	165
6 35 02 118 23 0	4014586389509	Carbide saw blade segmented SL Ø 75 x 2,2 (5)	111.72	04	165

Accessories in numerical order

Part number	EAN	Description	£ List Price excl, VAT	PC	Page
6 35 02 119 01 0	4014586232348	Precision E-Cut saw blade, 1-pack	20.59	04	172
6 35 02 119 03 2	4014586258829	Precision E-Cut saw blade, 25-pack	375.00	04	172
6 35 02 119 04 8	4014586264561	Precision E-Cut saw blade, 5-pack	85.72	04	172
6 35 02 120 01 2	4014586232355	Precision E-Cut saw blade, 1-pack	21.18	04	172
6 35 02 120 03 4	4014586258836	Precision E-Cut saw blade, 25-pack	385.02	04	172
6 35 02 120 04 0	4014586264578	Precision E-Cut saw blade, 5-pack	88.02	04	172
6 35 02 121 01 1	4014586232362	Precision E-Cut saw blade, 1-pack	21.72	04	172
6 35 02 121 03 3	4014586258843	Precision E-Cut saw blade, 25-pack	395.45	04	172
6 35 02 121 04 9	4014586264585	Precision E-Cut saw blade, 5-pack	90.39	04	172
6 35 02 122 01 4	4014586232379	Precision E-Cut saw blade, 1-pack	22.27	04	172
6 35 02 122 03 6	4014586258850	Precision E-Cut saw blade, 25-pack	405.23	04	172
6 35 02 122 04 2	4014586264592	Precision E-Cut saw blade, 5-pack	92.65	04	172
6 35 02 123 01 8	4014586232386	Standard E-Cut saw blade, 1-pack	14.68	04	171
6 35 02 123 03 0	4014586250793	Standard E-Cut saw blade, 25-pack	267.54	04	171
6 35 02 123 04 6	4014586264608	Standard E-Cut saw blade, 5-pack	61.16	04	171
6 35 02 124 01 6	4014586232393	Standard E-Cut saw blade, 1-pack	15.30	04	171
6 35 02 124 03 8	4014586250809	Standard E-Cut saw blade, 25-pack	277.97	04	171
6 35 02 124 04 4	4014586264615	Standard E-Cut saw blade, 5-pack	63.56	04	171
6 35 02 125 21 0	4014586389516	Carbide saw blade segmented SL Ø 75 x 1,2 (1)	24.82	04	165
6 35 02 125 23 0	4014586389523	Carbide saw blade segmented SL Ø 75 x 1,2 (5)	111.72	04	165
6 35 02 126 21 0	4014586386157	E-Cut precision saw blade SL 50 x 35 (1)	13.04	04	161
6 35 02 126 22 0	4014586386164	E-Cut precision saw blade SL 50 x 35 (3)	37.22	04	161
6 35 02 126 23 0	4014586386171	E-Cut precision saw blade SL 50 x 35 (5)	59.92	04	161
6 35 02 126 24 0	4014586386188	E-Cut precision saw blade SL 50 x 35 (10)	111.03	04	161
6 35 02 126 25 0	4014586390260	E-Cut precision saw blade SL 50 x 35 (50)	528.84	04	161
6 35 02 127 21 0	4014586386232	E-Cut precision saw blade SLP 50 x 65 (1)	14.52	04	161
6 35 02 127 22 0	4014586386249	E-Cut precision saw blade SLP 50 x 65 (3)	41.38	04	161
6 35 02 127 23 0	4014586386256	E-Cut precision saw blade SLP 50 x 65 (5)	65.36	04	161
6 35 02 127 24 0	4014586386263	E-Cut precision saw blade SLP 50 x 65 (10)	123.38	04	161
6 35 02 127 25 0	4014586390291	E-Cut precision saw blade SLP 50 x 65 (50)	587.97	04	161
6 35 02 129 01 9	4014586248400	MINICUT HSS saw blade (20mm), 2-pack	14.33	04	-
6 35 02 130 01 1	4014586248417	MINICUT HSS saw blade (10mm), 2-pack	14.33	04	-
6 35 02 133 21 0	4014586386317	E-Cut standard saw blade SL 50 x 35 (1)	9.96	04	160
6 35 02 133 22 0	4014586386324	E-Cut standard saw blade SL 50 x 35 (3)	28.38	04	160
6 35 02 133 23 0	4014586386331	E-Cut standard saw blade SL 50 x 35 (5)	44.81	04	160
6 35 02 133 24 0	4014586386348	E-Cut standard saw blade SL 50 x 35 (10)	84.60	04	160
6 35 02 133 25 0	4014586390321	E-Cut standard saw blade SL 50 x 35 (50)	403.22	04	160
6 35 02 134 21 0	4014586386393	E-Cut standard saw blade SLP 50 x 65 (1)	11.83	04	160
6 35 02 134 22 0	4014586386409	E-Cut standard saw blade SLP 50 x 65 (3)	33.70	04	160
6 35 02 134 23 0	4014586386416	E-Cut standard saw blade SLP 50 x 65 (5)	53.18	04	160
6 35 02 134 24 0	4014586386423	E-Cut standard saw blade SLP 50 x 65 (10)	100.48	04	160
6 35 02 134 25 0	4014586390352	E-Cut standard saw blade SLP 50 x 65 (50)	478.74	04	160
6 35 02 135 01 9	4014586248486	Standard E-Cut saw blade, 1-pack	16.00	04	172
6 35 02 135 02 5	4014586258867	Standard E-Cut saw blade, 25-pack	291.24	04	172
6 35 02 135 03 1	4014586264622	Standard E-Cut saw blade, 5-pack	66.57	04	172
6 35 02 136 01 2	4014586248493	Standard E-Cut saw blade, 1-pack	17.34	04	172
6 35 02 136 02 8	4014586258874	Standard E-Cut saw blade, 25-pack	315.39	04	172
6 35 02 136 03 4	4014586264639	Standard E-Cut saw blade, 5-pack	72.08	04	172
6 35 02 138 01 4	4014586252247	M-Cut saw blade 2 pcs.	16.94	04	173
6 35 02 146 01 1	4014586259437	Diamond wheel, Ø 180 mm	119.77	02	93
6 35 02 147 01 5	4014586262321	Universal E-Cut saw blades	20.39	04	172
6 35 02 147 02 1	4014586264646	Universal E-Cut saw blades, 5-pack	84.82	04	172
6 35 02 147 03 7	4014586264721	Universal E-Cut saw blades, 25-pack	371.08	04	172
6 35 02 147 12 0	4014586369655	Best of E-Cut accessory set	74.45	04	171
6 35 02 148 01 3	4014586262338	Universal E-Cut saw blades	20.97	04	172
6 35 02 148 02 9	4014586264653	Universal E-Cut saw blades, 5-pack	87.14	04	172
6 35 02 148 03 5	4014586264738	Universal E-Cut saw blades, 25-pack	381.33	04	172
6 35 02 151 21 0	4014586386461	E-Cut universal saw blade SLP 60 x 28 (1)	14.52	04	162
6 35 02 151 22 0	4014586386478	E-Cut universal saw blade SLP 60 x 28 (3)	41.37	04	162
6 35 02 151 23 0	4014586386485	E-Cut universal saw blade SLP 60 x 28 (5)	65.32	04	162
6 35 02 151 24 0	4014586386492	E-Cut universal saw blade SLP 60 x 28 (10)	123.40	04	162
6 35 02 151 25 0	4014586390390	E-Cut universal saw blade SLP 60 x 28 (50)	587.99	04	162
6 35 02 152 21 0	4014586386539	E-Cut universal saw blade SLP 60 x 44 (1)	15.15	04	162
6 35 02 152 22 0	4014586386546	E-Cut universal saw blade SLP 60 x 44 (3)	43.14	04	162
6 35 02 152 23 0	4014586386553	E-Cut universal saw blade SLP 60 x 44 (5)	68.11	04	162
6 35 02 152 24 0	4014586386560	E-Cut universal saw blade SLP 60 x 44 (10)	128.67	04	162
6 35 02 152 25 0	4014586390437	E-Cut universal saw blade SLP 60 x 44 (50)	613.01	04	162
6 35 02 155 01 0	4014586291956	HM saw blade 1-pack	43.52	04	-
6 35 02 155 02 0	4014586294186	HM saw blade 5-pack	174.00	04	-
6 35 02 156 01 0	4014586291963	HM saw blade 1-pack	43.52	04	-
6 35 02 156 02 0	4014586294209	HM saw blade 5-pack	174.00	04	-
6 35 02 157 21 0	4014586386614	E-Cut fine saw blade SL 50 x 30 (1)	9.76	04	162
6 35 02 157 22 0	4014586386621	E-Cut fine saw blade SL 50 x 30 (3)	27.79	04	162
6 35 02 157 23 0	4014586386638	E-Cut fine saw blade SL 50 x 30 (5)	43.89	04	162
6 35 02 157 24 0	4014586386645	E-Cut fine saw blade SL 50 x 30 (10)	82.84	04	162
6 35 02 157 25 0	4014586390451	E-Cut fine saw blade SL 50 x 30 (50)	395.03	04	162
6 35 02 158 01 0	4014586304892	M-Cut saw blade 2 pcs.	18.04	04	173





Part number	EAN	Description	£ List Price excl. VAT	PC	Page
6 35 02 160 21 0	4014586386690	E-Cut long-life saw blade SL 50 x 35 (1)	12.85	04	160
6 35 02 160 22 0	4014586386706	E-Cut long-life saw blade SL 50 x 35 (3)	36.63	04	160
6 35 02 160 23 0	4014586386713	E-Cut long-life saw blade SL 50 x 35 (5)	57.85	04	160
6 35 02 160 24 0	4014586386720	E-Cut long-life saw blade SL 50 x 35 (10)	109.30	04	160
6 35 02 160 25 0	4014586390482	E-Cut long-life saw blade SL 50 x 35 (50)	520.62	04	160
6 35 02 161 21 0	4014586386775	E-Cut long-life saw blade SLP 50 x 65 (1)	13.90	04	160
6 35 02 161 22 0	4014586386782	E-Cut long-life saw blade SLP 50 x 65 (3)	39.60	04	160
6 35 02 161 23 0	4014586386799	E-Cut long-life saw blade SLP 50 x 65 (5)	62.51	04	160
6 35 02 161 24 0	4014586386805	E-Cut long-life saw blade SLP 50 x 65 (10)	118.11	04	160
6 35 02 161 25 0	4014586390512	E-Cut long-life saw blade SLP 50 x 65 (50)	562.53	04	160
6 35 02 162 01 0	4014586336008	E-Cut long-life saw blade pack of 1	16.17	04	171
6 35 02 162 02 0	4014586336015	E-Cut long-life saw blade pack of 5	67.29	04	171
6 35 02 162 03 0	4014586336022	E-Cut long-life saw blade pack of 25	294.29	04	171
6 35 02 162 15 0	4014586376295	Best of E-Cut accessory set XXL	105.52	04	171
6 35 02 163 01 0	4014586336039	E-Cut long-life saw blade pack of 1	16.80	04	171
6 35 02 163 02 0	4014586336046	E-Cut long-life saw blade pack of 5	69.88	04	171
6 35 02 163 03 0	4014586336053	E-Cut long-life saw blade pack of 25	305.61	04	171
6 35 02 164 01 0	4014586336060	E-Cut long-life saw blade pack of 1	17.23	04	171
6 35 02 164 02 0	4014586336077	E-Cut long-life saw blade pack of 5	71.56	04	171
6 35 02 164 03 0	4014586336084	E-Cut long-life saw blade pack of 25	313.23	04	171
6 35 02 165 01 0	4014586336091	E-Cut long-life saw blade pack of 1	18.68	04	171
6 35 02 165 02 0	4014586336107	E-Cut long-life saw blade pack of 5	77.63	04	171
6 35 02 165 03 0	4014586336114	E-Cut long-life saw blade pack of 25	339.75	04	171
6 35 02 166 21 0	4014586390536	Diamond-coated saw blade segmented SLP Ø 90 x 2,2 (1)	62.15	04	166
6 35 02 166 23 0	4014586390543	Diamond-coated saw blade segmented SLP Ø 90 x 2,2 (5)	279.67	04	166
6 35 02 167 01 0	4014586342023	Diamond-coated saw blade	111.75	04	173
6 35 02 167 02 0	4014586342030	Diamond-coated saw blade, 5-pack	446.97	04	173
6 35 02 168 01 0	4014586342047	Diamond-coated saw blade	111.75	04	174
6 35 02 168 02 0	4014586342054	Diamond-coated saw blade, 5-pack	446.97	04	174
6 35 02 169 21 0	4014586390550	Carbide saw blade segmented SLP Ø 90 x 2,2 (1)	29.49	04	165
6 35 02 169 23 0	4014586390567	Carbide saw blade segmented SLP Ø 90 x 2,2 (5)	132.69	04	165
6 35 02 170 21 0	4014586390574	Carbide saw blade segmented SLP Ø 90 x 1,2 (1)	30.36	04	165
6 35 02 170 23 0	4014586390581	Carbide saw blade segmented SLP Ø 90 x 1,2 (5)	136.61	04	165
6 35 02 172 01 0	4014586347691	HM saw blade 1-pack	43.52	04	173
6 35 02 172 02 0	4014586347707	HM saw blade 5-pack	174.00	04	173
6 35 02 173 01 0	4014586347714	HM saw blade 1-pack	43.52	04	173
6 35 02 173 02 0	4014586347721	HM saw blade 5-pack	174.00	04	173
6 35 02 174 21 0	4014586389530	HSS saw blade round SL Ø 85 x 0,7 (1)	40.30	04	159
6 35 02 174 23 0	4014586389547	HSS saw blade round SL Ø 85 x 0,7 (5)	181.35	04	159
6 35 02 175 21 0	4014586389554	HSS saw blade round SLP Ø 100 x 0,7 (1)	41.96	04	159
6 35 02 175 23 0	4014586389561	HSS saw blade round SLP Ø 100 x 0,7 (5)	188.81	04	159
6 35 02 176 21 0	4014586389578	HSS saw blade round SLP Ø 100 x 0,8 (1)	49.98	04	159
6 35 02 177 01 0	4014586379494	Saw blade	47.41	04	171
6 35 02 177 05 0	4014586379500	HSS saw blade pack of 5	189.70	04	171
6 35 02 178 01 0	4014586379517	Saw blade	49.38	04	171
6 35 02 178 05 0	4014586379524	HSS saw blade pack of 5	197.46	04	171
6 35 02 179 01 0	4014586379272	HSS single saw blade, wood	70.28	04	172
6 35 02 179 02 0	4014586379289	Set with depth stop	72.43	04	172
6 35 02 183 21 0	4014586386850	E-Cut long-life saw blade SL 34 x 20 (1)	9.76	04	159
6 35 02 183 22 0	4014586386867	E-Cut long-life saw blade SL 34 x 20 (3)	27.79	04	159
6 35 02 183 23 0	4014586386874	E-Cut long-life saw blade SL 34 x 20 (5)	43.89	04	159
6 35 02 183 24 0	4014586386881	E-Cut long-life saw blade SL 34 x 20 (10)	82.84	04	159
6 35 02 183 25 0	4014586390604	E-Cut long-life saw blade SL 34 x 20 (50)	395.03	04	159
6 35 02 184 21 0	4014586386935	E-Cut long-life saw blade SL 30 x 10 (1)	7.46	04	159
6 35 02 184 22 0	4014586386942	E-Cut long-life saw blade SL 30 x 10 (3)	21.30	04	159
6 35 02 184 23 0	4014586386959	E-Cut long-life saw blade SL 30 x 10 (5)	33.60	04	159
6 35 02 184 24 0	4014586386966	E-Cut long-life saw blade SL 30 x 10 (10)	63.45	04	159
6 35 02 184 25 0	4014586390635	E-Cut long-life saw blade SL 30 x 10 (50)	302.61	04	159
6 35 02 185 01 0	4014586369723	E-Cut long-life saw blade pack of 1	13.13	04	171
6 35 02 185 02 0	4014586369730	E-Cut long-life saw blade pack of 5	54.68	04	171
6 35 02 185 03 0	4014586369747	E-Cut long-life saw blade pack of 25	239.25	04	171
6 35 02 186 01 0	4014586369754	E-Cut long-life saw blade pack of 1	10.15	04	171
6 35 02 186 02 0	4014586369761	E-Cut long-life saw blade pack of 5	42.24	04	171
6 35 02 186 03 0	4014586369778	E-Cut long-life saw blade pack of 25	184.69	04	171
6 35 02 187 21 0	4014586390659	Carbide saw blade segmented SLP Ø 90	38.97	04	162
6 35 02 188 21 0	4014586390666	Diamond-coated saw blade segmented SLP Ø 90	79.08	04	162
6 35 02 189 01 0	4014586377537	Carbide saw blade with open teeth	48.46	04	173
6 35 02 190 01 0	4014586377544	Diamond segment saw blade with open teeth	116.84	04	173
6 35 02 191 21 0	4014586389585	E-Cut carbide saw blade SLP 50 x 35	27.50	04	162
6 35 02 192 01 0	4014586378152	E-Cut carbide saw blade	29.02	04	173
6 35 02 193 21 0	4014586389592	E-Cut diamond saw blade SLP 50 x 35	44.71	04	162
6 35 02 194 01 0	4014586378176	E-Cut diamond saw blade	47.15	04	173
6 35 02 195 01 0	4014586378183	E-Cut diamond saw blade	53.46	04	173
6 35 02 196 01 0	4014586379531	Saw blade	45.92	04	171
6 35 02 196 05 0	4014586379548	Saw blade (5 each)	206.63	04	171
6 35 02 196 21 0	4014586389608	HSS saw blade segmented SLP Ø 100 x 0,7 (1)	41.96	04	159
6 35 02 196 23 0	4014586389615	HSS saw blade segmented SLP Ø 100 x 0,7 (5)	188.81	04	159

Accessories in numerical order

Part number	EAN	Description	£ List Price excl, VAT	PC	Page
6 35 02 198 21 0	4014586387017	E-Cut precision saw blade SLP 50 x 45 (1)	13.53	04	-
6 35 02 198 22 0	4014586387024	E-Cut precision saw blade SLP 50 x 45 (3)	38.58	04	-
6 35 02 198 23 0	4014586387031	E-Cut precision saw blade SLP 50 x 45 (5)	60.92	04	-
6 35 02 198 24 0	4014586387048	E-Cut precision saw blade SLP 50 x 45 (10)	115.08	04	-
6 35 02 198 25 0	4014586390673	E-Cut precision saw blade SLP 50 x 45 (50)	548.27	04	-
6 35 02 199 21 0	4014586387093	E-Cut precision saw blade SLP 50 x 55 (1)	14.02	04	-
6 35 02 199 22 0	4014586387109	E-Cut precision saw blade SLP 50 x 55 (3)	39.95	04	-
6 35 02 199 23 0	4014586387116	E-Cut precision saw blade SLP 50 x 55 (5)	63.08	04	-
6 35 02 199 24 0	4014586387123	E-Cut precision saw blade SLP 50 x 55 (10)	119.16	04	-
6 35 02 199 25 0	4014586390697	E-Cut precision saw blade SLP 50 x 55 (50)	567.69	04	-
6 35 02 200 21 0	4014586387178	E-Cut standard saw blade SLM 78 x 32 (1)	12.76	04	160
6 35 02 200 22 0	4014586387185	E-Cut standard saw blade SLM 78 x 32 (3)	35.72	04	160
6 35 02 200 23 0	4014586387192	E-Cut standard saw blade SLM 78 x 32 (5)	57.49	04	160
6 35 02 200 24 0	4014586387208	E-Cut standard saw blade SLM 78 x 32 (10)	108.58	04	160
6 35 02 200 25 0	4014586390710	E-Cut standard saw blade SLM 78 x 32 (50)	517.19	04	160
6 35 02 201 21 0	4014586387253	E-Cut long-life saw blade SLM 78 x 32 (1)	14.53	04	160
6 35 02 201 22 0	4014586387260	E-Cut long-life saw blade SLM 78 x 32 (3)	40.56	04	160
6 35 02 201 23 0	4014586387277	E-Cut long-life saw blade SLM 78 x 32 (5)	65.39	04	160
6 35 02 201 24 0	4014586387284	E-Cut long-life saw blade SLM 78 x 32 (10)	123.52	04	160
6 35 02 201 25 0	4014586390734	E-Cut long-life saw blade SLM 78 x 32 (50)	588.42	04	160
6 35 02 202 21 0	4014586387338	E-Cut standard saw blade SLM 78 x 42 (1)	13.30	04	160
6 35 02 202 22 0	4014586387345	E-Cut standard saw blade SLM 78 x 42 (3)	37.10	04	160
6 35 02 202 23 0	4014586387352	E-Cut standard saw blade SLM 78 x 42 (5)	59.83	04	160
6 35 02 202 24 0	4014586387369	E-Cut standard saw blade SLM 78 x 42 (10)	112.95	04	160
6 35 02 202 25 0	4014586390802	E-Cut standard saw blade SLM 78 x 42 (50)	536.48	04	160
6 35 02 203 21 0	4014586387413	E-Cut long-life saw blade SLM 78 x 42 (1)	15.09	04	160
6 35 02 203 22 0	4014586387420	E-Cut long-life saw blade SLM 78 x 42 (3)	42.11	04	160
6 35 02 203 23 0	4014586387437	E-Cut long-life saw blade SLM 78 x 42 (5)	67.93	04	160
6 35 02 203 24 0	4014586387444	E-Cut long-life saw blade SLM 78 x 42 (10)	128.28	04	160
6 35 02 203 25 0	4014586390826	E-Cut long-life saw blade SLM 78 x 42 (50)	611.31	04	160
6 35 02 204 21 0	4014586389622	E-Cut diamond saw blade SLM 60 x 44	48.31	04	162
6 35 02 205 21 0	4014586387499	E-Cut precision BIM saw blade SL 50 x 35 (1)	14.37	04	161
6 35 02 205 22 0	4014586387505	E-Cut precision BIM saw blade SL 50 x 35 (3)	40.97	04	161
6 35 02 205 23 0	4014586387512	E-Cut precision BIM saw blade SL 50 x 35 (5)	65.90	04	161
6 35 02 205 24 0	4014586387529	E-Cut precision BIM saw blade SL 50 x 35 (10)	122.15	04	161
6 35 02 205 25 0	4014586390840	E-Cut precision BIM saw blade SL 50 x 35 (50)	581.94	04	161
6 35 02 206 21 0	4014586387574	E-Cut precision BIM saw blade SLP 50 x 45 (1)	14.90	04	-
6 35 02 206 22 0	4014586387581	E-Cut precision BIM saw blade SLP 50 x 45 (3)	42.43	04	-
6 35 02 206 23 0	4014586387598	E-Cut precision BIM saw blade SLP 50 x 45 (5)	67.00	04	-
6 35 02 206 24 0	4014586387604	E-Cut precision BIM saw blade SLP 50 x 45 (10)	126.58	04	-
6 35 02 206 25 0	4014586390864	E-Cut precision BIM saw blade SLP 50 x 45 (50)	603.09	04	-
6 35 02 207 21 0	4014586387659	E-Cut precision BIM saw blade SLP 50 x 55 (1)	15.42	04	-
6 35 02 207 22 0	4014586387666	E-Cut precision BIM saw blade SLP 50 x 55 (3)	43.96	04	-
6 35 02 207 23 0	4014586387673	E-Cut precision BIM saw blade SLP 50 x 55 (5)	69.39	04	-
6 35 02 207 24 0	4014586387680	E-Cut precision BIM saw blade SLP 50 x 55 (10)	131.06	04	-
6 35 02 207 25 0	4014586390888	E-Cut precision BIM saw blade SLP 50 x 55 (50)	624.69	04	-
6 35 02 208 21 0	4014586387734	E-Cut precision BIM saw blade SLP 50 x 65 (1)	15.98	04	161
6 35 02 208 22 0	4014586387741	E-Cut precision BIM saw blade SLP 50 x 65 (3)	45.50	04	161
6 35 02 208 23 0	4014586387758	E-Cut precision BIM saw blade SLP 50 x 65 (5)	71.88	04	161
6 35 02 208 24 0	4014586387765	E-Cut precision BIM saw blade SLP 50 x 65 (10)	135.74	04	161
6 35 02 208 25 0	4014586390901	E-Cut precision BIM saw blade SLP 50 x 65 (50)	646.69	04	161
6 35 02 209 01 0	4014586381602	E-Cut precision BIM saw blade (35mm) VE1	16.38	04	172
6 35 02 209 02 0	4014586381619	E-Cut precision BIM saw blade (35mm) VE5	73.69	04	172
6 35 02 209 03 0	4014586381626	E-Cut Precision BIM saw blade (35mm) VE25	327.48	04	172
6 35 02 210 01 0	4014586381633	E-Cut precision BIM saw blade (45mm) VE1	16.84	04	172
6 35 02 210 02 0	4014586381640	E-Cut precision BIM saw blade (45mm) VE5	75.66	04	172
6 35 02 210 03 0	4014586381657	E-Cut precision BIM saw blade (45mm) VE25	336.35	04	172
6 35 02 211 01 0	4014586381664	E-Cut precision BIM saw blade (55mm) VE1	17.25	04	172
6 35 02 211 02 0	4014586381671	E-Cut precision BIM saw blade (55mm) VE5	77.66	04	172
6 35 02 211 03 0	4014586381688	E-Cut Precision BIM saw blade (55mm) VE25	345.20	04	172
6 35 02 212 01 0	4014586381695	E-Cut precision BIM saw blade (65mm) VE1	17.72	04	172
6 35 02 212 02 0	4014586381701	E-Cut precision BIM saw blade (65mm) VE5	79.64	04	172
6 35 02 212 03 0	4014586381718	E-Cut Precision BIM saw blade (65mm) VE25	354.02	04	172
6 35 02 213 21 0	4014586390925	Carbide saw blade round SLM Ø 105 x 2,2 (1)	36.87	04	166
6 35 02 213 23 0	4014586390932	Carbide saw blade round SLM Ø 105 x 2,2 (5)	165.38	04	166
6 35 02 214 21 0	4014586390949	Carbide saw blade round SLM Ø 105 x 1,2 (1)	36.87	04	166
6 35 02 214 23 0	4014586390956	Carbide saw blade round SLM Ø 105 x 1,2 (5)	165.91	04	166
6 35 02 215 21 0	4014586390963	Carbide saw blade segmented SLM Ø 105 x 1,2	44.71	04	162
6 35 02 216 21 0	4014586390970	Diamond-coated saw blade segmented SL Ø 75 x 1,2 (1)	52.57	04	166
6 35 02 216 23 0	4014586390987	Diamond-coated saw blade segmented SL Ø 75 x 1,2 (5)	236.54	04	166
6 35 02 217 21 0	4014586390994	Diamond-coated saw blade segmented SLP Ø 90 x 1,2 (1)	62.15	04	166
6 35 02 217 23 0	4014586391007	Diamond-coated saw blade segmented SLP Ø 90 x 1,2 (5)	279.67	04	166
6 35 02 218 21 0	4014586391014	Diamond-coated saw blade round SLM Ø 105 x 2,2 (1)	94.70	04	166
6 35 02 218 23 0	4014586391021	Diamond-coated saw blade round SLM Ø 105 x 2,2 (5)	426.14	04	166
6 35 02 219 21 0	4014586391038	Diamond-coated saw blade round SLM Ø 105 x 1,2 (1)	94.70	04	166
6 35 02 219 23 0	4014586391045	Diamond-coated saw blade round SLM Ø 105 x 1,2 (5)	426.14	04	166
6 35 02 220 21 0	4014586391052	Diamond-coated saw blade segmented SLM Ø 105 x 1,2	107.73	04	162



Part number	EAN	Description	£ List Price excl. VAT	PC	Page
6 35 02 221 21 0	4014586400402	E-Cut long-life saw blade	13.55	04	160
6 35 02 221 22 0	4014586400419	E-Cut long-life saw blade	38.62	04	160
6 35 02 221 23 0	4014586400426	E-Cut long-life saw blade	61.04	04	160
6 35 02 221 24 0	4014586400433	E-Cut long-life saw blade	115.27	04	160
6 35 02 221 25 0	4014586400440	E-Cut long-life saw blade	549.12	04	160
6 35 02 222 21 0	4014586400457	E-Cut universal saw blade	14.25	04	162
6 35 02 222 22 0	4014586400464	E-Cut universal saw blade	40.66	04	162
6 35 02 222 23 0	4014586400471	E-Cut universal saw blade	64.16	04	162
6 35 02 222 24 0	4014586400488	E-Cut universal saw blade	121.19	04	162
6 35 02 222 25 0	4014586400495	E-Cut universal saw blade	577.63	04	162
6 35 02 223 21 0	4014586400501	E-Cut universal saw blade	14.81	04	162
6 35 02 223 22 0	4014586400518	E-Cut universal saw blade	42.23	04	162
6 35 02 223 23 0	4014586400525	E-Cut universal saw blade	66.68	04	162
6 35 02 223 24 0	4014586400532	E-Cut universal saw blade	125.94	04	162
6 35 02 223 25 0	4014586400549	E-Cut universal saw blade	600.06	04	162
6 35 02 224 21 0	4014586408170	E-Cut Long-Life saw blade SLM 90 x 32 (1)	13.92	04	-
6 35 02 224 22 0	4014586408187	E-Cut Long-Life saw blade SLM 90 x 32 (3)	39.69	04	-
6 35 02 224 23 0	4014586408194	E-Cut Long-Life saw blade SLM 90 x 32 (5)	62.66	04	-
6 35 02 224 24 0	4014586408200	E-Cut Long-Life saw blade SLM 90 x 32 (10)	118.35	04	-
6 35 02 224 25 0	4014586408217	E-Cut Long-Life saw blade SLM 90 x 32 (50)	563.75	04	-
6 35 02 225 21 0	4014586408262	E-Cut Standard saw blade curved SL 50 x 65 (1)	11.91	04	161
6 35 02 225 22 0	4014586408279	E-Cut Standard saw blade curved SL 50 x 65 (3)	33.95	04	161
6 35 02 225 23 0	4014586408286	E-Cut Standard saw blade curved SL 50 x 65 (5)	53.61	04	161
6 35 02 225 24 0	4014586408293	E-Cut Standard saw blade curved SL 50 x 65 (10)	101.26	04	161
6 35 02 225 25 0	4014586408309	E-Cut Standard saw blade curved SL 50 x 65 (50)	482.49	04	161
6 35 02 226 21 0	4014586408354	E-Cut Standard saw blade curved SL 50 x 50 (1)	11.50	04	161
6 35 02 226 22 0	4014586408361	E-Cut Standard saw blade curved SL 50 x 50 (3)	32.76	04	161
6 35 02 226 23 0	4014586408378	E-Cut Standard saw blade curved SL 50 x 50 (5)	51.73	04	161
6 35 02 226 24 0	4014586408385	E-Cut Standard saw blade curved SL 50 x 50 (10)	97.71	04	161
6 35 02 226 25 0	4014586408392	E-Cut Standard saw blade curved SL 50 x 50 (50)	465.56	04	161
6 35 02 227 21 0	4014586408446	E-Cut Standard saw blade curved SL 50 x 35 (1)	11.03	04	161
6 35 02 227 22 0	4014586408453	E-Cut Standard saw blade curved SL 50 x 35 (3)	31.42	04	161
6 35 02 227 23 0	4014586408460	E-Cut Standard saw blade curved SL 50 x 35 (5)	49.62	04	161
6 35 02 227 24 0	4014586408477	E-Cut Standard saw blade curved SL 50 x 35 (10)	93.72	04	161
6 35 02 227 25 0	4014586408484	E-Cut Standard saw blade curved SL 50 x 35 (50)	483.43	04	161
6 35 02 228 21 0	4014586408538	E-Cut Long-Life saw blade SL 50 x 65 (1)	12.63	04	160
6 35 02 228 22 0	4014586408545	E-Cut Long-Life saw blade SL 50 x 65 (3)	36.01	04	160
6 35 02 228 23 0	4014586408552	E-Cut Long-Life saw blade SL 50 x 65 (5)	56.86	04	160
6 35 02 228 24 0	4014586408569	E-Cut Long-Life saw blade SL 50 x 65 (10)	107.40	04	160
6 35 02 228 25 0	4014586408576	E-Cut Long-Life saw blade SL 50 x 65 (50)	511.70	04	160
6 35 02 229 21 0	4014586408620	E-Cut Precision BIM saw blade SL 50 x 65 (1)	13.10	04	161
6 35 02 229 22 0	4014586408637	E-Cut Precision BIM saw blade SL 50 x 65 (3)	37.35	04	161
6 35 02 229 23 0	4014586408644	E-Cut Precision BIM saw blade SL 50 x 65 (5)	58.97	04	161
6 35 02 229 24 0	4014586408651	E-Cut Precision BIM saw blade SL 50 x 65 (10)	111.39	04	161
6 35 02 229 25 0	4014586408668	E-Cut Precision BIM saw blade SL 50 x 65 (50)	530.74	04	161
6 35 02 230 21 0	4014586408712	E-Cut Precision saw blade SL 50 x 65 (1)	12.63	04	161
6 35 02 230 22 0	4014586408729	E-Cut Precision saw blade SL 50 x 65 (3)	36.01	04	161
6 35 02 230 23 0	4014586408736	E-Cut Precision saw blade SL 50 x 65 (5)	56.86	04	161
6 35 02 230 24 0	4014586408743	E-Cut Precision saw blade SL 50 x 65 (10)	107.40	04	161
6 35 02 230 25 0	4014586408750	E-Cut Precision saw blade SL 50 x 65 (50)	511.70	04	161
6 35 02 231 21 0	4014586408804	E-Cut Standard saw blade SLM 90 x 32 (1)	12.26	04	-
6 35 02 231 22 0	4014586408811	E-Cut Standard saw blade SLM 90 x 32 (3)	34.95	04	-
6 35 02 231 23 0	4014586408828	E-Cut Standard saw blade SLM 90 x 32 (5)	55.18	04	-
6 35 02 231 24 0	4014586408835	E-Cut Standard saw blade SLM 90 x 32 (10)	104.22	04	-
6 35 02 231 25 0	4014586408842	E-Cut Standard saw blade SLM 90 x 32 (50)	496.46	04	-
6 35 02 232 21 0	4014586417295	E-Cut precision BIM saw blade SL 50 x 50	14.22	04	161
6 35 02 232 22 0	4014586417301	E-Cut precision BIM saw blade SL 50 x 50	40.53	04	161
6 35 02 232 23 0	4014586417318	E-Cut precision BIM saw blade SL 50 x 50	63.99	04	161
6 35 02 232 24 0	4014586417325	E-Cut precision BIM saw blade SL 50 x 50	120.87	04	161
6 35 02 232 25 0	4014586417332	E-Cut precision BIM saw blade SL 50 x 50	568.80	04	161
6 35 02 233 21 0	4014586417387	E-Cut Precision saw blade SL 50 x 50	12.93	04	161
6 35 02 233 22 0	4014586417394	E-Cut Precision saw blade SL 50 x 50	36.85	04	161
6 35 02 233 23 0	4014586417400	E-Cut Precision saw blade SL 50 x 50	58.19	04	161
6 35 02 233 24 0	4014586417417	E-Cut Precision saw blade SL 50 x 50	109.91	04	161
6 35 02 233 25 0	4014586417424	E-Cut Precision saw blade SL 50 x 50	517.20	04	161
6 35 03 035 01 1	4014586178912	HSS saw blade pack of 5	10.09	02	-
6 35 03 036 01 4	4014586178929	Saw blades, 5-pack	10.09	02	-
6 35 03 037 01 8	4014586178936	Saw blades, 5-pack	10.09	02	-
6 35 03 038 01 6	4014586178943	Saw blades, 5-pack	10.09	02	-
6 35 03 039 01 0	4014586178950	Saw blades, 5-pack	12.75	02	-
6 35 03 040 00 3	4014586178967	Saw blade	15.13	02	-
6 35 03 042 01 4	4014586178998	Saw blades, 3-pack	13.74	02	-
6 35 03 043 01 8	4014586179001	Saw blades, 3-pack	13.74	02	-
6 35 03 047 01 7	4014586179049	Saw blades, 3-pack	17.31	02	-
6 35 03 048 01 5	4014586179056	Saw blades, 3-pack	17.31	02	-
6 35 03 051 01 0	4014586179087	Saw blades, 3-pack	25.11	02	-
6 35 03 058 01 4	4014586179148	Saw blades, 3-pack	24.45	02	-

Accessories in numerical order

Part number	EAN	Description	£ List Price excl, VAT	PC	Page
6 35 03 059 01 8	4014586179155	Saw blades, 3-pack	24.62	02	-
6 35 03 060 01 0	4014586179162	Saw blades, 5-pack	16.86	02	-
6 35 03 061 01 9	4014586179186	Saw blade	46.94	02	-
6 35 03 063 00 7	4014586179209	HSS saw blade	10.67	02	-
6 35 03 064 00 5	4014586179216	HSS saw blade	16.77	02	-
6 35 03 065 00 9	4014586179223	HSS saw blade	7.86	02	-
6 35 03 066 00 2	4014586179230	HSS saw blade	9.65	02	-
6 35 03 067 00 6	4014586179247	HSS saw blade	10.01	02	-
6 35 03 068 00 4	4014586179254	HSS saw blade	16.77	02	-
6 35 03 069 00 8	4014586179261	HSS saw blade	21.79	02	-
6 35 03 070 00 0	4014586179278	HSS saw blade	11.98	02	-
6 35 03 071 00 9	4014586179285	Saw blade	8.46	02	-
6 35 03 072 00 2	4014586179292	HSS saw blade	27.20	02	-
6 35 03 073 00 6	4014586179308	HSS saw blade	41.50	02	-
6 35 03 076 01 0	4014586179339	Saw blades, 5-pack	15.91	02	-
6 35 03 077 01 4	4014586179346	Saw blades, 5-pack	20.63	02	-
6 35 03 082 01 0	4014586179360	Saw blades, 5-pack	13.39	02	-
6 35 03 087 01 3	4014586179391	Saw blades, 5-pack	10.09	02	-
6 35 03 088 01 1	4014586179407	Saw blades, 5-pack	12.77	02	-
6 35 03 089 01 5	4014586179414	Saw blades, 5-pack	34.00	02	-
6 35 03 093 00 4	4014586200774	HD saw blade	21.59	02	-
6 35 03 094 00 2	4014586200781	HD saw blade	28.86	02	-
6 35 03 095 00 6	4014586200798	HD saw blade	28.86	02	-
6 35 03 096 01 8	4014586202921	TD saw blade	190.83	02	-
6 35 03 097 01 2	4014586202938	TD saw blade	252.95	02	-
6 35 03 098 00 1	4014586212548	Saw blade	48.68	02	-
6 35 03 099 00 5	4014586212555	Saw blade	39.79	02	-
6 35 03 100 00 6	4014586212562	Saw blade	31.08	02	-
6 35 03 112 01 0	4014586305370	Saw blades, 5-pack	15.74	02	-
6 35 03 113 01 0	4014586305387	Saw blades, 5-pack	15.74	02	-
6 35 03 114 01 0	4014586305394	Saw blades, 5-pack	28.41	02	-
6 35 03 115 01 0	4014586305417	Saw blade, 3-pack	13.32	02	-
6 35 03 116 01 0	4014586305424	Saw blade, 3-pack	13.32	02	-
6 35 03 123 01 0	4014586305431	Saw blade, 3-pack	16.82	02	-
6 36 01 101 00 9	4014586179766	1 pair of blades	25.25	02	77
6 36 02 001 00 4	4014586179797	Cutter blades, up to 2.0 mm	11.21	02	-
6 36 02 046 00 2	4014586179834	Cutter blades, up to 2.0 mm	19.49	02	-
6 36 02 048 00 4	4014586224053	Punch	18.41	02	82
6 36 02 048 01 3	4014586246260	Punches and dies	68.34	02	82
6 36 02 048 04 0	4014586317984	Punch (5 ea)	87.36	02	82
6 36 02 048 05 0	4014586317991	Punch VE10	152.18	02	82
6 36 02 049 00 8	4014586246611	Punch	64.72	02	82
6 36 02 049 01 7	4014586246628	Punches and dies	150.16	02	82
6 36 02 049 04 0	4014586318004	Punch (2 ea)	116.95	02	82
6 36 02 049 05 0	4014586318011	Punch (5 ea)	259.22	02	82
6 36 02 050 00 0	4014586264370	Punch	16.26	02	83
6 36 02 050 01 0	4014586269511	Punch VE10	135.24	02	83
6 36 02 050 03 0	4014586318028	Punch (5 ea)	77.50	02	83
6 36 02 051 00 9	4014586262987	Punch	55.43	02	83
6 36 02 051 01 8	4014586264356	Punch set	113.04	02	83
6 37 06 012 02 4	4014586260884	Diamond file insert (20 mm), regular	11.54	04	-
6 37 06 015 01 0	4014586290423	Carbide file	5.82	04	-
6 37 06 018 01 0	4014586304922	HM file FSC 2 pcs	24.23	04	173
6 37 06 019 21 0	4014586389639	Carbide file SLP 30 x 10	19.18	04	167
6 37 07 008 00 2	4014586180373	Grinding wheel	12.50	02	-
6 37 13 007 00 9	4014586180717	Grinding wheel	105.77	02	-
6 37 13 008 00 7	4014586180724	Grinding wheel	105.77	02	-
6 37 13 009 00 1	4014586180731	Grinding wheel	105.77	02	-
6 37 13 010 00 3	4014586180748	Grinding wheel	118.68	02	-
6 37 13 011 00 2	4014586180755	Polishing wheel	124.13	02	-
6 37 13 013 01 8	4014586226811	Polishing wheel	138.77	02	141
6 37 13 015 01 0	4014586226835	Polishing wheel	138.77	02	142
6 37 13 016 01 3	4014586226842	Polishing wheel	138.77	02	142
6 37 14 004 00 5	4014586180779	Linen sanding belt	3.23	02	-
6 37 14 005 00 9	4014586180786	Linen sanding belt	3.23	02	-
6 37 14 006 00 2	4014586180793	Linen sanding belt	3.23	02	-
6 37 14 007 00 6	4014586180809	Linen sanding belt	2.85	02	-
6 37 14 008 00 4	4014586180816	Linen sanding belt	2.85	02	-
6 37 14 009 00 8	4014586180823	Linen sanding belt	2.85	02	-
6 37 14 010 00 0	4014586180830	Linen sanding belt	2.85	02	-
6 37 14 011 00 9	4014586180847	Linen sanding belt	4.26	02	-
6 37 14 012 00 2	4014586180854	Linen sanding belt	3.86	02	-
6 37 14 013 00 6	4014586180861	Linen sanding belt	3.86	02	-
6 37 14 014 00 4	4014586180878	Linen sanding belt	3.61	02	-
6 37 14 015 00 8	4014586180885	Linen sanding belt	3.61	02	-
6 37 14 026 00 0	4014586180960	Linen sanding belt	3.61	02	-
6 37 14 027 00 4	4014586180977	Linen sanding belt	3.61	02	-



Part number	EAN	Description	£ List Price excl. VAT	PC	Page
6 37 14 044 01 0	4014586246406	Grinding belt K60 VE10	24.04	02	141
6 37 14 045 01 4	4014586246413	Grinding belt K120 VE10	24.04	02	141
6 37 14 046 01 7	4014586246420	Grinding belt K240 10/pack	24.04	02	141
6 37 14 047 01 1	4014586246437	Fleece belt, coarse	12.85	02	141
6 37 14 048 01 9	4014586246444	Fleece belt, medium	12.85	02	141
6 37 14 049 01 3	4014586246451	Fleece belt, fine	12.85	02	141
6 37 14 050 01 5	4014586259444	Grinding belt K120 VE10	34.04	02	136
6 37 14 050 02 1	4014586259451	Basic set	225.93	02	135
6 37 14 051 01 4	4014586259468	Grinding belt K180 VE10	34.04	02	136
6 37 14 052 01 7	4014586259475	Grinding belt K320 VE10	34.04	02	136
6 37 14 052 02 3	4014586259482	Polishing-set	185.56	02	136
6 37 14 053 01 1	4014586259499	Grinding belt K400 VE10	34.04	02	136
6 37 14 054 01 9	4014586259505	Grinding belt K120 VE10	55.88	02	136
6 37 14 055 01 3	4014586259512	Grinding belt K180 VE10	55.88	02	136
6 37 14 056 01 6	4014586259529	Fleece belt, K80, 5-pack	39.30	02	136
6 37 14 057 01 0	4014586259536	Fleece belt K120, 5-pack	39.30	02	136
6 37 14 058 01 8	4014586259543	Fleece belt K280, 5-pack	46.06	02	136
6 37 14 061 01 0	4014586313160	Grinding belt K80 VE10	15.18	02	136
6 37 14 062 01 0	4014586313177	Grinding belt K120 VE10	15.18	02	136
6 37 14 063 01 0	4014586313184	Grinding belt K180 VE10	15.18	02	136
6 37 14 068 01 0	4014586313191	Grinding belt K80 VE10	16.83	02	136
6 37 14 069 01 0	4014586313207	Grinding belt K120 VE10	16.83	02	136
6 37 14 070 01 0	4014586313214	Grinding belt K180 VE10	16.83	02	136
6 37 14 089 01 0	4014586313221	Grinding belt K80 VE10	23.20	02	136
6 37 14 090 01 0	4014586313238	Grinding belt K120 VE10	23.20	02	136
6 37 14 091 01 0	4014586313245	Grinding belt K180 VE10	23.20	02	136
6 37 14 114 01 0	4014586313252	Fleece belt, coarse VE5	21.45	02	136
6 37 14 115 01 0	4014586313269	Fleece belt, medium V5	21.45	02	136
6 37 14 116 01 0	4014586313276	Fleece belt, fine VE5	21.45	02	136
6 37 14 123 01 0	4014586313283	Fleece belt, coarse VE5	30.23	02	136
6 37 14 124 01 0	4014586313290	Fleece belt, medium V5	30.23	02	136
6 37 14 125 01 0	4014586313306	Fleece belt, fine VE5	30.23	02	136
6 37 14 130 01 0	4014586300849	Ceramic grinding belt	49.05	02	136
6 37 14 131 01 0	4014586300856	Ceramic grinding belt	77.04	02	136
6 37 14 132 01 0	4014586305264	Grinding sleeve K60 VE5	12.53	02	142
6 37 14 133 01 0	4014586305271	Grinding sleeve K80 VE5	12.20	02	142
6 37 14 134 01 0	4014586306674	Grinding sleeve K120 VE5	11.71	02	142
6 37 14 136 01 0	4014586329512	Grinding belt K80 VE10	27.15	02	138
6 37 14 137 01 0	4014586329529	Grinding belt K120 VE10	27.15	02	138
6 37 14 138 01 0	4014586329536	Grinding belt K180 VE10	27.15	02	138
6 37 14 139 01 0	4014586329543	Grinding belt K320 VE10	26.61	02	138
6 37 14 140 01 0	4014586329741	Grinding belt K400 VE10	26.61	02	138
6 37 14 141 01 0	4014586329550	Fleece belt, coarse VE5	37.15	02	138
6 37 14 142 01 0	4014586329567	Fleece belt, medium V5	37.15	02	138
6 37 14 143 01 0	4014586329574	Fleece belt, fine VE5	37.15	02	138
6 37 14 144 01 0	4014586330013	Polishing belt, 3-pack	21.59	02	138
6 37 14 145 01 0	4014586409672	Pyramix sanding sleeve	11.69	02	142
6 37 14 146 01 0	4014586409689	Pyramix sanding sleeve	11.69	02	142
6 37 14 147 01 0	4014586409696	Pyramix sanding sleeve	11.69	02	142
6 37 14 148 01 0	4014586409702	Pyramix sanding sleeve	11.69	02	142
6 37 16 066 01 1	4014586181905	Sanding sheet K60 VE50	54.16	02	-
6 37 17 081 01 8	4014586182575	Sanding sheets K40, 50/pack	17.48	04	163
6 37 17 081 04 6	4014586211114	Sanding sheets K40, 5/pack	4.21	04	163
6 37 17 082 01 1	4014586182612	Sanding sheets K60, 50/pack	17.48	04	163
6 37 17 082 03 3	4014586207667	Set of sanding sheets	17.48	04	163
6 37 17 082 04 9	4014586211121	Sanding sheets K60, 5/pack	4.21	04	163
6 37 17 083 01 5	4014586182643	Sanding sheets K80, 50/pack	17.48	04	163
6 37 17 083 04 3	4014586211138	Sanding sheets K80, 5/pack	4.21	04	163
6 37 17 084 01 3	4014586182674	Sanding sheets K100, 50/pack	17.48	04	163
6 37 17 084 04 1	4014586211145	Sanding sheets K100, 5/pack	4.21	04	163
6 37 17 085 01 7	4014586182704	Sanding sheets K120, 50/pack	17.48	04	163
6 37 17 085 04 5	4014586211152	Sanding sheets K120, 5/pack	4.21	04	163
6 37 17 086 01 0	4014586182728	Sanding sheets K36, 50/pack	25.37	04	163
6 37 17 086 04 8	4014586211107	Sanding sheets K36, 5/pack	4.53	04	163
6 37 17 087 01 4	4014586182742	Sanding sheets K150, 50/pack	17.48	04	163
6 37 17 087 04 2	4014586211169	Sanding sheets K150, 5/pack	4.21	04	163
6 37 17 088 01 2	4014586182773	Sanding sheets K180, 50/pack	17.48	04	163
6 37 17 088 04 0	4014586211176	Sanding sheets K180, 5/pack	4.21	04	163
6 37 17 089 01 6	4014586182797	Sanding sheets K220, 50/pack	17.48	04	163
6 37 17 089 04 4	4014586211183	Sanding sheets K220, 5/pack	4.21	04	163
6 37 17 090 01 8	4014586182810	Sanding sheets K240, 50/pack	17.48	04	163
6 37 17 090 04 6	4014586211190	Sanding sheets K240, 5/pack	4.21	04	163
6 37 17 107 01 1	4014586182896	Sanding sheets, perforated, K36, 50/pack	29.11	04	164
6 37 17 107 04 9	4014586211237	Sanding sheets, perforated, K36, 5/pack	5.40	04	164
6 37 17 108 01 9	4014586182919	Sanding sheets, perforated, K40, 50/pack	18.73	04	164
6 37 17 108 04 7	4014586211244	Sanding sheets, perforated, K40, 5/pack	4.53	04	164
6 37 17 109 01 3	4014586182933	Sanding sheets, perforated, K60, 50/pack	18.73	04	164

Accessories in numerical order

Part number	EAN	Description	£ List Price excl, VAT	PC	Page
6 37 17 109 03 5	4014586213002	Set of sanding sheets	18.73	04	164
6 37 17 109 04 1	4014586211251	Sanding sheets, perforated, K60, 5/pack	4.53	04	164
6 37 17 110 01 5	4014586182957	Sanding sheets, perforated, K80, 50/pack	18.73	04	164
6 37 17 110 04 3	4014586211268	Sanding sheets, perforated, K80, 5/pack	4.53	04	164
6 37 17 111 01 4	4014586182971	Sanding sheets, perforated, K100, 50/pack	18.73	04	164
6 37 17 111 04 2	4014586211275	Sanding sheets, perforated, K100, 5/pack	4.53	04	164
6 37 17 112 01 7	4014586182995	Sanding sheets, perforated, K120, 50/pack	18.73	04	164
6 37 17 112 04 5	4014586211282	Sanding sheets, perforated, K120, 5/pack	4.53	04	164
6 37 17 113 01 1	4014586183015	Sanding sheets, perforated, K150, 50/pack	18.73	04	164
6 37 17 113 04 9	4014586211299	Sanding sheets, perforated, K150, 5/pack	4.53	04	164
6 37 17 114 01 9	4014586183039	Sanding sheets, perforated, K180, 50/pack	18.73	04	164
6 37 17 114 04 7	4014586211305	Sanding sheets, perforated, K180, 5/pack	4.53	04	164
6 37 17 115 01 3	4014586183053	Sanding sheets, perforated, K220, 50/pack	18.73	04	164
6 37 17 115 04 1	4014586211312	Sanding sheets, perforated, K220, 5/pack	4.53	04	164
6 37 17 116 01 6	4014586183077	Sanding sheets, perforated, K240, 50/pack	18.73	04	164
6 37 17 116 04 4	4014586211329	Sanding sheets, perforated, K240, 5/pack	4.53	04	164
6 37 17 120 01 4	4014586183152	Stone sanding sheets, K40, 50/pack	20.03	04	164
6 37 17 121 01 3	4014586183176	Stone sanding sheets, K80, 50/pack	18.39	04	164
6 37 17 122 01 6	4014586183190	Stone sanding sheets, K120, 50/pack	17.89	04	164
6 37 17 123 01 0	4014586183213	Stone sanding sheets, K220, 50/pack	17.89	04	164
6 37 17 124 01 8	4014586183237	Stone sanding sheets, K320, 50/pack	17.89	04	164
6 37 17 125 01 2	4014586183251	Stone sanding sheets, K400, 50/pack	17.89	04	164
6 37 17 126 01 5	4014586183275	Supersoft sanding sheets, K240, 50/pack	18.26	04	163
6 37 17 127 01 9	4014586183299	Supersoft sanding sheets, K320, 50/pack	18.26	04	163
6 37 17 128 01 7	4014586183312	Supersoft sanding sheets, K400, 50/pack	18.26	04	163
6 37 17 175 01 7	4014586183343	Stone sanding sheets, K600, 50/pack	17.89	04	164
6 37 17 176 01 0	4014586183350	Stone sanding sheets, K800, 50/pack	17.89	04	164
6 37 17 179 01 6	4014586201375	Supersoft sanding sheets, K500, 50/pack	18.26	04	163
6 37 17 184 01 2	4014586208473	Sheets for sanding finger K40, 20/pack	5.85	04	164
6 37 17 185 01 6	4014586208480	Sheets for sanding finger K60, 20/pack	5.85	04	164
6 37 17 186 01 9	4014586208497	Sheets for sanding finger K80, 20/pack	5.85	04	164
6 37 17 187 01 3	4014586208503	Sheets for sanding finger K100, 20/pack	5.85	04	164
6 37 17 188 01 1	4014586208510	Sheets for sanding finger K120, 20/pack	5.85	04	164
6 37 17 189 01 5	4014586208527	Sheets for sanding finger K150, 20/pack	5.85	04	164
6 37 17 190 01 7	4014586208534	Sheets for sanding finger K180, 20/pack	5.85	04	164
6 37 17 191 01 6	4014586208541	Sheets for sanding finger K220, 20/pack	5.85	04	164
6 37 17 192 01 9	4014586208558	Sheets for sanding finger K240, 20/pack	5.85	04	164
6 37 17 217 01 6	4014586260914	Sanding sheets, profile grinding kit K80, 25/pack	9.43	04	164
6 37 17 218 01 4	4014586260921	Sanding sheets, profile grinding kit K120, 25/pack	9.43	04	164
6 37 17 219 01 8	4014586260938	Sanding sheets, profile grinding kit K180, 25/pack	9.43	04	164
6 37 17 221 01 0	4014586282893	Sanding disc, K2800, 53/pack	10.71	02	145
6 37 17 227 01 0	4014586317182	Set of sanding sheets	11.56	04	165
6 37 17 227 02 0	4014586317199	Abrasive disc K60 VE16	11.56	04	165
6 37 17 228 02 0	4014586317205	Abrasive disc K80 VE16	11.56	04	165
6 37 17 229 01 0	4014586317212	Abrasive disc K120 VE16	11.56	04	165
6 37 17 230 02 0	4014586317229	Abrasive disc K40 VE16	11.56	04	165
6 37 17 231 02 0	4014586317236	Abrasive disc K180 VE16	11.56	04	165
6 37 17 232 01 0	4014586317243	Abrasive disc K240 VE16	11.56	04	165
6 37 17 233 01 0	4014586329581	Abras.disc gr.40(12ea)	19.67	04	165
6 37 17 233 02 0	4014586329598	Set of sanding sheets	19.67	04	165
6 37 17 234 01 0	4014586329604	Abras.disc gr.60(12ea)	19.67	04	165
6 37 17 235 01 0	4014586329611	Abras.disc gr.80(12ea)	19.67	04	165
6 37 17 236 01 0	4014586329628	Sanding sheet zirconium K40 VE35	17.88	04	164
6 37 17 237 01 0	4014586329635	Abras.disc gr.60(35ea)	17.88	04	164
6 37 17 238 01 0	4014586329642	Abras.disc gr.80(35ea)	17.88	04	164
6 37 17 239 01 0	4014586328768	Pyramix sanding sheet K280 VE5	24.54	02	137
6 37 17 239 02 0	4014586328775	Pyramix sanding sheet K280 VE25	116.89	02	137
6 37 17 240 01 0	4014586328782	Pyramix sanding sheet K400 VE5	24.54	02	137
6 37 17 240 02 0	4014586328799	Pyramix sanding sheet K400 VE25	116.89	02	137
6 37 17 241 01 0	4014586328805	Pyramix sanding sheet K800 VE5	26.56	02	137
6 37 17 241 02 0	4014586328812	Pyramix sanding sheet K800 VE25	114.67	02	137
6 37 17 242 01 0	4014586328829	Pyramix sanding sheet K1400 VE5	24.54	02	137
6 37 17 242 02 0	4014586328836	Pyramix sanding sheet K1400 VE25	116.89	02	137
6 37 17 243 01 0	4014586329659	Abras.disc gr.40(35ea)	16.68	04	163
6 37 17 244 01 0	4014586329666	Abras.disc gr.60(35ea)	16.68	04	163
6 37 17 245 01 0	4014586329673	Abras.disc gr.80(35ea)	16.68	04	163
6 37 17 246 01 0	4014586373867	Sanding sheets, foam backing	14.81	04	168
6 37 17 247 01 0	4014586373874	Sanding sheets, foam backing	14.81	04	168
6 37 17 292 02 0	4014586399140	Sanding sheets, perforated	10.26	04	165
6 37 17 293 02 0	4014586399157	Sanding sheets, perforated	10.26	04	165
6 37 17 294 02 0	4014586399164	Sanding sheets, perforated	10.26	04	165
6 37 17 295 02 0	4014586399171	Sanding sheets, perforated	10.26	04	165
6 37 17 296 02 0	4014586399188	Sanding sheets, perforated	10.26	04	165
6 37 17 297 02 0	4014586399195	Sanding sheets, perforated	10.26	04	165
6 37 17 298 01 0	4014586401430	Sanding sheets, zirconium	17.10	04	165
6 37 17 299 01 0	4014586401447	Sanding sheets, zirconium	17.10	04	165
6 37 17 300 01 0	4014586401454	Sanding sheets, zirconium	17.10	04	165



Part number	EAN	Description	£ List Price excl. VAT	PC	Page
6 37 18 011 01 0	4014586334998	Polishing wheel 6 mm	16.60	02	138
6 37 19 007 01 0	4014586213101	Cleaning block	22.68	04	167
6 37 19 010 01 4	4014586213453	Sharpening stone	11.68	04	178
6 37 19 011 01 0	4014586336466	Profiling stone	20.95	02	138
6 37 19 011 22 0	4014586389646	1 Sanding plate with holes SLP (2)	25.31	04	166
6 37 21 001 00 1	4014586183428	Flap wheel	140.18	02	142
6 37 21 003 01 7	4014586226583	Abrasive fleece wheels	61.19	02	140
6 37 21 004 01 5	4014586226590	Abrasive fleece wheels	61.19	02	140
6 37 21 005 01 9	4014586226606	Abrasive fleece wheels	61.19	02	140
6 37 21 006 01 2	4014586246321	Elastic sanding cylinder	95.00	02	140
6 37 21 006 04 0	4014586306629	Standard stainless steel set for surfaces	219.53	02	140
6 37 21 007 01 6	4014586246338	Elastic sanding cylinder	95.00	02	140
6 37 21 008 01 4	4014586246345	Lamella fleece cylinder	41.33	02	141
6 37 21 009 01 8	4014586246352	Lamella fleece cylinder	41.33	02	141
6 37 21 010 01 0	4014586248448	Lamella fleece cylinder	41.33	02	141
6 37 21 015 01 0	4014586282329	Fleece 4" x 4"Gr.60/100	28.80	02	-
6 37 21 050 02 0	4014586306636	Stainless steel set for satin-finishing surfaces	235.37	02	140
6 37 21 051 01 0	4014586305288	Fleece wheel K180	54.22	02	140
6 37 21 052 01 0	4014586305189	Flap wheel K120	27.24	02	137
6 37 21 052 02 0	4014586306643	Stainless steel set for grinding pipes / profiles	248.18	02	138
6 37 21 054 01 0	4014586328843	Elastic sanding cylinder grit60	66.05	02	140
6 37 21 054 02 0	4014586328850	Stainless steel set for satin-finishing profiles	193.42	02	140
6 37 21 055 01 0	4014586328874	Elastic sanding cylinder grit180	66.05	02	140
6 37 21 056 01 0	4014586329062	Fleece wheel K180	38.28	02	140
6 37 21 057 01 0	4014586409917	Felt lamella roller	69.61	02	141
6 37 21 058 01 0	4014586409924	Felt lamella roller	69.61	02	141
6 37 22 048 01 4	4014586226736	Nylon barrel brush	42.66	02	146
6 37 23 003 00 3	4014586183633	Lambskin	16.64	02	147
6 37 23 007 00 2	4014586183688	Lambskin	8.92	02	146
6 37 23 008 00 0	4014586216720	Lambskin	8.61	02	140
6 37 23 009 00 4	4014586216737	Lambskin, 150 mm	11.06	02	139
6 37 23 010 00 6	4014586216744	Lambskin	18.54	02	139
6 37 23 011 01 4	4014586226637	Polishing ring, sisal	19.27	02	141
6 37 23 011 04 0	4014586306650	Stainless steel set for polishing surfaces / pipes / profiles	122.77	02	140
6 37 23 012 01 7	4014586226644	Polishing ring, sisal	26.92	02	141
6 37 23 013 01 1	4014586226651	Polishing ring, cloth	11.27	02	141
6 37 23 014 01 9	4014586226668	Polishing ring, cloth	8.80	02	141
6 37 23 015 01 3	4014586226675	Polishing ring, cloth	13.34	02	141
6 37 23 016 01 6	4014586226682	Polishing ring, cloth	12.82	02	141
6 37 23 017 01 0	4014586232829	Polishing sponge	14.69	02	145
6 37 23 018 01 8	4014586232836	Polishing sponge	16.51	02	145
6 37 23 019 01 2	4014586233710	Polishing rings, fleece, extra soft	10.73	02	141
6 37 23 020 01 4	4014586233727	Polishing rings, fleece, extra soft	16.80	02	141
6 37 23 021 01 3	4014586233734	Polishing ring, fleece	17.33	02	141
6 37 23 022 01 6	4014586233741	Polishing ring, fleece	20.51	02	141
6 37 23 023 01 0	4014586233918	Polishing sponge	21.59	02	145
6 37 23 024 01 8	4014586233925	Polishing sponge	21.15	02	145
6 37 23 025 01 2	4014586233932	Polishing sponge	26.93	02	147
6 37 23 026 01 5	4014586233949	Polishing sponge	26.93	02	147
6 37 23 028 01 0	4014586282909	Polishing sponge orange 150 mm	17.95	02	145
6 37 23 028 04 0	4014586327648	Paint refurbishing and finishing set	233.22	02	145
6 37 23 029 01 0	4014586282930	Waffled sponge 150 mm	16.59	02	145
6 37 23 031 01 0	4014586304939	Bristle fleece	11.09	04	167
6 37 23 032 01 0	4014586304946	Felt polishing pad	19.36	04	168
6 37 23 033 01 0	4014586304953	Bristle fleece 2ea	31.17	02	146
6 37 23 034 01 0	4014586304960	Polishing sponge 195 mm	19.92	02	146
6 37 23 035 01 0	4014586304977	Lamb's wool, dome shape	26.29	02	146
6 37 23 036 01 0	4014586335001	Felt polishing pad Ø 115mm pack of 5	21.46	04	168
6 37 23 037 01 0	4014586409931	Felt serrated disc	29.39	02	138
6 37 23 038 01 0	4014586409948	Felt serrated disc	29.39	02	138
6 37 26 008 01 2	4014586259550	Pre-polishing paste	29.69	02	135
6 37 26 009 01 6	4014586259567	Colouring paste	29.69	02	135
6 37 26 010 01 8	4014586259574	Polishing belt, 3-pack	66.60	02	136
6 37 26 014 01 0	4014586282978	FEIN single-stage polish	46.94	02	145
6 37 26 015 01 0	4014586282985	FEIN top wax paint seal	41.08	02	146
6 37 26 016 01 0	4014586313313	Polishing belts VE3	13.79	02	136
6 37 26 019 01 0	4014586313320	Polishing belts VE3	19.00	02	136
6 37 26 025 01 0	4014586327655	Wax sealing	20.52	02	145
6 37 26 027 01 0	4014586329963	Brushing paste	8.48	02	142
6 37 26 028 01 0	4014586329970	Preliminary polishing paste	8.48	02	142
6 37 26 029 01 0	4014586329987	Rumbling paste	8.48	02	142
6 37 26 030 01 0	4014586335018	Polishing agent 250 ml	20.66	02	168
6 37 28 001 01 6	4014586184340	Sanding sheet K80 VE50	38.02	02	139
6 37 28 002 01 9	4014586184364	Abras.disc gr.100 (50ea)	38.02	02	139
6 37 28 009 01 4	4014586184500	Sanding sheet K40 VE50	107.11	02	139
6 37 28 010 01 6	4014586184524	Sanding sheet K60 VE50	99.15	02	139
6 37 28 011 01 5	4014586184548	Abras.disc gr.100 (50ea)	42.91	02	-

Accessories in numerical order

Part number	EAN	Description	£ List Price excl, VAT	PC	Page
6 37 28 012 01 8	4014586184562	Sanding sheet K150 VE50	42.91	02	139
6 37 28 013 01 2	4014586184586	Sanding sheet K180 VE50	42.91	02	139
6 37 28 014 01 0	4014586184609	Sanding sheet K220 VE50	43.38	02	139
6 37 28 015 01 4	4014586184623	Abras.disc gr.240 (50ea)	42.91	02	139
6 37 28 017 01 1	4014586184661	Abras.disc gr.320 (50ea)	42.91	02	139
6 37 28 022 01 7	4014586184739	Sanding sheet K60 VE50	57.37	02	139
6 37 28 054 01 6	4014586185002	Abras.disc gr.100 (50ea)	91.00	02	139
6 37 28 056 01 3	4014586185040	Sanding sheet K80 VE50	90.10	02	139
6 37 28 061 01 0	4014586185101	Abras.disc gr.400 (50ea)	43.38	02	139
6 37 28 072 01 2	4014586185170	Sanding sheet K40 VE50	52.97	02	140
6 37 28 073 01 6	4014586185194	Sanding sheet K60 VE50	50.89	02	140
6 37 28 074 01 4	4014586185217	Sanding sheet K80 VE50	49.87	02	139
6 37 28 084 01 3	4014586185354	Sanding sheet K120 VE50	42.91	02	139
6 37 28 096 01 9	4014586215969	Sanding sheet K80 VE50	27.03	02	139
6 37 28 135 01 0	4014586329994	Sanding sheets	27.03	02	137
6 37 30 018 01 0	4014586305196	Abras.flap disc med.V10	195.91	02	137
6 37 30 019 01 0	4014586409719	Serrated sanding disc	93.57	02	137
6 37 30 020 01 0	4014586409726	Serrated sanding disc	93.57	02	137
6 37 30 021 01 0	4014586410296	Serrated sanding disc	93.57	02	137
6 37 31 001 21 0	4014586391069	Carbide rasp SL 80	24.63	04	166
6 37 31 002 21 0	4014586391076	Carbide rasp SLP	33.83	04	166
6 37 31 005 01 0	4014586348162	Carbide rasp, triangular	28.82	04	173
6 37 31 006 21 0	4014586391083	Carbide rasp SLM 110	29.80	04	166
6 37 32 001 01 8	4014586226781	Sanding fleece, coarse, 10/pack	39.28	02	137
6 37 32 002 01 1	4014586226798	Sanding fleece, medium, 10/pack	37.33	02	137
6 37 32 003 01 5	4014586226804	Sanding fleece, fine, 10/pack	31.98	02	137
6 37 32 004 01 0	4014586305493	Sanding fleece gr100 5e	22.76	02	146
6 37 32 005 01 0	4014586305202	Finishing disc	28.12	02	137
6 37 33 001 01 0	4014586282992	Humidification sponge	3.54	02	145
6 37 33 002 01 0	4014586283005	Sanding block	13.21	02	145
6 37 33 003 01 0	4014586283012	Microfiber chamois	8.26	02	135
6 37 33 005 01 0	4014586309569	Adapter FSC Qi	24.03	04	175
6 37 33 006 01 0	4014586307312	Holder	64.22	02	142
6 37 33 007 01 0	4014586327693	Cleaning putty	36.50	02	145
6 37 33 010 01 0	4014586409733	Stainless steel masking tape	57.83	02	135
6 37 34 001 01 0	4014586334868	Fleece disc, pressed 3 mm, coarse	31.75	02	138
6 37 34 002 01 0	4014586334875	Fleece disc, pressed 6 mm, coarse	39.88	02	138
6 37 34 003 01 0	4014586334882	Fleece disc, pressed 3 mm, medium	23.68	02	138
6 37 34 004 01 0	4014586334899	Fleece disc, pressed 6 mm, medium	29.02	02	138
6 37 34 005 01 0	4014586334905	Fleece disc, pressed 3 mm, fine	23.68	02	138
6 37 34 006 01 0	4014586334912	Fleece disc, pressed 6 mm, fine	29.02	02	138
6 37 34 007 01 0	4014586334929	Fleece disc, pressed 6 mm, very fine	25.67	02	138
6 37 34 008 01 0	4014586409740	Fleece disc	34.21	02	138
6 38 01 079 00 9	4014586185569	Inner flange	8.06	02	52
6 38 01 096 00 1	4014586185613	Inner flange	35.94	02	-
6 38 01 097 00 5	4014586185620	Inner flange	33.19	02	-
6 38 01 098 00 3	4014586185637	Inner flange	31.31	02	-
6 38 01 116 00 8	4014586185743	Flange	23.22	02	-
6 38 01 137 00 0	4014586185842	Inner flange	37.41	02	-
6 38 01 154 00 7	4014586185972	Threaded flange	7.65	02	137
6 38 01 176 01 1	4014586212517	Flange assy	7.65	02	-
6 38 01 178 00 4	4014586259857	adapter	24.97	02	-
6 38 01 181 00 0	4014586407883	Inner flange	18.29	02	-
6 38 01 182 01 0	4014586412405	Inner flange	8.20	02	136
6 38 01 183 01 0	4014586413662	Flange	8.06	02	-
6 38 02 052 00 0	4014586186115	Threaded flange	8.20	02	137
6 38 02 084 00 9	4014586186207	Threaded flange	8.06	02	52
6 38 02 098 00 7	4014586186238	Threaded flange	8.20	02	-
6 38 02 105 00 0	4014586186252	Threaded flange	23.65	02	-
6 38 02 106 00 3	4014586186269	Threaded flange	23.65	02	-
6 38 02 107 00 7	4014586186276	Threaded flange	31.58	02	-
6 38 02 178 02 3	4014586212890	Clamping unit	31.58	02	-
6 38 02 180 02 9	4014586212883	Clamping unit	38.14	02	-
6 38 02 182 00 6	4014586232805	Flange	35.89	02	-
6 38 02 183 02 5	4014586233314	Clamping unit	40.76	02	55
6 38 02 183 03 1	4014586233468	Clamping unit	39.99	02	-
6 38 02 185 02 7	4014586233321	Clamping unit	40.76	02	55
6 38 02 191 01 0	4014586356266	Fixtec quick-clamping nut	30.65	02	136
6 38 02 193 00 0	4014586407890	Threaded flange	18.29	02	-
6 38 03 027 03 8	4014586228136	Arbor ass.	33.01	02	142
6 38 03 066 02 4	4014586226613	Arbor ass.	36.69	02	142
6 38 03 067 02 8	4014586226729	Arbor ass.	57.31	02	142
6 38 03 068 02 0	4014586282350	Arbor ass.	56.23	02	-
6 38 03 069 02 0	4014586282367	Arbor ass.	35.97	02	-
6 38 03 071 02 0	4014586328898	Arbor ass.	49.37	02	142
6 38 06 012 00 8	4014586186801	Sanding pad	17.78	02	145
6 38 06 030 00 4	4014586186832	Sanding pad	25.08	02	147





Part number	EAN	Description	£ List Price excl. VAT	PC	Page
6 38 06 034 01 7	4014586186849	Elastic backing pad	13.07	02	55
6 38 06 076 00 1	4014586187006	Contact disc	127.71	02	-
6 38 06 077 00 5	4014586187013	Contact disc	143.31	02	-
6 38 06 087 01 3	4014586187112	Elastic backing pad	6.40	02	137
6 38 06 088 02 7	4014586187136	Sanding disc assy	75.44	02	139
6 38 06 090 02 3	4014586187174	Sanding disc assy	98.65	02	139
6 38 06 095 02 1	4014586187235	Sanding disc assy	119.74	02	139
6 38 06 101 02 0	4014586187358	Sanding disc assy	96.76	02	139
6 38 06 102 02 3	4014586187372	Sanding disc assy	120.14	02	139
6 38 06 103 02 7	4014586187396	Sanding disc assy	74.40	02	139
6 38 06 114 02 4	4014586187556	Sanding disc assy	90.75	02	139
6 38 06 116 02 1	4014586187594	Sanding disc assy	108.25	02	139
6 38 06 117 02 5	4014586187617	Sanding disc assy	96.29	02	139
6 38 06 118 02 3	4014586187631	Sanding disc assy	119.74	02	139
6 38 06 129 22 0	4014586391090	Sanding pad SL (2)	10.76	04	163
6 38 06 136 22 0	4014586391106	Sanding pad perforated SL (2)	16.50	04	164
6 38 06 138 01 5	4014586213798	Elastic backing pad	15.76	02	-
6 38 06 140 02 7	4014586187884	Set of felt polishing pads	31.41	04	-
6 38 06 140 22 0	4014586391113	Felt polishing pad SL (2)	29.18	04	168
6 38 06 141 22 0	4014586391120	Sanding pad super-soft version SL (2)	14.56	04	163
6 38 06 142 22 0	4014586391137	Sanding pad flat version SL (2)	14.56	04	163
6 38 06 143 00 8	4014586187921	Sanding pad	11.62	02	-
6 38 06 143 01 7	4014586212906	Elastic backing pad	11.83	02	-
6 38 06 159 22 0	4014586391144	Sanding pad finger shape SL (2)	11.55	04	164
6 38 06 166 02 6	4014586215990	Sanding pad	106.54	02	139
6 38 06 167 02 0	4014586216003	Sanding disc assy	39.19	02	139
6 38 06 168 01 2	4014586226569	Backing pad	11.83	02	137
6 38 06 169 01 6	4014586226743	Backing pad	14.77	02	145
6 38 06 170 01 8	4014586226750	Support plate, 150 mm	17.88	02	145
6 38 06 171 01 7	4014586226767	Backing pad	28.21	02	147
6 38 06 172 01 0	4014586226774	Backing pad	16.02	02	137
6 38 06 174 01 2	4014586233420	Sanding disc assy	18.38	02	55
6 38 06 174 02 8	4014586233437	Sanding disc assy	52.60	02	55
6 38 06 178 01 1	4014586233994	Backing pad	32.56	02	145
6 38 06 179 01 5	4014586233956	Backing pad	23.53	02	145
6 38 06 181 01 6	4014586246383	Sanding strip roll	79.44	02	141
6 38 06 181 03 0	4014586306698	Standard stainless steel set for pipes	155.95	02	140
6 38 06 183 01 3	4014586260945	Profile sanding set	45.15	04	-
6 38 06 184 01 0	4014586282381	Support plate assy	15.71	02	-
6 38 06 186 01 0	4014586299228	Backing pad	35.20	02	-
6 38 06 187 01 0	4014586304984	elastic disc 170 mm 5/8"	42.55	02	146
6 38 06 188 01 0	4014586304991	Pad 150 mm 5/8"	71.00	02	146
6 38 06 192 01 0	4014586305257	Expansion roller	182.20	02	142
6 38 06 192 02 0	4014586306704	Stainless steel set for grinding surfaces	221.09	02	140
6 38 06 193 01 0	4014586305363	Cool sanding pad	12.78	02	137
6 38 06 193 04 0	4014586328911	Stainless steel set - Preparing to polish surfaces / pipes / profiles	151.68	02	138
6 38 06 195 21 0	4014586391151	Sanding set SLP Ø 115	25.42	04	165
6 38 06 196 01 0	4014586328935	Cool sanding pad	12.55	02	137
6 38 06 198 01 0	4014586392394	Sanding pad	29.38	02	-
6 38 06 202 01 0	4014586392608	Sanding pad	29.38	02	-
6 38 06 204 21 0	4014586399201	Sanding set	28.49	04	164
6 38 09 004 01 9	4014586246468	Adhesive strip	11.78	02	141
6 38 10 011 01 6	4014586188133	Grinding arm	656.03	02	-
6 38 10 026 01 0	4014586313337	Grinding arm	72.39	02	136
6 38 10 027 01 0	4014586313344	Grinding arm	72.39	02	136
6 38 10 030 01 0	4014586313351	Grinding arm	94.63	02	136
6 38 10 031 01 0	4014586392912	Profile grinding set	44.30	04	164
6 38 11 004 01 0	4014586324838	Wheel guard cover for cutting work	34.16	02	55
6 38 11 005 01 0	4014586324845	Wheel guard cover for cutting work	35.26	02	55
6 38 11 008 01 0	4014586324852	Cutting-off-guard	46.44	02	-
6 38 11 009 01 0	4014586324869	Cutting-off-guard	49.95	02	-
6 38 11 010 01 0	4014586324876	Cutting-off-guard	57.78	02	-
6 38 11 016 01 0	4014586392400	Cutting-off-guard	31.31	02	52
6 38 11 017 01 0	4014586392417	Cutting-off-guard	31.31	02	136
6 38 11 018 01 0	4014586392424	Cutting-off-guard	31.31	02	52
6 39 01 011 06 2	4014586266961	Hand strap	7.01	02	-
6 39 01 015 00 5	4014586237558	Standard strip	12.26	02	-
6 39 01 017 01 1	4014586241791	Retainer shank QI assy	183.28	02	-
6 39 01 018 01 9	4014586241807	Retainer shank MK2 QI assy	183.28	02	119
6 39 01 019 01 3	4014586241814	Retainer shank MK3 QI assy	188.93	02	119
6 39 01 020 00 6	4014586241821	Adapter M18 x 6 P1.5	23.15	02	118
6 39 01 021 01 4	4014586241845	Adapter Weldon QI assy	23.15	02	118
6 39 01 022 00 8	4014586241852	Adapter QI 1/2"	23.15	02	118
6 39 01 023 00 2	4014586241869	Adapter B16	23.15	02	118
6 39 01 023 01 1	4014586258621	Jaw chuck till 16 mm with B16 adapter	88.88	02	118
6 39 01 023 02 0	4014586317960	Jaw chuck	74.97	02	118
6 39 01 024 01 9	4014586244433	Adapter Weldon QI ass. spec	23.15	02	118

Accessories in numerical order

Part number	EAN	Description	£ List Price excl, VAT	PC	Page
6 39 01 025 06 0	4014586289489	MINICUT and File set	37.49	04	-
6 39 01 027 01 0	4014586253480	Adapter Weldon/QuickIN	49.77	02	118
6 39 01 028 01 8	4014586254685	Adapter KBM 542 QuickIN	122.03	02	119
6 39 01 029 01 2	4014586258157	Hand strap assy	4.36	02	-
6 39 01 030 01 4	4014586262796	Autofeed screws 3.9 x 35 mm, metal, 1000/pack	51.45	02	41
6 39 01 030 02 0	4014586331928	Screws 3,9 x 35 (VE10 x 1000)	298.58	02	41
6 39 01 031 01 3	4014586262802	Autofeed screws 3.9 x 30 mm, wood, 1000/pack	51.45	02	41
6 39 01 031 02 0	4014586331935	Screws 3,9 x 30 (VE10 x 1000)	298.58	02	41
6 39 01 032 01 6	4014586262819	Autofeed screws 3.9 x 35 mm, wood, 1000/pack	51.45	02	41
6 39 01 032 02 0	4014586331942	Screws 3,9 x 35 (VE10 x 1000)	298.58	02	41
6 39 01 033 01 0	4014586262826	Autofeed screws 3.9 x 45 mm, wood, 1000/pack	67.03	02	41
6 39 01 033 02 0	4014586331959	Screws 3,9 x 45 (VE10 x 1000)	388.64	02	41
6 39 01 034 01 8	4014586262833	Autofeed screws 3.9 x 30 mm, wood/metal, 1000/pack	54.71	02	41
6 39 01 034 02 0	4014586331966	Screws 3,9 x 30 (VE10 x 1000)	388.64	02	41
6 39 01 035 01 2	4014586262840	Autofeed screws 4.2 x 35 mm, wood, 1000/pack	63.75	02	41
6 39 01 035 02 0	4014586331973	Screws 4,2 x 35 (VE10 x 1000)	376.86	02	41
6 39 01 036 01 0	4014586274096	Coolant tank assy	45.50	02	-
6 39 01 037 01 0	4014586274980	Contact and swarf guard assy	84.56	02	-
6 39 01 038 02 0	4014586298757	Taper shank M.T.3	261.27	02	122
6 39 01 038 03 0	4014586339054	Taper shank M.T.3	261.27	02	-
6 39 01 039 02 0	4014586310299	Taper shank M.T.3	178.32	02	122
6 39 01 040 01 0	4014586296647	Taper shank M.T.3	302.72	02	123
6 39 01 041 01 0	4014586296678	Taper shank M.T.3	308.56	02	122
6 39 01 042 01 0	4014586296685	Taper shank M.T.3	302.72	02	123
6 39 01 045 01 0	4014586317977	Adapter QIM/ QI	47.92	02	122
6 39 01 046 00 0	4014586329680	Clamping adapter for angled head	852.68	02	-
6 39 01 047 00 0	4014586336756	QuickIN PLUS adapter on B16	21.43	02	99
6 39 01 048 02 0	4014586355528	QuickIN-adaptors	169.32	02	118
6 39 01 049 02 0	4014586355535	QuickIN-adaptors	192.76	02	118
6 39 01 050 02 0	4014586355542	3/4" Weldon mounting shaft	183.28	02	118
6 39 01 051 02 0	4014586355559	3/4" Weldon mounting shaft	192.76	02	118
6 39 01 052 02 0	4014586355566	3/4" Weldon mounting shaft	188.93	02	119
6 39 01 053 02 0	4014586355573	3/4" Weldon mounting shaft	201.82	02	119
6 39 01 054 00 0	4014586365169	QuickIN Plus adapter for 1/2" UNF	22.77	02	99
6 39 01 054 01 0	4014586365176	Quick-action chucks	117.28	02	99
6 39 01 055 02 0	4014586371160	Retainer shank MK3 QI assy	201.82	02	119
6 39 01 057 02 0	4014586371122	Retainer shank MK2 QI assy	201.82	02	119
6 39 01 061 00 0	4014586369235	Adapter with 3/4" Weldon fitting	23.15	02	118
6 39 01 063 02 0	4014586403182	3/4" Weldon mounting shaft	169.35	02	118
6 39 01 064 02 0	4014586403199	3/4" Weldon mounting shaft	192.76	02	118
6 39 01 065 02 0	4014586403205	QuickIN-adaptors	179.86	02	118
6 39 01 066 02 0	4014586403212	QuickIN-adaptors	192.76	02	118
6 39 01 070 00 0	4014586407678	Adapter with 3/4" Weldon fitting	22.71	02	118
6 39 02 002 01 3	4014586188232	Paddle	92.08	02	9
6 39 03 072 01 7	4014586188577	Blade, curved, 2-pack	75.24	04	180
6 39 03 073 01 1	4014586188584	Cutter blade, straight, 2-pack	53.23	04	178
6 39 03 076 01 6	4014586188621	Blade, U-shape, 2-pack	75.31	04	179
6 39 03 076 04 0	4014586268965	Reciprocating blade 1ea	37.64	04	-
6 39 03 079 01 2	4014586188645	Blade, U-shape, 2-pack	75.31	04	179
6 39 03 081 01 3	4014586188676	Cutter blade, straight, 2-pack	75.21	04	179
6 39 03 082 01 6	4014586188683	Blade, curved, 2-pack	78.68	04	180
6 39 03 083 01 0	4014586188690	Blade, U-shape, 2-pack	78.68	04	179
6 39 03 087 01 9	4014586188737	Blade, U-shape, 2-pack	83.34	04	179
6 39 03 095 01 1	4014586188799	Blade, U-shape, 2-pack	81.86	04	179
6 39 03 097 01 8	4014586188829	Blade, straight, 2-pack	78.68	04	180
6 39 03 099 01 0	4014586188850	Blade, straight, 2-pack	77.28	04	180
6 39 03 101 01 0	4014586188874	Blade, U-shape, 2-pack	78.68	04	179
6 39 03 103 01 7	4014586188898	Blade, straight, 2-pack	46.82	04	180
6 39 03 104 01 5	4014586188904	Blade, straight, 2-pack	62.55	04	180
6 39 03 105 01 9	4014586188911	Scraper blade, 2-pack	69.42	04	179
6 39 03 107 01 6	4014586188935	Blade, U-shape, 2-pack	87.34	04	179
6 39 03 108 01 4	4014586188942	Blade, U-shape, 2-pack	92.56	04	179
6 39 03 109 01 8	4014586188959	Blade, straight, 2-pack	51.17	04	180
6 39 03 110 01 0	4014586188966	Blade, U-shape, 2-pack	83.34	04	179
6 39 03 111 01 9	4014586188973	Blade, U-shape, 2-pack	87.34	04	179
6 39 03 113 01 6	4014586188997	Reciprocating blades	69.42	04	179
6 39 03 113 02 2	4014586189000	Scraper blade kit, 2-pack mix	69.42	04	179
6 39 03 114 01 4	4014586189017	Blade, U-shape, 2-pack	92.56	04	179
6 39 03 115 01 8	4014586189031	Blade, U-shape, 2-pack	92.56	04	179
6 39 03 116 01 1	4014586189048	Cutter blade, 5-pack	74.14	04	174
6 39 03 117 01 5	4014586189055	Cutter blade, 5-pack	23.10	04	174
6 39 03 118 01 3	4014586189062	Blade, U-shape, 2-pack	85.82	04	179
6 39 03 120 01 9	4014586189086	Blade, straight, 2-pack	69.42	04	180
6 39 03 121 01 8	4014586189093	Blade, straight, 2-pack	69.42	04	180
6 39 03 122 01 1	4014586189109	Blade, straight, 2-pack	69.42	04	180
6 39 03 123 01 5	4014586189116	Blade, straight, 2-pack	80.94	04	180
6 39 03 124 01 3	4014586189123	Blade, straight, 2-pack	80.94	04	180



Part number	EAN	Description	£ List Price excl. VAT	PC	Page
6 39 03 125 01 7	4014586189130	Blade, straight, 2-pack	75.21	04	180
6 39 03 127 01 4	4014586189154	Blade, U-shape, 2-pack	90.96	04	179
6 39 03 128 01 2	4014586189161	Reciprocating blade	16.79	04	174
6 39 03 129 01 6	4014586189178	Scraper blade kit, 2-pack mix	68.21	04	179
6 39 03 129 05 0	4014586210636	Scraper blade, 2-pack	68.21	04	179
6 39 03 131 01 7	4014586210643	Scraper blade, 2-pack	68.21	04	179
6 39 03 132 01 0	4014586189208	Reciprocating blades	51.85	04	174
6 39 03 133 01 4	4014586189215	Blade, curved, 2-pack	77.28	04	180
6 39 03 143 01 3	4014586189314	Blade, straight, 2-pack	105.62	04	180
6 39 03 143 04 0	4014586268989	Reciprocating blade 1ea	51.60	04	-
6 39 03 144 01 1	4014586189321	Scraper blade, 2-pack	67.94	04	179
6 39 03 146 01 8	4014586189345	Scraper blade, 2-pack	69.16	04	179
6 39 03 147 01 2	4014586189352	Blade, U-shape, 2-pack	87.34	04	179
6 39 03 152 01 8	4014586189413	Blade, curved, 2-pack	78.68	04	180
6 39 03 153 01 2	4014586189420	Blade, U-shape, 2-pack	78.68	04	179
6 39 03 154 01 0	4014586189437	Blade, U-shape, 2-pack	83.34	04	179
6 39 03 154 03 0	4014586269016	Reciprocating blade 1ea	40.67	04	-
6 39 03 155 01 4	4014586189444	Blade, U-shape, 2-pack	87.34	04	179
6 39 03 156 01 7	4014586193939	Blade, U-shape, 2-pack	92.82	04	181
6 39 03 157 01 1	4014586195803	Blade, U-shape, 2-pack	78.68	04	179
6 39 03 160 01 5	4014586198781	Blade, straight, 2-pack	84.61	04	180
6 39 03 160 03 0	4014586269023	Reciprocating blade 1ea	41.34	04	-
6 39 03 161 01 4	4014586198934	Cleaning blades	84.89	04	-
6 39 03 161 03 0	4014586315072	Reciprocating blade	339.71	04	-
6 39 03 162 01 7	4014586198958	Reciprocating blade 1ea	80.79	04	174
6 39 03 162 03 0	4014586315089	Reciprocating blade	323.18	04	174
6 39 03 163 01 1	4014586200729	Blade, U-shape, 2-pack	83.34	04	179
6 39 03 165 21 0	4014586389653	1 Sanding plate with holes SL	8.05	04	167
6 39 03 166 01 6	4014586208862	Reciprocating blades	68.54	04	173
6 39 03 167 05 4	4014586210889	Blade kit, BMW	230.73	04	-
6 39 03 167 25 7	4014586240794	Set for automobiles/car glaziers	218.73	04	181
6 39 03 167 32 0	4014586252445	Blade, accessory kits for auto glaziers, cargo and automobile workshops, 2-pack	218.73	04	181
6 39 03 167 38 3	4014586265032	Automotive glazier set	218.73	04	181
6 39 03 167 40 2	4014586268170	Carpenters Set	111.74	04	-
6 39 03 167 58 0	4014586307503	Accessory set for tile restoration/bathroom renovation	185.17	04	175
6 39 03 167 59 0	4014586307510	Accessory set for heating/sanitary installation	185.17	04	175
6 39 03 167 66 0	4014586343549	Accessory set for interior construction work with wood	185.17	04	175
6 39 03 167 67 0	4014586343556	Accessory set for repairing/replacing windows	185.17	04	175
6 39 03 168 01 8	4014586210247	Blade, straight, 2-pack	75.21	04	180
6 39 03 169 01 2	4014586210261	Blade, straight, 2-pack	105.62	04	180
6 39 03 170 01 4	4014586210285	Blade, straight, 2-pack	103.80	04	180
6 39 03 171 01 3	4014586210308	Blade, straight, 2-pack	75.21	04	180
6 39 03 172 01 6	4014586211978	Blade, straight, 2-pack	52.05	04	180
6 39 03 173 01 0	4014586211985	Blade, straight, 2-pack	79.56	04	180
6 39 03 174 01 8	4014586213736	Blade, straight, 2-pack	80.94	04	180
6 39 03 176 01 5	4014586214245	Blade, straight, 2-pack	53.23	04	180
6 39 03 177 01 9	4014586214252	Blade, straight, 2-pack	77.07	04	180
6 39 03 181 01 2	4014586215785	Blade, straight, 2-pack	79.56	04	180
6 39 03 182 01 5	4014586216010	Blade, straight, 2-pack	87.34	04	180
6 39 03 183 01 9	4014586216539	Cutter blade, 2-pack	65.18	04	-
6 39 03 184 01 7	4014586216546	Cutter blade, 2-pack	65.18	04	-
6 39 03 185 01 1	4014586216553	Cutter blade, 2-pack	65.18	04	-
6 39 03 186 01 4	4014586216560	Cutter blade, 2-pack	65.18	04	-
6 39 03 191 01 1	4014586217376	Blade, U-shape, 2-pack	83.34	04	179
6 39 03 194 01 6	4014586221878	Blade, straight, 2-pack	87.34	04	180
6 39 03 194 03 0	4014586269030	Reciprocating blade 1ea	42.67	04	-
6 39 03 195 01 0	4014586223513	Blade, curved, 2-pack	105.62	04	180
6 39 03 196 01 3	4014586222974	Reciprocating blade 1ea	80.79	04	174
6 39 03 196 02 0	4014586315096	Reciprocating blade	323.18	04	174
6 39 03 197 01 7	4014586223506	Blade, straight, 2-pack	88.62	04	178
6 39 03 198 01 5	4014586223469	Blade, straight, 2-pack	105.62	04	180
6 39 03 200 21 0	4014586389660	Cutting blade SLP	32.85	04	167
6 39 03 201 21 0	4014586389677	Cutting blade SLP	32.85	04	167
6 39 03 202 21 0	4014586389684	Cutting blade SLP	32.85	04	167
6 39 03 203 01 3	4014586228488	Reciprocating blades	77.07	04	180
6 39 03 206 01 8	4014586240930	Squeegee, 2/pack	21.91	04	174
6 39 03 207 01 2	4014586240947	Blade, L-shape, 2-pack	53.53	04	179
6 39 03 208 01 0	4014586240954	Blade, L-shape, 2-pack	53.53	04	179
6 39 03 209 01 4	4014586245133	Blade, L-shape, 2-pack	53.53	04	179
6 39 03 210 01 6	4014586245140	Blade, U-shape, 2-pack	52.74	04	179
6 39 03 211 01 5	4014586245157	Blade, U-shape, 2-pack	52.74	04	179
6 39 03 212 01 8	4014586245164	Blade, U-shape, 2-pack	52.74	04	179
6 39 03 216 01 7	4014586258164	Cutter blade, straight, 2-pack	73.26	04	180
6 39 03 216 02 0	4014586324302	Reciprocating blade	1,798.88	04	-
6 39 03 217 01 1	4014586265810	Blade, hooked, 2-pack	52.74	04	181
6 39 03 221 01 0	4014586291970	Tilers cutting blade 2-pack	36.23	04	174
6 39 03 222 01 0	4014586293905	Tilers cutting blade 2-pack	36.23	04	174

Accessories in numerical order

Part number	EAN	Description	£ List Price excl, VAT	PC	Page
6 39 03 223 01 0	4014586293912	Tilers cutting blade 2-pack	36.23	04	174
6 39 03 224 01 0	4014586294223	HM Segment saw blade	43.52	04	173
6 39 03 224 02 0	4014586294247	HM Segment saw blade, 5-pack	174.00	04	173
6 39 03 225 01 0	4014586294254	HM Segment saw blade	43.52	04	173
6 39 03 225 02 0	4014586294261	HM Segment saw blade, 5-pack	174.00	04	173
6 39 03 226 21 0	4014586389691	Fixed Scraper Blade SL 34 x 52	14.49	04	167
6 39 03 227 01 0	4014586342078	Squeegee, 2/pack	22.24	04	174
6 39 03 228 01 0	4014586341507	Cutting tool	15.21	04	174
6 39 03 229 01 0	4014586341514	Cutting tool	15.21	04	174
6 39 03 230 01 0	4014586341521	Cutting tool	15.24	04	174
6 39 03 231 01 0	4014586341538	Cutting tool	15.24	04	174
6 39 03 233 21 0	4014586389707	Cutting blade SLP	32.85	04	167
6 39 03 234 21 0	4014586389714	Fixed Scraper Blade SLP 41 x 52	14.99	04	167
6 39 03 235 21 0	4014586389721	HSS circular knife SLP Ø 100	53.04	04	167
6 39 03 236 23 0	4014586389776	Cutting blade SLM 60 x 30 (5)	21.30	04	167
6 39 03 237 21 0	4014586391175	Diamond cleaning knife SLM 60 x 31 (1)	73.39	04	167
6 39 03 237 23 0	4014586391182	Diamond cleaning knife SLM 60 x 31 (5)	330.33	04	167
6 39 03 238 21 0	4014586389738	Cutting blade SLM 68 x 1 (1)	21.40	04	167
6 39 03 239 23 0	4014586389745	Cutting blade SLM 60 x 2 (5)	68.37	04	167
6 39 03 240 21 0	4014586391199	Carbide saw blade segmented SLM 1,2 (1)	37.60	04	166
6 39 03 240 23 0	4014586391205	Carbide saw blade segmented SLM 1,2 (5)	169.22	04	166
6 39 03 241 21 0	4014586391212	Carbide saw blade segmented SLM 2,2 (1)	37.60	04	166
6 39 03 241 23 0	4014586391229	Carbide saw blade segmented SLM 2,2 (5)	169.22	04	166
6 39 03 242 21 0	4014586391236	Diamond-coated saw blade segmented SLM 1,2 (1)	69.84	04	166
6 39 03 242 23 0	4014586391243	Diamond-coated saw blade segmented SLM 1,2 (5)	314.27	04	166
6 39 03 243 21 0	4014586391250	Diamond-coated saw blade segmented SLM 2,2 (1)	69.84	04	166
6 39 03 243 23 0	4014586391267	Diamond-coated saw blade segmented SLM 2,2 (5)	314.27	04	166
6 39 03 244 22 0	4014586389783	segmented segmented SLM 42,63 (2)	63.03	04	162
6 39 03 245 23 0	4014586389752	Cutting blade mushroom-shaped SL (5)	26.74	04	167
6 39 03 246 22 0	4014586392615	Cutting tool	50.15	04	167
6 39 03 247 22 0	4014586392622	Cutting tool	54.45	04	167
6 39 03 248 22 0	4014586392639	Cutting tool	50.15	04	167
6 39 03 251 21 0	4014586409276	SL Multi-function knife	20.95	04	167
6 39 03 251 23 0	4014586409283	SL Multi-function knife	94.28	04	167
6 39 98 611 03 0	4014586621241	Protecting lattice	29.27	02	-
6 40 01 010 00 2	4014586217314	Grinding gauge	18.85	02	-
6 41 31 019 01 0	4014586369877	Vice installation kit	29.38	02	14
6 42 01 001 00 0	4014586307305	Hook f. chip removal	41.53	02	-
6 42 01 005 01 0	4014586376554	Magbrush	49.78	02	107
6 42 03 001 00 0	4014586325118	Holder	5.16	02	-
6 42 03 002 01 0	4014586404844	Socket adapter	34.12	02	25
6 42 03 003 01 0	4014586404851	Tapping adapter	79.60	02	25
6 42 03 003 02 0	4014586414546	Tapping adapter	32.49	02	25
6 42 03 004 01 0	4014586404547	Extension	59.03	02	36
6 42 03 005 01 0	4014586404554	Extension	118.08	02	36
6 42 04 001 01 0	4014586351988	Cutting wire	37.47	02	-
6 42 04 002 01 0	4014586354354	Anti-Metal-Cut set	20.31	02	-
6 42 04 003 01 0	4014586371177	Extension	86.42	02	-
6 99 02 000 00 0	4014586277479	Dust collector	110.74	13	204
6 99 02 000 14 6	4014586330693	Pipe cleaning unit GIC	328.23	13	206
6 99 02 000 14 7	4014586364636	Device for dust extract	475.00	13	204
6 99 02 000 14 8	4014586369129	Stainless steel sanding support	191.92	13	205
6 99 02 000 14 9	4014586369136	Stainless steel sanding support	220.14	13	205
6 99 02 000 15 0	4014586369143	Mitre joint unit for preparation of welded seams	254.00	13	205
6 99 02 000 15 1	4014586369150	Mitre joint unit for preparation of welded seams	282.24	13	205
6 99 02 000 18 7	4014586372655	Contact roller Ø 193,7/150	569.67	13	205
6 99 02 000 40 9	4014586405292	Contact roller Ø 16,0 /50	70.00	13	187
6 99 02 000 41 0	4014586405308	Contact roller Ø 18,0 /50	70.00	13	187
6 99 02 000 41 1	4014586405315	Contact roller Ø 19,0 /50	70.00	13	187
6 99 02 000 41 2	4014586405322	Contact roller Ø 20,0 /50	70.00	13	187
6 99 02 000 41 3	4014586405339	Contact roller Ø 21,0 /50	70.00	13	187
6 99 02 000 41 4	4014586405346	Contact roller Ø 21,3 /50	70.00	13	187
6 99 02 000 41 5	4014586405353	Contact roller Ø 22,0 /50	70.00	13	187
6 99 02 000 41 6	4014586405360	Contact roller Ø 25,0 /50	70.00	13	187
6 99 02 000 41 7	4014586405377	Contact roller Ø 25,4 /50	70.00	13	187
6 99 02 000 41 8	4014586405384	Contact roller Ø 26,0 /50	70.00	13	187
6 99 02 000 41 9	4014586405391	Contact roller Ø 26,9 /50	70.00	13	187
6 99 02 000 42 0	4014586405407	Contact roller Ø 27,0 /50	70.00	13	187
6 99 02 000 42 1	4014586405414	Contact roller Ø 28,0 /50	70.00	13	187
6 99 02 000 42 2	4014586405421	Contact roller Ø 28,8 /50	70.00	13	187
6 99 02 000 42 3	4014586405438	Contact roller Ø 30,0 /50	70.00	13	187
6 99 02 000 42 4	4014586405445	Contact roller Ø 31,7 /50	70.00	13	187
6 99 02 000 42 5	4014586405452	Contact roller Ø 32,0 /50	70.00	13	187
6 99 02 000 42 6	4014586405469	Contact roller Ø 33,0 /50	70.00	13	187
6 99 02 000 42 7	4014586405476	Contact roller Ø 33,7 /50	70.00	13	187
6 99 02 000 42 8	4014586405483	Contact roller Ø 34,0 /50	70.00	13	187
6 99 02 000 42 9	4014586405490	Contact roller Ø 35,0 /50	70.00	13	187



Part number	EAN	Description	£ List Price excl. VAT	PC	Page
6 99 02 000 43 0	4014586405506	Contact roller Ø 38,0 /50	70.00	13	187
6 99 02 000 43 1	4014586405513	Contact roller Ø 38,1 /50	70.00	13	187
6 99 02 000 43 2	4014586405520	Contact roller Ø 38,3 /50	70.00	13	187
6 99 02 000 43 3	4014586405537	Contact roller Ø 40,0 /50	70.00	13	187
6 99 02 000 43 4	4014586405544	Contact roller Ø 42,0 /50	70.00	13	187
6 99 02 000 43 5	4014586405551	Contact roller Ø 42,4 /50	70.00	13	187
6 99 02 001 00 0	4014586277486	Length stop	191.00	13	203
6 99 02 002 00 0	4014586277493	Connector	104.36	02	-
6 99 02 004 00 0	4014586277516	Stainless steel jaws for GXR	177.39	06	203
6 99 02 006 00 0	4014586277530	Steel brush Ø250 x 60 x 34 x 0.2 mm	218.66	12	204
6 99 02 007 00 0	4014586277547	Steel brush Ø 250 x 60 x 34x 0.35 mm	200.00	12	204
6 99 02 008 00 0	4014586277554	Steel brush Ø 250 x 60 x 34x 0.5 mm	200.00	12	204
6 99 02 009 00 0	4014586277561	Stainless steel brush Ø250 x 60 x 34 x 0.2 mm	386.50	12	204
6 99 02 010 00 0	4014586277578	Stainless steel brush Ø 250 x 60 x 34x 0.35 mm	337.34	12	204
6 99 02 020 00 0	4014586277677	Contact roller Ø16.0 /75	124.00	13	203
6 99 02 021 00 0	4014586277684	Contact roller Ø17.0 /75	124.00	13	203
6 99 02 022 00 0	4014586277691	Contact roller Ø17.2 /75	114.03	13	203
6 99 02 023 00 0	4014586277707	Contact roller Ø18.0 /75	114.03	13	203
6 99 02 024 00 0	4014586277714	Contact roller Ø19.0 /75	124.00	13	203
6 99 02 025 00 0	4014586277721	Contact roller Ø20.0 /75	124.00	13	203
6 99 02 026 00 0	4014586277738	Contact roller Ø21.0 /75	124.00	13	203
6 99 02 027 00 0	4014586277745	Contact roller Ø 21.3 /75	114.03	13	203
6 99 02 028 00 0	4014586277752	Contact roller Ø22.0 /75	124.00	13	203
6 99 02 029 00 0	4014586277769	Contact roller Ø22.2 /75	124.00	13	203
6 99 02 030 00 0	4014586277776	Contact roller Ø22.5 /75	124.00	13	203
6 99 02 031 00 0	4014586277783	Contact roller Ø23.0 /75	114.03	13	203
6 99 02 032 00 0	4014586277790	Contact roller Ø23.1 /75	114.03	13	203
6 99 02 033 00 0	4014586277806	Contact roller Ø24.0 /75	114.03	13	203
6 99 02 034 00 0	4014586277813	Contact roller Ø24.5 /75	114.03	13	203
6 99 02 035 00 0	4014586277820	Contact roller Ø25.0 /75	124.00	13	203
6 99 02 036 00 0	4014586277837	Contact roller Ø25.4 /75	124.00	13	203
6 99 02 037 00 0	4014586277844	Contact roller Ø25.9 /75	114.03	13	203
6 99 02 038 00 0	4014586277851	Contact roller Ø26.0 /75	124.00	13	203
6 99 02 039 00 0	4014586277868	Contact roller Ø26.4 /75	114.03	13	203
6 99 02 040 00 0	4014586277875	Contact roller Ø26.9 /75	124.00	13	203
6 99 02 041 00 0	4014586277882	Contact roller Ø27.0 /75	114.03	13	203
6 99 02 042 00 0	4014586277899	Contact roller Ø28.0 /75	114.03	13	203
6 99 02 043 00 0	4014586277905	Contact roller Ø28.6 /75	124.00	13	203
6 99 02 044 00 0	4014586277912	Contact roller Ø28.8 /75	114.03	13	203
6 99 02 045 00 0	4014586277929	Contact roller Ø29.0 /75	114.03	13	203
6 99 02 046 00 0	4014586277936	Contact roller Ø30.0 /75	124.00	13	203
6 99 02 047 00 0	4014586277943	Contact roller Ø31.7 /75	124.00	13	203
6 99 02 048 00 0	4014586277950	Contact roller Ø32.0 /75	124.00	13	203
6 99 02 049 00 0	4014586277967	Contact roller Ø33.0 /75	124.00	13	203
6 99 02 050 00 0	4014586277974	Contact roller Ø33.7 /75	124.00	13	203
6 99 02 051 00 0	4014586277981	Contact roller Ø34.0 /75	114.03	13	203
6 99 02 052 00 0	4014586277998	Contact roller Ø35.0 /75	124.00	13	203
6 99 02 053 00 0	4014586278001	Contact roller Ø36.0 /75	124.00	13	203
6 99 02 054 00 0	4014586278018	Contact roller Ø37.5 /75	114.03	13	203
6 99 02 055 00 0	4014586278025	Contact roller Ø38.0 /75	124.00	13	203
6 99 02 056 00 0	4014586278032	Contact roller Ø38.1 /75	124.00	13	203
6 99 02 057 00 0	4014586278049	Contact roller Ø38.3 /75	114.03	13	203
6 99 02 058 00 0	4014586278056	Contact roller Ø40.0 /75	114.03	13	203
6 99 02 059 00 0	4014586278063	Contact roller Ø41.0 /75	114.03	13	203
6 99 02 060 00 0	4014586278070	Contact roller Ø41.2 /75	124.00	13	203
6 99 02 061 00 0	4014586278087	Contact roller Ø42.0 /75	124.00	13	203
6 99 02 062 00 0	4014586278094	Contact roller Ø42.4 /75	124.00	13	203
6 99 02 063 00 0	4014586278100	Contact roller Ø42.6 /75	114.03	13	203
6 99 02 064 00 0	4014586278117	Contact roller Ø43.0 /75	124.00	13	203
6 99 02 065 00 0	4014586278124	Contact roller Ø43.3 /75	114.03	13	203
6 99 02 066 00 0	4014586278131	Contact roller Ø44.0 /75	114.03	13	203
6 99 02 067 00 0	4014586278148	Contact roller Ø44.5 /75	124.00	13	203
6 99 02 068 00 0	4014586278155	Contact roller Ø45.0 /75	124.00	13	203
6 99 02 069 00 0	4014586278162	Contact roller Ø46.0 /75	114.03	13	203
6 99 02 070 00 0	4014586278179	Contact roller Ø48.0 /75	124.00	13	203
6 99 02 071 00 0	4014586278186	Contact roller Ø48.3 /75	124.00	13	203
6 99 02 072 00 0	4014586278193	Contact roller Ø49.0 /75	114.03	13	203
6 99 02 073 00 0	4014586278209	Contact roller Ø50.0 /75	124.00	13	203
6 99 02 074 00 0	4014586278216	Contact roller Ø50.8 /75	153.00	13	203
6 99 02 075 00 0	4014586278223	Contact roller Ø51.0 /75	153.00	13	203
6 99 02 076 00 0	4014586278230	Contact roller Ø53.0 /75	140.48	13	203
6 99 02 077 00 0	4014586278247	Contact roller Ø53.7 /75	140.48	13	203
6 99 02 078 00 0	4014586278254	Contact roller Ø54.0 /75	140.48	13	203
6 99 02 079 00 0	4014586278261	Contact roller Ø55.0 /75	153.00	13	203
6 99 02 080 00 0	4014586278278	Contact roller Ø57.0 /75	140.48	13	203
6 99 02 081 00 0	4014586278285	Contact roller Ø58.0 /75	140.48	13	203
6 99 02 082 00 0	4014586278292	Contact roller Ø59.0 /75	140.48	13	203

Accessories in numerical order

Part number	EAN	Description	£ List Price excl, VAT	PC	Page
6 99 02 083 00 0	4014586278308	Contact roller Ø60.0 /75	153.00	13	203
6 99 02 084 00 0	4014586278315	Contact roller Ø60.3 /75	153.00	13	203
6 99 02 085 00 0	4014586278322	Contact roller Ø63.0 /75	140.48	13	203
6 99 02 086 00 0	4014586278339	Contact roller Ø63.5 /75	153.00	13	203
6 99 02 087 00 0	4014586278346	Contact roller Ø65.0 /75	140.48	13	203
6 99 02 088 00 0	4014586278353	Contact roller Ø67.0 /75	140.48	13	203
6 99 02 089 00 0	4014586278360	Contact roller Ø69.0 /75	140.48	13	203
6 99 02 090 00 0	4014586278377	Contact roller Ø70.0 /75	153.00	13	203
6 99 02 091 00 0	4014586278384	Contact roller Ø73.0 /75	153.00	13	203
6 99 02 092 00 0	4014586278391	Contact roller Ø75.0 /75	153.00	13	203
6 99 02 093 00 0	4014586278407	Contact roller Ø76.0 /75	160.31	13	203
6 99 02 094 00 0	4014586278414	Contact roller Ø76.1 /75	160.31	13	203
6 99 02 095 00 0	4014586278421	Contact roller Ø76.2 /75	175.00	13	203
6 99 02 096 00 0	4014586278438	Contact roller Ø80.0 /75	160.31	13	203
6 99 02 097 00 0	4014586278445	Contact roller Ø82.5 /75	160.31	13	203
6 99 02 098 00 0	4014586278452	Contact roller Ø88.9 /75	160.31	13	203
6 99 02 099 00 0	4014586278469	Contact roller Ø90.0 /75	175.00	13	203
6 99 02 100 00 0	4014586278476	Grinding/cooling emulsion 10 litre	351.00	13	204
6 99 02 101 00 0	4014586283098	Contact roller Ø20.0 /150	163.64	13	205
6 99 02 102 00 0	4014586283104	Contact roller Ø22.0 /150	178.00	13	205
6 99 02 103 00 0	4014586283111	Contact roller Ø25.0 /150	178.00	13	205
6 99 02 104 00 0	4014586283128	Contact roller Ø25.4 /150	178.00	13	205
6 99 02 105 00 0	4014586283135	Contact roller Ø26.9 /150	163.64	13	205
6 99 02 106 00 0	4014586283142	Contact roller Ø28.0 /150	163.64	13	205
6 99 02 107 00 0	4014586283159	Contact roller Ø30.0 /150	178.00	13	205
6 99 02 108 00 0	4014586283166	Contact roller Ø32.0 /150	178.00	13	205
6 99 02 109 00 0	4014586283173	Contact roller Ø33.7 /150	178.00	13	205
6 99 02 110 00 0	4014586283180	Contact roller Ø35.0 /150	163.64	13	205
6 99 02 111 00 0	4014586283197	Contact roller Ø38.0 /150	178.00	13	205
6 99 02 112 00 0	4014586283203	Contact roller Ø38.1 /150	178.00	13	205
6 99 02 113 00 0	4014586283210	Contact roller Ø38.3 /150	163.64	13	205
6 99 02 114 00 0	4014586283227	Contact roller Ø40.0 /150	163.64	13	205
6 99 02 115 00 0	4014586283234	Contact roller Ø42.4 /150	178.00	13	205
6 99 02 116 00 0	4014586283241	Contact roller Ø44.5 /150	178.00	13	205
6 99 02 117 00 0	4014586283258	Contact roller Ø48.3 /150	178.00	13	205
6 99 02 118 00 0	4014586283265	Contact roller Ø50.0 /150	178.00	13	205
6 99 02 119 00 0	4014586283272	Contact roller Ø50.8 /150	204.00	13	205
6 99 02 120 00 0	4014586283289	Contact roller Ø60.0 /150	204.00	13	205
6 99 02 121 00 0	4014586283296	Contact roller Ø60.3 /150	204.00	13	205
6 99 02 122 00 0	4014586283302	Contact roller Ø63.5 /150	204.00	13	205
6 99 02 123 00 0	4014586283319	Contact roller Ø69.0 /150	186.76	13	205
6 99 02 124 00 0	4014586283326	Contact roller Ø76.1 /150	279.00	13	205
6 99 02 125 00 0	4014586283333	Contact roller Ø76.2 /150	279.00	13	205
6 99 02 126 00 0	4014586283340	Contact roller Ø84.0 /150	256.17	13	205
6 99 02 127 00 0	4014586283357	Contact roller Ø88.9 /150	256.17	13	205
6 99 02 128 00 0	4014586283364	Contact roller Ø101.6 /150	256.17	13	205
6 99 02 129 00 0	4014586283371	Contact roller Ø104.0 /150	350.39	13	205
6 99 02 130 00 0	4014586283388	Contact roller Ø108.0 /150	350.39	13	205
6 99 02 131 00 0	4014586283395	Contact roller Ø114.3 /150	382.00	13	205
6 99 02 132 00 0	4014586283401	Contact roller Ø133.0 /150	773.46	13	205
6 99 02 133 00 0	4014586283418	Contact roller Ø139.7 /150	773.46	13	205
6 99 02 134 00 0	4014586283425	Contact roller Ø168.3 /150	846.20	13	205
6 99 02 136 00 0	4014586284613	Classic	161.40	13	-
6 99 02 155 00 0	4014586284835	Contact roller Ø 152.4 / 150	828.01	13	-
6 99 02 158 00 0	4014586284934	Classic	177.69	13	-
6 99 02 160 00 0	4014586284972	Classic	602.23	13	-
6 99 02 161 00 0	4014586284989	Contact grinding kit for GU150DS/2H	602.23	13	-
6 99 02 162 00 0	4014586284996	Classic	294.33	13	-
6 99 02 163 00 0	4014586285009	Clamping jaws for vice GU	236.01	13	-
6 99 02 165 00 0	4014586285023	Fixing unit for roller support	135.64	13	-
6 99 02 169 00 0	4014586285061	Classic	193.96	13	-
6 99 02 172 00 0	4014586285092	Classic	473.37	13	-
6 99 02 175 00 0	4014586285511	Mitre grinding plate GIG	387.00	13	205
6 99 02 176 00 0	4014586285528	Swivel joint GIT for GIL	320.10	13	207
6 99 02 179 60 0	4014586349381	Pipe support	268.18	13	204
6 99 02 180 00 0	4014586285566	Fittings for angle support	150.56	13	-
6 99 02 180 60 0	4014586351193	Pipe support	475.00	13	204
6 99 02 181 60 0	4014586351209	Pipe support	1,188.00	13	204
6 99 02 182 00 0	4014586285580	Suction socket for GIR	187.00	13	205
6 99 02 183 00 0	4014586285597	Plugbox 2 x 7 poles	141.06	13	207
6 99 02 186 00 0	4014586288499	Connecting piece	90.88	13	204
6 99 02 187 00 0	4014586288482	Connecting piece	114.00	13	204
6 99 02 188 00 0	4014586290683	Contact roller Ø16.0 /150	163.64	13	-
6 99 02 189 00 0	4014586290706	Contact roller Ø18.0 /150	163.64	13	-
6 99 02 190 00 0	4014586290713	Contact roller Ø19.0 /150	163.64	13	-
6 99 02 191 00 0	4014586290720	Contact roller Ø19.1 /150	163.64	13	-
6 99 02 192 00 0	4014586290737	Contact roller Ø21.0 /150	163.64	13	-



Part number	EAN	Description	£ List Price excl. VAT	PC	Page
6 99 02 193 00 0	4014586290744	Contact roller Ø21.3 /150	163.64	13	-
6 99 02 194 00 0	4014586290751	Contact roller Ø22.3 /150	163.64	13	-
6 99 02 195 00 0	4014586290768	Contact roller Ø23.0 /150	163.64	13	-
6 99 02 196 00 0	4014586290775	Contact roller Ø23.2 /150	163.64	13	-
6 99 02 197 00 0	4014586290782	Contact roller Ø24.3 /150	163.64	13	-
6 99 02 198 00 0	4014586290799	Contact roller Ø26.1 /150	163.64	13	-
6 99 02 199 00 0	4014586290805	Contact roller Ø26.7 /150	163.64	13	-
6 99 02 200 00 0	4014586290812	Contact roller Ø27.0 /150	163.64	13	-
6 99 02 201 00 0	4014586290829	Contact roller Ø28.3 /150	163.64	13	-
6 99 02 202 00 0	4014586290836	Contact roller Ø28.6 /150	163.64	13	-
6 99 02 203 00 0	4014586290843	Contact roller Ø29.2 /150	163.64	13	-
6 99 02 204 00 0	4014586290850	Contact roller Ø31.1 /150	163.64	13	-
6 99 02 205 00 0	4014586290867	Contact roller Ø31.5 /150	163.64	13	-
6 99 02 206 00 0	4014586290874	Contact roller Ø31.8 /150	163.64	13	-
6 99 02 207 00 0	4014586290881	Contact roller Ø33.0 /150	163.64	13	-
6 99 02 208 00 0	4014586290898	Contact roller Ø33.4 /150	163.64	13	-
6 99 02 209 00 0	4014586290904	Contact roller Ø34.0 /150	163.64	13	-
6 99 02 210 00 0	4014586290911	Contact roller Ø37.4 /150	163.64	13	-
6 99 02 211 00 0	4014586290928	Contact roller Ø39.8 /150	163.64	13	-
6 99 02 212 00 0	4014586290935	Contact roller Ø40.1 /150	163.64	13	-
6 99 02 213 00 0	4014586290942	Contact roller Ø41.3 /150	163.64	13	-
6 99 02 214 00 0	4014586290959	Contact roller Ø42.0 /150	163.64	13	-
6 99 02 215 00 0	4014586290966	Contact roller Ø42.1 /150	163.64	13	-
6 99 02 216 00 0	4014586290973	Contact roller Ø42.2 /150	163.64	13	-
6 99 02 217 00 0	4014586290980	Contact roller Ø43.0 /150	163.64	13	-
6 99 02 218 00 0	4014586290997	Contact roller Ø45.0 /150	163.64	13	-
6 99 02 219 00 0	4014586291000	Contact roller Ø45.7 /150	163.64	13	-
6 99 02 221 00 0	4014586291024	Contact roller Ø47.4 /150	163.64	13	-
6 99 02 222 00 0	4014586291031	Contact roller Ø48.0 /150	163.64	13	-
6 99 02 223 00 0	4014586291048	Contact roller Ø49.0 /150	163.64	13	-
6 99 02 224 00 0	4014586291055	Contact roller Ø50.1 /150	186.76	13	-
6 99 02 225 00 0	4014586291062	Contact roller Ø51.0 /150	186.76	13	-
6 99 02 226 00 0	4014586291086	Contact roller Ø52.0 /150	186.76	13	-
6 99 02 227 00 0	4014586291093	Contact roller Ø93.2 /150	256.17	13	-
6 99 02 228 00 0	4014586291109	Contact roller Ø107.0 /150	365.72	13	-
6 99 02 229 00 0	4014586291116	Contact roller Ø54.0 /150	186.76	13	-
6 99 02 230 00 0	4014586291123	Contact roller Ø55.0 /150	186.76	13	-
6 99 02 231 00 0	4014586291130	Contact roller Ø57.0 /150	186.76	13	-
6 99 02 232 00 0	4014586291147	Contact roller Ø57.8 /150	186.76	13	-
6 99 02 233 00 0	4014586291154	Contact roller Ø58.0 /150	186.76	13	-
6 99 02 234 00 0	4014586291161	Contact roller Ø59.5 /150	186.76	13	-
6 99 02 235 00 0	4014586291178	Contact roller Ø62.0 /150	186.76	13	-
6 99 02 236 00 0	4014586291185	Contact roller Ø63.0 /150	204.00	13	-
6 99 02 237 00 0	4014586291192	Contact roller Ø64.2 /150	186.76	13	-
6 99 02 238 00 0	4014586291208	Contact roller Ø65.0 /150	186.76	13	-
6 99 02 239 00 0	4014586291215	Contact roller Ø66.0 /150	186.76	13	-
6 99 02 240 00 0	4014586291222	Contact roller Ø66.3 /150	186.76	13	-
6 99 02 241 00 0	4014586291239	Contact roller Ø66.7 /150	186.76	13	-
6 99 02 242 00 0	4014586291246	Contact roller Ø67.1 /150	186.76	13	-
6 99 02 243 00 0	4014586291253	Contact roller Ø69.9 /150	186.76	13	-
6 99 02 244 00 0	4014586291260	Contact roller Ø70.0 /150	186.76	13	-
6 99 02 245 00 0	4014586291277	Contact roller Ø73.0 /150	204.00	13	-
6 99 02 246 00 0	4014586291284	Contact roller Ø73.8 /150	186.76	13	-
6 99 02 247 00 0	4014586291291	Contact roller Ø75.0 /150	186.76	13	-
6 99 02 248 00 0	4014586291307	Contact roller Ø75.1 /150	256.17	13	-
6 99 02 249 00 0	4014586291314	Contact roller Ø76.0 /150	256.17	13	-
6 99 02 250 00 0	4014586291321	Contact roller Ø78.0 /150	256.17	13	-
6 99 02 251 00 0	4014586291338	Contact roller Ø79.4 /150	256.17	13	-
6 99 02 252 00 0	4014586291345	Contact roller Ø79.8 /150	256.17	13	-
6 99 02 253 00 0	4014586291352	Contact roller Ø80.0 /150	256.17	13	-
6 99 02 254 00 0	4014586291369	Contact roller Ø80.2 /150	256.17	13	-
6 99 02 255 00 0	4014586291376	Contact roller Ø81.0 /150	256.17	13	-
6 99 02 256 00 0	4014586291383	Contact roller Ø82.0 /150	256.17	13	-
6 99 02 257 00 0	4014586291390	Contact roller Ø82.1 /150	256.17	13	-
6 99 02 258 00 0	4014586291406	Contact roller Ø82.5 /150	256.17	13	-
6 99 02 259 00 0	4014586291413	Contact roller Ø83.0 /150	256.17	13	-
6 99 02 260 00 0	4014586291420	Contact roller Ø84.1 /150	256.17	13	-
6 99 02 261 00 0	4014586291437	Contact roller Ø85.0 /150	256.17	13	-
6 99 02 262 00 0	4014586291444	Contact roller Ø86.7 /150	256.17	13	-
6 99 02 263 00 0	4014586291451	Contact roller Ø87.0 /150	256.17	13	-
6 99 02 264 00 0	4014586291468	Contact roller Ø88.0 /150	256.17	13	-
6 99 02 265 00 0	4014586291475	Contact roller Ø89.0 /150	256.17	13	-
6 99 02 266 00 0	4014586291482	Contact roller Ø89.3 /150	256.17	13	-
6 99 02 267 00 0	4014586291499	Contact roller Ø89.9 /150	256.17	13	-
6 99 02 268 00 0	4014586291505	Contact roller Ø90.0 /150	256.17	13	-
6 99 02 269 00 0	4014586291512	Contact roller Ø92.0 /150	256.17	13	-
6 99 02 271 00 0	4014586291543	Contact roller Ø100.0 /150	256.17	13	-

Accessories in numerical order

Part number	EAN	Description	£ List Price excl, VAT	PC	Page
6 99 02 272 00 0	4014586291635	Contact roller Ø100.5 /150	256.17	13	-
6 99 02 273 00 0	4014586291642	Contact roller Ø101.0 /150	256.17	13	-
6 99 02 274 00 0	4014586291659	Contact roller Ø101.3 /150	256.17	13	-
6 99 02 275 00 0	4014586291987	Contact roller Ø102.0 /150	256.17	13	-
6 99 02 276 00 0	4014586291994	Contact roller Ø102.5 /150	256.17	13	-
6 99 02 277 00 0	4014586292007	Contact roller Ø102.6 /150	356.72	13	-
6 99 02 278 00 0	4014586292014	Contact roller Ø105.0 /150	356.72	13	-
6 99 02 279 00 0	4014586292021	Contact roller Ø106.7 /150	356.72	13	-
6 99 02 281 00 0	4014586292045	Contact roller Ø110.0 /150	356.72	13	-
6 99 02 282 00 0	4014586292052	Contact roller Ø114.0 /150	356.72	13	-
6 99 02 283 00 0	4014586292069	Contact roller Ø115.0 /150	356.72	13	-
6 99 02 284 00 0	4014586292076	Contact roller Ø117.0 /150	356.72	13	-
6 99 02 285 00 0	4014586292083	Contact roller Ø118.0 /150	356.72	13	-
6 99 02 286 00 0	4014586292090	Contact roller Ø118.2 /150	356.72	13	-
6 99 02 287 00 0	4014586292106	Contact roller Ø120.0 /150	356.72	13	-
6 99 02 288 00 0	4014586292113	Contact roller Ø121.0 /150	356.72	13	-
6 99 02 289 00 0	4014586293080	Contact roller Ø122.0 /150	356.72	13	-
6 99 02 290 00 0	4014586292120	Contact roller Ø124.0 /150	356.72	13	-
6 99 02 291 00 0	4014586292137	Contact roller Ø125.0 /150	356.72	13	-
6 99 02 292 00 0	4014586292144	Contact roller Ø127.0 /150	356.72	13	-
6 99 02 293 00 0	4014586292151	Contact roller Ø127.5 /150	356.72	13	-
6 99 02 294 00 0	4014586292168	Contact roller Ø128.0 /150	356.72	13	-
6 99 02 295 00 0	4014586292175	Contact roller Ø129.0 /150	356.72	13	-
6 99 02 296 00 0	4014586292182	Contact roller Ø130.0 /150	356.72	13	-
6 99 02 297 00 0	4014586292199	Contact roller Ø135.0 /150	789.40	13	-
6 99 02 298 00 0	4014586292205	Contact roller Ø138.0 /150	789.40	13	-
6 99 02 299 00 0	4014586292212	Contact roller Ø139.0 /150	789.40	13	-
6 99 02 300 00 0	4014586292229	Contact roller Ø140.0 /150	816.52	13	-
6 99 02 301 00 0	4014586292236	Contact roller Ø141.3 /150	816.52	13	-
6 99 02 302 00 0	4014586292243	Contact roller Ø141.9 /150	816.52	13	-
6 99 02 303 00 0	4014586292250	Contact roller Ø144.2 /150	816.52	13	-
6 99 02 304 00 0	4014586292267	Contact roller Ø15.0 /150	114.03	13	-
6 99 02 305 00 0	4014586292274	Contact roller Ø150.0 /150	845.01	13	-
6 99 02 306 00 0	4014586292281	Contact roller Ø152.0 /150	845.01	13	-
6 99 02 308 00 0	4014586292304	Contact roller Ø154.0 /150	845.01	13	-
6 99 02 309 00 0	4014586292311	Contact roller Ø159.0 /150	845.01	13	-
6 99 02 310 00 0	4014586292328	Contact roller Ø160.0 /150	862.64	13	-
6 99 02 311 00 0	4014586292335	Contact roller Ø163.0 /150	862.64	13	-
6 99 02 312 00 0	4014586292342	Contact roller Ø165.0 /150	862.64	13	-
6 99 02 313 00 0	4014586292359	Contact roller Ø165.1 /150	862.64	13	-
6 99 02 314 00 0	4014586292366	Contact roller Ø168.0 /150	862.64	13	-
6 99 02 315 00 0	4014586292373	Contact roller Ø172.2 /150	900.63	13	-
6 99 02 316 00 0	4014586292380	Contact roller Ø180.0 /150	569.67	13	-
6 99 02 317 00 0	4014586292397	Contact roller Ø188.4 /150	569.67	13	-
6 99 02 318 00 0	4014586292403	Contact roller Ø190.0 /150	569.67	13	-
6 99 02 319 00 0	4014586292410	Contact roller Ø195.0 /150	569.67	13	-
6 99 02 320 00 0	4014586292427	Contact roller Ø202.0 /150	526.27	13	-
6 99 02 321 00 0	4014586292533	Contact roller Ø215.0 /150	618.50	13	-
6 99 02 322 00 0	4014586292540	Contact roller Ø219.0 /150	618.50	13	-
6 99 02 323 00 0	4014586292557	Contact roller Ø31.0 /150	114.03	13	-
6 99 02 324 00 0	4014586292564	Contact roller Ø57.5 /150	140.48	13	-
6 99 02 326 00 0	4014586292588	Contact roller Ø68.0	140.48	13	-
6 99 02 327 00 0	4014586292595	Contact roller Ø84.0 /150	160.31	13	-
6 99 02 328 00 0	4014586295251	Guide arms, complete	858.58	13	-
6 99 02 332 00 0	4014586295435	Contact roller Ø68.9 /150	186.76	13	-
6 99 02 333 00 0	4014586295718	Nylon roller support	488.29	13	-
6 99 02 335 00 0	4014586296609	Jawset vice	305.19	13	207
6 99 02 338 00 0	4014586299488	Stainless steel sanding support	171.35	13	203
6 99 02 343 00 0	4014586349398	Spark box with dust extraction	122.00	13	203
6 99 02 344 00 0	4014586349404	Stainless steel sanding support	59.59	13	204
6 99 02 345 00 0	4014586378589	Contact wheel D200 x 30, Shore 90	420.00	13	-
6 99 02 346 00 0	4014586379296	Contact disc	358.00	13	207
6 99 02 410 00 0	4014586299310	Drive wheel puller	88.92	06	207
6 99 03 000 00 0	4014586278483	Grinding belt 75 x 2000 K24 R 10 each	168.83	12	201
6 99 03 002 00 0	4014586278506	Grinding belt 75 x 2000 K36 R 10 each	137.62	12	201
6 99 03 003 00 0	4014586278513	Grinding belt 75 x 2000 K36 Z 10 each	104.44	12	202
6 99 03 004 00 0	4014586278520	Grinding belt 75 x 2000 K40 R 10 each	125.72	12	201
6 99 03 005 00 0	4014586278537	Grinding belt 75 x 2000 K40 Z 10 each	99.18	12	202
6 99 03 007 00 0	4014586278551	Grinding belt 75 x 2000 K60 R 10 each	115.62	12	201
6 99 03 008 00 0	4014586278568	Grinding belt 75 x 2000 K60 Z 10 each	87.81	12	202
6 99 03 009 00 0	4014586278575	Grinding belt 75 x 2000 K80 R 10 each	108.64	12	201
6 99 03 010 00 0	4014586278582	Grinding belt 75 x 2000 K80 Z 10 each	82.52	12	202
6 99 03 013 00 0	4014586278612	Grinding belt 75 x 2000 K120 R 10 each	103.27	12	201
6 99 03 014 00 0	4014586278629	Grinding belt 75 x 2000 K120 Z 10 each	78.34	12	202
6 99 03 017 00 0	4014586278650	Grinding belt 75 x 2000 K220 A 10 each	76.32	12	202
6 99 03 018 00 0	4014586278667	Grinding belt 75 x 2000 K320 A 10 each	76.32	12	202
6 99 03 019 00 0	4014586278674	Grinding belt 75 x 2000 K400 A 10 each	73.38	12	202





Part number	EAN	Description	£ List Price excl. VAT	PC	Page
6 99 03 020 00 0	4014586278681	Grinding belt 75 x 2250 K36 R 10 each	154.11	12	201
6 99 03 021 00 0	4014586278698	Grinding belt 75 x 2250 K36 Z 10 each	116.94	12	202
6 99 03 034 00 0	4014586283616	Grinding belt 100 x 1000 K36 Z 10 each	73.20	12	202
6 99 03 035 00 0	4014586283623	Grinding belt 100 x 1000 K40 Z 10 each	69.64	12	202
6 99 03 036 00 0	4014586283630	Grinding belt 100 x 1000 K60 Z 10 each	59.20	12	202
6 99 03 037 00 0	4014586283647	Grinding belt 100 x 1000 K 80 Z 10 each	57.95	12	202
6 99 03 038 00 0	4014586283654	Grinding belt 100 x 1000 K120 Z 10 each	53.00	12	202
6 99 03 039 00 0	4014586283661	Grinding belt 150 x 2000 K24 R 10 each	288.82	12	201
6 99 03 040 00 0	4014586283678	Grinding belt 150 x 2000 K36 R 10 each	239.66	12	201
6 99 03 041 00 0	4014586283685	Grinding belt 150 x 2000 K36 Z 10 each	194.57	12	202
6 99 03 042 00 0	4014586283692	Grinding belt 150 x 2000 K40 R 10 each	236.64	12	201
6 99 03 043 00 0	4014586283708	Grinding belt 150 x 2000 K40 Z 10 each	184.96	12	202
6 99 03 044 00 0	4014586283715	Grinding belt 150 x 2000 K60 R 10 each	209.20	12	201
6 99 03 045 00 0	4014586283722	Grinding belt 150 x 2000 K60 Z 10 each	163.76	12	202
6 99 03 046 00 0	4014586283739	Grinding belt 150 x 2000 K80 R 10 each	196.75	12	201
6 99 03 047 00 0	4014586283746	Grinding belt 150 x 2000 K80 Z 10 each	153.92	12	202
6 99 03 048 00 0	4014586283753	Grinding belt 150 x 2000 K120 R 10 each	179.68	12	201
6 99 03 049 00 0	4014586283760	Grinding belt 150 x 2000 K120 Z 10 each	140.38	12	202
6 99 03 050 00 0	4014586283777	Grinding belt 150 x 2000 K220 A 10 each	138.96	12	202
6 99 03 051 00 0	4014586283784	Grinding belt 150 x 2000 K320 A 10 each	144.47	12	202
6 99 03 052 00 0	4014586283791	Grinding belt 150 x 2000 K400 A 10 each	144.47	12	202
6 99 03 053 00 0	4014586283807	Grinding belt 150 x 2250 K36 R 10 each	298.83	12	201
6 99 03 054 00 0	4014586283814	Grinding belt 150 x 2250 K36 Z 10 each	233.77	12	202
6 99 03 097 00 0	4014586292915	Grinding belt 100 x 1000 G36 R 10 each	90.18	12	-
6 99 03 098 00 0	4014586292922	Grinding belt 100 x 1000 G60 R 10 each	79.25	12	-
6 99 03 099 00 0	4014586292939	Grinding belt 100 x 1000 G80 R 10 each	74.66	12	-
6 99 03 111 00 0	4014586299235	Grinding belt 150 x 2400 K36 R 10 each	306.70	12	201
6 99 03 112 00 0	4014586299242	Grinding belt 150 x 2400 K36 Z 10 each	239.85	12	202
6 99 03 116 01 0	4014586329888	Fleece belt 150 x 2000 Coarse	424.92	12	202
6 99 03 117 01 0	4014586329895	Fleece belt 75 x 2000 Coarse	212.50	12	202
6 99 03 118 01 0	4014586329901	Fleece belt 150 x 2000 Medium	424.92	12	202
6 99 03 119 01 0	4014586329918	Fleece belt 75 x 2000 Medium	212.50	12	202
6 99 03 120 01 0	4014586329925	Fleece belt 150 x 2000 Very Fine	424.92	12	202
6 99 03 121 01 0	4014586329932	Fleece belt 75 x 2000 Very Fine	204.40	12	202
6 99 03 122 00 0	4014586368054	Abrasive belt	148.42	12	201
6 99 03 122 01 0	4014586332369	Fleece belt set 75	110.25	12	-
6 99 03 126 00 0	4014586379029	Grinding belt Cubitron II 50 x 1000 K36 VE10	183.52	12	186
6 99 03 127 00 0	4014586379036	Grinding belt Cubitron II 50 x 1000 K60 VE10	161.25	12	186
6 99 03 128 00 0	4014586379043	Grinding belt Cubitron II 50 x 1000 K80 VE10	141.56	12	186
6 99 03 130 00 0	4014586379050	Grinding belt 50 x 1000 K36 Z 10 each	69.51	12	187
6 99 03 131 00 0	4014586379067	Grinding belt 50 x 1000 G60 Z 10 each	47.18	12	187
6 99 03 132 00 0	4014586379074	Grinding belt 50 x 1000 G80 Z 10 each	43.25	12	187
6 99 03 133 00 0	4014586379081	Grinding belt 50 x 1000 G120 Z 10 each	35.40	12	187
6 99 03 134 00 0	4014586379098	Grinding belt 50 x 1000 G220 A 10 each	34.06	12	187
6 99 03 135 00 0	4014586379104	Grinding belt 50 x 1000 G320 A 10 each	35.49	12	187
6 99 03 136 00 0	4014586379111	Grinding belt 50 x 1000 G420 A 10 each	35.49	12	187
6 99 03 137 00 0	4014586379128	Grinding belt 50 x 1000 K36 R 10 each	76.04	12	187
6 99 03 138 00 0	4014586379135	Grinding belt 50 x 1000 K60 R 10 each	57.69	12	187
6 99 03 139 00 0	4014586379142	Grinding belt 50 x 1000 K80 R 10 each	52.43	12	187
6 99 03 140 00 0	4014586379159	Grinding belt 50 x 1000 K120 R 10 each	51.13	12	187
6 99 03 142 00 0	4014586379166	Fleece belt 50 x 1000 Coarse	66.84	12	187
6 99 03 143 00 0	4014586379173	Fleece belt 50 x 1000 Medium	64.21	12	187
6 99 03 144 00 0	4014586379180	Fleece belt 50 x 1000 Very Fine	60.30	12	187
6 99 03 145 00 0	4014586385891	Cubitron II 75 x 2000 36+ 10 p grinding belt	265.76	12	201
6 99 03 146 00 0	4014586385907	Cubitron II 75 x 2000 60+ 10 p grinding belt	225.63	12	201
6 99 03 147 00 0	4014586385914	Cubitron II 75 x 2000 80+ 10 p grinding belt	240.86	12	201
6 99 03 148 00 0	4014586385921	Cubitron II 150 x 2000 36+ 10p grinding belt	555.33	12	201
6 99 03 149 00 0	4014586385938	Cubitron II 150 x 2000 60+ 10p grinding belt	462.99	12	201
6 99 03 150 00 0	4014586385945	Cubitron II 150 x 2000 80+ 10p grinding belt	434.90	12	201
6 99 03 151 00 0	4014586385952	Cubitron II 75 x 2250 36+ 10 p grinding belt	346.57	12	201
6 99 03 152 00 0	4014586385969	Cubitron II 75 x 2250 60+ 10 p grinding belt	295.73	12	201
6 99 03 153 00 0	4014586385976	Cubitron II 75 x 2250 80+ 10 p grinding belt	281.00	12	201
6 99 03 154 00 0	4014586385983	Cubitron II 150 x 2250 36+ 10p grinding belt	640.95	12	201
6 99 03 155 00 0	4014586385990	Cubitron II 150 x 2250 60+ 10p grinding belt	536.59	12	201
6 99 03 156 00 0	4014586386003	Cubitron II 150 x 2250 80+ 10p grinding belt	504.47	12	201
6 99 03 157 00 0	4014586405063	Grinding belt Cubitron II 50 x 1150 K36 VE10	193.98	12	186
6 99 03 158 00 0	4014586405070	Grinding belt 50 x 1150 K36 R 10 each	80.37	12	187
6 99 03 159 00 0	4014586405087	Grinding belt 50 x 1150 K36 Z 10 each	73.43	12	187
9 01 04 009 01 0	4014586871622	M55 X magazine	263.00	01	41
9 01 04 010 01 0	4014586871639	M55 X magazine extension with belt guide	228.49	02	41
9 01 05 002 01 8	4014586833682	Safety slipping clutch	1,034.13	02	9
9 06 04 008 01 3	4014586849805	Suction hood	256.40	02	55
9 06 04 009 01 7	4014586849829	Suction hood	269.34	02	55
9 06 06 002 00 9	4014586834467	Saw blade guide	303.80	02	92
9 07 01 002 01 0	4014586878522	Prism vice	116.83	02	14
9 07 02 001 00 1	4014586834498	Clamping fixture	269.35	02	-
9 07 02 003 00 8	4014586834511	Clamping fixture	302.53	02	92

Accessories in numerical order

Part number	EAN	Description	£ List Price excl, VAT	PC	Page
9 07 02 004 00 6	4014586834528	Clamping fixture	375.28	02	92
9 07 02 005 00 0	4014586839783	FEIN clamp and feed device	2,147.03	02	92
9 26 01 022 01 3	4014586846965	Vacuum pump assy	571.86	02	107
9 26 02 030 01 4	4014586836805	Traction cable	17.36	04	181
9 26 02 054 01 6	4014586841342	Suction plate	523.63	02	107
9 26 02 055 01 0	4014586841335	Pipe drilling device	291.04	02	107
9 26 02 057 01 7	4014586843322	Vacuum plate assy	544.10	02	107
9 26 02 063 02 3	4014586844503	Dust Extraction	55.94	04	-
9 26 02 066 01 2	4014586846989	Tapping Unit	1,553.00	01	119
9 26 02 071 01 9	4014586851389	Profile set 160	465.00	01	82
9 26 02 072 01 2	4014586852478	Tapping Unit	1,151.00	01	119
9 26 02 074 01 4	4014586855080	Dust extraction device FSC	55.09	04	175
9 26 02 075 01 8	4014586855097	Device for dust extract	70.41	04	175
9 26 02 079 01 0	4014586857152	Tapping quick-change chuck	293.55	02	119
9 26 02 081 01 0	4014586860183	Dust Extraction	53.48	04	-
9 26 02 082 01 0	4014586861920	Tapping quick-change chuck	407.20	02	123
9 26 02 083 01 0	4014586860152	Table-top and drill jigs support	49.75	04	168
9 26 02 084 01 0	4014586863542	Device for dust extract	71.70	04	175
9 26 02 085 01 0	4014586867977	Vacuum plate	539.97	02	123
9 26 02 088 01 0	4014586878492	Dust extraction set	43.51	04	-
9 26 02 089 01 0	4014586878508	Tappingfast-rel.chuck	293.58	02	119
9 26 02 091 00 0	4014586882932	Dust extraction set FMM 350 Q / QSL	44.49	04	168
9 26 02 092 00 0	4014586882949	Dust extraction set FMT / FMM 250	55.88	04	168
9 26 02 095 00 0	4014586885551	Dust extraction set	53.04	04	169
9 26 04 079 02 1	4014586853574	Battery ass.	196.47	02	-
9 26 04 082 02 5	4014586855127	NiMH battery 9.6 V	154.55	02	-
9 26 04 084 02 7	4014586855141	NiMH battery 12 V / 2000 mAh	166.01	02	-
9 26 04 096 01 0	4014586863986	Quick charger ALG 30	163.10	02	-
9 26 04 096 03 0	4014586887128	Quick charger ALG 30	3,480.13	02	35
9 26 04 097 01 0	4014586863993	Quick charger ALG 30	163.10	02	11
9 26 04 103 01 0	4014586862651	Charging adapter	17.07	02	35
9 26 04 111 01 0	4014586869308	Multi-charger ALS 40	1,681.44	02	35
9 26 04 129 01 0	4014586867687	Quick charger ALG 50	45.53	02	11
9 26 04 160 00 0	4014586871561	Contact holder	66.09	02	-
9 26 04 160 03 0	4014586877228	Battery Li-Ion 14,4V	1,123.51	02	-
9 26 04 161 02 0	4014586872803	Li-Ion battery, 18V	118.28	02	-
9 26 04 161 03 0	4014586880334	Li-Ion battery, 18V	1,206.12	02	-
9 26 04 163 02 0	4014586872681	Programming adapter	452.83	02	36
9 26 04 164 03 0	4014586877235	Battery Li-Ion 14,4V	1,612.09	02	-
9 26 04 168 02 0	4014586881157	Li-Ion battery, 12V	31.90	02	168
9 26 04 170 02 0	4014586882727	Battery Li-Ion 14,4V	107.77	02	35
9 26 04 170 03 0	4014586885148	Battery Li-Ion 14,4V	1,120.72	02	35
9 26 04 171 02 0	4014586882734	Li-Ion battery, 18V	76.34	02	11
9 26 04 171 03 0	4014586885155	Li-Ion battery, 18V	895.89	02	35
9 26 04 172 02 0	4014586882741	Battery Li-Ion 14,4V	146.42	02	35
9 26 04 172 03 0	4014586885162	Battery Li-Ion 14,4V	1,608.13	02	35
9 26 04 173 02 0	4014586882758	Li-Ion battery, 18V	111.38	02	11
9 26 04 173 03 0	4014586885179	Li-Ion battery, 18V	1,285.53	02	35
9 26 04 179 02 0	4014586888224	HighPower battery pack	117.78	02	120
9 26 04 200 02 0	4014586882819	Cordless ALED 12-18 V LED lamp	56.59	02	120
9 26 04 250 01 0	4014586885827	Battery starter set 12 V / 2,5 Ah	114.30	02	-
9 26 04 251 01 0	4014586885834	Battery starter set 12 V / 2,5 Ah	109.32	02	169
9 26 04 300 03 0	4014586885841	Battery starter set 18 V / 5.0 Ah	279.08	02	-
9 26 04 300 04 0	4014586885858	Battery starter set 18 V / 2,5 Ah	208.30	02	-
9 26 04 301 03 0	4014586885865	Battery starter set 18 V / 5.0 Ah	268.29	02	11
9 26 04 301 04 0	4014586885872	Battery starter set 18 V / 2,5 Ah	197.14	02	11
9 26 04 307 01 0	4014586888972	HighPower battery starter set	281.40	02	120



Part number	Sound pressure level LpA (dB)	Uncertainty of measured value KpA (dB)	Sound power level LWA (dB)	Uncertainty of measured value KWA (dB)	Sound peak value LpCpeak (dB)	Uncertainty of measured value KpC (dB)	Vibration value 1 ahv 3-way (m/s <sup>2</sup> )	Vibration value 2 ahv 3-way (m/s <sup>2</sup> )	Uncertainty of measured value Ka (m/s <sup>2</sup> )
7 205 43	82	3	93	3	96	3	4	1,5	
7 205 44	82	3	93	3	96	3	3	1,5	
7 205 45	82	3	93	3	96	3	3	1,5	
7 201 39	77	3	88	3		3	1,3	1,5	
7 201 63	77	3	88	3		3	1,4	1,5	
7 201 62	77	3	88	3		3	1,2	1,5	
7 205 35	77	3	88	3		3	1,2	1,5	
7 201 06	86	3	97	3	102	3	ah,D 2,0	1,5	
7 201 14	86	3	97	3	102	3	ah,D 2,0	1,5	
7 205 20	76	3	87	3		3	< 2,5	1,5	
7 205 03	81	3	92	3	98	3	ah,D 0,4	1,5	
7 202 45	78	3	89	3		3	1,6	1,5	
7 205 37	75	3	86	3		3	1,2	1,5	
7 205 40	84	3	95	3	99	3	1,5	1,5	
7 202 03	86	3	97	3	102	3	ah,D 2,2	1,5	
7 202 10	86	3	97	3	102	3	ah,D 2,2	1,5	
7 202 26	81	3	92	3	97	3	ah,D 0,6	1,5	
7 202 27	81	3	92	3	97	3	ah,D 0,6	1,5	
7 202 09	86	3	97	3	102	3	ah,D 1,6	1,5	
7 202 06	88	3	99	3	103	3	ah,D 1,3	1,5	
7 205 01	81	3	92	3	99	3	ah,D 0,9	1,5	
7 205 34	77	3	88	3	93	3	1,1	1,5	
7 203 04	86	3	97	3	102	3	ah,D 1,5	1,5	
7 204 30	98	3	109	3	99	3	1,5	1,5	15
7 209 37	79	3	90	3	93	3	0,6	1,5	
7 209 16	87	3	98	3	101	3	1	1,5	
7 271 01	81	3	92	3	96	3	ah,D 3,5	1,5	ah,D 5,0
7 272 02	87	3	98	3	103	3		1,5	
7 272 03	87	3	98	3	99	3		1,5	
7 272 04	92	3	103	3	106	3		1,5	
7 270 27	84	3	95	3		3	0,5	1,5	
7 270 33	84	3	95	3		3		1,5	
7 270 31	82	3	93	3		3		1,5	
7 270 29	83	3	94	3		3		1,5	
7 270 28	83	3	94	3		3		1,5	
7 270 34	84	3	95	3	101	3		1,5	
7 270 32	84	3	95	3	101	3		1,5	
7 113 01	60	3	71	3	74	3	0,9	1,5	
7 113 02	71	3	82	3	84	3	1,2	1,5	
7 113 03	71	3	82	3	84	3	1,3	1,5	
7 113 06	71	3	82	3	84	3	1,6	1,5	
7 104 03	86	3	97	3	104	3	14	1,5	
7 104 04	90	3	101	3	105	3	12	1,5	
7 210 71	78	3	89	3	92	3	1,1	1,5	
7 210 94	78	3	89	3	92	3	1	1,5	
7 113 10	71	3	82	3	88	3	0,7	1,5	
7 113 11	73	3	84	3	92	3	1	1,5	
7 213 09	77	3	88	3	93	3	0,5	1,5	
7 213 04	82	3	93	3	96	3	1	1,5	
7 213 13	81	3	92	3	98	3	0,8	1,5	
7 213 14	81	3	92	3	98	3	0,8	1,5	
7 213 06	81	3	92	3	98	3	0,8	1,5	
7 213 08	81	3	92	3	98	3	0,8	1,5	
7 213 15	81	3	92	3	98	3	0,8	1,5	
7 210 98	86	3	97	3		3	<2,5	1,5	
7 215 29	93	3	104	3		3	6,5	1,5	
7 215 30	93	3	104	3		3	6,5	1,5	
7 215 28	96	3	107	3		3	8,8	1,5	
7 215 12	93	3	104	3		3	5,4	1,5	
7 215 13	93	3	104	3		3	5,4	1,5	
7 215 23	93	3	104	3		3	5,4	1,5	
7 215 07	95	3	106	3		3	10	1,5	
7 215 08	95	3	106	3		3	10	1,5	
7 215 21	95	3	106	3		3	10	1,5	
7 215 25	95	3	106	3		3	10	1,5	
7 215 26	95	3	106	3		3	10	1,5	
7 112 07	69	3	80	3		3	0,2	1,5	
7 112 06	62	3	73	3		3	0,2	1,5	
7 112 05	60	3	71	3		3	0,2	1,5	
7 112 04	67	3	78	3		3	0,3	1,5	

Vibration and noise emission values

Part number	Sound pressure level LpA (dB)	Uncertainty of measured value KpA (dB)	Sound power level LWA (dB)	Uncertainty of measured value KWA (dB)	Sound peak value LpCpeak (dB)	Uncertainty of measured value KpC (dB)	Vibration value 1 ahv 3-way (m/s <sup>2</sup> )	Vibration value 2 ahv 3-way (m/s <sup>2</sup> )	Uncertainty of measured value Ka (m/s <sup>2</sup> )
7 112 03	65	3	76	3		3	0,4	1,5	
7 112 36	69	3	80	3		3	0,4	1,5	
7 112 40	62	3	73	3	79,7	3	0,4	1,5	
7 112 41	62	3	73	3	79,7	3	0,4	1,5	
7 112 42	60	3	71	3	75,6	3	0,4	1,5	
7 112 43	60	3	71	3	75,6	3	0,4	1,5	
7 112 44	60	3	71	3	75,6	3	0,4	1,5	
7 112 02	69	3	80	3		3	0,5	1,5	
7 112 01	68	3	79	3		3	0,6	1,5	
7 113 05	70	3	81	3		3	<2,5	1,5	
7 110 94	70	3	81	3		3	<2,5	1,5	
7 112 45	64,6	3	75,6	3	81,1	3	0,6	1,5	
7 221 61	84	3	95	3	99	3	ah,AG 5,0	1,5	ah,DS 2,5
7 221 62	84	3	95	3	99	3	ah,AG 4,5	1,5	ah,DS 2,5
7 221 41	87	3	98	3	99	3	ah,AG 5,0	1,5	ah,DS 2,5
7 221 44	84	3	95	3	99	3	ah,AG 4,5	1,5	ah,DS 2,5
7 221 42	84	3	95	3	101	3	ah,AG 4,5	1,5	ah,DS 2,5
7 221 43	84	3	95	3	101	3	ah,AG 4,5	1,5	ah,DS 2,5
7 221 40	87	3	98	3	99	3	ah,AG 5,0	1,5	ah,DS 2,5
7 221 46	85	3	96	3		3	ah,AG 4,5	1,5	
7 221 47	85	3	96	3		3	ah,AG 5,0	1,5	
7 221 31	87	3	98	3		3	ah,AG 3,8	1,5	
7 221 07	87	3	98	3	103	3	ah,AG 6,0	1,5	ah,DS 2,5
7 221 08	87	3	98	3	103	3	ah,AG 6,0	1,5	ah,DS 2,5
7 221 05	87	3	98	3	103	3	ah,AG 6,0	1,5	ah,DS 2,5
7 221 06	87	3	98	3	103	3	ah,AG 6,0	1,5	ah,DS 2,5
7 221 26	87	3	98	3	103	3	ah,AG 6,0	1,5	ah,DS 2,5
7 221 27	87	3	98	3	103	3	ah,AG 6,0	1,5	ah,DS 2,5
7 221 01	87	3	98	3	103	3	ah,AG 6,0	1,5	ah,DS 2,5
7 221 02	87	3	98	3	103	3	ah,AG 6,0	1,5	ah,DS 2,5
7 223 02	81	3	92	3	95	3	ah,SG 1,5	1,5	
7 223 12	84	3	95	3	98	3	ah,SG 1,6	1,5	
7 223 03	81	3	92	3	95	3	ah,SG 1,5	1,5	
7 223 14	87	3	98	3	101	3	ah,SG ØD=50 mm 17,0	1,5	ah,SG ØD=12 mm 2,3
7 223 14	86	3	97	3	101	3	ah,SG ØD=50 mm 27,0	1,5	ah,SG ØD=12 mm 3,9
7 223 13	86	3	97	3	100	3	ah,SG ØD=50 mm 2,9	1,5	ah,SG ØD=12 mm 1,5
7 224 04	87	3	98	3	103	3	ah,SG 2,4	1,5	
7 224 05	93	3	104	3	106	3	ah,SG 2,0	1,5	
7 220 78	87	3	98	3	105	3	12	1,5	
7 220 92	87	3	98	3		3	4	1,5	
7 221 63	84	3	95	3	100	3	ah,P 3,5	1,5	ah,DS 2,5
7 221 48	84	3	95	3	100	3	ah,P 2,5	1,5	ah,DS 2,5
7 221 49	84	3	95	3	100	3	ah,P 3,5	1,5	ah,DS 2,5
7 221 50	84	3	95	3	100	3	ah,P 2,5	1,5	
7 221 66	84	3	95	3	98	3	4,5	1,5	
7 221 13	86	3	97	3	102	3	2,4	1,5	
7 228 05	84	3	95	3	99	3	2	1,5	
7 221 67	85	3	96	3	101	3	ah,P/T=3 2,5	1,5	ah,P/T=6 5,0
7 129 09	76	3	87	3	91	3		1,5	
7 536 02	81	3	92	3		3		1,5	
7 229 36	74	3	85	3	96	3		1,5	
7 229 37	74	3	85	3	96	3		1,5	
7 136 01	78	3	89	3	91	3		1,5	
7 136 02	78	3	89	3	91	3		1,5	
7 236 36	79	3	90	3	93	3		1,5	
7 236 31	79	3	90	3	93	3		1,5	
7 230 27	82	3	93	3		3	1,5	1,5	
7 230 28	82	3	93	3		3	1,5	1,5	
7 230 22	81	3	92	3		3	1,5	1,5	
7 230 29	80	3	91	3		3	4,7	1,5	
7 230 26	80	3	91	3		3	15,6	1,5	
7 230 23	86	3	97	3	103	3	12,1	1,5	
7 230 24	87	3	98	3	103,1	3	22,6	1,5	
7 232 35	76	3	87	3	92	3	11,3	1,5	
7 232 32	76	3	87	3	92	3	9,3	1,5	
7 232 36	76	3	87	3	92	3	6,4	1,5	
7 232 37	77	3	88	3	93	3	9,19	1,5	
7 232 29	78	3	89	3	93	3	4,4	1,5	
7 232 30	85	3	96	3	100	3	8,9	1,5	
7 232 31	85	3	96	3	100	3	10	1,5	



Part number	Sound pressure level LpA (dB)	Uncertainty of measured value KpA (dB)	Sound power level LWA (dB)	Uncertainty of measured value KWA (dB)	Sound peak value LpCpeak (dB)	Uncertainty of measured value KpC (dB)	Vibration value 1 ahv 3-way (m/s <sup>2</sup> )	Vibration value 2 ahv 3-way (m/s <sup>2</sup> )	Uncertainty of measured value Ka (m/s <sup>2</sup> )
7 234 17	79	3	90	3	94	3	7,8	1,5	
7 234 15	79	3	90	3	94	3	7,8	1,5	
7 234 06	83	3	94	3	97	3	16	1,5	13
7 234 22	89	3	100	3	102	3	7	1,5	
7 234 23	89	3	100	3	102	3	7	1,5	
7 534 08	81	3	92	3	102	3	ah,D 7.1	1,5	
7 238 14	86,5	3	97,5	3	102	3	3,5	1,5	
7 824 41	84	3	95	3	97	3	Ø 80 mm=11,8 Ø 50 mm=6,3	1,5	
7 824 39	84	3	95	3	103	3	Ø 125 mm=7,5	1,5	
7 824 40	84	3	95	3	97	3	Ø 100 mm=3,3	1,5	
7 824 37	83	3	94	3	101	3	Ø 125 mm=2,0	1,5	
7 824 36	79	3	90	3	98	3	2	1,5	
7 824 38	83	3	94	3	101	3	3,8	1,5	
7 823 03	71	3	82	3	85	3	3,7	1,5	
7 823 14	77	3	88	3	88	3	3,7	1,5	
7 823 15	71	3	82	3	84	3	2	1,5	
7 823 19	79	3	90	3	92	3	5	1,5	
7 823 21	79	3	90	3		3	1	1,5	
7 823 20	77	3	88	3	92	3	5,5	1,5	
7 820 51	77	3	88	3	93	3	3,5	1,5	
7 820 81	76	3	87	3	91	3	0,5	1,5	
7 820 84	81	3	92	3	98	3	2,1	1,5	
7 820 85	81	3	92	3	95	3	4,5	1,5	
7 820 78	79	3	90	3	95	3	0,6	1,5	
7 820 79	81	3	92	3	100	3	4,3	1,5	
7 820 71	81	3	92	3	95	3	4,3	1,5	
7 820 72	81	3	92	3	95	3	4,6	1,5	
7 820 83	83	3	94	3	97	3	3,6	1,5	
7 820 62	83	3	94	3	100	3	3,9	1,5	
7 820 64	84	3	95	3	100	3	3,9	1,5	
7 820 74	85	3	96	3	100	3	3,8	1,5	
7 820 76	85	3	96	3	100	3	4,7	1,5	
7 105 01	75	3	86	3	91	3	2,7	1,5	
7 105 02	75	3	86	3	89	3	1,8	1,5	
7 105 03	75	3	86	3	91	3	2,5	1,5	
7 205 46	82	3	93	3	96	3	3	1,5	
7 272 01	83	3	94	3	98	3		1,5	
7 113 14	71	3	82	3	86	3	1,5	1,5	
7 113 14	71	3	82	3	86	3	1,5	1,5	
7 113 15	71	3	82	3	86	3	1,5	1,5	
7 113 15	71	3	82	3	86	3	1,5	1,5	
7 113 16	74	3	85	3	87	3	1,5	1,5	
7 113 16	74	3	85	3	87	3	1,5	1,5	
7 113 17	74	3	85	3	87	3	1,5	1,5	
7 113 17	74	3	85	3	87	3	1,5	1,5	
7 221 55	85	3	96	3	99	3	ah,AG 4,5	1,5	ah,DS 2,0
7 221 56	85	3	96	3	99	3	ah,AG 4,5	1,5	ah,DS 2,5
7 221 57	85	3	96	3	101	3	ah,AG 4,0	1,5	ah,DS 2,5
7 221 58	85	3	96	3	101	3	ah,AG 4,0	1,5	ah,DS 2,5
7 221 54	85	3	96	3	99	3	ah,AG 4,5	1,5	ah,DS 2,5
7 236 42	79	3	90	3	93	3		1,5	
7 820 86	74	3	85	3	90	3	ah,AG 2,8	1,5	ah,DS 1,0
7 536 03	82	3	93	3		3		1,5	
7 132 03	74	3	85	3	86	3	4,7	1,5	
7 132 02	74	3	85	3	86	3	4,7	1,5	
7 132 01	74	3	85	3	86	3	6,5	1,5	
7 144 01	67	3	78	3	83	3		1,5	
7 232 38	82	3	93	3	93	3	8,8	1,5	
7 232 41	82	3	93	3	93	3	9,5	1,5	
7 232 42	82	3	93	3	93	3	6,8	1,5	
7 232 39	82	3	93	3	93	3	8,8	1,5	
7 232 40	80	3	91	3	91	3	7,3	1,5	
7 520 15	80	3	91	3		3	4,5	1,5	
7 520 16	80	3	91	3		3	4,5	1,5	
9 20 22	73	3	84	3		3		1,5	
9 20 23	73	3	84	3		3		1,5	
7 270 41	82,4	3	93,4	3	97	3	< 2,5	1,5	
7 270 40	82,4	3	93,4	3	97	3	< 2,5	1,5	
7 270 42	82,4	3	93,4	3	97	3	< 2,5	1,5	

**Vibration and noise emission values**

Part number	Sound pressure level LpA (dB)	Uncertainty of measured value KpA (dB)	Sound power level LWA (dB)	Uncertainty of measured value KWA (dB)	Sound peak value LpCpeak (dB)	Uncertainty of measured value KpC (dB)	Vibration value 1 ahv 3-way (m/s <sup>2</sup> )	Vibration value 2 ahv 3-way (m/s <sup>2</sup> )	Uncertainty of measured value Ka (m/s <sup>2</sup> )
7 270 43	82,4	3	93,4	3	97	3	< 2,5	1,5	
7 113 18	80	3	91	3	91	3	0,5	1,5	1,5
7 113 18	80	3	91	3	91	3	0,5	1,5	1,5
7 104 05	85	3	96	3	104	3	0,5	1,5	10,5
7 104 05	85	3	96	3	104	3	0,5	1,5	10,5
7 113 19	76	3	87	3	90	3	0,6	1,5	1,8
7 113 19	76	3	87	3	90	3	0,6	1,5	1,8
7 104 06	87	3	98	3	106	3	0,6	1,5	12,1
7 104 06	87	3	98	3	106	3	0,6	1,5	12,1
7 115 01	86	3	97	3	109	3	6	1,5	
7 115 01	86	3	97	3	109	3	6	1,5	
7 115 02	86	3	97	3	109	3	6	1,5	
7 115 02	86	3	97	3	109	3	6	1,5	
7 116 01	74	3	85	3	87	3	1,5	1,5	
7 116 02	74	3	85	3	87	3	1,5	1,5	
7 116 06	74	3	85	3	87	3	1,5	1,5	
7 116 05	74	3	85	3	87	3	1,5	1,5	
7 116 03	73	3	84	3	86	3	1,5	1,5	
7 116 04	73	3	84	3	86	3	1,5	1,5	
7 116 04	73	3	84	3	86	3	1,5	1,5	
7 116 08	73	3	84	3	86	3	1,5	1,5	
7130 02	74,6	3	85,6	3	87,9	3	3,3	1,5	
7 130 01	74,8	3	85,8	3	87,9	3	10,1	1,5	
7 230 34	82,5	3	93,5	3	94,9	3	4,1	1,5	
7 230 35	81,7	3	92,7	3	93,8	3	4,8	1,5	
7 230 31	81,1	3	92,1	3	93,3	3	5,7	1,5	
7 230 32	81,1	3	92,1	3	93,3	3	5,7	1,5	
7 230 33	76,2	3	87,2	3	91	3	10,8	1,5	
7 221 73	90	3	101	3	105	3	ah,AG 5,0	1,5	ah,DS 1,8
7 221 74	90	3	101	3	105	3	ah,AG 5,0	1,5	ah,DS 1,8
7 221 77	90	3	101	3	105	3	ah,AG 6,0	1,5	ah,DS 1,8
7 221 75	89	3	100	3	104	3	ah,AG 5,0	1,5	ah,DS 2,0
7 221 76	89	3	100	3	104	3	ah,AG 5,0	1,5	ah,DS 2,0
7 221 78	90	3	101	3	105	3	ah,AG 5,0	1,5	ah,DS 3,5
7 221 79	90	3	101	3	105	3	ah,AG 5,0	1,5	ah,DS 3,5
7 221 80	90	3	101	3	105	3	ah,AG 5,0	1,5	ah,DS 3,5
7 221 81	90	3	101	3	105	3	ah,AG 5,0	1,5	ah,DS 3,5
7 221 82	90	3	101	3	105	3	ah,AG 5,0	1,5	ah,DS 3,5
7 221 83	90	3	101	3	105	3	ah,AG 5,0	1,5	ah,DS 3,5
7 221 84	90	3	101	3	105	3	ah,AG 5,0	1,5	ah,DS 3,5
7 236 38	79	3	90	3	93	3		1,5	
7 112 08	69	3	80	3		3	0,4	1,5	
7 112 09	69	3	80	3		3	0,4	1,5	
7 112 00	69	3	80	3		3	0,4	1,5	
7 205 47	81,1	3	92,1	3	95,2	3	ah,D 2.4	1,5	
7 205 49	82,1	3	93,1	3	95,6	3	ah,D 1.9	1,5	
7 112 50	62	3	73	3	80	3	0,4	1,5	
7 112 51	60	3	71	3	76	3	0,4	1,5	
7 112 52	65	3	76	3	81	3	0,6	1,5	
7 112 53	70,8	3	81,8	3	86,1	3	0,5	1,5	
7 112 54	63,9	3	74,9	3	81	3	0,2	1,5	
7 112 55	66,3	3	77,3	3	81	3	0,3	1,5	
7 112 56	66,8	3	77,8	3	81	3	0,3	1,5	
7 229 43	74	3	85	3	96	3		1,5	
7 229 44	74	3	85	3	96	3		1,5	
7 229 42	72	3	83	3	84	3		1,5	
7 271 04	81	3	92	3	96	3	ah,D 3,5	1,5	ah,D 5,5
7 271 03	81	3	92	3	96	3	ah,D 3,5	1,5	ah,D 5,5
9 20 27	68	3	81	3		3	<2,5	1,5	
9 20 28	68	3	81	3		3	<2,5	1,5	
7 205 51	82	3	93	3	96	3	3	1,5	
7 105 04	75	3	86	3	89	3	1,8	1,5	
7 223 16	84	3	95	3	97	3	ah,SG (Ø 25 mm) 4,7	1,5	
7 223 17	84	3	95	3	97	3	ah,SG (Ø 25 mm) 4,7	1,5	ah,SG (Ø 50 mm) 7,9
7 223 18	84	3	95	3	97	3	ah,SG (Ø 25 mm) 5,3	1,5	
7 223 19	84	3	95	3	97	3	ah,SG (Ø 25 mm) 5,3	1,5	ah,SG (Ø 50 mm) 11,4
7 223 24	83	3	94	3	95	3	ah,SG (Ø 25 mm) 4,8	1,5	
7 223 25	83	3	94	3	95	3	ah,SG (Ø 25 mm) 1,0	1,5	ah,P 1,5
7 223 20	84	3	95	3	97	3	ah,SG (Ø 25 mm) 1,9	1,5	ah,SG (Ø 50 mm) 2,9
7 223 21	85	3	96	3	98	3	ah,SG (Ø 25 mm) 9,7	1,5	



Part number	Sound pressure level LpA (dB)	Uncertainty of measured value KpA (dB)	Sound power level LWA (dB)	Uncertainty of measured value KWA (dB)	Sound peak value LpCpeak (dB)	Uncertainty of measured value KpC (dB)	Vibration value 1 ahv 3-way (m/s <sup>2</sup> )	Vibration value 2 ahv 3-way (m/s <sup>2</sup> )	Uncertainty of measured value Ka (m/s <sup>2</sup> )
7 223 22	85	3	96	3	98	3	ah,SG (Ø 25 mm) 9,7	1,5	
7 223 23	85	3	96	3	98	3	ah,SG (Ø 25 mm) 1,5	1,5	ah,SG (Ø 50 mm) 4,5
7 221 86	90	3	101	3	105	3	ah,AG 7,9	1,5	ah,DS 1,5
7 221 87	90	3	101	3	105	3	ah,AG 7,9	1,5	ah,DS 1,5
7 221 88	90	3	101	3	105	3	ah,AG 7,3	1,5	ah,DS 1,5
7 221 89	90	3	101	3	105	3	ah,AG 7,3	1,5	ah,DS 1,5
7 221 90	90	3	101	3	105	3	ah,AG 5,9	1,5	ah,DS 2,1
7 221 91	90	3	101	3	105	3	ah,AG 5,9	1,5	ah,DS 2,1
7 221 92	90	3	101	3	105	3	ah,AG 5,0	1,5	ah,DS 1,6
7 221 93	90	3	101	3	105	3	ah,AG 5,0	1,5	ah,DS 1,6
7 221 94	90	3	101	3	105	3	ah,AG 3,4	1,5	ah,DS 1,6
7 221 95	90	3	101	3	105	3	ah,AG 3,4	1,5	ah,DS 1,6
7 115 03	93,8	3	104,8	3	112	3	14,5	1,5	
7 116 10	74	3	75,5	3	86,5	3	1,0	1,5	
7 113 21	65,9	3	76,9	3	78,9	3	ah 0.4	1,5	
7 113 20	65,6	3	76,6	3	78,4	3	1	1,5	
7 129 15	70	3	81	3	83	3		1,5	
7 129 12	74	3	85	3	87	3		1,5	
7 222 07	90	3	101	3	105	3	ah,AG 5,0	1,5	ah,DS 3,5
7 222 08	90	3	101	3	105	3	ah,AG 5,0	1,5	ah,DS 3,5
7 222 09	90	3	101	3	105	3	ah,AG 5,0	1,5	ah,DS 3,5
7 222 10	90	3	101	3	105	3	ah,AG 5,0	1,5	ah,DS 3,5
7 222 11	90	3	101	3	105	3	ah,AG 5,0	1,5	ah,DS 3,5
7 222 12	90	3	101	3	105	3	ah,AG 5,0	1,5	ah,DS 3,5
7 222 13	90	3	101	3	105	3	ah,AG 4,1	1,5	ah,DS 2,2
7 222 18	90	3	101	3	105	3	ah,AG 5,9	1,5	ah,DS 2,1
7 222 19	90	3	101	3	105	3	ah,AG 5,9	1,5	ah,DS 2,1
7 222 20	90	3	101	3	105	3	ah,AG 5,0	1,5	ah,DS 1,6
7 222 21	90	3	101	3	105	3	ah,AG 5,0	1,5	ah,DS 1,6
7 222 22	90	3	101	3	105	3	ah,AG 3,4	1,5	ah,DS 1,6
7 222 23	90	3	101	3	105	3	ah,AG 3,4	1,5	ah,DS 1,6
7 129 27	83	3	94	3	97	3		1,5	
7 129 25	70	3	81	3	83	3		1,5	
7 129 26	70	3	81	3	83	3		1,5	
7 109 01	75	3	86	3	91	3	2,7	1,5	
7 209 38	82	3	93	3	96	3	<1.5	1,5	
7 129 22	74	3	85	3	87	3		1,5	
7 229 52	72	3	83	3	84	3		1,5	
7 229 54	74	3	85	3	96	3		1,5	
7 229 53	74	3	85	3	96	3		1,5	

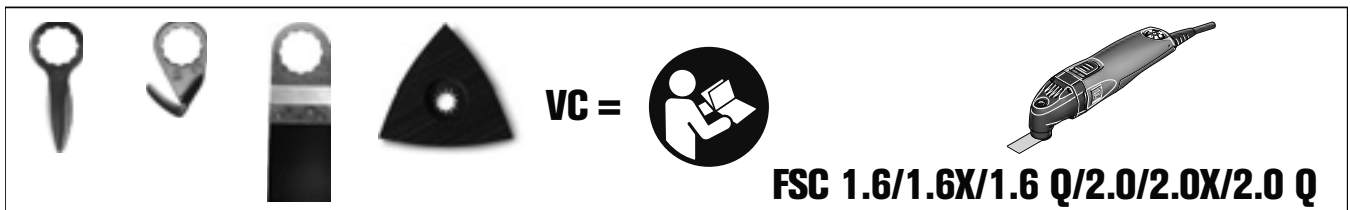

	VC		VC		VC
6 35 02 102 ...	2	6 39 03 083 ...	2	6 39 03 161 ...	3
6 35 02 103 ...	2	6 39 03 087 ...	2	6 39 03 162 ...	3
6 35 02 115 ...	2	6 39 03 095 ...	2	6 39 03 163 ...	2
6 35 02 116 ...	2	6 39 03 097 ...	3	6 39 03 164 ...	2
6 35 02 119 ...	3	6 39 03 099 ...	4	6 39 03 166 ...	3
6 35 02 120 ...	4	6 39 03 101 ...	3	6 39 03 168 ...	4
6 35 02 121 ...	4	6 39 03 103 ...	2	6 39 03 169 ...	4
6 35 02 122 ...	4	6 39 03 104 ...	2	6 39 03 170 ...	4
6 35 02 123 ...	4	6 39 03 105 ...	3	6 39 03 171 ...	4
6 35 02 124 ...	4	6 39 03 107 ...	3	6 39 03 172 ...	2
6 35 02 135 ...	3	6 39 03 108 ...	2	6 39 03 173 ...	2
6 35 02 136 ...	4	6 39 03 109 ...	2	6 39 03 174 ...	3
6 35 02 137 ...	2	6 39 03 110 ...	2	6 39 03 176 ...	3
6 35 02 138 ...	3	6 39 03 111 ...	4	6 39 03 179 ...	4
6 35 02 145 ...	2	6 39 03 113 ...	3	6 39 03 181 ...	3
6 35 02 147 ...	3	6 39 03 114 ...	3	6 39 03 182 ...	5
6 35 02 148 ...	3	6 39 03 115 ...	2	6 39 03 183 ...	2
6 35 02 158 ...	2	6 39 03 116 ...	4	6 39 03 184 ...	2
6 35 02 162 ...	4	6 39 03 117 ...	4	6 39 03 185 ...	2
6 35 02 163 ...	4	6 39 03 118 ...	2	6 39 03 186 ...	2
6 35 02 164 ...	3	6 39 03 120 ...	2	6 39 03 189 ...	3
6 35 02 165 ...	4	6 39 03 121 ...	2	6 39 03 190 ...	4
6 35 02 167 ...	1	6 39 03 122 ...	2	6 39 03 191 ...	3
6 35 02 168 ...	1	6 39 03 123 ...	4	6 39 03 194 ...	4
6 35 02 172 ...	1	6 39 03 124 ...	2	6 39 03 195 ...	4
6 35 02 173 ...	1	6 39 03 125 ...	4	6 39 03 196 ...	3
6 35 02 185 ...	3	6 39 03 127 ...	2	6 39 03 198 ...	4
6 35 02 186 ...	2	6 39 03 128 ...	3	6 39 03 206 ...	3
6 37 06 018 ...	3	6 39 03 129 ...	3	6 39 03 207 ...	3
6 37 31 001 ...	1	6 39 03 131 ...	3	6 39 03 208 ...	3
6 37 31 002 ...	1	6 39 03 132 ...	3	6 39 03 209 ...	3
6 37 31 005 ...	1	6 39 03 133 ...	3	6 39 03 210 ...	3
6 38 06 129 ...	1	6 39 03 143 ...	4	6 39 03 211 ...	3
6 38 06 136 ...	1	6 39 03 144 ...	3	6 39 03 212 ...	2
6 38 06 140 ...	1	6 39 03 146 ...	3	6 39 03 217 ...	3
6 38 06 153 ...	1	6 39 03 147 ...	2	6 39 03 221 ...	5
6 38 06 195 ...	3	6 39 03 152 ...	3	6 39 03 222 ...	5
6 39 03 072 ...	2	6 39 03 153 ...	3	6 39 03 223 ...	5
6 39 03 073 ...	2	6 39 03 154 ...	3	6 39 03 227 ...	3
6 39 03 076 ...	2	6 39 03 155 ...	3	6 39 03 228 ...	5
6 39 03 079 ...	2	6 39 03 156 ...	3	6 39 03 229 ...	4
6 39 03 081 ...	4	6 39 03 157 ...	3	6 39 03 230 ...	5
6 39 03 082 ...	3	6 39 03 160 ...	4	6 39 03 231 ...	4





	FSC500QSL	AFSC18QSL		FSC500QSL	AFSC18QSL
	VC	VC		VC	VC
6 35 02 097 ...	0	0	6 37 31 001 ...	0	0
6 35 02 106 ...	0	0	6 37 31 002 ...	0	0
6 35 02 113 ...	0	0	6 37 31 006 ...	1	1
6 35 02 114 ...	0	0	6 38 06 129 ...	0	0
6 35 02 118 ...	0	0	6 38 06 136 ...	0	0
6 35 02 125 ...	0	0	6 38 06 140 ...	0	0
6 35 02 126 ...	1	1	6 38 06 141 ...	0	0
6 35 02 127 ...	1	2	6 38 06 142 ...	0	0
6 35 02 133 ...	1	1	6 38 06 159 ...	0	0
6 35 02 134 ...	1	2	6 38 06 195 ...	0	2
6 35 02 151 ...	1	1	6 38 10 031 ...	1	3
6 35 02 152 ...	1	1	6 39 03 165 ...	0	0
6 35 02 157 ...	1	1	6 39 03 200 ...	0	0
6 35 02 160 ...	1	1	6 39 03 201 ...	0	0
6 35 02 161 ...	1	2	6 39 03 202 ...	0	0
6 35 02 166 ...	0	1	6 39 03 226 ...	1	1
6 35 02 169 ...	0	1	6 39 03 233 ...	0	0
6 35 02 170 ...	0	1	6 39 03 234 ...	1	2
6 35 02 174 ...	0	0	6 39 03 235 ...	0	1
6 35 02 175 ...	0	1	6 39 03 236 ...	2	2
6 35 02 176 ...	0	1	6 39 03 237 ...	1	1
6 35 02 183 ...	1	1	6 39 03 238 ...	1	1
6 35 02 184 ...	0	0	6 39 03 239 ...	2	2
6 35 02 187 ...	0	1	6 39 03 240 ...	1	1
6 35 02 188 ...	0	1	6 39 03 241 ...	1	1
6 35 02 191 ...	1	1	6 39 03 242 ...	1	1
6 35 02 193 ...	1	1	6 39 03 243 ...	1	1
6 35 02 196 ...	1	1	6 39 03 244 ...	1	1
6 35 02 198 ...	1	1	6 39 03 245 ...	0	0
6 35 02 199 ...	1	1	6 39 03 246 ...	3	3
6 35 02 200 ...	1	2	6 39 03 247 ...	3	3
6 35 02 201 ...	1	2	6 39 03 248 ...	3	3
6 35 02 202 ...	1	2			
6 35 02 203 ...	1	2			
6 35 02 204 ...	1	1			
6 35 02 205 ...	1	1			
6 35 02 206 ...	1	1			
6 35 02 207 ...	1	1			
6 35 02 208 ...	1	2			
6 35 02 213 ...	0	1			
6 35 02 214 ...	0	1			
6 35 02 215 ...	0	1			
6 35 02 216 ...	0	0			
6 35 02 217 ...	0	1			
6 35 02 218 ...	0	1			
6 35 02 219 ...	0	1			
6 35 02 220 ...	0	1			
6 37 06 019 ...	0	0			
6 37 19 011 ...	1	1			



	AFMT12QSL AFMT12SL	AFMM18QSL	FMM250, 250Q, AFMM14, FMT250SL, 250QSL	FMM350QSL
	VC	VC	VC	VC
6 35 02 097 ...	0	0	2	0
6 35 02 106 ...	0	0	2	0
6 35 02 113 ...	0	0	2	0
6 35 02 114 ...	0	0	1	0
6 35 02 118 ...	0	0	2	0
6 35 02 125 ...	0	0	1	0
6 35 02 126 ...	1	1	4	1
6 35 02 127 ...	1	1	5	1
6 35 02 133 ...	1	1	4	1
6 35 02 134 ...	1	1	5	1
6 35 02 151 ...	1	1	4	1
6 35 02 152 ...	1	1	5	1
6 35 02 157 ...	1	1	3	0
6 35 02 160 ...	1	1	4	1
6 35 02 161 ...	1	1	5	1
6 35 02 166 ...	1	1	2	0
6 35 02 169 ...	1	1	3	0
6 35 02 170 ...	1	1	3	0
6 35 02 174 ...	0	0	3	0
6 35 02 175 ...	1	1	3	0
6 35 02 176 ...	1	1	3	0
6 35 02 183 ...	1	1	4	1
6 35 02 184 ...	0	0	3	0
6 35 02 187 ...	1	1	3	0
6 35 02 188 ...	1	1	2	0
6 35 02 191 ...	1	1	4	1
6 35 02 193 ...	1	1	4	1
6 35 02 196 ...	1	1	3	0
6 35 02 198 ...	1	1	4	1
6 35 02 199 ...	1	1	5	1
6 35 02 205 ...	1	1	4	1
6 35 02 206 ...	1	1	4	1
6 35 02 207 ...	1	1	5	1
6 35 02 208 ...	1	1	5	1
6 35 02 214 ...	1	1	3	0
6 35 02 216 ...	0	0	2	0
6 35 02 217 ...	1	1	2	0
6 35 02 219 ...	1	1	3	0
6 37 06 019 ...	0	0	3	0
6 37 19 011 ...	1	1	4	1
6 37 31 001 ...	1	0	2	0
6 37 31 002 ...	1	0	1	0
6 38 06 129 ...	0	0	1	0
6 38 06 136 ...	0	0	1	0
6 38 06 140 ...	0	0	1	0
6 38 06 141 ...	0	0	1	0
6 38 06 142 ...	0	0	1	0
6 38 06 159 ...	0	0	1	0
6 38 06 195 ...	1	3	3	1
6 38 10 031 ...	2	3	5	1
6 39 03 165 ...	0	0	3	0
6 39 03 200 ...	0	0	2	0
6 39 03 201 ...	0	0	2	0
6 39 03 202 ...	0	0	2	0
6 39 03 226 ...	1	1	4	1
6 39 03 233 ...	0	0	2	0
6 39 03 234 ...	1	2	4	1
6 39 03 235 ...	1	1	3	0
6 39 03 245 ...	0	0	3	0



**FEIN. Unverwüstliche  
Elektrowerkzeuge.**



**3 YEAR  
FEIN PLUS  
WARRANTY**

**3-year FEIN PLUS warranty:**

**Register and obtain 3-year warranty.**

Simply register your device online and extend your warranty to 3 years.

**[www.fein.com/warranty](http://www.fein.com/warranty)**

Warranty hotline:

Tel: 01327 308730

Email: [tech@fein-uk.co.uk](mailto:tech@fein-uk.co.uk)

**FEIN repair service.**

"FEIN UK" is your central partner for handling repair and warranty orders.

Maintenance, repairs and safety checks for all FEIN products are handled rapidly and efficiently.

Contact:

Tel: 01327 308730

Email: [tech@fein-uk.co.uk](mailto:tech@fein-uk.co.uk)

UK: FEIN Industrial Power Tools UK Ltd.

4 Badby Park · Heartlands Business Park

Daventry, Northants. NN11 8YT.

Tel. No. 01327 308730 · Fax. No. 01327 308739

[www.fein-uk.co.uk](http://www.fein-uk.co.uk) and [www.grit-uk.co.uk](http://www.grit-uk.co.uk)

**Effective from 01/2018**

Non-binding price recommendations excluding VAT: Dated 01/2018. With this price list all previous price lists become invalid. The prices valid on the day of delivery are correct for invoice purposes. Subject to print errors and modifications concerning technique, shape and layout.