



**FEIN. Unverwüstliche  
Elektrowerkzeuge.**



## **FEIN Price Catalogue machines and accessories 2017**





# Welcome to FEIN – your specialist in metal and interiors.

FEIN is synonymous with extremely reliable application solutions for manual trades and industry when working with metal, timber and composite materials.



Application solutions for drilling, core drilling, sanding, screwdriving and surface processing – FEIN's wide yet specialised range of power tools and accessories makes it a specialist for the metal industry. 50 years ago, FEIN invented the oscillating multi-tool. Since then, tradesmen have put their trust in THE ORIGINAL. What's more, FEIN provides specific processing solutions for timber and composite materials too.

## We shape the future. 150 years of FEIN. An eternal promise.



Founded in 1867 by Wilhelm Emil Fein, FEIN is now one of the world's leading power tool manufacturers. Right from the start, the end user has always been at the heart of everything we do and will continue to be so.



As a specialist in solutions, we develop tools, accessories and consumables, which simplify work for users in the areas of metal, timber and composite materials. All developed and produced by FEIN.

As the inventor of the drill, development is part and parcel of our philosophy. For 150 years, we have been developing and building power tools for the future to perfect and simplify the work of our customers on a daily basis.



We shape the future



**2017**  
4-speed cordless drill/driver  
with QuickIN MAX



**2016**  
Oscillating multi-tool  
with Starlock tool  
mounting



**1987**  
First safety angle grinder



**1967**  
The first oscillating  
multi-tool



**1914**  
The FEIN hammer

**1895**  
The world's first power  
tool – the drill.



**1867**  
The founder



W. E. Fein



## Cordless tools

Drill/Driver	6	MULTIMASTER / MULTITALENT	36	Tappers	57
Cordless screw gun	16	SUPERCUT	40	SuperWire	59
Cordless impact wrench/driver	20	Cordless sheet metal processing	48		
FEIN AccuTEC	27	Drills	53		

## Drilling

Drills	62	Magnetic drill jigs	73		
Angle drills	72	Tappers	76		

## Fastening

Metal screw gun	80	Dry wall screw guns	81		
-----------------	----	---------------------	----	--	--

## Grinding

Compact angle grinders	86	Die Grinders	100	High Frequency Straight Grinders	111
Angle Grinders	95	HF-angle grinder	106	Frequency converter	115

## Sheet metal working

Slitting shears	122	Sheet metal shears	125	Nibblers	128
-----------------	-----	--------------------	-----	----------	-----

## Sawing and cutting

Jigsaws	136	Pipe Saws	139	Construction cutter	143
---------	-----	-----------	-----	---------------------	-----

## Metal core drilling

Mobile	146	Compact	151	Automatic	174
Economical	151	Universal	158		

## Wet / dry dust extractor

Wet / dry dust extractor	180				
--------------------------	-----	--	--	--	--

## Surface processing

Sanders	188	Polishers	202		
---------	-----	-----------	-----	--	--

## Oscillating multi-tool

FEIN MULTIMASTER / MULTITALENT	210	FEIN SUPERCUT CONSTRUCTION	214	FEIN SUPERCUT AUTOMOTIVE	239
--------------------------------	-----	----------------------------	-----	--------------------------	-----

## Stationary belt grinders

GRIT GHB hand-guided belt grinder	248	GRIT GX basic belt grinder for manual trades	252	GRIT GI basic belt grinder for industry	255
GRIT GHB add-on modules	250	GRIT GX add-on modules for manual trades	254	GRIT GI add-on modules for industry	258

## Accessories

Balancers	270				
-----------	-----	--	--	--	--

## Accessories, numerical part



Machines in numerical order	274	Accessories in numerical order	280	Vibration and noise emission values	319
-----------------------------	-----	--------------------------------	-----	-------------------------------------	-----



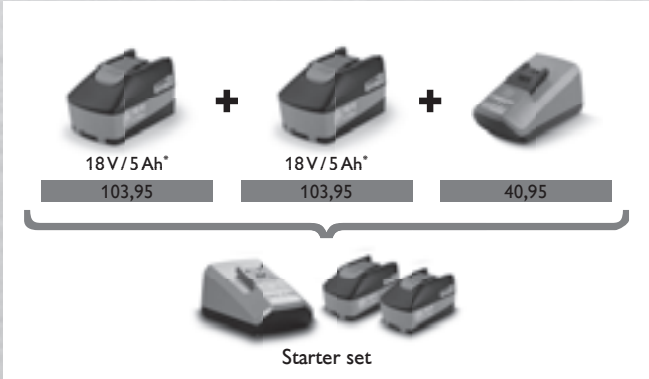

# Simple: The new FEIN cordless pricing system. Individual or part of a set – the price is always the same.

You can now flexibly add to your range of FEIN batteries and cordless products at any time: It doesn't matter whether tools or batteries are bought individually or as part of a set, the total price is always the same. So the new FEIN pricing systems pays off with its total cost transparency and absolute freedom of choice and you don't pay a higher price even if you buy later on.

## The FEIN cordless pricing system for tools and batteries with 18 V.

 <p>ASCM 18 QM Select</p> <p>261,45</p>	+	 <p>18 V / 5 Ah* 103,95</p> <p>18 V / 5 Ah* 103,95</p> <p>40,95</p> <p>Starter set</p> <p>248,85</p>	=	 <p>Basic set</p> <p>510,30</p>
---	---	---	---	---

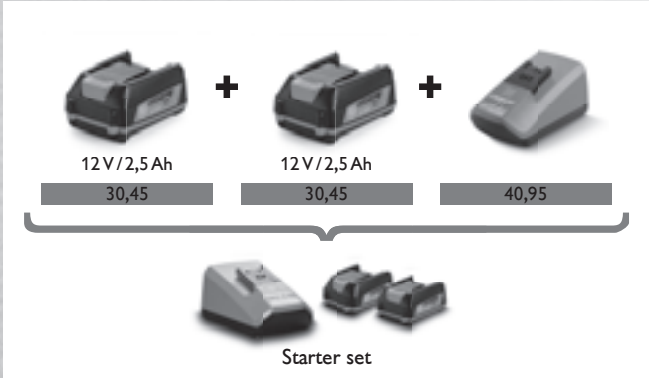
## Same pricing system, different performance data – for tools and batteries with 12 V.

 <p>ASCM 12 Q Select</p> <p>170,10</p>	+	 <p>12 V / 2,5 Ah 30,45</p> <p>12 V / 2,5 Ah 30,45</p> <p>40,95</p> <p>Starter set</p> <p>101,85</p>	=	 <p>Basic set</p> <p>271,95</p>
---	---	--	---	--

\* Also available with 18 V / 2.5 Ah.



# Brilliant all round: FEIN's range of batteries and cordless products – unique, flexible and simple.

FEIN's range of batteries and cordless products for metal processing and oscillating multi-tools includes powerful tools in 12 V and 18 V. FEIN provides the 3-year FEIN PLUS warranty for all devices – including Li-ion batteries and chargers.

Simply register the product within 6 weeks of purchase at [www.fein.com/warranty](http://www.fein.com/warranty)

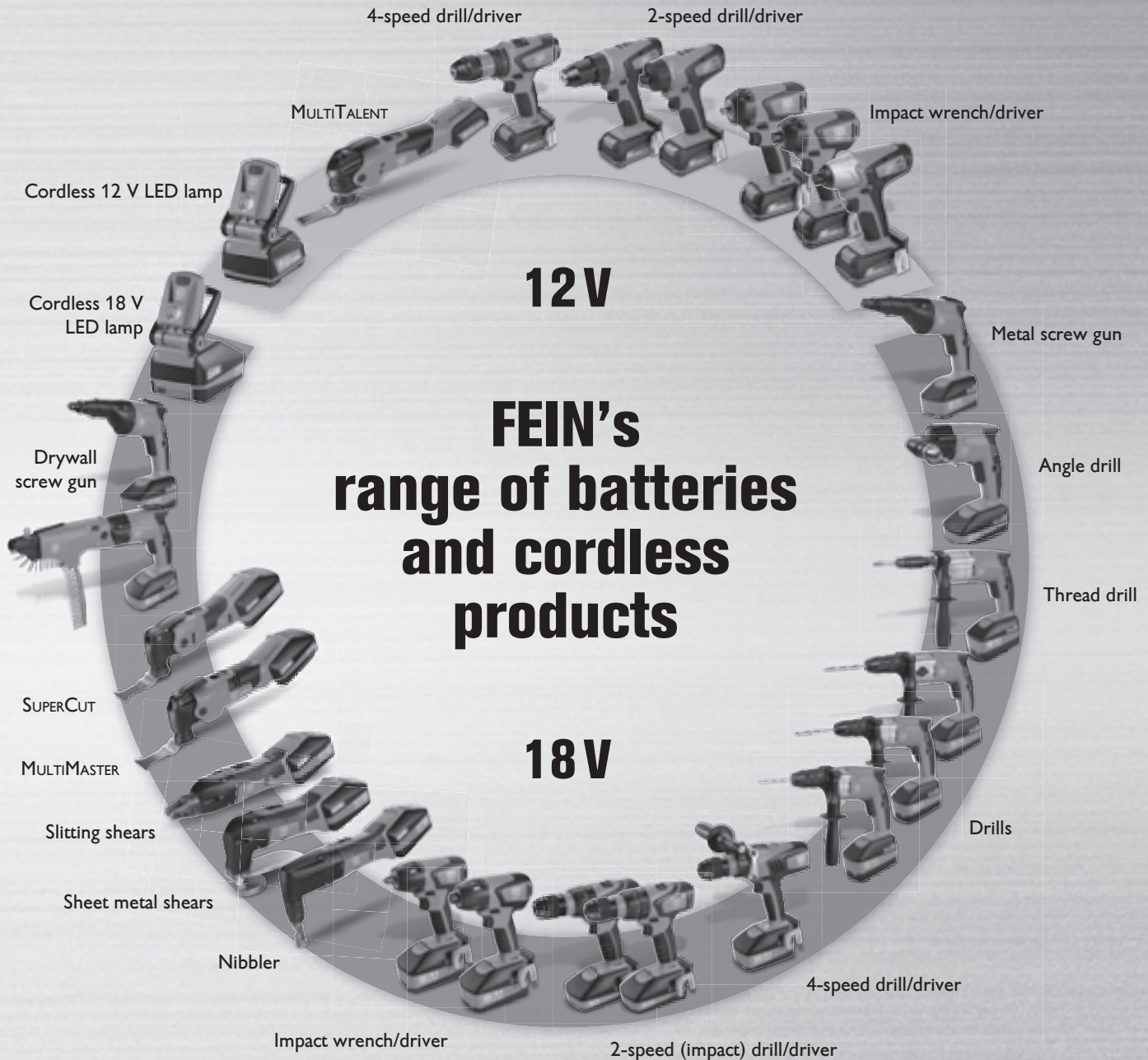

## The FEIN cordless range – unique, reliable and extremely durable.

The FEIN range of cordless tools features powerful 18 and 12 V products. Special highlights include the FEIN brushless PowerDrive motor for high efficiency and maximum service life, and the MultiVolt interface for using all FEIN Li-ion batteries (12-18V) on these tools. All FEIN Li-ion batteries feature the new SafetyCell technology. A separate communication cable protects the battery and tool from damage due to overload – making the FEIN battery technology long-lasting and safe. FEIN provides the 3-year FEIN PLUS warranty for all cordless tools (including Li-ion batteries and charger). Simply register the product within 6 weeks of purchase at [www.fein.com/warranty](http://www.fein.com/warranty).



---

### Drill/Driver Page 6

The optimum combination of flexibility, power and reliability. Designed for drilling, tapping and screwdriving in metal.

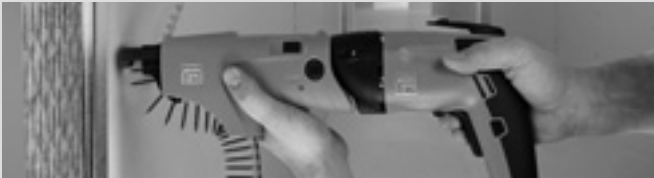

---

### Cordless screw gun Page 16

The specialists in drywall construction and self-drilling screwdriving in metal construction. Precise results obtained through deactivation via depth stop or via torque.



---

### Cordless impact wrench/driver Page 20

Unbeatably efficient and always reliable. Wide ranges of use and can withstand permanent loads.



---

### FEIN AccuTec Page 27

Long-life precision cordless drill/driver for soft and hard screw connections in industrial volume production.



---

### MULTIMASTER / MULTITALENT Page 36

The universal system for interior work and renovation.





**SUPERCUT**

**Page**

**40**

The most powerful system for interior work and renovation.



**Cordless sheet metal processing**

**Page**

**48**

Powerful and curve-compatible cordless nibbler and cordless shears for cutting out and trimming in sheet metal, profiles and spiral seam pipes.



**Drills**

**Page**

**53**

Perfectly suited to the job. Precise, powerful, easy to use.



**Tappers**

**Page**

**57**

Efficient, precise and reliable. The alternative to working by hand.



**SuperWire**

**Page**

**59**

Wire glass removal system for vehicle glazing.



	ASCM 18 QM	ASCM 18 QM Select	Professional set for ASCM 18 QM tapping	ABS 18 QC	ABS 18 Q Select	Professional set for ABS 18 QC tapping
	4-speed cordless drill/driver with brushless motor and QuickIN MAX interface. No compromise on performance for drilling and tapping up to 12 mm and drilling with carbide hole saws.		4-speed cordless drill/driver with brushless motor, QuickIN Max interface and extensive accessories for drilling, tapping and screwdriving in metal.	2-speed cordless drill/driver with brushless motor and QuickIN interface. Perfectly suited to drilling and tapping up to 10 mm.		2-speed cordless drill/driver with brushless motor, QuickIN interface and extensive accessories for drilling, tapping and screwdriving in metal.
<b>Page</b>	8	8	9	9	10	10
<b>Technical features</b>	Battery voltage	18 V	18 V	18 V	18 V	18 V
	Battery capacity	5 Ah	5 Ah	2,5 Ah	2,5 Ah	2,5 Ah
	Motor	brushless	brushless	brushless	brushless	brushless
	Gearbox	4-speed	4-speed	2-speed	2-speed	2-speed
	Interface	QuickIN MAX	QuickIN MAX	QuickIN	QuickIN	QuickIN
	Max. torque (hard/soft)	90 / 45 Nm	90 / 45 Nm	60 / 32 Nm	60 / 32 Nm	60 / 32 Nm
	Torque levels	15 + 1	15 + 1	22 + 1	22 + 1	22 + 1
	Capacity in steel Ø	25 mm	25 mm	13 mm	13 mm	13 mm
	Capacity in wood Ø	50 mm	50 mm	50 mm	50 mm	50 mm
	Tapping	M 12	M 12	M 10	M 10	M 10
	Weight with battery	2,2 kg	2,2 kg	1,7 kg	1,7 kg	1,7 kg
	Weight without storage battery	1,5 kg	1,5 kg	1,3 kg	1,3 kg	1,3 kg
	Removable drill chuck	●	●	●	●	●

- included





	ASCM 12 QC	ASCM 12 Q Select	Professional set for ASCM 12 QC tapping	ABSU 12 C	ABSU 12 Select	ABSU 12 W4C	ABSU 12 W4 Select
	4-speed cordless drill/driver with brushless motor and QuickIN interface. Perfectly suited to drilling and tapping up to 8 mm and screwdriving.		4-speed cordless drill/driver with brushless motor, QuickIN interface and extensive accessories for drilling, tapping and screwdriving in metal.	2-speed cordless drill/driver with solid metal drill chuck. Perfect for universal drilling and screwdriving up to 6 mm.		2-speed cordless drill/driver with 1/4" tool mounting. Powerful torque for screw connections up to 6 x 200 mm.	
	11	11	12	12	13	13	13
	12 V	12 V	12 V	12 V	12 V	12 V	12 V
	2,5 Ah		2,5 Ah	2,5 Ah		2,5 Ah	
	brushless	brushless	brushless	2-pole DC	2-pole DC	2-pole DC	2-pole DC
	4-speed	4-speed	4-speed	2-speed	2-speed	2-speed	2-speed
	QuickIN	QuickIN	QuickIN				
	40 / 20 Nm	40 / 20 Nm	40 / 20 Nm	20 / 14 Nm	20 / 14 Nm	20 / 14 Nm	20 / 14 Nm
	20 + 1	20 + 1	20 + 1	17 + 1	17 + 1	17 + 1	17 + 1
	13 mm	13 mm	13 mm	10 mm	10 mm		
	40 mm	40 mm	40 mm	30 mm	30 mm		
	M 8	M 8	M 8	M 6	M 6		
	1,3 kg		1,3 kg	1,2 kg		1,1 kg	
	1,1 kg	1,1 kg	1,1 kg	1 kg	1 kg	0,8 kg	0,8 kg
	•	•	•				

**ASCM 18 QM**

4-speed cordless drill/driver with brushless motor and QuickIN MAX interface. No compromise on performance for drilling and tapping up to 12 mm and drilling with carbide hole saws.



For accessories, see page 14

Battery voltage	V	18
Battery capacity	Ah	5
Motor		brushless
Gearbox		4-speed
Interface		QuickIN MAX
Speed, no load	1/min	400 / 800 / 1 950 / 3 850
Max. torque (hard/soft)	Nm	90 / 45
Torque levels		15 + 1
Drill chuck clamping width	mm	1,5 - 13
Fastening	mm	10 x 400
Capacity in steel Ø	mm	25
Capacity in wood Ø	mm	50
Tapping		M 12
Weight with battery	kg	2,2
Weight without storage battery	kg	1,5
<b>Part number</b>		<b>7 116 11 61 00 0</b>
<b>EAN</b>		<b>4014586887456</b>
<b>Price in € [PC18]</b>		<b>510,30</b>

**FEIN benefits:**

- ▶ Brushless FEIN PowerDrive motor, fully encapsulated and dust-protected with 30% higher efficiency and long service life.
- ▶ 4-speed solid metal gearbox. Optimum cutting speeds for drilling in metal and self-drilling screwdriving.
- ▶ QuickIN MAX accessory interface for all QuickIN and QuickIN MAX accessories. Quick change between applications.
- ▶ High torques up to 90 Nm.
- ▶ Including QuickIN solid metal drill chuck (120 Nm) with carbide-tipped clamping jaws and high clamping forces.
- ▶ In speed 4, optimum speeds (3 850 rpm) for small diameters.
- ▶ In speed 3, optimum speeds (1 950 rpm) for 8 mm diameters.
- ▶ Speed 1 for powerful thread cutting.
- ▶ Suitable for carbide hole saws up to 25 mm.
- ▶ Electronic torque setting.
- ▶ Fixes 10 x 400 mm screws without pre-drilling.
- ▶ 2 200 screw connections (5 x 40 mm) with one battery charge (5 Ah).
- ▶ One charger for all FEIN Li-ion batteries of all voltage classes.
- ▶ The battery charge can be read off the battery.
- ▶ FEIN SafetyCell technology. Protects the battery and tool from overload, overheating and total discharge.
- ▶ 3-year FEIN PLUS warranty including battery and charger.

**Price includes:**

1 cordless drill/driver, 2 battery packs (Li-ion), 1 rapid charger ALG 50, 1 QuickIN drill chuck (120 Nm), 1 belt clip, 1 bit holder, 1 handle, 1 plastic carrying case

**ASCM 18 QM Select**

4-speed cordless drill/driver with brushless motor and QuickIN MAX interface. No compromise on performance for drilling and tapping up to 12 mm and drilling with carbide hole saws.



For accessories, see page 14

Battery voltage	V	18
Motor		brushless
Gearbox		4-speed
Interface		QuickIN MAX
Speed, no load	1/min	400 / 800 / 1 950 / 3 850
Max. torque (hard/soft)	Nm	90 / 45
Torque levels		15 + 1
Drill chuck clamping width	mm	1,5 - 13
Fastening	mm	10 x 400
Capacity in steel Ø	mm	25
Capacity in wood Ø	mm	50
Tapping		M 12
Weight without storage battery	kg	1,5
<b>Part number</b>		<b>7 116 11 64 00 0</b>
<b>EAN</b>		<b>4014586887340</b>
<b>Price in € [PC18]</b>		<b>261,45</b>

**FEIN benefits:**

- ▶ Brushless FEIN PowerDrive motor, fully encapsulated and dust-protected with 30% higher efficiency and long service life.
- ▶ 4-speed solid metal gearbox. Optimum cutting speeds for drilling in metal and self-drilling screwdriving.
- ▶ QuickIN MAX accessory interface for all QuickIN and QuickIN MAX accessories. Quick change between applications.
- ▶ High torques up to 90 Nm.
- ▶ Including QuickIN solid metal drill chuck (120 Nm) with carbide-tipped clamping jaws and high clamping forces.
- ▶ In speed 4, optimum speeds (3 850 rpm) for small diameters.
- ▶ In speed 3, optimum speeds (1 950 rpm) for 8 mm diameters.
- ▶ Speed 1 for powerful thread cutting.
- ▶ Suitable for carbide hole saws up to 25 mm.
- ▶ Electronic torque setting.
- ▶ Fixes 10 x 400 mm screws without pre-drilling.
- ▶ 2 200 screw connections (5 x 40 mm) with one battery charge (5 Ah).
- ▶ One charger for all FEIN Li-ion batteries of all voltage classes.
- ▶ The battery charge can be read off the battery.
- ▶ FEIN SafetyCell technology. Protects the battery and tool from overload, overheating and total discharge.
- ▶ 3-year FEIN PLUS warranty including battery and charger.

**Price includes:**

1 cordless drill/driver, 1 QuickIN drill chuck (120 Nm), 1 belt clip, 1 bit holder, 1 handle, 1 plastic carrying case



**Professional set for  
ASCM 18 QM tapping**

For accessories, see page 14

4-speed cordless drill/driver with brushless motor, QuickIN Max interface and extensive accessories for drilling, tapping and screwdriving in metal.

Battery voltage	V	18
Battery capacity	Ah	5
Motor		brushless
Gearbox		4-speed
Interface		QuickIN MAX
Speed, no load	1/min	400 / 800 / 1 950 / 3 850
Max. torque (hard/soft)	Nm	90 / 45
Torque levels		15 + 1
Drill chuck clamping width	mm	1,5 - 13
Fastening	mm	10 x 400
Capacity in steel Ø	mm	25
Capacity in wood Ø	mm	50
Tapping		M 12
Weight with battery	kg	2,2
Weight without storage battery	kg	1,5
<b>Part number</b>		<b>7 116 11 63 00 0</b>
<b>EAN</b>		<b>4014586887333</b>
<b>Price in € [PC18]</b>		<b>615,30</b>

**FEIN benefits:**

- ▶ Brushless FEIN PowerDrive motor, fully encapsulated and dust-protected with 30% higher efficiency and long service life.
- ▶ 4-speed solid metal gearbox. Optimum cutting speeds for drilling in metal and self-drilling screwdriving.
- ▶ QuickIN MAX accessory interface for all QuickIN and QuickIN MAX accessories. Quick change between applications.
- ▶ High torques up to 90 Nm.
- ▶ Including QuickIN solid metal drill chuck (120 Nm) with carbide-tipped clamping jaws and high clamping forces.
- ▶ In speed 4, optimum speeds (3 850 rpm) for small diameters.
- ▶ In speed 3, optimum speeds (1 950 rpm) for 8 mm diameters.
- ▶ Speed 1 for powerful thread cutting.
- ▶ Suitable for carbide hole saws up to 25 mm.
- ▶ Electronic torque setting.
- ▶ Fixes 10 x 400 mm screws without pre-drilling.
- ▶ 2 200 screw connections (5 x 40 mm) with one battery charge (5 Ah).
- ▶ One charger for all FEIN Li-ion batteries of all voltage classes.
- ▶ The battery charge can be read off the battery.
- ▶ FEIN SafetyCell technology. Protects the battery and tool from overload, overheating and total discharge.
- ▶ 3-year FEIN PLUS warranty including battery and charger.
- ▶ Including QuickIN bit holder (1/4") with convenient one-handed operation and powerful neodymium magnet.
- ▶ Including QuickIN tapping adapter with 2 collets for shank diameter of 4.5 mm and 6 mm to cut thread sizes M4 / M5 / M6 / M8.
- ▶ Including QuickIN socket adapter to hold sockets with 1/2" square holder.

**Price includes:**

1 cordless drill/driver, 2 battery packs (Li-ion), 1 rapid charger ALG 50, 1 QuickIN drill chuck (120 Nm), 1 belt clip, 1 bit holder, 1 handle, 1 plastic carrying case, 1 QuickIN bit holder (1/4"), 1 QuickIN tapping adapter with 2 collets, 1 QuickIN socket adapter (1/2")

**ABS 18 QC**

For accessories, see page 14

2-speed cordless drill/driver with brushless motor and QuickIN interface. Perfectly suited to drilling and tapping up to 10 mm.

Battery voltage	V	18
Battery capacity	Ah	2,5
Motor		brushless
Gearbox		2-speed
Interface		QuickIN
Speed, no load	1/min	450 / 2 000
Max. torque (hard/soft)	Nm	60 / 32
Torque levels		22 + 1
Drill chuck clamping width	mm	1,5 - 13
Fastening	mm	8 x 300
Capacity in steel Ø	mm	13
Capacity in wood Ø	mm	50
Tapping		M 10
Weight with battery	kg	1,7
Weight without storage battery	kg	1,3
<b>Part number</b>		<b>7 113 22 62 00 0</b>
<b>EAN</b>		<b>4014586887159</b>
<b>Price in € [PC18]</b>		<b>405,30</b>

**FEIN benefits:**

- ▶ Brushless FEIN PowerDrive motor with 30% higher efficiency and long service life.
- ▶ QuickIN accessory interface for all QuickIN accessories. Quick change between applications.
- ▶ MultiVolt interface. Cordless tool can be operated with all FEIN Li-ion batteries (12-18 V).
- ▶ 2-speed solid metal gearbox for drilling in metal and self-drilling screwdriving.
- ▶ Including QuickIN solid metal drill chuck (120 Nm) with carbide-tipped clamping jaws and high clamping forces.
- ▶ Mechanical torque setting.
- ▶ Compact design.
- ▶ 750 screw connections (5 x 40 mm) with one battery charge (2.5 Ah).
- ▶ One charger for all FEIN Li-ion batteries of all voltage classes.
- ▶ The battery charge can be read off the battery.
- ▶ FEIN SafetyCell technology. Protects the battery and tool from overload, overheating and total discharge.
- ▶ 3-year FEIN PLUS warranty including battery and charger.

**Price includes:**

1 cordless drill/driver, 2 battery packs (Li-ion), 1 rapid charger ALG 50, 1 QuickIN drill chuck (120 Nm), 1 belt clip, 1 bit holder, 1 plastic carrying case

**ABS 18 Q Select**

New 2017  
**FEIN SELECT<sup>+</sup>**



For accessories, see page 14

2-speed cordless drill/driver with brushless motor and QuickIN interface. Perfectly suited to drilling and tapping up to 10 mm.

Battery voltage	V	18
Motor		brushless
Gearbox		2-speed
Interface		QuickIN
Speed, no load	1/min	450 / 2 000
Max. torque (hard/soft)	Nm	60 / 32
Torque levels		22 + 1
Drill chuck clamping width	mm	1,5 - 13
Fastening	mm	8 x 300
Capacity in steel Ø	mm	13
Capacity in wood Ø	mm	50
Tapping		M 10
Weight without storage battery	kg	1,3
<b>Part number</b>		<b>7 113 22 64 00 0</b>
<b>EAN</b>		<b>4014586887203</b>
<b>Price in € [PC18]</b>		<b>219,45</b>

**FEIN benefits:**

- ▶ Brushless FEIN PowerDrive motor with 30% higher efficiency and long service life.
- ▶ QuickIN accessory interface for all QuickIN accessories. Quick change between applications.
- ▶ MultiVolt interface. Cordless tool can be operated with all FEIN Li-ion batteries (12-18 V).
- ▶ 2-speed solid metal gearbox for drilling in metal and self-drilling screwdriving.
- ▶ Including QuickIN solid metal drill chuck (120 Nm) with carbide-tipped clamping jaws and high clamping forces.
- ▶ Mechanical torque setting.
- ▶ Compact design.
- ▶ 750 screw connections (5 x 40 mm) with one battery charge (2.5 Ah).
- ▶ One charger for all FEIN Li-ion batteries of all voltage classes.
- ▶ The battery charge can be read off the battery.
- ▶ FEIN SafetyCell technology. Protects the battery and tool from overload, overheating and total discharge.
- ▶ 3-year FEIN PLUS warranty including battery and charger.

**Price includes:**

1 cordless drill/driver, 1 QuickIN drill chuck (120 Nm), 1 belt clip, 1 bit holder, 1 plastic carrying case

**Professional set for ABS 18 QC tapping**

New 2017



For accessories, see page 14

2-speed cordless drill/driver with brushless motor, QuickIN interface and extensive accessories for drilling, tapping and screwdriving in metal.

Battery voltage	V	18
Battery capacity	Ah	2,5
Motor		brushless
Gearbox		2-speed
Interface		QuickIN
Speed, no load	1/min	450 / 2 000
Max. torque (hard/soft)	Nm	60 / 32
Torque levels		22 + 1
Drill chuck clamping width	mm	1,5 - 13
Fastening	mm	8 x 300
Capacity in steel Ø	mm	13
Capacity in wood Ø	mm	50
Tapping		M 10
Weight with battery	kg	1,7
Weight without storage battery	kg	1,3
<b>Part number</b>		<b>7 113 22 63 00 0</b>
<b>EAN</b>		<b>4014586887197</b>
<b>Price in € [PC18]</b>		<b>510,30</b>

**FEIN benefits:**

- ▶ Brushless FEIN PowerDrive motor with 30% higher efficiency and long service life.
- ▶ QuickIN accessory interface for all QuickIN accessories. Quick change between applications.
- ▶ MultiVolt interface. Cordless tool can be operated with all FEIN Li-ion batteries (12-18 V).
- ▶ 2-speed solid metal gearbox for drilling in metal and self-drilling screwdriving.
- ▶ Including QuickIN solid metal drill chuck (120 Nm) with carbide-tipped clamping jaws and high clamping forces.
- ▶ Mechanical torque setting.
- ▶ Compact design.
- ▶ 750 screw connections (5 x 40 mm) with one battery charge (2.5 Ah).
- ▶ One charger for all FEIN Li-ion batteries of all voltage classes.
- ▶ The battery charge can be read off the battery.
- ▶ FEIN SafetyCell technology. Protects the battery and tool from overload, overheating and total discharge.
- ▶ 3-year FEIN PLUS warranty including battery and charger.
- ▶ Including QuickIN bit holder (1/4") with convenient one-handed operation and powerful neodymium magnet.
- ▶ Including QuickIN tapping adapter with 2 collets for shank diameter of 4.5 mm and 6 mm to cut thread sizes M4 / M5 / M6 / M8.
- ▶ Including QuickIN socket adapter to hold sockets with 1/2" square holder.

**Price includes:**

1 cordless drill/driver, 2 battery packs (Li-ion), 1 rapid charger ALG 50, 1 QuickIN drill chuck (120 Nm), 1 belt clip, 1 bit holder, 1 plastic carrying case, 1 QuickIN bit holder (1/4"), 1 QuickIN tapping adapter with 2 collets, 1 QuickIN socket adapter (1/2")

**ASCM 12 QC**

4-speed cordless drill/driver with brushless motor and QuickIN interface. Perfectly suited to drilling and tapping up to 8 mm and screwdriving.



For accessories, see page 14

Battery voltage	V	12
Battery capacity	Ah	2,5
Motor		brushless
Gearbox		4-speed
Interface		QuickIN
Speed, no load	1/min	400 / 700 / 1 400 / 2 500
Max. torque (hard/soft)	Nm	40 / 20
Torque levels		20 + 1
Drill chuck clamping width	mm	1,5 - 13
Fastening	mm	8 x 200
Capacity in steel Ø	mm	13
Capacity in wood Ø	mm	40
Tapping		M 8
Weight with battery	kg	1,3
Weight without storage battery	kg	1,1
<b>Part number</b>		<b>7 116 10 61 00 0</b>
<b>EAN</b>		<b>4014586881447</b>
<b>Price in € [PC18]</b>		<b>271,95</b>

**FEIN benefits:**

- ▶ Brushless FEIN PowerDrive motor with 30% higher efficiency and long service life.
- ▶ 4-speed solid metal gearbox. Optimum cutting speeds for drilling in metal and self-drilling screwdriving.
- ▶ QuickIN accessory interface for all QuickIN accessories. Quick change between applications.
- ▶ High torques up to 40 Nm.
- ▶ Including small QuickIN solid metal drill chuck (60 Nm) with high concentricity.
- ▶ In speed 4, optimum speeds (2 500 rpm) for diameters of up to 6 mm.
- ▶ Mechanical torque setting.
- ▶ Can be set down safely on the battery.
- ▶ Slim handle.
- ▶ 400 screw connections (5 x 40 mm) with one battery charge (2.5 Ah).
- ▶ One charger for all FEIN Li-ion batteries of all voltage classes.
- ▶ The battery charge can be read off the battery.
- ▶ FEIN SafetyCell technology. Protects the battery and tool from overload, overheating and total discharge.
- ▶ 3-year FEIN PLUS warranty including battery and charger.

**Price includes:**

- 1 cordless drill/driver, 2 battery packs (Li-ion), 1 rapid charger ALG 50, 1 QuickIN drill chuck (60 Nm), 1 belt clip, 1 bit holder, 1 plastic carrying case

**ASCM 12 Q Select**

4-speed cordless drill/driver with brushless motor and QuickIN interface. Perfectly suited to drilling and tapping up to 8 mm and screwdriving.

**FEIN SELECT<sup>+</sup>**

For accessories, see page 14

Battery voltage	V	12
Motor		brushless
Gearbox		4-speed
Interface		QuickIN
Speed, no load	1/min	400 / 700 / 1 400 / 2 500
Max. torque (hard/soft)	Nm	40 / 20
Torque levels		20 + 1
Drill chuck clamping width	mm	1,5 - 13
Fastening	mm	8 x 200
Capacity in steel Ø	mm	13
Capacity in wood Ø	mm	40
Tapping		M 8
Weight without storage battery	kg	1,1
<b>Part number</b>		<b>7 116 10 64 00 0</b>
<b>EAN</b>		<b>4014586885698</b>
<b>Price in € [PC18]</b>		<b>170,10</b>

**FEIN benefits:**

- ▶ Brushless FEIN PowerDrive motor with 30% higher efficiency and long service life.
- ▶ 4-speed solid metal gearbox. Optimum cutting speeds for drilling in metal and self-drilling screwdriving.
- ▶ QuickIN accessory interface for all QuickIN accessories. Quick change between applications.
- ▶ High torques up to 40 Nm.
- ▶ Including small QuickIN solid metal drill chuck (60 Nm) with high concentricity.
- ▶ In speed 4, optimum speeds (2 500 rpm) for diameters of up to 6 mm.
- ▶ Mechanical torque setting.
- ▶ Can be set down safely on the battery.
- ▶ Slim handle.
- ▶ 400 screw connections (5 x 40 mm) with one battery charge (2.5 Ah).
- ▶ One charger for all FEIN Li-ion batteries of all voltage classes.
- ▶ The battery charge can be read off the battery.
- ▶ FEIN SafetyCell technology. Protects the battery and tool from overload, overheating and total discharge.
- ▶ 3-year FEIN PLUS warranty including battery and charger.

**Price includes:**

- 1 cordless drill/driver, 1 QuickIN drill chuck (60 Nm), 1 belt clip, 1 bit holder, 1 plastic carrying case

**Professional set for ASCM 12 QC tapping**



For accessories, see page 14

4-speed cordless drill/driver with brushless motor, QuickIN interface and extensive accessories for drilling, tapping and screwdriving in metal.

Battery voltage	V	12
Battery capacity	Ah	2,5
Motor		brushless
Gearbox		4-speed
Interface		QuickIN
Speed, no load	1/min	400 / 700 / 1 400 / 2 500
Max. torque (hard/soft)	Nm	40 / 20
Torque levels		20 + 1
Drill chuck clamping width	mm	1,5 - 13
Fastening	mm	8 x 200
Capacity in steel Ø	mm	13
Capacity in wood Ø	mm	40
Tapping		M 8
Weight with battery	kg	1,3
Weight without storage battery	kg	1,1
<b>Part number</b>		<b>7 116 10 62 00 0</b>
<b>EAN</b>		<b>4014586886961</b>
<b>Price in € [PC18]</b>		<b>376,95</b>

**FEIN benefits:**

- ▶ Brushless FEIN PowerDrive motor with 30% higher efficiency and long service life.
- ▶ 4-speed solid metal gearbox. Optimum cutting speeds for drilling in metal and self-drilling screwdriving.
- ▶ QuickIN accessory interface for all QuickIN accessories. Quick change between applications.
- ▶ High torques up to 40 Nm.
- ▶ Including small QuickIN solid metal drill chuck (60 Nm) with high concentricity.
- ▶ In speed 4, optimum speeds (2 500 rpm) for diameters of up to 6 mm.
- ▶ Mechanical torque setting.
- ▶ Can be set down safely on the battery.
- ▶ Slim handle.
- ▶ 400 screw connections (5 x 40 mm) with one battery charge (2.5 Ah).
- ▶ One charger for all FEIN Li-ion batteries of all voltage classes.
- ▶ The battery charge can be read off the battery.
- ▶ FEIN SafetyCell technology. Protects the battery and tool from overload, overheating and total discharge.
- ▶ 3-year FEIN PLUS warranty including battery and charger.
- ▶ Including QuickIN bit holder (1/4") with convenient one-handed operation and powerful neodymium magnet.
- ▶ Including QuickIN tapping adapter with 2 collets for shank diameter of 4.5 mm and 6 mm to cut thread sizes M4 / M5 / M6 / M8.
- ▶ Including QuickIN socket adapter to hold sockets with 1/2" square holder.

**Price includes:**

1 cordless drill/driver, 2 battery packs (Li-ion), 1 rapid charger ALG 50, 1 QuickIN drill chuck (60 Nm), 1 belt clip, 1 bit holder, 1 plastic carrying case, 1 QuickIN bit holder (1/4"), 1 QuickIN tapping adapter with 2 collets, 1 QuickIN socket adapter (1/2")

**ABSU 12 C**



For accessories, see page 14

2-speed cordless drill/driver with solid metal drill chuck. Perfect for universal drilling and screwdriving up to 6 mm.

Battery voltage	V	12
Battery capacity	Ah	2,5
Motor		2-pole DC
Gearbox		2-speed
Speed, no load	1/min	400 / 1 300
Max. torque (hard/soft)	Nm	20 / 14
Torque levels		17 + 1
Drill chuck clamping width	mm	1 - 10
Fastening	mm	6 x 200
Capacity in steel Ø	mm	10
Capacity in wood Ø	mm	30
Tapping		M 6
Weight with battery	kg	1,2
Weight without storage battery	kg	1
<b>Part number</b>		<b>7 113 20 61 00 0</b>
<b>EAN</b>		<b>4014586881485</b>
<b>Price in € [PC18]</b>		<b>182,70</b>

**FEIN benefits:**

- ▶ Powerful and long-life DC motor with overheating and overload protection.
- ▶ 2-speed solid metal gearbox for universal drilling and screwdriving.
- ▶ Robust solid metal drill chuck with chucking force safety device.
- ▶ Mechanical torque setting.
- ▶ Can be set down safely on the battery.
- ▶ Slim handle.
- ▶ Compact design.
- ▶ 350 screw connections (5 x 40 mm) with one battery charge (2.5 Ah).
- ▶ One charger for all FEIN Li-ion batteries of all voltage classes.
- ▶ The battery charge can be read off the battery.
- ▶ FEIN SafetyCell technology. Protects the battery and tool from overload, overheating and total discharge.
- ▶ 3-year FEIN PLUS warranty including battery and charger.

**Price includes:**

1 cordless drill/driver, 2 battery packs (Li-ion), 1 rapid charger ALG 50, 1 belt clip, 1 bit holder, 1 plastic carrying case





**ABSU 12 Select**

2-speed cordless drill/driver with solid metal drill chuck. Perfect for universal drilling and screwdriving up to 6 mm.

**FEIN SELECT<sup>+</sup>**



For accessories, see page 14

Battery voltage	V	12
Motor		2-pole DC
Gearbox		2-speed
Max. torque (hard/soft)	Nm	20 / 14
Torque levels		17 + 1
Drill chuck clamping width	mm	1 - 10
Fastening	mm	6 x 200
Capacity in steel Ø	mm	10
Capacity in wood Ø	mm	30
Tapping		M 6
Weight without storage battery	kg	1
<b>Part number</b>		<b>7 113 20 64 00 0</b>
<b>EAN</b>		<b>4014586885568</b>
<b>Price in € [PC18]</b>		<b>80,85</b>

**FEIN benefits:**

- ▶ Powerful and long-life DC motor with overheating and overload protection.
- ▶ 2-speed solid metal gearbox for universal drilling and screwdriving.
- ▶ Robust solid metal drill chuck with chucking force safety device.
- ▶ Mechanical torque setting.
- ▶ Can be set down safely on the battery.
- ▶ Slim handle.
- ▶ Compact design.
- ▶ 350 screw connections (5 x 40 mm) with one battery charge (2.5 Ah).
- ▶ One charger for all FEIN Li-ion batteries of all voltage classes.
- ▶ The battery charge can be read off the battery.
- ▶ FEIN SafetyCell technology. Protects the battery and tool from overload, overheating and total discharge.
- ▶ 3-year FEIN PLUS warranty including battery and charger.

**Price includes:**

1 cordless drill/driver, 1 belt clip, 1 bit holder, 1 plastic carrying case

**ABSU 12 W4C**

2-speed cordless drill/driver with 1/4" tool mounting. Powerful torque for screw connections up to 6 x 200 mm.



For accessories, see page 14

Battery voltage	V	12
Battery capacity	Ah	2,5
Motor		2-pole DC
Gearbox		2-speed
Speed, no load	1/min	400 / 1 300
Max. torque (hard/soft)	Nm	20 / 14
Torque levels		17 + 1
Fastening	mm	6 x 200
Tool Holder		1/4" hexagonal holder
Weight with battery	kg	1,1
Weight without storage battery	kg	0,8
<b>Part number</b>		<b>7 113 21 61 00 0</b>
<b>EAN</b>		<b>4014586881539</b>
<b>Price in € [PC18]</b>		<b>177,45</b>

**FEIN benefits:**

- ▶ Powerful and long-life DC motor with overheating and overload protection.
- ▶ 2-speed solid metal gearbox for universal screwdriving.
- ▶ Short and light thanks to 1/4" tool mounting and the fact that there is no drill chuck.
- ▶ Mechanical torque setting.
- ▶ Can be set down safely on the battery.
- ▶ Slim handle.
- ▶ Very short design of 155 mm.
- ▶ 350 screw connections (5 x 40 mm) with one battery charge (2.5 Ah).
- ▶ One charger for all FEIN Li-ion batteries of all voltage classes.
- ▶ The battery charge can be read off the battery.
- ▶ FEIN SafetyCell technology. Protects the battery and tool from overload, overheating and total discharge.
- ▶ 3-year FEIN PLUS warranty including battery and charger.

**Price includes:**

1 cordless drill/driver, 2 battery packs (Li-ion), 1 rapid charger ALG 50, 1 belt clip, 1 bit holder, 1 plastic carrying case

**ABSU 12 W4 Select**

2-speed cordless drill/driver with 1/4" tool mounting. Powerful torque for screw connections up to 6 x 200 mm.

**FEIN SELECT<sup>+</sup>**



For accessories, see page 14

Battery voltage	V	12
Motor		2-pole DC
Gearbox		2-speed
Speed, no load	1/min	400 / 1 300
Max. torque (hard/soft)	Nm	20 / 14
Torque levels		17 + 1
Fastening	mm	6 x 200
Tool Holder		1/4" hexagonal holder
Weight without storage battery	kg	0,8
<b>Part number</b>		<b>7 113 21 64 00 0</b>
<b>EAN</b>		<b>4014586885575</b>
<b>Price in € [PC18]</b>		<b>75,60</b>

**FEIN benefits:**

- ▶ Powerful and long-life DC motor with overheating and overload protection.
- ▶ 2-speed solid metal gearbox for universal screwdriving.
- ▶ Short and light thanks to 1/4" tool mounting and the fact that there is no drill chuck.
- ▶ Mechanical torque setting.
- ▶ Can be set down safely on the battery.
- ▶ Slim handle.
- ▶ Very short design of 155 mm.
- ▶ 350 screw connections (5 x 40 mm) with one battery charge (2.5 Ah).
- ▶ One charger for all FEIN Li-ion batteries of all voltage classes.
- ▶ The battery charge can be read off the battery.
- ▶ FEIN SafetyCell technology. Protects the battery and tool from overload, overheating and total discharge.
- ▶ 3-year FEIN PLUS warranty including battery and charger.

**Price includes:**

1 cordless drill/driver, 1 belt clip, 1 bit holder, 1 plastic carrying case

**General accessories**



**Cordless ALED 12-18 V LED lamp**  
Compact and durable cordless LED lamp with swivel-mounted lamp head. Compatible with all 12 / 14 / 18 V FEIN Li-ion batteries, including hook for attaching the lamp. Extremely lightweight at 130 g and very bright at 900 Lux. Colour temperature is the equivalent of daylight. The brightness can be set to 2 levels.

Part number	Price in €
9 26 04 200 02 0	52,50



**Tool case**  
Plastic, inner dimensions: 470 x 275 x 116 mm

Part number	Price in €
3 39 01 118 01 0	37,26



**Tool case**  
Suitable for ABSU 12, ASCD 12, ASCM 12

Part number	Price in €
3 39 01 160 01 0	22,13



**Plastic box**  
Box insert with lockable lid for small parts and accessories, suitable for tool box 3 39 01 118 01 0, max 5 items/box.

Part number	Price in €
3 39 01 119 00 0	3,97



**Quick charger ALG 50**  
For all FEIN Li-ion batteries. Charge time from 35 min.

Part number	Price in €
9 26 04 129 01 0	40,95



**Quick charger ALG 30**  
For FEIN NiCd and Li-ion batteries. Charge time from 25 min.

Part number	Price in €
9 26 04 096 01 0	142,80



**Tool holder 1/4" external hexagon**  
1/4" Drive-Hex Socket with quick-change chuck

Ø mm	L mm	Part number	Price in €
15	51	6 05 10 011 00 9	18,17

**18 V battery**



**Battery pack**  
Li-ion with charge status indicator and FEIN SafetyCell Technology. Protects the battery and tool from overload, overheating and total discharge.

Current/Voltages V	Capacity Ah	Part number	Price in €
18	5	9 26 04 173 02 0	103,95
18	2,5	9 26 04 171 02 0	72,45



**Battery starter set**  
Very durable, light 18 V Li-ion batteries with innovative SafetyCell technology, 5 Ah capacity and charge indicator.

Part number	Price in €
9 26 04 300 03 0	248,85



**Battery starter set**  
Small and light 18 V Li-ion batteries with innovative SafetyCell technology, 2.5 Ah capacity and charge indicator.

Part number	Price in €
9 26 04 300 04 0	185,85

**12 V battery**



**Battery pack**  
Li-ion with charge status indicator and FEIN SafetyCell Technology. Protects the battery and tool from overload, overheating and total discharge.

Current/Voltages V	Capacity Ah	Part number	Price in €
12	2,5	9 26 04 168 02 0	30,45



**Battery starter set**  
Very durable, light 12 V Li-ion batteries with innovative SafetyCell technology, 2,5 Ah capacity and charge indicator.

Part number	Price in €
9 26 04 250 01 0	101,85

**Other accessories**



**Drill chuck**  
Small solid metal drill chuck from Röhm, maximum torque 60 Nm. Compatible with all FEIN cordless drill/drivers with QuickIN/QuickIN MAX interface.

Interface	Part number	Price in €
QuickIN	6 32 08 002 01 0	30,93



**Drill chuck**  
Solid metal drill chuck from Röhm with carbide-tipped clamping jaws and high clamping forces. Screwdriver bit may remain in the drive shaft, the drill chuck moves above the bit. Maximum torque 120 Nm. Compatible with all FEIN cordless drill/drivers with QuickIN/QuickIN MAX interface.

Interface	Part number	Price in €
QuickIN	6 32 08 005 01 0	41,77



**Bit holder**

1/4" hexagon socket bit holder with convenient one-handed operation and powerful neodymium magnet. Use of the bit holder makes the screwdriver lighter and shorter. Compatible with all FEIN cordless drill/drivers with QuickIN/QuickIN MAX interface.

Interface	Part number	Price in €
QuickIN	6 05 10 222 01 0	31,06



**Socket adapter**

Socket adapter to hold sockets with 1/2" square holder. Compatible with all FEIN cordless drill/drivers with QuickIN/QuickIN MAX interface.

Interface	Part number	Price in €
QuickIN	6 42 03 002 01 0	31,06



**Tapping adapter**

Tapping adapter with 2 collets for shank diameter of 4.5 mm and 6 mm to cut thread sizes M4 / M5 / M6 / M8. Reliable thread drill hold on the square, preventing slipping. Compatible with all FEIN cordless drill/drivers with QuickIN/QuickIN MAX interface.

Interface	Part number	Price in €
QuickIN	6 42 03 003 01 0	73,90



**Collets**

for collets and floating collet chucks  
M2 (DIN 352, DIN 371), M4 (DIN 357, DIN 376)

Ø mm	Square mm	Part number	Price in €
2,8	2,1	6 32 06 077 00 1	22,74



**Collets**

for collets and floating collet chucks  
M3 (DIN 352, DIN 371), M5 (DIN 357, DIN 376)

Ø mm	Square mm	Part number	Price in €
3,5	2,7	6 32 06 064 00 1	22,74



**Collets**

for collets and floating collet chucks  
M4 (DIN 352, DIN 371), M6 (DIN 357, DIN 376)

Ø mm	Square mm	Part number	Price in €
4,5	3,4	6 32 06 065 00 5	22,74



**Collets**

for collets and floating collet chucks  
M5 (DIN 352, DIN 371), M6 (DIN 352), M7 (DIN 352), M8 (DIN 352, DIN 357, DIN 376)

Ø mm	Square mm	Part number	Price in €
6	4,9	6 32 06 066 00 8	22,74



**Collets**

for collets and floating collet chucks  
M7 (DIN 371), M9 (DIN 352) M 10 (DIN 352, DIN 357, DIN 376)

Ø mm	Square mm	Part number	Price in €
7	5,5	6 32 06 070 00 6	22,74



**Collets**

for collets and floating collet chucks  
M8 (DIN 371), M11 (DIN 352)

Ø mm	Square mm	Part number	Price in €
8	6,2	6 32 06 078 00 9	22,74



**Collets**

for collets and floating collet chucks  
M12 (DIN 357, DIN 371, DIN 376)

Ø mm	Square mm	Part number	Price in €
9	7	6 32 06 075 00 4	22,74



**Collets**

for collets and floating collet chucks  
M10 (DIN 371)

Ø mm	Square mm	Part number	Price in €
10	8	6 32 06 079 00 3	22,09



		ASCS 6.3 Select	ASCT 18 M Select	ASCT 18 Select
		Speed-optimised cordless drill/driver for screw connections in metal up to a diameter of 6.3 mm.	Powerful autofeed screwdriver for more than 2 300 repeated screw fittings per battery charge.	Very powerful cordless drywall screw gun with outstanding service life.
<b>Page</b>		17	17	18
<b>Technical features</b>	Battery voltage	18 V	18 V	18 V
	Speed, no load	0 - 1 700 1/min	0 - 4 000 1/min	0 - 4 000 1/min
	Max. torque (hard/soft)	30 / 10 Nm	14 / 7 Nm	14 / 7 Nm
	Screw Ø	6,3 mm	4,2 mm	4,2 mm
	Rapid change chuck	1/4"	1/4"	1/4"
	Weight without storage battery	1,1 kg	1 kg	1,5 kg



ASCS 6.3

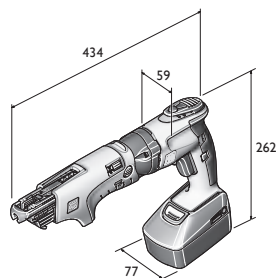

ASCT 18 M

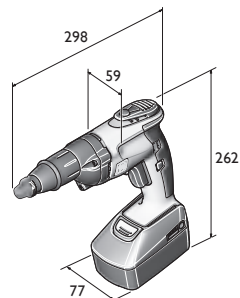

ASCT 18



**ASCS 6.3 Select**

Speed-optimised cordless drill/driver for screw connections in metal up to a diameter of 6.3 mm.

**FEIN SELECT<sup>+</sup>**

For accessories, see page 18

For mains variant of tool, see page 80

Battery voltage	V	18
Speed, full load	1/min	0 - 1 500
Speed, no load	1/min	0 - 1 700
Max. torque (hard/soft)	Nm	30 / 10
Screw Ø	mm	6,3
Rapid change chuck		1/4"
Weight without storage battery	kg	1,1
<b>Part number</b>		<b>7 113 11 63 00 0</b>
<b>EAN</b>		<b>4014586881461</b>
<b>Price in € [PC01]</b>		<b>261,45</b>

**FEIN benefits:**

- ▶ Powerful battery for more than 150 screw connections in 1.25 mm trapezoidal sheet metal on to 2 mm steel.
- ▶ Electronic torque shut-off for precise results even without a depth stop.
- ▶ Brushless FEIN PowerDrive motor, fully encapsulated and dust-protected with 30% higher efficiency and long service life.
- ▶ Tested for more than 1 million screw connections.
- ▶ More than 1 000 charge cycles per battery pack.
- ▶ Extremely light weight.
- ▶ Optimum ergonomics with gun handle for high contact pressure.
- ▶ Powerful up to 30 Nm.

**Price includes:**

1 ASCS 6.3 in plastic tool case, 1 hook, 1 depth stop, 1 insert for hexagon bolts SW 8

**ASCT 18 M Select**

Powerful autofeed screwdriver for more than 2 300 repeated screw fittings per battery charge.

**FEIN SELECT<sup>+</sup>**

For accessories, see page 18

For mains variant of tool, see page 80

Battery voltage	V	18
Speed, full load	1/min	0 - 2 700
Speed, no load	1/min	0 - 4 000
Max. torque (hard/soft)	Nm	14 / 7
Screw Ø	mm	4,2
Screw length	mm	25 - 55
Rapid change chuck		1/4"
Weight without storage battery	kg	1
<b>Part number</b>		<b>7 113 16 64 00 0</b>
<b>EAN</b>		<b>4014586887555</b>
<b>Price in € [PC01]</b>		<b>376,95</b>

**FEIN benefits:**

- ▶ Suited to all screwdriving applications in drywall construction, including high-strength chipboard and hard sheets of drywall.
- ▶ Low weight and perfect weight distribution for fatigue-free working.
- ▶ Brushless FEIN PowerDrive motor, fully encapsulated and dust-protected with 30% higher efficiency and long service life.
- ▶ One of the lightest screwdrivers in its class.
- ▶ Rapid charger for continuous working without interruption.
- ▶ 2 000 charge cycles per battery pack.
- ▶ Quiet and vibration-free cut-off with FEIN CLIC-STOP clutch.
- ▶ The particularly dust-resistant magazine can be inserted and removed without the use of tools and is easy to clean.
- ▶ Market-leading ergonomics with FEIN Sensitive handle.
- ▶ Easily adjustable and replaceable depth stop.
- ▶ Dustproof stop sleeve.

**Price includes:**

1 cordless drywall screw gun, 1 Collated cartridge for collated screws, 1 long bit for magazine screw connections, 1 bit with dust protection ring, 1 bit holder, 1 depth stop, 1 hook, 1 belt clip, 1 plastic carrying case

**ASCT 18 Select**

Very powerful cordless drywall screw gun with outstanding service life.

**FEIN SELECT<sup>+</sup>**



For accessories, see page 18  
For mains variant of tool, see page 80

Battery voltage	V	18
Speed, full load	1/min	0 - 2 700
Speed, no load	1/min	0 - 4 000
Max. torque (hard/soft)	Nm	14 / 7
Screw Ø	mm	4,2
Rapid change chuck		1/4"
Weight without storage battery	kg	1,5
<b>Part number</b>		<b>7 113 16 65 00 0</b>
<b>EAN</b>		<b>4014586887562</b>
<b>Price in € [PC01]</b>		<b>271,95</b>

**FEIN benefits:**

- ▶ Suited to all screwdriving applications in drywall construction, including high-strength chipboard and hard sheets of drywall.
- ▶ Low weight and perfect weight distribution for fatigue-free working.
- ▶ Brushless FEIN PowerDrive motor, fully encapsulated and dust-protected with 30% higher efficiency and long service life.
- ▶ One of the lightest screwdrivers in its class.
- ▶ Rapid charger for continuous working without interruption.
- ▶ 2 000 charge cycles per battery pack.
- ▶ Market-leading ergonomics with FEIN Sensitive handle.
- ▶ Quiet and vibration-free cut-off with FEIN CLIC-STOP clutch.
- ▶ Rapid changeover to collated strip magazine.
- ▶ Easily adjustable and replaceable depth stop.
- ▶ Dustproof stop sleeve.

**Price includes:**

1 cordless drywall screw gun, 1 bit with dust protection ring, 1 bit holder, 1 depth stop, 1 hook, 1 belt clip, 1 plastic carrying case

**Cordless screw gun**

**General accessories**



**Tool case**

Plastic, inner dimensions: 470 x 275 x 116 mm

Part number	Price in €
3 39 01 118 01 0	37,26



**Plastic box**

Box insert with lockable lid for small parts and accessories, suitable for tool box 3 39 01 118 01 0, max 5 items/box.

Part number	Price in €
3 39 01 119 00 0	3,97



**Quick charger ALG 50**

For all FEIN Li-ion batteries. Charge time from 35 min.

Part number	Price in €
9 26 04 129 01 0	40,95



**Quick charger ALG 30**

For FEIN NiCd and Li-ion batteries. Charge time from 25 min.

Part number	Price in €
9 26 04 096 01 0	142,80



**Tool holder 1/4" external hexagon**

1/4" Drive-Hex Socket with quick-change chuck

Ø mm	L mm	Part number	Price in €
15	51	6 05 10 011 00 9	18,17



**Bits 1/4" Hex socket**

Form H/Phillips (pack of 5) extra hard, with dust protection ring

L mm	Size	Part number	Price in €
25	2	6 27 12 109 03 4	7,96



**Tool holder 1/4" external hexagon**

1/4" Drive-Hex Socket with spring washer, magnetic

Ø mm	L mm	Part number	Price in €
10,6	45	6 05 10 215 00 3	22,52



**18 V battery**



**Battery pack**

Li-ion with charge status indicator and FEIN SafetyCell Technology. Protects the battery and tool from overload, overheating and total discharge.

Current/Voltages	Capacity	Part number	Price in €
V	Ah		
18	5	9 26 04 173 02 0	103,95
18	2,5	9 26 04 171 02 0	72,45



**Battery starter set**

Very durable, light 18 V Li-ion batteries with innovative SafetyCell technology, 5 Ah capacity and charge indicator.

Part number	Price in €
9 26 04 300 03 0	248,85



**Battery starter set**

Small and light 18 V Li-ion batteries with innovative SafetyCell technology, 2.5 Ah capacity and charge indicator.

Part number	Price in €
9 26 04 300 04 0	185,85

**Accessories for autofeed screwdrivers**



**M55 X magazine**

for collated screws of 25 to 55 mm length and max. Ø 5 mm, tool-free changeover, weight 0.4 kg.

Part number	Price in €
9 01 04 009 01 0	198,45

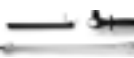

**M55 X magazine extension with belt guide**

Length 520 mm

Part number	Price in €
9 01 04 010 01 0	199,21



**Bits 1/4" Hex socket**

for screwdriving into ceilings and floors  
Form H/Phillips, size 2

Part number	Price in €
6 05 03 306 00 8	7,43



**High-speed construction screws**

Fine-pitch screw for fastening drywall to metal substructures, countersunk head, Ø 8 mm

Ø mm	L mm	No. in pack pcs	Part number	Price in €
3,9	35	1 000	6 39 01 030 01 4	44,94
3,9	35	10 000	6 39 01 030 02 0	265,65



**High-speed construction screws**

Coarse-pitch screw for fastening drywall to wood substructures, countersunk head, Ø 8 mm

Ø mm	L mm	No. in pack pcs	Part number	Price in €
3,9	30	1 000	6 39 01 031 01 3	44,94
3,9	30	10 000	6 39 01 031 02 0	265,65
3,9	35	1 000	6 39 01 032 01 6	44,94
3,9	35	10 000	6 39 01 032 02 0	265,65
3,9	45	1 000	6 39 01 033 01 0	58,49
3,9	45	10 000	6 39 01 033 02 0	345,78



**High-speed construction screws**

Double threaded with milled rib for fastening Fermacell panels to metal or wood substructures.

Ø mm	L mm	No. in pack pcs	Part number	Price in €
3,9	30	1 000	6 39 01 034 01 8	48,68
3,9	30	10 000	6 39 01 034 02 0	345,78



**High-speed construction screws**

Double threaded with milled rib for wood substructures.

Ø mm	L mm	No. in pack pcs	Part number	Price in €
4,2	35	1 000	6 39 01 035 01 2	56,72
4,2	35	10 000	6 39 01 035 02 0	335,30



	ASCD 18-300 W2	ASCD 18-300 W2 Select	ASCD 18-200 W4	ASCD 18-200 W4 Select
	Cordless impact wrench/driver with brushless motor and 6-stage torque setting. For metric screwdriving applications up to M18.		Impact wrench/driver with brushless motor and 6-stage torque setting. For universal screwdriving applications including self-drilling screwdriving.	
<b>Page</b>	22	22	22	23
<b>Technical features</b>	Battery voltage	18 V	18 V	18 V
	Battery capacity	5 Ah	5 Ah	5 Ah
	Motor	brushless	brushless	brushless
	Speed, no load	0 - 1 700 1/min	0 - 1 700 1/min	0 - 1 500 1/min
	Impacts	0 - 3 400 1/min	0 - 3 400 1/min	0 - 3 000 1/min
	Max. torque	290 Nm	290 Nm	210 Nm
	Max. metric screw	M18 (8.8)	M18 (8.8)	
	Wood screw Ø	8 x 300 mm	8 x 300 mm	8 x 200 mm
	Weight with battery	1,7 kg		1,7 kg
	Weight without storage battery	1 kg	1 kg	1 kg

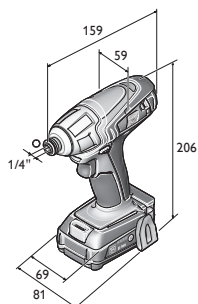

ASCD 12-100 W4C





	ASCD 12-150 W8C	ASCD 12-150 W8 Select	ASCD 12-150 W4C	ASCD 12-150 W4 Select	ASCD 12-100 W4C	ASCD 12-100 W4 Select
	Cordless impact wrench/driver with brushless motor and 6-stage torque setting. For metric screwdriving applications up to M14.		Impact wrench/driver with brushless motor and 6-stage torque setting. For universal screwdriving applications including self-drilling screwdriving.		Cordless impact wrench/driver with DC motor. For universal screw connections.	
	23	23	24	24	25	25
	12 V	12 V	12 V	12 V	12 V	12 V
	2,5 Ah		2,5 Ah		2,5 Ah	
	brushless	brushless	brushless	brushless	2-pole DC	2-pole DC
	0 - 1 800 1/min	0 - 1 800 1/min	0 - 1 700 1/min	0 - 1 700 1/min	0 - 2 700 1/min	0 - 2 700 1/min
	0 - 3 600 1/min	0 - 3 600 1/min	0 - 3 400 1/min	0 - 3 400 1/min	0 - 3 450 1/min	0 - 3 450 1/min
	135 Nm	135 Nm	135 Nm	135 Nm	100 Nm	100 Nm
	M14 (8.8)	M14 (8.8)				
	8 x 100 mm	8 x 100 mm	8 x 100 mm	8 x 100 mm	8 x 80 mm	8 x 80 mm
	1,1 kg		1,1 kg		1,1 kg	
	0,85 kg	0,85 kg	0,85 kg	0,85 kg	0,9 kg	0,9 kg

**ASCD 18-300 W2**

New 2017



For accessories, see page 26

Cordless impact wrench/driver with brushless motor and 6-stage torque setting. For metric screwdriving applications up to M18.

Battery voltage	V	18
Battery capacity	Ah	5
Motor		brushless
Speed, no load	1/min	0 - 1 700
Impacts	1/min	0 - 3 400
Max. torque	Nm	290
Torque levels		6
Tool Holder		1/2" Outer square
Max. metric screw		M18 (8.8)
Wood screw Ø	mm	8 x 300
Weight with battery	kg	1,7
Weight without storage battery	kg	1
<b>Part number</b>		<b>7 115 06 61 00 0</b>
<b>EAN</b>		<b>4014586887418</b>
<b>Price in € [PC18]</b>		<b>510,30</b>

**FEIN benefits:**

- ▶ Brushless FEIN PowerDrive motor with 30% higher efficiency and long service life.
- ▶ Electronic 6-stage torque setting prevents screw heads from being torn off.
- ▶ 10% more torque in reverse running to loosen screws which are extremely tight.
- ▶ MultiVolt interface. Cordless tool can be operated with all FEIN Li-ion batteries (12-18 V).
- ▶ 1/2" square for holding sockets.
- ▶ Robust solid metal impact gear.
- ▶ Metric screws up to M18 (8.8).
- ▶ Contact guard on gearbox head.
- ▶ Compact design.
- ▶ One charger for all FEIN Li-ion batteries of all voltage classes.
- ▶ The battery charge can be read off the battery.
- ▶ FEIN SafetyCell technology. Protects the battery and tool from overload, overheating and total discharge.
- ▶ 3-year FEIN PLUS warranty including battery and charger.

**Price includes:**

1 cordless impact wrench/driver, 2 battery packs (Li-ion), 1 rapid charger ALG 50, 1 belt clip, 1 bit holder, 1 plastic carrying case

**ASCD 18-300 W2 Select**

New 2017

FEIN SELECT<sup>+</sup>



For accessories, see page 26

Cordless impact wrench/driver with brushless motor and 6-stage torque setting. For metric screwdriving applications up to M18.

Battery voltage	V	18
Motor		brushless
Speed, no load	1/min	0 - 1 700
Impacts	1/min	0 - 3 400
Max. torque	Nm	290
Torque levels		6
Tool Holder		1/2" Outer square
Max. metric screw		M18 (8.8)
Wood screw Ø	mm	8 x 300
Weight without storage battery	kg	1
<b>Part number</b>		<b>7 115 06 64 00 0</b>
<b>EAN</b>		<b>4014586887425</b>
<b>Price in € [PC18]</b>		<b>261,45</b>

**FEIN benefits:**

- ▶ Brushless FEIN PowerDrive motor with 30% higher efficiency and long service life.
- ▶ Electronic 6-stage torque setting prevents screw heads from being torn off.
- ▶ 10% more torque in reverse running to loosen screws which are extremely tight.
- ▶ MultiVolt interface. Cordless tool can be operated with all FEIN Li-ion batteries (12-18 V).
- ▶ 1/2" square for holding sockets.
- ▶ Robust solid metal impact gear.
- ▶ Metric screws up to M18 (8.8).
- ▶ Contact guard on gearbox head.
- ▶ Compact design.
- ▶ One charger for all FEIN Li-ion batteries of all voltage classes.
- ▶ The battery charge can be read off the battery.
- ▶ FEIN SafetyCell technology. Protects the battery and tool from overload, overheating and total discharge.
- ▶ 3-year FEIN PLUS warranty including battery and charger.

**Price includes:**

1 cordless impact wrench/driver, 1 belt clip, 1 bit holder, 1 plastic carrying case

**ASCD 18-200 W4**

New 2017



For accessories, see page 26

Impact wrench/driver with brushless motor and 6-stage torque setting. For universal screwdriving applications including self-drilling screwdriving.

Battery voltage	V	18
Battery capacity	Ah	5
Motor		brushless
Speed, no load	1/min	0 - 1 500
Impacts	1/min	0 - 3 000
Max. torque	Nm	210
Torque levels		6
Tool Holder		1/4" hexagon socket
Wood screw Ø	mm	8 x 200
Weight with battery	kg	1,7
Weight without storage battery	kg	1
<b>Part number</b>		<b>7 115 07 61 00 0</b>
<b>EAN</b>		<b>4014586887432</b>
<b>Price in € [PC18]</b>		<b>499,80</b>

**FEIN benefits:**

- ▶ Brushless FEIN PowerDrive motor with 30% higher efficiency and long service life.
- ▶ Electronic 6-stage torque setting prevents screw heads from being torn off.
- ▶ 10% more torque in reverse running to loosen screws which are extremely tight.
- ▶ MultiVolt interface. Cordless tool can be operated with all FEIN Li-ion batteries (12-18 V).
- ▶ 1/4" hexagon socket for holding bits and socket wrench inserts.
- ▶ Robust solid metal impact gear.
- ▶ Contact guard on gearbox head.
- ▶ Compact design.
- ▶ One charger for all FEIN Li-ion batteries of all voltage classes.
- ▶ The battery charge can be read off the battery.
- ▶ FEIN SafetyCell technology. Protects the battery and tool from overload, overheating and total discharge.
- ▶ 3-year FEIN PLUS warranty including battery and charger.

**Price includes:**

1 cordless impact wrench/driver, 2 battery packs (Li-ion), 1 rapid charger ALG 50, 1 belt clip, 1 bit holder, 1 plastic carrying case

**ASCD 18-200 W4 Select**

Impact wrench/driver with brushless motor and 6-stage torque setting. For universal screwdriving applications including self-drilling screwdriving.

**New 2017**  
**FEIN SELECT+**

For accessories, see page 26

Battery voltage	V	18
Motor		brushless
Speed, no load	1/min	0 - 1 500
Impacts	1/min	0 - 3 000
Max. torque	Nm	210
Torque levels		6
Tool Holder		1/4" hexagon socket
Wood screw Ø	mm	8 x 200
Weight without storage battery	kg	1
<b>Part number</b>		<b>7 115 07 64 00 0</b>
<b>EAN</b>		<b>4014586887449</b>
<b>Price in € [PC18]</b>		<b>250,95</b>

**FEIN benefits:**

- ▶ Brushless FEIN PowerDrive motor with 30% higher efficiency and long service life.
- ▶ Electronic 6-stage torque setting prevents screw heads from being torn off.
- ▶ 10% more torque in reverse running to loosen screws which are extremely tight.
- ▶ MultiVolt interface. Cordless tool can be operated with all FEIN Li-ion batteries (12-18 V).
- ▶ 1/4" hexagon socket for holding bits and socket wrench inserts.
- ▶ Robust solid metal impact gear.
- ▶ Contact guard on gearbox head.
- ▶ Compact design.
- ▶ One charger for all FEIN Li-ion batteries of all voltage classes.
- ▶ The battery charge can be read off the battery.
- ▶ FEIN SafetyCell technology. Protects the battery and tool from overload, overheating and total discharge.
- ▶ 3-year FEIN warranty including battery and charger.

**Price includes:**

1 cordless impact wrench/driver, 1 belt clip, 1 bit holder, 1 plastic carrying case

**ASCD 12-150 W8C**

Cordless impact wrench/driver with brushless motor and 6-stage torque setting. For metric screwdriving applications up to M14.

**New 2017**

For accessories, see page 26

Battery voltage	V	12
Battery capacity	Ah	2,5
Motor		brushless
Speed, no load	1/min	0 - 1 800
Impacts	1/min	0 - 3 600
Max. torque	Nm	135
Torque levels		6
Tool Holder		3/8" Outer square
Max. metric screw		M14 (8.8)
Wood screw Ø	mm	8 x 100
Weight with battery	kg	1,1
Weight without storage battery	kg	0,85
<b>Part number</b>		<b>7 115 04 61 00 0</b>
<b>EAN</b>		<b>4014586887371</b>
<b>Price in € [PC18]</b>		<b>271,95</b>

**FEIN benefits:**

- ▶ Brushless FEIN PowerDrive motor with 30% higher efficiency and long service life.
- ▶ Electronic 6-stage torque setting prevents screw heads from being torn off.
- ▶ 10% more torque in reverse running to loosen screws which are extremely tight.
- ▶ 3/8" square for holding sockets.
- ▶ Robust solid metal impact gear.
- ▶ Metric screws up to M14 (8.8).
- ▶ Contact guard on gearbox head.
- ▶ Can be set down safely on the battery.
- ▶ Slim handle.
- ▶ Compact design.
- ▶ One charger for all FEIN Li-ion batteries of all voltage classes.
- ▶ The battery charge can be read off the battery.
- ▶ FEIN SafetyCell technology. Protects the battery and tool from overload, overheating and total discharge.
- ▶ 3-year FEIN PLUS warranty including battery and charger.

**Price includes:**

1 cordless impact wrench/driver, 2 battery packs (Li-ion), 1 rapid charger ALG 50, 1 belt clip, 1 bit holder, 1 plastic carrying case

**ASCD 12-150 W8 Select**

Cordless impact wrench/driver with brushless motor and 6-stage torque setting. For metric screwdriving applications up to M14.

**New 2017**  
**FEIN SELECT+**

For accessories, see page 26

Battery voltage	V	12
Motor		brushless
Speed, no load	1/min	0 - 1 800
Impacts	1/min	0 - 3 600
Max. torque	Nm	135
Torque levels		6
Tool Holder		3/8" Outer square
Max. metric screw		M14 (8.8)
Wood screw Ø	mm	8 x 100
Weight without storage battery	kg	0,85
<b>Part number</b>		<b>7 115 04 64 00 0</b>
<b>EAN</b>		<b>4014586887388</b>
<b>Price in € [PC18]</b>		<b>170,10</b>

**FEIN benefits:**

- ▶ Brushless FEIN PowerDrive motor with 30% higher efficiency and long service life.
- ▶ Electronic 6-stage torque setting prevents screw heads from being torn off.
- ▶ 10% more torque in reverse running to loosen screws which are extremely tight.
- ▶ 3/8" square for holding sockets.
- ▶ Robust solid metal impact gear.
- ▶ Metric screws up to M14 (8.8).
- ▶ Contact guard on gearbox head.
- ▶ Can be set down safely on the battery.
- ▶ Slim handle.
- ▶ Compact design.
- ▶ One charger for all FEIN Li-ion batteries of all voltage classes.
- ▶ The battery charge can be read off the battery.
- ▶ FEIN SafetyCell technology. Protects the battery and tool from overload, overheating and total discharge.
- ▶ 3-year FEIN PLUS warranty including battery and charger.

**Price includes:**

1 cordless impact wrench/driver, 1 belt clip, 1 bit holder, 1 plastic carrying case

**ASCD 12-150 W4C**



For accessories, see page 26

Impact wrench/driver with brushless motor and 6-stage torque setting. For universal screwdriving applications including self-drilling screwdriving.

Battery voltage	V	12
Battery capacity	Ah	2,5
Motor		brushless
Speed, no load	1/min	0 - 1 700
Impacts	1/min	0 - 3 400
Max. torque	Nm	135
Torque levels		6
Tool Holder		1/4" hexagon socket
Wood screw Ø	mm	8 x 100
Weight with battery	kg	1,1
Weight without storage battery	kg	0,85
<b>Part number</b>		<b>7 115 05 61 00 0</b>
<b>EAN</b>		<b>4014586887395</b>
<b>Price in € [PC18]</b>		<b>261,45</b>

**FEIN benefits:**

- ▶ Brushless FEIN PowerDrive motor with 30% higher efficiency and long service life.
- ▶ Electronic 6-stage torque setting prevents screw heads from being torn off.
- ▶ 10% more torque in reverse running to loosen screws which are extremely tight.
- ▶ 1/4" hexagon socket for holding bits and socket wrench inserts.
- ▶ Robust solid metal impact gear.
- ▶ Contact guard on gearbox head.
- ▶ Can be set down safely on the battery.
- ▶ Slim handle.
- ▶ Compact design.
- ▶ One charger for all FEIN Li-ion batteries of all voltage classes.
- ▶ The battery charge can be read off the battery.
- ▶ FEIN SafetyCell technology. Protects the battery and tool from overload, overheating and total discharge.
- ▶ 3-year FEIN PLUS warranty including battery and charger.

**Price includes:**

1 cordless impact wrench/driver, 2 battery packs (Li-ion), 1 rapid charger ALG 50, 1 belt clip, 1 bit holder, 1 plastic carrying case

**ASCD 12-150 W4 Select**



For accessories, see page 26

Impact wrench/driver with brushless motor and 6-stage torque setting. For universal screwdriving applications including self-drilling screwdriving.

Battery voltage	V	12
Motor		brushless
Speed, no load	1/min	0 - 1 700
Impacts	1/min	0 - 3 400
Max. torque	Nm	135
Torque levels		6
Tool Holder		1/4" hexagon socket
Wood screw Ø	mm	8 x 100
Weight without storage battery	kg	0,85
<b>Part number</b>		<b>7 115 05 64 00 0</b>
<b>EAN</b>		<b>4014586887401</b>
<b>Price in € [PC18]</b>		<b>159,60</b>

**FEIN benefits:**

- ▶ Brushless FEIN PowerDrive motor with 30% higher efficiency and long service life.
- ▶ Electronic 6-stage torque setting prevents screw heads from being torn off.
- ▶ 10% more torque in reverse running to loosen screws which are extremely tight.
- ▶ 1/4" hexagon socket for holding bits and socket wrench inserts.
- ▶ Robust solid metal impact gear.
- ▶ Contact guard on gearbox head.
- ▶ Can be set down safely on the battery.
- ▶ Slim handle.
- ▶ Compact design.
- ▶ One charger for all FEIN Li-ion batteries of all voltage classes.
- ▶ The battery charge can be read off the battery.
- ▶ FEIN SafetyCell technology. Protects the battery and tool from overload, overheating and total discharge.
- ▶ 3-year FEIN PLUS warranty including battery and charger.

**Price includes:**

1 cordless impact wrench/driver, 1 belt clip, 1 bit holder, 1 plastic carrying case

**ASCD 12-100 W4C**

Cordless impact wrench/driver with DC motor. For universal screw connections.



For accessories, see page 26

Battery voltage	V	12
Battery capacity	Ah	2,5
Motor		2-pole DC
Speed, no load	1/min	0 - 2 700
Impacts	1/min	0 - 3 450
Max. torque	Nm	100
Tool Holder		1/4" hexagon socket
Fastening		8 mm / M14
Wood screw Ø	mm	8 x 80
Weight with battery	kg	1,1
Weight without storage battery	kg	0,9
<b>Part number</b>		<b>7 115 03 61 00 0</b>
<b>EAN</b>		<b>4014586881560</b>
<b>Price in € [PC18]</b>		<b>229,95</b>

**FEIN benefits:**

- ▶ Powerful and long-life DC motor with overheating and overload protection.
- ▶ Up to 100 Nm torque - tightens screws of up to M12 with ease.
- ▶ 1/4" hexagon socket for holding bits and socket wrench inserts.
- ▶ Robust solid metal impact gear.
- ▶ Aluminium gearbox housing.
- ▶ Can be set down safely on the battery.
- ▶ Slim handle.
- ▶ One charger for all FEIN Li-ion batteries of all voltage classes.
- ▶ The battery charge can be read off the battery.
- ▶ FEIN SafetyCell technology. Protects the battery and tool from overload, overheating and total discharge.
- ▶ 3-year FEIN PLUS warranty including battery and charger.

**Price includes:**

1 cordless impact wrench/driver, 2 battery packs (Li-ion), 1 rapid charger ALG 50, 1 belt clip, 1 bit holder, 1 plastic carrying case

**ASCD 12-100 W4 Select**

Cordless impact wrench/driver with DC motor. For universal screw connections.

**FEIN SELECT<sup>+</sup>**

For accessories, see page 26

Battery voltage	V	12
Motor		2-pole DC
Speed, no load	1/min	0 - 2 700
Impacts	1/min	0 - 3 450
Max. torque	Nm	100
Tool Holder		1/4" hexagon socket
Fastening		8 mm / M14
Wood screw Ø	mm	8 x 80
Weight without storage battery	kg	0,9
<b>Part number</b>		<b>7 115 03 64 00 0</b>
<b>EAN</b>		<b>4014586885582</b>
<b>Price in € [PC18]</b>		<b>128,10</b>

**FEIN benefits:**

- ▶ Powerful and long-life DC motor with overheating and overload protection.
- ▶ Up to 100 Nm torque - tightens screws of up to M12 with ease.
- ▶ 1/4" hexagon socket for holding bits and socket wrench inserts.
- ▶ Robust solid metal impact gear.
- ▶ Aluminium gearbox housing.
- ▶ Can be set down safely on the battery.
- ▶ Slim handle.
- ▶ One charger for all FEIN Li-ion batteries of all voltage classes.
- ▶ The battery charge can be read off the battery.
- ▶ FEIN SafetyCell technology. Protects the battery and tool from overload, overheating and total discharge.
- ▶ 3-year FEIN PLUS warranty including battery and charger.

**Price includes:**

1 cordless impact wrench/driver, 1 belt clip, 1 bit holder, 1 plastic carrying case



**General accessories**



**Cordless ALED 12-18 V LED lamp**

Compact and durable cordless LED lamp with swivel-mounted lamp head. Compatible with all 12 / 14 / 18 V FEIN Li-ion batteries, including hook for attaching the lamp. Extremely lightweight at 130 g and very bright at 900 Lux. Colour temperature is the equivalent of daylight. The brightness can be set to 2 levels.

Part number	Price in €
9 26 04 200 02 0	52,50



**Tool case**

Plastic, inner dimensions: 470 x 275 x 116 mm

Part number	Price in €
3 39 01 118 01 0	37,26



**Tool case**

Suitable for ABSU 12, ASCD 12, ASCM 12

Part number	Price in €
3 39 01 160 01 0	22,13



**Plastic box**

Box insert with lockable lid for small parts and accessories, suitable for tool box 3 39 01 118 01 0, max 5 items/box.

Part number	Price in €
3 39 01 119 00 0	3,97



**Quick charger ALG 50**

For all FEIN Li-ion batteries. Charge time from 35 min.

Part number	Price in €
9 26 04 129 01 0	40,95



**Quick charger ALG 30**

For FEIN NiCd and Li-ion batteries. Charge time from 25 min.

Part number	Price in €
9 26 04 096 01 0	142,80

**18 V battery**



**Battery pack**

Li-ion with charge status indicator and FEIN SafetyCell Technology. Protects the battery and tool from overload, overheating and total discharge.

Current/Voltages	Capacity	Part number	Price in €
V	Ah		
18	5	9 26 04 173 02 0	103,95
18	2,5	9 26 04 171 02 0	72,45

**12 V battery**



**Battery pack**

Li-ion with charge status indicator and FEIN SafetyCell Technology. Protects the battery and tool from overload, overheating and total discharge.

Current/Voltages	Capacity	Part number	Price in €
V	Ah		
12	2,5	9 26 04 168 02 0	30,45



**Battery starter set**

Very durable, light 12 V Li-ion batteries with innovative SafetyCell technology, 2,5 Ah capacity and charge indicator.

Part number	Price in €
9 26 04 250 01 0	101,85



	ASM 14-2 (without battery)	ASM 14-6 (without battery)	ASM 14-9 (without battery)	ASM 14-12 (without battery)	ASM 14-2 PC (without battery)	ASM 14-6 PC (without battery)	ASM 14-9 PC (without battery)	ASM 14-12 PC (without battery)
	Certified screwdriver according to ISO 5393, VDI/VDE 2647, achieves CMK value > 1,67 at ± 12% (referred to 6 Sigma).	Certified screwdriver according to ISO 5393, VDI/VDE 2647, achieves CMK value > 1,67 at ± 10% (referred to 6 Sigma).			Programmable screwdrivers, tested for compliance with ISO 5393, VDI/VDE 2647, achieves CMK value > 1,67 at ± 12% (referred to 6 Sigma).	Programmable screwdrivers, tested for compliance with ISO 5393, VDI/VDE 2647, achieves CMK value > 1,67 at ± 10% (referred to 6 Sigma).		
<b>Page</b>	28	28	28	28	29	29	29	29
<b>Technical features</b>	Battery voltage	14,4 V	14,4 V	14,4 V	14,4 V	14,4 V	14,4 V	14,4 V
	Torque range	0,7 - 2 Nm	1,2 - 6 Nm	2 - 9 Nm	3 - 12 Nm	0,7 - 2 Nm	1,2 - 6 Nm	2 - 9 Nm
	Speed, no load	350 1/min	600 1/min	600 1/min	500 1/min	50 - 700 1/min	50 - 950 1/min	50 - 700 1/min
	Tool Holder	1/4" hexagon socket	1/4" hexagon socket	1/4" hexagon socket	1/4" hexagon socket	1/4" hexagon socket	1/4" hexagon socket	1/4" hexagon socket
	Weight without storage battery	0,95 kg	0,95 kg	0,95 kg	0,95 kg	0,95 kg	0,95 kg	0,95 kg

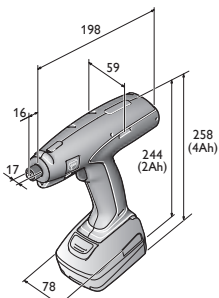

- ASM 14-2
- ASM 14-2 PC
- ASM 14-6
- ASM 14-6 PC
- ASM 14-9
- ASM 14-9 PC
- ASM 14-12
- ASM 14-12 PC

**ASM 14-2 (without battery)**

Certified screwdriver according to ISO 5393, VDI/VDE 2647, achieves CMK value > 1,67 at ± 12% (referred to 6 Sigma).



For accessories, see page 34

Battery voltage	V	14,4
Torque range	Nm	0,7 - 2
Speed, no load	1/min	350
Tool Holder		1/4" hexagon socket
Weight without storage battery	kg	0,95
<b>Part number</b>		<b>7 112 60 00 95 0</b>
<b>EAN</b>		<b>4014586881294</b>
<b>Price in € [PC05]</b>		<b>523,95</b>

**FEIN benefits:**

- ▶ Brushless, maintenance-free motor.
- ▶ Process-optimised thanks to switch-on delay and restart lock (battery monitoring).
- ▶ Consistently precise tightening torque regardless of screwdriving operation.
- ▶ Reverse direction activated at the touch of a button.
- ▶ FEIN Li-ion technology for more screw connections per battery charge.
- ▶ Constant speed right up to switch-off.
- ▶ Continuous illumination of the screwdriving site.
- ▶ For soft and hard screwed connections.
- ▶ Soft start.
- ▶ Soft cut-out.

**ASM 14-6 (without battery)**

Certified screwdriver according to ISO 5393, VDI/VDE 2647, achieves CMK value > 1,67 at ± 10% (referred to 6 Sigma).



For accessories, see page 34

Battery voltage	V	14,4
Torque range	Nm	1,2 - 6
Speed, no load	1/min	600
Tool Holder		1/4" hexagon socket
Weight without storage battery	kg	0,95
<b>Part number</b>		<b>7 112 28 00 95 0</b>
<b>EAN</b>		<b>4014586876238</b>
<b>Price in € [PC05]</b>		<b>523,95</b>

**FEIN benefits:**

- ▶ Brushless, maintenance-free motor.
- ▶ Consistently precise tightening torque regardless of screwdriving operation.
- ▶ Process-optimised thanks to switch-on delay and restart lock (battery monitoring).
- ▶ Reverse direction activated at the touch of a button.
- ▶ FEIN Li-ion technology for more screw connections per battery charge.
- ▶ Constant speed right up to switch-off.
- ▶ Continuous illumination of the screwdriving site.
- ▶ For soft and hard screwed connections.
- ▶ Soft start.
- ▶ Soft cut-out.

**ASM 14-9 (without battery)**

Certified screwdriver according to ISO 5393, VDI/VDE 2647, achieves CMK value > 1,67 at ± 10% (referred to 6 Sigma).



For accessories, see page 34

Battery voltage	V	14,4
Torque range	Nm	2 - 9
Speed, no load	1/min	600
Tool Holder		1/4" hexagon socket
Weight without storage battery	kg	0,95
<b>Part number</b>		<b>7 112 59 00 95 0</b>
<b>EAN</b>		<b>4014586877211</b>
<b>Price in € [PC05]</b>		<b>523,95</b>

**FEIN benefits:**

- ▶ Brushless, maintenance-free motor.
- ▶ Consistently precise tightening torque regardless of screwdriving operation.
- ▶ Process-optimised thanks to switch-on delay and restart lock (battery monitoring).
- ▶ Reverse direction activated at the touch of a button.
- ▶ FEIN Li-ion technology for more screw connections per battery charge.
- ▶ Constant speed right up to switch-off.
- ▶ Continuous illumination of the screwdriving site.
- ▶ For soft and hard screwed connections.
- ▶ Soft start.
- ▶ Soft cut-out.

**ASM 14-12 (without battery)**

Certified screwdriver according to ISO 5393, VDI/VDE 2647, achieves CMK value > 1,67 at ± 10% (referred to 6 Sigma).



For accessories, see page 34

Battery voltage	V	14,4
Torque range	Nm	3 - 12
Speed, no load	1/min	500
Tool Holder		1/4" hexagon socket
Weight without storage battery	kg	0,95
<b>Part number</b>		<b>7 112 57 00 95 0</b>
<b>EAN</b>		<b>4014586877198</b>
<b>Price in € [PC05]</b>		<b>523,95</b>

**FEIN benefits:**

- ▶ Brushless, maintenance-free motor.
- ▶ Consistently precise tightening torque regardless of screwdriving operation.
- ▶ Process-optimised thanks to switch-on delay and restart lock (battery monitoring).
- ▶ Reverse direction activated at the touch of a button.
- ▶ FEIN Li-ion technology for more screw connections per battery charge.
- ▶ Constant speed right up to switch-off.
- ▶ Continuous illumination of the screwdriving site.
- ▶ For soft and hard screwed connections.
- ▶ Soft start.
- ▶ Soft cut-out.

**ASM 14-2 PC (without battery)**

Programmable screwdrivers, tested for compliance with ISO 5393, VDI/VDE 2647, achieves CMK value &gt; 1,67 at ± 12% (referred to 6 Sigma).



For accessories, see page 34

Battery voltage	V	14,4
Torque range	Nm	0,7 - 2
Speed, no load	1/min	50 - 700
Tool Holder		1/4" hexagon socket
Weight without storage battery	kg	0,95
<b>Part number</b>		<b>7 112 61 00 95 0</b>
<b>EAN</b>		<b>4014586881317</b>
<b>Price in € [PC05]</b>		<b>681,45</b>

**FEIN benefits:**

- ▶ Brushless, maintenance-free motor.
- ▶ Freely programmable parameters: speed, direction of rotation, angle of rotation, torque, threshold, time.
- ▶ Can be adapted to the individual application in up to seven program steps to suit your process.
- ▶ Parameters can be set for both clockwise and anti-clockwise operation.
- ▶ Adjustable error criteria prevent manipulation.
- ▶ FEIN Li-ion technology for more screw connections per battery charge.
- ▶ Maintenance module records all screw connections and calibration data.
- ▶ Easy data input on the computer.
- ▶ Program with confidence using the integrated interface.
- ▶ Store data for later reuse.
- ▶ For soft and hard screwed connections.
- ▶ Sensor-based control means no loss of speed when screwdriving.
- ▶ Protection of the tool through a factory-installed password.

**ASM 14-6 PC (without battery)**

Programmable screwdrivers, tested for compliance with ISO 5393, VDI/VDE 2647, achieves CMK value &gt; 1,67 at ± 10% (referred to 6 Sigma).



For accessories, see page 34

Battery voltage	V	14,4
Torque range	Nm	1,2 - 6
Speed, no load	1/min	50 - 950
Tool Holder		1/4" hexagon socket
Weight without storage battery	kg	0,95
<b>Part number</b>		<b>7 112 54 00 95 0</b>
<b>EAN</b>		<b>4014586874241</b>
<b>Price in € [PC05]</b>		<b>681,45</b>

**FEIN benefits:**

- ▶ Brushless, maintenance-free motor.
- ▶ Freely programmable parameters: speed, direction of rotation, angle of rotation, torque, threshold, time.
- ▶ Can be adapted to the individual application in up to seven program steps to suit your process.
- ▶ Parameters can be set for both clockwise and anti-clockwise operation.
- ▶ Adjustable error criteria prevent manipulation.
- ▶ FEIN Li-ion technology for more screw connections per battery charge.
- ▶ Maintenance module records all screw connections and calibration data.
- ▶ Easy data input on the computer.
- ▶ Program with confidence using the integrated interface.
- ▶ Store data for later reuse.
- ▶ For soft and hard screwed connections.
- ▶ Sensor-based control means no loss of speed when screwdriving.
- ▶ Protection of the tool through a factory-installed password.

**ASM 14-9 PC (without battery)**

Programmable screwdrivers, tested for compliance with ISO 5393, VDI/VDE 2647, achieves CMK value &gt; 1,67 at ± 10% (referred to 6 Sigma).



For accessories, see page 34

Battery voltage	V	14,4
Torque range	Nm	2 - 9
Speed, no load	1/min	50 - 700
Tool Holder		1/4" hexagon socket
Weight without storage battery	kg	0,95
<b>Part number</b>		<b>7 112 55 00 95 0</b>
<b>EAN</b>		<b>4014586874258</b>
<b>Price in € [PC05]</b>		<b>681,45</b>

**FEIN benefits:**

- ▶ Brushless, maintenance-free motor.
- ▶ Freely programmable parameters: speed, direction of rotation, angle of rotation, torque, threshold, time.
- ▶ Can be adapted to the individual application in up to seven program steps to suit your process.
- ▶ Parameters can be set for both clockwise and anti-clockwise operation.
- ▶ Adjustable error criteria prevent manipulation.
- ▶ FEIN Li-ion technology for more screw connections per battery charge.
- ▶ Maintenance module records all screw connections and calibration data.
- ▶ Easy data input on the computer.
- ▶ Program with confidence using the integrated interface.
- ▶ Store data for later reuse.
- ▶ For soft and hard screwed connections.
- ▶ Sensor-based control means no loss of speed when screwdriving.
- ▶ Protection of the tool through a factory-installed password.

**ASM 14-12 PC (without battery)**

Programmable screwdrivers, tested for compliance with ISO 5393, VDI/VDE 2647, achieves CMK value &gt; 1,67 at ± 10% (referred to 6 Sigma).



For accessories, see page 34

Battery voltage	V	14,4
Torque range	Nm	3 - 12
Speed, no load	1/min	50 - 700
Tool Holder		1/4" hexagon socket
Weight without storage battery	kg	0,95
<b>Part number</b>		<b>7 112 56 00 95 0</b>
<b>EAN</b>		<b>4014586874265</b>
<b>Price in € [PC05]</b>		<b>681,45</b>

**FEIN benefits:**

- ▶ Brushless, maintenance-free motor.
- ▶ Freely programmable parameters: speed, direction of rotation, angle of rotation, torque, threshold, time.
- ▶ Can be adapted to the individual application in up to seven program steps to suit your process.
- ▶ Parameters can be set for both clockwise and anti-clockwise operation.
- ▶ Adjustable error criteria prevent manipulation.
- ▶ FEIN Li-ion technology for more screw connections per battery charge.
- ▶ Maintenance module records all screw connections and calibration data.
- ▶ Easy data input on the computer.
- ▶ Program with confidence using the integrated interface.
- ▶ Store data for later reuse.
- ▶ For soft and hard screwed connections.
- ▶ Sensor-based control means no loss of speed when screwdriving.
- ▶ Protection of the tool through a factory-installed password.



	ASW 14-6 (without battery and angled head)	ASW 14-10 (without battery and angled head)	ASW 14-14 (without battery and angled head)	ASW 14-6 PC (without battery and angled head)	ASW 14-10 PC (without battery and angled head)	ASW 14-14 PC (without battery and angled head)	ASW 18-30 PC (without battery and angled head)	ASW 18-45 PC (without battery and angled head)	ASW 18-60 PC (without battery and angled head)
	Certified screwdriver according to ISO 5393, VDI/VDE 2647, achieves CMK value > 1,67 at ± 10% (referred to 6 Sigma).			Programmable screwdrivers, tested for compliance with ISO 5393, VDI/VDE 2647, achieves CMK value > 1,67 at ± 10% (referred to 6 Sigma).					
<b>Page</b>	31	31	31	32	32	32	33	33	33
<b>Technical features</b>									
Battery voltage	14,4 V	14,4 V	14,4 V	14,4 V	14,4 V	14,4 V	18 V	18 V	18 V
Torque range	1,5 - 6 Nm	2 - 10 Nm	3 - 14 Nm	1,5 - 6 Nm	2 - 10 Nm	3 - 14 Nm	12 - 30 Nm	20 - 45 Nm	25 - 60 Nm
Speed, no load	650 1/min	500 1/min	400 1/min	50 - 670 1/min	50 - 670 1/min	50 - 670 1/min	30 - 420 1/min	25 - 310 1/min	20 - 230 1/min
Weight without storage battery	0,9 kg	0,9 kg	0,9 kg	0,9 kg	0,9 kg	0,9 kg	1,2 kg	1,2 kg	1,2 kg

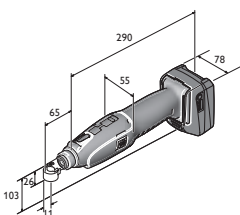

ASW 14-6  
ASW 14-6 PC  
ASW 14-10  
ASW 14-10 PC  
ASW 14-14  
ASW 14-14 PC

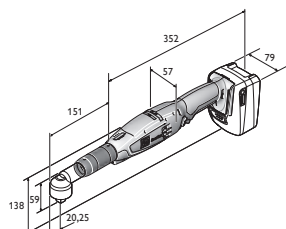

ASW 18-30 PC  
ASW 18-45 PC  
ASW 18-60 PC





**ASW 14-6**  
(without battery and angled head)

Certified screwdriver according to ISO 5393, VDI/VDE 2647, achieves CMK value > 1,67 at ± 10% (referred to 6 Sigma).



Battery voltage	V	14,4
Torque range	Nm	1,5 - 6
Speed, no load	1/min	650
Weight without storage battery	kg	0,9
<b>Part number</b>	<b>7 112 40 00 95 0</b>	
<b>EAN</b>	<b>4014586876245</b>	
<b>Price in € [PC05]</b>	<b>523,95</b>	

**FEIN benefits:**

- ▶ Brushless, maintenance-free motor.
- ▶ Consistently precise tightening torque regardless of screwdriving operation.
- ▶ Process-optimised thanks to switch-on delay and restart lock (battery monitoring).
- ▶ Reverse direction activated at the touch of a button.
- ▶ FEIN Li-ion technology for more screw connections per battery charge.
- ▶ Constant speed right up to switch-off.
- ▶ Continuous illumination of the screwdriving site.
- ▶ For soft and hard screwed connections.
- ▶ Soft start.
- ▶ Soft cut-out.
- ▶ Very high operating efficiency.
- ▶ Angled heads can be adjusted by 360°.
- ▶ Tongue tools can be used.

For accessories, see page 34

**ASW 14-10**  
(without battery and angled head)

Certified screwdriver according to ISO 5393, VDI/VDE 2647, achieves CMK value > 1,67 at ± 10% (referred to 6 Sigma).



Battery voltage	V	14,4
Torque range	Nm	2 - 10
Speed, no load	1/min	500
Weight without storage battery	kg	0,9
<b>Part number</b>	<b>7 112 42 00 95 0</b>	
<b>EAN</b>	<b>4014586876252</b>	
<b>Price in € [PC05]</b>	<b>523,95</b>	

**FEIN benefits:**

- ▶ Brushless, maintenance-free motor.
- ▶ Consistently precise tightening torque regardless of screwdriving operation.
- ▶ Process-optimised thanks to switch-on delay and restart lock (battery monitoring).
- ▶ Reverse direction activated at the touch of a button.
- ▶ FEIN Li-ion technology for more screw connections per battery charge.
- ▶ Constant speed right up to switch-off.
- ▶ Continuous illumination of the screwdriving site.
- ▶ For soft and hard screwed connections.
- ▶ Soft start.
- ▶ Soft cut-out.
- ▶ Very high operating efficiency.
- ▶ Angled heads can be adjusted by 360°.
- ▶ Tongue tools can be used.

For accessories, see page 34

**ASW 14-14**  
(without battery and angled head)

Certified screwdriver according to ISO 5393, VDI/VDE 2647, achieves CMK value > 1,67 at ± 10% (referred to 6 Sigma).



Battery voltage	V	14,4
Torque range	Nm	3 - 14
Speed, no load	1/min	400
Weight without storage battery	kg	0,9
<b>Part number</b>	<b>7 112 58 00 95 0</b>	
<b>EAN</b>	<b>4014586877204</b>	
<b>Price in € [PC05]</b>	<b>523,95</b>	

**FEIN benefits:**

- ▶ Brushless, maintenance-free motor.
- ▶ Consistently precise tightening torque regardless of screwdriving operation.
- ▶ Process-optimised thanks to switch-on delay and restart lock (battery monitoring).
- ▶ Reverse direction activated at the touch of a button.
- ▶ FEIN Li-ion technology for more screw connections per battery charge.
- ▶ Constant speed right up to switch-off.
- ▶ Continuous illumination of the screwdriving site.
- ▶ For soft and hard screwed connections.
- ▶ Soft start.
- ▶ Soft cut-out.
- ▶ Very high operating efficiency.
- ▶ Angled heads can be adjusted by 360°.
- ▶ Tongue tools can be used.

For accessories, see page 34

**ASW 14-6 PC**  
(without battery and angled head)

Programmable screwdrivers, tested for compliance with ISO 5393, VDI/VDE 2647, achieves CMK value > 1,67 at ± 10% (referred to 6 Sigma).



For accessories, see page 34

Battery voltage	V	14,4
Torque range	Nm	1,5 - 6
Speed, no load	1/min	50 - 670
Weight without storage battery	kg	0,9
<b>Part number</b>		<b>7 112 50 00 95 0</b>
<b>EAN</b>		<b>4014586874210</b>
<b>Price in € [PC05]</b>		<b>699,30</b>

**FEIN benefits:**

- ▶ Can be adapted to the individual application in up to seven program steps to suit your process.
- ▶ Freely programmable parameters: speed, direction of rotation, angle of rotation, torque, threshold, time.
- ▶ Brushless, maintenance-free motor.
- ▶ Parameters can be set for both clockwise and anti-clockwise operation.
- ▶ Adjustable error criteria prevent manipulation.
- ▶ FEIN Li-ion technology for more screw connections per battery charge.
- ▶ Maintenance module records all screw connections and calibration data.
- ▶ Easy data input on the computer.
- ▶ Program with confidence using the integrated interface.
- ▶ Store data for later reuse.
- ▶ For soft and hard screwed connections.
- ▶ Sensor-based control means no loss of speed when screwdriving.
- ▶ Protection of the tool through a factory-installed password.
- ▶ Powerful lithium ion battery with capacity display.
- ▶ Angled heads can be adjusted by 360°.
- ▶ Tongue tools can be used.

**ASW 14-10 PC**  
(without battery and angled head)

Programmable screwdrivers, tested for compliance with ISO 5393, VDI/VDE 2647, achieves CMK value > 1,67 at ± 10% (referred to 6 Sigma).



For accessories, see page 34

Battery voltage	V	14,4
Torque range	Nm	2 - 10
Speed, no load	1/min	50 - 670
Weight without storage battery	kg	0,9
<b>Part number</b>		<b>7 112 51 00 95 0</b>
<b>EAN</b>		<b>4014586874227</b>
<b>Price in € [PC05]</b>		<b>699,30</b>

**FEIN benefits:**

- ▶ Can be adapted to the individual application in up to seven program steps to suit your process.
- ▶ Freely programmable parameters: speed, direction of rotation, angle of rotation, torque, threshold, time.
- ▶ Brushless, maintenance-free motor.
- ▶ Parameters can be set for both clockwise and anti-clockwise operation.
- ▶ Adjustable error criteria prevent manipulation.
- ▶ FEIN Li-ion technology for more screw connections per battery charge.
- ▶ Maintenance module records all screw connections and calibration data.
- ▶ Easy data input on the computer.
- ▶ Program with confidence using the integrated interface.
- ▶ Store data for later reuse.
- ▶ For soft and hard screwed connections.
- ▶ Sensor-based control means no loss of speed when screwdriving.
- ▶ Protection of the tool through a factory-installed password.
- ▶ Powerful lithium ion battery with capacity display.
- ▶ Angled heads can be adjusted by 360°.
- ▶ Tongue tools can be used.

**ASW 14-14 PC**  
(without battery and angled head)

Programmable screwdrivers, tested for compliance with ISO 5393, VDI/VDE 2647, achieves CMK value > 1,67 at ± 10% (referred to 6 Sigma).



For accessories, see page 34

Battery voltage	V	14,4
Torque range	Nm	3 - 14
Speed, no load	1/min	50 - 500
Weight without storage battery	kg	0,9
<b>Part number</b>		<b>7 112 52 00 95 0</b>
<b>EAN</b>		<b>4014586874234</b>
<b>Price in € [PC05]</b>		<b>699,30</b>

**FEIN benefits:**

- ▶ Brushless, maintenance-free motor.
- ▶ Freely programmable parameters: speed, direction of rotation, angle of rotation, torque, threshold, time.
- ▶ Can be adapted to the individual application in up to seven program steps to suit your process.
- ▶ Parameters can be set for both clockwise and anti-clockwise operation.
- ▶ Adjustable error criteria prevent manipulation.
- ▶ FEIN Li-ion technology for more screw connections per battery charge.
- ▶ Maintenance module records all screw connections and calibration data.
- ▶ Easy data input on the computer.
- ▶ Program with confidence using the integrated interface.
- ▶ Store data for later reuse.
- ▶ For soft and hard screwed connections.
- ▶ Sensor-based control means no loss of speed when screwdriving.
- ▶ Protection of the tool through a factory-installed password.
- ▶ Powerful lithium ion battery with capacity display.
- ▶ Angled heads can be adjusted by 360°.
- ▶ Tongue tools can be used.

**ASW 18-30 PC**  
(without battery and angled head)

Programmable screwdrivers, tested for compliance with ISO 5393, VDI/VDE 2647, achieves CMK value &gt; 1,67 at ± 10% (referred to 6 Sigma).



For accessories, see page 34

Battery voltage	V	18
Torque range	Nm	12 - 30
Speed, no load	1/min	30 - 420
Weight without storage battery	kg	1,2
<b>Part number</b>		<b>7 112 62 60 00 0</b>
<b>EAN</b>		<b>4014586883830</b>
<b>Price in € [PC05]</b>		<b>1.102,50</b>

**FEIN benefits:**

- ▶ Brushless, maintenance-free motor.
- ▶ Programmable fuel gauge on the tool.
- ▶ Freely programmable parameters: speed, direction of rotation, angle of rotation, torque, threshold, time.
- ▶ Parameters can be set for both clockwise and anti-clockwise operation.
- ▶ Can be adapted to the individual application in up to five program steps to suit your process.
- ▶ FEIN Li-ion technology for more screw connections per battery charge.
- ▶ Maintenance module records all screw connections and calibration data.
- ▶ Easy data input on the computer.
- ▶ Store data for later reuse.
- ▶ For soft and hard screwed connections.
- ▶ Sensor-based control means no loss of speed when screwdriving.
- ▶ Protection of the tool through a factory-installed password.
- ▶ Powerful lithium ion battery with capacity display.
- ▶ Angled head can be set in 30° steps.
- ▶ Tongue tools can be used.

**ASW 18-45 PC**  
(without battery and angled head)

Programmable screwdrivers, tested for compliance with ISO 5393, VDI/VDE 2647, achieves CMK value &gt; 1,67 at ± 10% (referred to 6 Sigma).



For accessories, see page 34

Battery voltage	V	18
Torque range	Nm	20 - 45
Speed, no load	1/min	25 - 310
Weight without storage battery	kg	1,2
<b>Part number</b>		<b>7 112 63 60 00 0</b>
<b>EAN</b>		<b>4014586883847</b>
<b>Price in € [PC05]</b>		<b>1.155,00</b>

**FEIN benefits:**

- ▶ Brushless, maintenance-free motor.
- ▶ Programmable fuel gauge on the tool.
- ▶ Freely programmable parameters: speed, direction of rotation, angle of rotation, torque, threshold, time.
- ▶ Parameters can be set for both clockwise and anti-clockwise operation.
- ▶ Can be adapted to the individual application in up to five program steps to suit your process.
- ▶ FEIN Li-ion technology for more screw connections per battery charge.
- ▶ Maintenance module records all screw connections and calibration data.
- ▶ Easy data input on the computer.
- ▶ Store data for later reuse.
- ▶ For soft and hard screwed connections.
- ▶ Sensor-based control means no loss of speed when screwdriving.
- ▶ Protection of the tool through a factory-installed password.
- ▶ Powerful lithium ion battery with capacity display.
- ▶ Angled head can be set in 30° steps.
- ▶ Tongue tools can be used.

**ASW 18-60 PC**  
(without battery and angled head)

Programmable screwdrivers, tested for compliance with ISO 5393, VDI/VDE 2647, achieves CMK value &gt; 1,67 at ± 10% (referred to 6 Sigma).



For accessories, see page 34

Battery voltage	V	18
Torque range	Nm	25 - 60
Speed, no load	1/min	20 - 230
Weight without storage battery	kg	1,2
<b>Part number</b>		<b>7 112 64 60 00 0</b>
<b>EAN</b>		<b>4014586883854</b>
<b>Price in € [PC05]</b>		<b>1.207,50</b>

**FEIN benefits:**

- ▶ Brushless, maintenance-free motor.
- ▶ Programmable fuel gauge on the tool.
- ▶ Freely programmable parameters: speed, direction of rotation, angle of rotation, torque, threshold, time.
- ▶ Parameters can be set for both clockwise and anti-clockwise operation.
- ▶ Can be adapted to the individual application in up to five program steps to suit your process.
- ▶ FEIN Li-ion technology for more screw connections per battery charge.
- ▶ Maintenance module records all screw connections and calibration data.
- ▶ Easy data input on the computer.
- ▶ Store data for later reuse.
- ▶ For soft and hard screwed connections.
- ▶ Sensor-based control means no loss of speed when screwdriving.
- ▶ Protection of the tool through a factory-installed password.
- ▶ Powerful lithium ion battery with capacity display.
- ▶ Angled head can be set in 60° steps.
- ▶ Tongue tools can be used.

**General accessories**



**Battery pack**  
Li-ion with charge status indicator and FEIN SafetyCell Technology. Protects the battery and tool from overload, overheating and total discharge.

Current/Voltages V	Capacity Ah	No. in pack pcs	Part number	Price in €
12	2,5	1	9 26 04 168 02 0	30,45
14,4	2,5	1	9 26 04 170 02 0	72,45
14,4	2,5	15	9 26 04 170 03 0	999,60
14,4	5	1	9 26 04 172 02 0	103,95
14,4	5	15	9 26 04 172 03 0	1.434,30
18	2,5	1	9 26 04 171 02 0	72,45
18	2,5	12	9 26 04 171 03 0	799,05
18	5	1	9 26 04 173 02 0	103,95
18	5	12	9 26 04 173 03 0	1.146,60



**Battery pack**

Current/Voltages V	Capacity Ah	Part number	Price in €
9,6	2	9 26 04 082 02 5	147,00
12	2	9 26 04 084 02 7	157,50
12	2,6	9 26 04 079 02 1	199,50



**Quick charger ALG 30**  
For FEIN NiCd and Li-ion batteries. Charge time from 25 min.

Part number	Price in €
9 26 04 096 01 0	142,80



**Multi-charger ALS 40**  
Mains cable not included.

Part number	Price in €
9 26 04 111 01 0	1.573,95



**Charging adapter**  
For the battery interface of NiCd and NiMH batteries to ALS 40, ALG 40 and ALG 30.

Part number	Price in €
9 26 04 103 01 0	19,95



**Adjustment spanner - torque**

Part number	Price in €
3 21 23 002 00 6	7,98



**Battery cover**  
for protecting the work piece surface from mechanical damages for Li-Ion battery 14.4 V 2 / 2,5 Ah

Part number	Price in €
3 21 74 015 01 0	16,80



**Battery cover**  
for protecting the work piece surface from mechanical damages for Li-Ion battery 14.4 V 4 / 5 Ah

Part number	Price in €
3 21 74 016 01 0	17,85

**Battery cover**

for protecting the work piece surface from mechanical damages for Li-Ion battery 18 V 2,5 Ah

Part number	Price in €
3 21 74 020 01 0	18,90

**Battery cover**

for protecting the work piece surface from mechanical damages for Li-Ion battery 18 V 5 Ah

Part number	Price in €
3 21 74 019 01 0	19,95

**ASM accessories**



**Protection for AccuTEC ASM**  
for protecting the work piece surface from mechanical damages

Part number	Price in €
3 14 20 120 01 0	19,95



**Coding sleeves**  
for colour IDs of different models

Colour	No. in pack pcs	Part number	Price in €
Colour mix	7	3 05 01 345 02 0	10,51
blue	10	3 05 01 348 01 0	14,07
red	10	3 05 01 349 01 0	14,07
orange	10	3 05 01 350 01 0	14,07
yellow	10	3 05 01 351 01 0	14,07
grey	10	3 05 01 346 01 0	14,07
green	10	3 05 01 347 01 0	14,07
black	10	3 05 01 345 01 0	14,07

**ASW accessories**



**Coding sleeves**  
for colour IDs of different models

Colour	No. in pack pcs	Part number	Price in €
Colour mix	7	3 05 01 352 02 0	10,51
blue	10	3 05 01 355 01 0	14,07
red	10	3 05 01 356 01 0	14,07
orange	10	3 05 01 357 01 0	14,07
yellow	10	3 05 01 358 01 0	14,07
grey	10	3 05 01 353 01 0	14,07
green	10	3 05 01 354 01 0	14,07
black	10	3 05 01 352 01 0	14,07



**AccuTEC ASW protective cover**  
for protecting the work piece surface from mechanical damages

Model	Part number	Price in €
ASW 14	3 21 74 014 01 0	16,80
ASW 18	3 21 74 024 01 0	26,25



**Angled head Basic**  
ASW 14-6 (PC), ASW 14-10 (PC), ASW 14-14 (PC)

Tool Holder	Part number	Price in €
QuickIN 1/4" Hexagon socket	9 01 02 012 01 0	427,35
3/8" Outer square	9 01 02 013 01 0	427,35
1/4" Outer square	9 01 02 014 01 0	427,35



**Angled head with output > 30 Nm**  
ASW 18-30 PC, ASW 18-45 PC

Tool Holder	Part number	Price in €
3/8" Outer square	9 01 02 015 02 0	534,45



**Angled head with output > 30 Nm**  
ASW 18-60 PC

Tool Holder	Part number	Price in €
1/2" Outer square	9 01 02 016 02 0	534,45



**Straight output**  
ASW 14-6 (PC), ASW 14-10 (PC), ASW 14-14 (PC)  
Can be used between 1.1 - 9.9 Nm.

Tool Holder	Part number	Price in €
1/4" hexagon socket	9 01 06 001 02 0	156,45
3/8" Outer square	9 01 06 002 02 0	156,45



**Plastic cover**  
for protecting the work piece surface from mechanical damages

Model	Part number	Price in €
<14 Nm	3 14 28 166 00 0	6,30
<45 Nm	3 21 74 022 01 0	12,50
<60 Nm	3 21 74 021 01 0	12,50



**Clamping adapter for angled head**  
With 1/4" square head, suitable for closed Lübberring tongue tool adapter A, only in conjunction with Premium angled head.

Part number	Price in €
6 39 01 046 00 0	943,95



**Extension**  
To reduce the reaction torque and for better accessibility. 86 mm, for ASW 14-6 (PC), ASW 14-10 (PC), ASW 14-14 (PC).

Part number	Price in €
6 42 03 004 01 0	52,50



**Extension**  
To reduce the reaction torque and for better accessibility. 100 mm, for ASW 18.

Part number	Price in €
6 42 03 005 01 0	105,00



**Handle**  
for ASW 14-30 and all ASW 18 models.

Part number	Price in €
3 21 19 150 01 0	41,90

**Accessories for ParameterControl models**



**Programming adapter**  
For all AccuTEC ParameterControl models. Supplied: Software on USB card incl. instructions, adapter and connection cable.

Part number	Price in €
9 26 04 163 02 0	387,45





	FEIN cordless MULTIMASTER AFMM 18 QSL	FEIN cordless MULTIMASTER AFMM 18 QSL Select	FEIN cordless MULTITALENT AFMT 12 QSL QuickStart	FEIN cordless MULTITALENT AFMT 12 SL Start	FEIN cordless MULTITALENT AFMT 12 QSL Select	
	The high-performance, battery-powered universal system for interior work and renovation with QuickIN and accessories for a wide range of applications.		The battery-powered, universal system for interior work and renovation with QuickIN and the basic accessories needed for sanding and sawing.		The battery-powered, universal system for interior work and renovation with QuickIN and the basic accessories needed for sanding and sawing.	
<b>Page</b>	37	37	38	38	39	
<b>Technical features</b>	Battery voltage	18 V	18 V	12 V	12 V	12 V
	Battery capacity	2,5 Ah		2,5 Ah	2,5 Ah	
	Oscillations	11 000 - 18 500 1/min	11 000 - 18 500 1/min	11 000 - 18 000 1/min	11 000 - 18 000 1/min	11 000 - 18 000 1/min
	Sanding pad width	80 mm	80 mm	80 mm	80 mm	80 mm
	Tool Holder	StarlockPlus	StarlockPlus	StarlockPlus	StarlockPlus	StarlockPlus
	Tool change	QuickIN	QuickIN	QuickIN	Manual with screw, hexagon socket	QuickIN
	Weight with battery	1,8 kg		1,5 kg	1,4 kg	
	Weight without storage battery		1,3 kg			1,1 kg
Mechanical interface	●	●				

- included

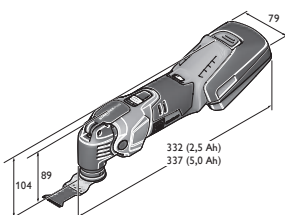

AFMM 18 QSL

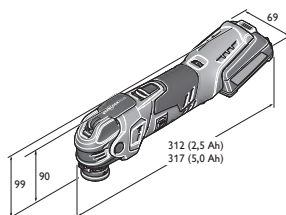

AFMT 12 QSL

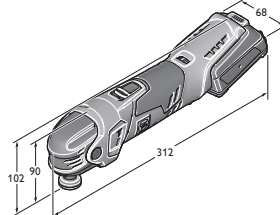

AFMT 12 SL

**FEIN cordless MULTIMASTER  
AFMM 18 QSL**

For accessories, see page 39 and 218

For mains variant of tool, see page 210

The high-performance, battery-powered universal system for interior work and renovation with QuickIN and accessories for a wide range of applications.

Battery voltage	V	18
Oscillations	1/min	11 000 - 18 500
Battery capacity	Ah	2,5
Tool Holder		StarlockPlus
Tool change		QuickIN
Amplitude		2 x 1,7°
Sanding pad width	mm	80
Weight with battery	kg	1,8
<b>Part number</b>		<b>7 129 22 61 00 0</b>
<b>EAN</b>		<b>4014586884066</b>
<b>Price in € [PC03]</b>		<b>363,30</b>

**FEIN benefits:**

- ▶ FEIN anti-vibration system. Up to 70% fewer vibrations as the external motor housing is completely separate. For permanently safe working.
- ▶ Starlock standard tool mounting. 3D form ensures the perfect fit for accessories. 100% power transmission without losses for up to 35% more work progress.
- ▶ QuickIN tool change. Patented tool-free FEIN rapid clamping system for safe and easy tool changes in less than 3 seconds.
- ▶ StarlockPlus for outstanding versatility through access to the complete range of Starlock and StarlockPlus accessories.
- ▶ DC motor. Tried and tested motor technology with compact size, effective and powerful.
- ▶ Tacho generator. High-quality electronics for constant speeds under load. Infinitely variable electronic speed setting.
- ▶ Metal gearbox. Ability to withstand high loading and outstanding service life.
- ▶ Integrated interface for additional system accessories such as depth stop etc.
- ▶ Largest range of accessories with Starlock and StarlockPlus fitting in FEIN quality.
- ▶ FEIN SafetyCell technology. Protects the battery and tool from overload, overheating and total discharge.
- ▶ The battery charge can be read off the battery.
- ▶ 3-year FEIN PLUS warranty including battery and charger.

**Price includes:**

1 FEIN cordless MULTIMASTER AFMM 18 QSL, 1 sanding pad, Sanding sheets, 3 each of grit 60, 80, 120, 180, 1 fixed scraper, 1 HSS segment saw blade, 1 E-CUT long-life saw blade (65 mm), 1 Universal E-CUT saw blade (44 mm), 1 rapid charger ALG 50, 2 Li-ion batteries (2,5 Ah), 1 plastic carrying case

**FEIN cordless MULTIMASTER  
AFMM 18 QSL Select****FEIN SELECT<sup>+</sup>**

For accessories, see page 39 and 218

For mains variant of tool, see page 210

The high-performance, battery-powered universal system for interior work and renovation with QuickIN and accessories for a wide range of applications.

Battery voltage	V	18
Oscillations	1/min	11 000 - 18 500
Tool Holder		StarlockPlus
Tool change		QuickIN
Amplitude		2 x 1,7°
Sanding pad width	mm	80
Weight without storage battery	kg	1,3
<b>Part number</b>		<b>7 129 22 62 00 0</b>
<b>EAN</b>		<b>4014586885704</b>
<b>Price in € [PC03]</b>		<b>177,45</b>

**FEIN benefits:**

- ▶ Select version - the smart choice if you already have FEIN battery and charging technology.
- ▶ FEIN anti-vibration system. Up to 70% fewer vibrations as the external motor housing is completely separate. For permanently safe working.
- ▶ Starlock standard tool mounting. 3D form ensures the perfect fit for accessories. 100% power transmission without losses for up to 35% more work progress.
- ▶ QuickIN tool change. Patented tool-free FEIN rapid clamping system for safe and easy tool changes in less than 3 seconds.
- ▶ StarlockPlus for outstanding versatility through access to the complete range of Starlock and StarlockPlus accessories.
- ▶ DC motor. Tried and tested motor technology with compact size, effective and powerful.
- ▶ Tacho generator. High-quality electronics for constant speeds under load. Infinitely variable electronic speed setting.
- ▶ Metal gearbox. Ability to withstand high loading and outstanding service life.
- ▶ Integrated interface for additional system accessories such as depth stop etc.
- ▶ Largest range of accessories with Starlock and StarlockPlus fitting in FEIN quality.
- ▶ FEIN SafetyCell technology. Protects the battery and tool from overload, overheating and total discharge.
- ▶ The battery charge can be read off the battery.
- ▶ 3-year FEIN PLUS warranty including battery and charger.

**Price includes:**

1 plastic carrying case, 1 FEIN cordless MULTIMASTER AFMM 18 QSL

**FEIN cordless MULTITALENT AFMT 12 QSL QuickStart**



For accessories, see page 39 and 218  
For mains variant of tool, see page 210

The battery-powered, universal system for interior work and renovation with QuickIN and the basic accessories needed for sanding and sawing.

Battery voltage	V	12
Oscillations	1/min	11 000 - 18 000
Battery capacity	Ah	2,5
Tool Holder		StarlockPlus
Tool change		QuickIN
Amplitude		2 x 1,6°
Sanding pad width	mm	80
Weight with battery	kg	1,5
<b>Part number</b>		<b>7 129 25 61 00 0</b>
<b>EAN</b>		<b>4014586884141</b>
<b>Price in € [PC03]</b>		<b>256,20</b>

**FEIN benefits:**

- ▶ FEIN anti-vibration system. Up to 70% fewer vibrations as the external motor housing is completely separate. For permanently safe working.
- ▶ Starlock standard tool mounting. 3D form ensures the perfect fit for accessories. 100% power transmission without losses for up to 35% more work progress.
- ▶ QuickIN tool change. Patented tool-free FEIN rapid clamping system for safe and easy tool changes in less than 3 seconds.
- ▶ StarlockPlus for outstanding versatility through access to the complete range of Starlock and StarlockPlus accessories.
- ▶ DC motor. Tried and tested motor technology with compact size, effective and powerful.
- ▶ Tacho generator. High-quality electronics for constant speeds under load. Infinitely variable electronic speed setting.
- ▶ Metal gearbox. Ability to withstand high loading and outstanding service life.
- ▶ Largest range of accessories with Starlock and StarlockPlus fitting in FEIN quality.
- ▶ FEIN SafetyCell technology. Protects the battery and tool from overload, overheating and total discharge.
- ▶ The battery charge can be read off the battery.
- ▶ 3-year FEIN PLUS warranty including battery and charger.

**Price includes:**

1 FEIN cordless MULTITALENT AFMT 12 QSL, 1 sanding pad, Sanding sheets, 3 each of grit 80, 120, 180, 1 Universal E-CUT saw blade (29 mm), 1 rapid charger ALG 50, 2 Li-ion batteries (2,5 Ah), 1 plastic carrying case

**FEIN cordless MULTITALENT AFMT 12 SL Start**



For accessories, see page 39 and 218  
For mains variant of tool, see page 210

The battery-powered, universal system for interior work and renovation and the basic accessories needed for sanding and sawing.

Battery voltage	V	12
Oscillations	1/min	11 000 - 18 000
Battery capacity	Ah	2,5
Tool Holder		StarlockPlus
Tool change		Manual with screw, hexagon socket
Amplitude		2 x 1,6°
Sanding pad width	mm	80
Weight with battery	kg	1,4
<b>Part number</b>		<b>7 129 26 61 00 0</b>
<b>EAN</b>		<b>4014586884226</b>
<b>Price in € [PC03]</b>		<b>235,20</b>

**FEIN benefits:**

- ▶ FEIN anti-vibration system. Up to 70% fewer vibrations as the external motor housing is completely separate. For permanently safe working.
- ▶ Starlock standard tool mounting. 3D form ensures the perfect fit for accessories. 100% power transmission without losses for up to 35% more work progress.
- ▶ StarlockPlus for outstanding versatility through access to the complete range of Starlock and StarlockPlus accessories.
- ▶ DC motor. Tried and tested motor technology with compact size, effective and powerful.
- ▶ Tacho generator. High-quality electronics for constant speeds under load. Infinitely variable electronic speed setting.
- ▶ Metal gearbox. Ability to withstand high loading and outstanding service life.
- ▶ Largest range of accessories with Starlock and StarlockPlus fitting in FEIN quality.
- ▶ FEIN SafetyCell technology. Protects the battery and tool from overload, overheating and total discharge.
- ▶ The battery charge can be read off the battery.
- ▶ 3-year FEIN PLUS warranty including battery and charger.

**Price includes:**

1 FEIN cordless MULTITALENT 12 SL, 1 sanding pad, Sanding sheets, 3 each of grit 80, 120, 180, 1 Universal E-CUT saw blade (29 mm), 1 rapid charger ALG 50, 2 Li-ion batteries (2,5 Ah), 1 plastic carrying case

**FEIN cordless MULTITALENT AFMT 12 QSL Select**

The battery-powered, universal system for interior work and renovation with QuickIN and the basic accessories needed for sanding and sawing.

**FEIN SELECT<sup>+</sup>**



For accessories, see page 39 and 218  
For mains variant of tool, see page 210

Battery voltage	V	12
Oscillations	1/min	11 000 - 18 000
Tool Holder		StarlockPlus
Tool change		QuickIN
Amplitude		2 x 1,6°
Sanding pad width	mm	80
Weight without storage battery	kg	1,1
<b>Part number</b>		<b>7 129 25 62 00 0</b>
<b>EAN</b>		<b>4014586885711</b>
<b>Price in € [PC03]</b>		<b>154,35</b>

**FEIN benefits:**

- ▶ Select version - the smart choice if you already have FEIN battery and charging technology.
- ▶ FEIN anti-vibration system. Up to 70% fewer vibrations as the external motor housing is completely separate. For permanently safe working.
- ▶ StarLock standard tool mounting. 3D form ensures the perfect fit for accessories. 100% power transmission without losses for up to 35% more work progress.
- ▶ StarlockPlus for outstanding versatility through access to the complete range of Starlock and StarlockPlus accessories.
- ▶ DC motor. Tried and tested motor technology with compact size, effective and powerful.
- ▶ Tacho generator. High-quality electronics for constant speeds under load. Infinitely variable electronic speed setting.
- ▶ Metal gearbox. Ability to withstand high loading and outstanding service life.
- ▶ Largest range of accessories with Starlock and StarlockPlus fitting in FEIN quality.
- ▶ FEIN SafetyCell technology. Protects the battery and tool from overload, overheating and total discharge.
- ▶ The battery charge can be read off the battery.
- ▶ 3-year FEIN PLUS warranty including battery and charger.

**Price includes:**

1 plastic carrying case, 1 FEIN cordless MULTITALENT AFMT 12 QSL

MULTIMASTER / MULTITALENT

**General accessories**



**Quick charger ALG 50**  
For all FEIN Li-ion batteries. Charge time from 35 min.

Part number	Price in €
9 26 04 129 01 0	40,95



**Quick charger ALG 30**  
For FEIN NiCd and Li-ion batteries. Charge time from 25 min.

Part number	Price in €
9 26 04 096 01 0	142,80

**18 V battery**



**Battery pack**  
Li-ion with charge status indicator and FEIN SafetyCell Technology. Protects the battery and tool from overload, overheating and total discharge.

Current/Voltages	Capacity	Part number	Price in €
V	Ah		
18	2,5	9 26 04 171 02 0	72,45
18	5	9 26 04 173 02 0	103,95



**Battery starter set**  
Very durable, light 18 V Li-ion batteries with innovative SafetyCell technology, 5Ah capacity and charge indicator.

Part number	Price in €
9 26 04 300 03 0	248,85



**Battery starter set**  
Small and light 18 V Li-ion batteries with innovative SafetyCell technology, 2,5 Ah capacity and charge indicator.

Part number	Price in €
9 26 04 300 04 0	185,85

**12 V battery**



**Battery pack**  
Li-ion with charge status indicator and FEIN SafetyCell Technology. Protects the battery and tool from overload, overheating and total discharge.

Current/Voltages	Capacity	Part number	Price in €
V	Ah		
12	2,5	9 26 04 168 02 0	30,45



**Battery starter set**  
Very durable, light 12 V Li-ion batteries with innovative SafetyCell technology, 2,5 Ah capacity and charge indicator.

Part number	Price in €
9 26 04 250 01 0	101,85



	FEIN cordless SUPER-CUT AFSC 18 QSL	FEIN cordless SUPER-CUT AFSC 18 QCSL	FEIN cordless SUPER-CUT AFSC 18 QSL Select	FEIN cordless SUPER-CUT AFSC 18 QSL for interior work with wood	FEIN cordless SUPER-CUT AFSC 18 QSL for repairing/re- placing windows	
	The most powerful cordless oscillator with rapid clamping system for interior work and renovation.			The most powerful system for interior work and renovation with special accessories for fast and precise sawing work when fitting wood.	The most powerful system for interior work and renovation with special accessories for dismantling old windows and replacing putty-mounted insulating glass.	
<b>Page</b>	42	42	43	43	44	
<b>Technical features</b>	Battery voltage	18 V	18 V	18 V	18 V	18 V
	Battery capacity	5 Ah	2,5 Ah		5 Ah	5 Ah
	Oscillations	10 000 - 19 500 1/min	10 000 - 19 500 1/min	10 000 - 19 500 1/min	10 000 - 19 500 1/min	10 000 - 19 500 1/min
	Amplitude	2 x 2,0°	2 x 2,0°	2 x 2,0°	2 x 2,0°	2 x 2,0°
	Tool Holder	StarlockMax	StarlockMax	StarlockMax	StarlockMax	StarlockMax
	Tool change	QuickIN	QuickIN	QuickIN	QuickIN	QuickIN
	Weight with battery	1,8 kg	1,6 kg		1,8 kg	1,8 kg
	Weight without storage battery	1,1 kg	1,1 kg	1,1 kg		1,1 kg
Mechanical interface	●	●	●	●	●	

- included

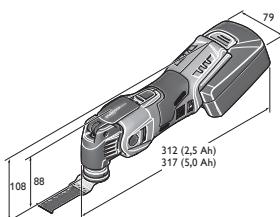

AFSC 18 QSL



FEIN cordless SUPERCUT AFSC 18 QSL for tile restoration/ bathroom renovation	FEIN cordless SUPERCUT AFSC 18 QSL for heating/ sanitary installation	FEIN cordless SUPERCUT AFSC 1.7 Q	FEIN cordless SUPERCUT AFSC 1.7 QC	FEIN cordless SUPERCUT AFSC 1.7 Q Auto Glass
The most powerful system for interior work and renovation with special accessories for perfect removal of tiles and joints in bathroom renovation.	The most powerful system for interior work and renovation with special accessories for the key applications in sanitary repairs.	The high-performance battery-powered oscillator with quick clamping system for the automotive industry.		The powerful system for vehicle repairs with special accessories for quick and safe removal of vehicle windows.
44	45	45	46	46
18 V	18 V	18 V	18 V	18 V
5 Ah	5 Ah	5 Ah	2,5 Ah	5 Ah
10 000 - 19 500 1/min	10 000 - 19 500 1/min	10 000 - 19 500 1/min	10 000 - 19 500 1/min	10 000 - 19 500 1/min
2 x 2,0°	2 x 2,0°	2 x 1,7°	2 x 1,7°	2 x 1,7°
StarlockMax	StarlockMax	Hexagon	Hexagon	Hexagon
QuickIN	QuickIN	QuickIN	QuickIN	QuickIN
1,8 kg	1,8 kg	1,8 kg	1,6 kg	1,8 kg
1,1 kg	1,1 kg	0,9 kg	0,9 kg	0,9 kg

●

●



**FEIN cordless SUPERCUT  
AFSC 18 QSL**



For accessories, see page 47 and 218  
For mains variant of tool, see page 214

The most powerful cordless oscillator with rapid clamping system for interior work and renovation.

Battery voltage	V	18
Oscillations	1/min	10 000 - 19 500
Battery capacity	Ah	5
Tool Holder		StarlockMax
Tool change		QuickIN
Amplitude		2 x 2,0°
Weight with battery	kg	1,8
Weight without storage battery	kg	1,1
<b>Part number</b>		<b>7 129 27 61 00 0</b>
<b>EAN</b>		<b>4014586884301</b>
<b>Price in € [PC03]</b>		<b>499,80</b>

**FEIN benefits:**

- ▶ The most powerful cordless oscillating multi-tool available in the basic version. The right choice for any requirement.
- ▶ FEIN anti-vibration system. Up to 70% fewer vibrations as the external motor housing is completely separate. For permanently safe working.
- ▶ Starlock standard tool mounting. 3D form ensures the perfect fit for accessories. 100% power transmission without losses for up to 35% more work progress.
- ▶ QuickIN tool change. Patented tool-free FEIN rapid clamping system for safe and easy tool changes in less than 3 seconds.
- ▶ StarlockMax for unlimited versatility through access to the complete range of Starlock accessories.
- ▶ Brushless FEIN PowerDrive motor, fully encapsulated and dust-protected with 30% higher efficiency and long service life.
- ▶ High-quality electronics for constant speeds under load. Infinitely variable electronic speed setting.
- ▶ Metal gearbox. Ability to withstand high loading and outstanding service life.
- ▶ Integrated interface for additional system accessories such as depth stop etc.
- ▶ Largest range of accessories with Starlock, StarlockPlus and StarlockMax fitting in FEIN quality.
- ▶ FEIN SafetyCell technology. Protects the battery and tool from overload, overheating and total discharge.
- ▶ The battery charge can be read off the battery.
- ▶ 3-year FEIN PLUS warranty including battery and charger.

**Price includes:**

1 FEIN cordless SUPERCUT AFSC 18 QSL, 2 battery packs (Li-ion), 1 battery charger, 1 plastic carrying case

**FEIN cordless SUPERCUT  
AFSC 18 QCSL**



For accessories, see page 47 and 218  
For mains variant of tool, see page 214

The most powerful cordless oscillator with rapid clamping system for interior work and renovation.

Battery voltage	V	18
Oscillations	1/min	10 000 - 19 500
Battery capacity	Ah	2,5
Tool Holder		StarlockMax
Tool change		QuickIN
Amplitude		2 x 2,0°
Weight with battery	kg	1,6
Weight without storage battery	kg	1,1
<b>Part number</b>		<b>7 129 27 62 00 0</b>
<b>EAN</b>		<b>4014586884349</b>
<b>Price in € [PC03]</b>		<b>436,80</b>

**FEIN benefits:**

- ▶ The most powerful cordless oscillating multi-tool with compact batteries for optimum handling and low weight.
- ▶ FEIN anti-vibration system. Up to 70% fewer vibrations as the external motor housing is completely separate. For permanently safe working.
- ▶ Starlock standard tool mounting. 3D form ensures the perfect fit for accessories. 100% power transmission without losses for up to 35% more work progress.
- ▶ QuickIN tool change. Patented tool-free FEIN rapid clamping system for safe and easy tool changes in less than 3 seconds.
- ▶ StarlockMax for unlimited versatility through access to the complete range of Starlock accessories.
- ▶ Brushless FEIN PowerDrive motor, fully encapsulated and dust-protected with 30% higher efficiency and long service life.
- ▶ High-quality electronics for constant speeds under load. Infinitely variable electronic speed setting.
- ▶ Metal gearbox. Ability to withstand high loading and outstanding service life.
- ▶ Integrated interface for additional system accessories such as depth stop etc.
- ▶ Largest range of accessories with Starlock, StarlockPlus and StarlockMax fitting in FEIN quality.
- ▶ FEIN SafetyCell technology. Protects the battery and tool from overload, overheating and total discharge.
- ▶ The battery charge can be read off the battery.
- ▶ 3-year FEIN PLUS warranty including battery and charger.

**Price includes:**

1 FEIN cordless SUPERCUT AFSC 18 QCSL, 1 battery charger, 2 battery packs (Li-ion), 1 plastic carrying case



**FEIN cordless SUPERCUT  
AFSC 18 QSL Select**

**FEIN SELECT<sup>+</sup>**



For accessories, see page 47 and 218  
For mains variant of tool, see page 214

The most powerful cordless oscillator with rapid clamping system for interior work and renovation.

Battery voltage	V	18
Oscillations	1/min	10 000 - 19 500
Tool Holder		StarlockMax
Tool change		QuickIN
Amplitude		2 x 2,0°
Weight without storage battery	kg	1,1
<b>Part number</b>		<b>7 129 27 60 00 0</b>
<b>EAN</b>		<b>4014586884295</b>
<b>Price in € [PC03]</b>		<b>250,95</b>

Tool must only be operated with new 2.5 Ah (9 26 04 171 02 0) or 5 Ah (9 26 04 173 02 0) storage batteries.

**FEIN benefits:**

- ▶ Select version - the smart choice if you already have FEIN battery and charging technology.
- ▶ FEIN anti-vibration system. Up to 70% fewer vibrations as the external motor housing is completely separate. For permanently safe working.
- ▶ Starlock standard tool mounting. 3D form ensures the perfect fit for accessories. 100% power transmission without losses for up to 35% more work progress.
- ▶ QuickIN tool change. Patented tool-free FEIN rapid clamping system for safe and easy tool changes in less than 3 seconds.
- ▶ StarlockMax for unlimited versatility through access to the complete range of Starlock accessories.
- ▶ Brushless FEIN PowerDrive motor, fully encapsulated and dust-protected with 30% higher efficiency and long service life.
- ▶ High-quality electronics for constant speeds under load. Infinitely variable electronic speed setting.
- ▶ Metal gearbox. Ability to withstand high loading and outstanding service life.
- ▶ Integrated interface for additional system accessories such as depth stop etc.
- ▶ Largest range of accessories with Starlock, StarlockPlus and StarlockMax fitting in FEIN quality.
- ▶ FEIN SafetyCell technology. Protects the battery and tool from overload, overheating and total discharge.
- ▶ The battery charge can be read off the battery.
- ▶ 3-year FEIN PLUS warranty including battery and charger.

**Price includes:**

1 FEIN cordless SUPERCUT AFSC 18 QSL, 1 plastic carrying case

**FEIN cordless SUPERCUT  
AFSC 18 QSL  
for interior work with wood**



For accessories, see page 47 and 218  
For mains variant of tool, see page 214

The most powerful system for interior work and renovation with special accessories for fast and precise sawing work when fitting wood.

Battery voltage	V	18
Oscillations	1/min	10 000 - 19 500
Battery capacity	Ah	5
Tool Holder		StarlockMax
Tool change		QuickIN
Amplitude		2 x 2,0°
Weight with battery	kg	1,8
<b>Part number</b>		<b>7 129 27 64 00 0</b>
<b>EAN</b>		<b>4014586884387</b>
<b>Price in € [PC03]</b>		<b>609,00</b>

**FEIN benefits:**

- ▶ FEIN anti-vibration system. Up to 70% fewer vibrations as the external motor housing is completely separate. For permanently safe working.
- ▶ Starlock standard tool mounting. 3D form ensures the perfect fit for accessories. 100% power transmission without losses for up to 35% more work progress.
- ▶ QuickIN tool change. Patented tool-free FEIN rapid clamping system for safe and easy tool changes in less than 3 seconds.
- ▶ StarlockMax for unlimited versatility through access to the complete range of Starlock accessories.
- ▶ Brushless FEIN PowerDrive motor, fully encapsulated and dust-protected with 30% higher efficiency and long service life.
- ▶ High-quality electronics for constant speeds under load. Infinitely variable electronic speed setting.
- ▶ Metal gearbox. Ability to withstand high loading and outstanding service life.
- ▶ Integrated interface for additional system accessories such as depth stop etc.
- ▶ Largest range of accessories with Starlock, StarlockPlus and StarlockMax fitting in FEIN quality.
- ▶ FEIN SafetyCell technology. Protects the battery and tool from overload, overheating and total discharge.
- ▶ The battery charge can be read off the battery.
- ▶ 3-year FEIN PLUS warranty including battery and charger.

**Price includes:**

1 FEIN cordless SUPERCUT AFSC 18 QSL, 1 HSS saw blade wood Ø 100 mm, 1 depth stop, 2 E-CUT precision BIM saw blades (form 205, 208), 5 E-CUT long-life saw blades (form 183, 160, 161, 201, 203), 2 E-CUT universal saw blades (form 151, 152), 1 sanding pad, 5 Sanding sheets each grit size (K 80, 120, 180), 2 battery packs (Li-ion), 1 battery charger, 1 plastic carrying case

**FEIN cordless SUPERCUT  
AFSC 18 QSL  
for repairing/replacing windows**



For accessories, see page 47 and 218  
For mains variant of tool, see page 214

The most powerful system for interior work and renovation with special accessories for dismantling old windows and replacing putty-mounted insulating glass.

Battery voltage	V	18
Oscillations	1/min	10 000 - 19 500
Battery capacity	Ah	5
Tool Holder		StarlockMax
Tool change		QuickIN
Amplitude		2 x 2,0°
Weight with battery	kg	1,8
Weight without storage battery	kg	1,1
<b>Part number</b>		<b>7 129 27 66 00 0</b>
<b>EAN</b>		<b>4014586884424</b>
<b>Price in € [PC03]</b>		<b>609,00</b>

**FEIN benefits:**

- ▶ FEIN anti-vibration system. Up to 70% fewer vibrations as the external motor housing is completely separate. For permanently safe working.
- ▶ Starlock standard tool mounting. 3D form ensures the perfect fit for accessories. 100% power transmission without losses for up to 35% more work progress.
- ▶ QuickIN tool change. Patented tool-free FEIN rapid clamping system for safe and easy tool changes in less than 3 seconds.
- ▶ StarlockMax for unlimited versatility through access to the complete range of Starlock accessories.
- ▶ Brushless FEIN PowerDrive motor, fully encapsulated and dust-protected with 30% higher efficiency and long service life.
- ▶ High-quality electronics for constant speeds under load. Infinitely variable electronic speed setting.
- ▶ Metal gearbox. Ability to withstand high loading and outstanding service life.
- ▶ Integrated interface for additional system accessories such as depth stop etc.
- ▶ Largest range of accessories with Starlock, StarlockPlus and StarlockMax fitting in FEIN quality.
- ▶ FEIN SafetyCell technology. Protects the battery and tool from overload, overheating and total discharge.
- ▶ The battery charge can be read off the battery.
- ▶ 3-year FEIN PLUS warranty including battery and charger.

**Price includes:**

1 FEIN cordless SUPERCUT AFSC 18 QSL, 1 HSS saw blade wood Ø 100 mm, 1 HSS saw blade for metal (diameter 100 mm), 1 E-CUT long-life saw blade (form 203), 1 E-CUT universal saw blade (form 152), 1 Cutter blade, mushroom shaped, 1 segment saw blade (form 244), 1 depth stop, 1 sanding pad, 5 Sanding sheets each grit size (K 80, 120, 180), 2 battery packs (Li-ion), 1 battery charger, 1 plastic carrying case

**FEIN cordless SUPERCUT  
AFSC 18 QSL for tile restoration/  
bathroom renovation**



For accessories, see page 47 and 218  
For mains variant of tool, see page 214

The most powerful system for interior work and renovation with special accessories for perfect removal of tiles and joints in bathroom renovation.

Battery voltage	V	18
Oscillations	1/min	10 000 - 19 500
Battery capacity	Ah	5
Tool Holder		StarlockMax
Tool change		QuickIN
Amplitude		2 x 2,0°
Weight with battery	kg	1,8
Weight without storage battery	kg	1,1
<b>Part number</b>		<b>7 129 27 67 00 0</b>
<b>EAN</b>		<b>4014586884431</b>
<b>Price in € [PC03]</b>		<b>609,00</b>

**FEIN benefits:**

- ▶ FEIN anti-vibration system. Up to 70% fewer vibrations as the external motor housing is completely separate. For permanently safe working.
- ▶ Starlock standard tool mounting. 3D form ensures the perfect fit for accessories. 100% power transmission without losses for up to 35% more work progress.
- ▶ QuickIN tool change. Patented tool-free FEIN rapid clamping system for safe and easy tool changes in less than 3 seconds.
- ▶ StarlockMax for unlimited versatility through access to the complete range of Starlock accessories.
- ▶ Brushless FEIN PowerDrive motor, fully encapsulated and dust-protected with 30% higher efficiency and long service life.
- ▶ High-quality electronics for constant speeds under load. Infinitely variable electronic speed setting.
- ▶ Metal gearbox. Ability to withstand high loading and outstanding service life.
- ▶ Integrated interface for additional system accessories such as depth stop etc.
- ▶ Largest range of accessories with Starlock, StarlockPlus and StarlockMax fitting in FEIN quality.
- ▶ FEIN SafetyCell technology. Protects the battery and tool from overload, overheating and total discharge.
- ▶ The battery charge can be read off the battery.
- ▶ 3-year FEIN PLUS warranty including battery and charger.

**Price includes:**

1 FEIN cordless SUPERCUT AFSC 18 QSL, 1 segment blade, diamond-coated (form 243), 1 carbide saw blade, diameter 105 mm (form 214), 2 E-CUT universal saw blades (form 151, 152), 1 Cutter blade, mushroom shaped, 1 Stopper knife, 2 Rasps, carbide-coated, triangular, perforated for dust extractor, 2 battery packs (Li-ion), 1 battery charger, 1 plastic carrying case



**FEIN cordless SUPERCUT  
AFSC 18 QSL  
for heating/sanitary installation**



For accessories, see page 47 and 218  
For mains variant of tool, see page 214

The most powerful system for interior work and renovation with special accessories for the key applications in sanitary repairs.

Battery voltage	V	18
Oscillations	1/min	10 000 - 19 500
Battery capacity	Ah	5
Tool Holder		StarlockMax
Tool change		QuickIN
Amplitude		2 x 2,0°
Weight with battery	kg	1,8
Weight without storage battery	kg	1,1
<b>Part number</b>		<b>7 129 27 68 00 0</b>
<b>EAN</b>		<b>4014586884448</b>
<b>Price in € [PC03]</b>		<b>609,00</b>

**FEIN benefits:**

- ▶ FEIN anti-vibration system. Up to 70% fewer vibrations as the external motor housing is completely separate. For permanently safe working.
- ▶ Starlock standard tool mounting. 3D form ensures the perfect fit for accessories. 100% power transmission without losses for up to 35% more work progress.
- ▶ QuickIN tool change. Patented tool-free FEIN rapid clamping system for safe and easy tool changes in less than 3 seconds.
- ▶ StarlockMax for unlimited versatility through access to the complete range of Starlock accessories.
- ▶ Brushless FEIN PowerDrive motor, fully encapsulated and dust-protected with 30% higher efficiency and long service life.
- ▶ High-quality electronics for constant speeds under load. Infinitely variable electronic speed setting.
- ▶ Metal gearbox. Ability to withstand high loading and outstanding service life.
- ▶ Integrated interface for additional system accessories such as depth stop etc.
- ▶ Largest range of accessories with Starlock, StarlockPlus and StarlockMax fitting in FEIN quality.
- ▶ FEIN SafetyCell technology. Protects the battery and tool from overload, overheating and total discharge.
- ▶ The battery charge can be read off the battery.
- ▶ 3-year FEIN PLUS warranty including battery and charger.

**Price includes:**

1 FEIN cordless SUPERCUT AFSC 18 QSL, 1 segment blade, diamond-coated (form 243), 1 of each cutting tool (12, 13 and 22 mm), 1 cutter blade, straight, long (form 239), 2 E-Cut universal saw blades (form 151, 152), 1 Stopper knife, 1 carbide-coated rasp, triangular, perforated for dust extraction, 2 battery packs (Li-ion), 1 battery charger, 1 plastic carrying case

**FEIN cordless SUPERCUT  
AFSC 1.7 Q**



For accessories, see page 47 and 242  
For mains variant of tool, see page 214

The high-performance battery-powered oscillator with quick clamping system for the automotive industry.

Battery voltage	V	18
Oscillations	1/min	10 000 - 19 500
Battery capacity	Ah	5
Tool Holder		Hexagon
Tool change		QuickIN
Amplitude		2 x 1,7°
Weight with battery	kg	1,8
Weight without storage battery	kg	0,9
<b>Part number</b>		<b>7 129 18 63 00 0</b>
<b>EAN</b>		<b>4014586885209</b>
<b>Price in € [PC03]</b>		<b>492,45</b>

**FEIN benefits:**

- ▶ Basic equipment. The right choice for flexible use.
- ▶ FEIN anti-vibration system. Up to 70% fewer vibrations as the external motor housing is completely separate. For permanently safe working.
- ▶ Hexagonal tool holder for optimum torque transfer.
- ▶ QuickIN tool change. Patented tool-free FEIN rapid clamping system for safe and easy tool changes.
- ▶ Brushless FEIN PowerDrive motor, fully encapsulated and dust-protected with 30% higher efficiency and long service life.
- ▶ High-quality electronics for constant speeds under load. Infinitely variable electronic speed setting.
- ▶ Metal gearbox. Ability to withstand high loading and outstanding service life.
- ▶ Factory-recommended by leading automobile manufacturers.
- ▶ FEIN SafetyCell technology. Protects the battery and tool from overload, overheating and total discharge.
- ▶ The battery charge can be read off the battery.
- ▶ 3-year FEIN PLUS warranty including battery and charger.

**Price includes:**

1 battery charger, 1 sharpening stone (6 37 19 010 01 4), 1 plastic carrying case, 1 FEIN cordless SUPERCUT AFSC 1.7 Q, 2 battery packs (Li-ion), 1 protective cover for tool changes

**FEIN cordless SUPERCUT  
AFSC 1.7 QC**



For accessories, see page 47 and 242  
For mains variant of tool, see page 214

The high-performance battery-powered oscillator with quick clamping system for the automotive industry.

Battery voltage	V	18
Oscillations	1/min	10 000 - 19 500
Battery capacity	Ah	2,5
Tool Holder		Hexagon
Tool change		QuickIN
Amplitude		2 x 1,7°
Weight with battery	kg	1,6
Weight without storage battery	kg	0,9
<b>Part number</b>		<b>7 129 18 62 00 0</b>
<b>EAN</b>		<b>4014586885186</b>
<b>Price in € [PC03]</b>		<b>418,95</b>

**FEIN benefits:**

- ▶ Basic equipment with compact batteries for optimum handling and low weight.
- ▶ FEIN anti-vibration system. Up to 70% fewer vibrations as the external motor housing is completely separate. For permanently safe working.
- ▶ Hexagonal tool holder for optimum torque transfer.
- ▶ QuickIN tool change. Patented tool-free FEIN rapid clamping system for safe and easy tool changes.
- ▶ Brushless FEIN PowerDrive motor, fully encapsulated and dust-protected with 30% higher efficiency and long service life.
- ▶ High-quality electronics for constant speeds under load. Infinitely variable electronic speed setting.
- ▶ Metal gearbox. Ability to withstand high loading and outstanding service life.
- ▶ Factory-recommended by leading automobile manufacturers.
- ▶ FEIN SafetyCell technology. Protects the battery and tool from overload, overheating and total discharge.
- ▶ The battery charge can be read off the battery.
- ▶ 3-year FEIN PLUS warranty including battery and charger.

**Price includes:**

1 sharpening stone (6 37 19 010 01 4), 1 plastic carrying case, 1 protective cover for tool changes, 2 battery packs (Li-ion), 1 battery charger, 1 FEIN cordless SUPERCUT AFSC 1.7 QC

**FEIN cordless SUPERCUT  
AFSC 1.7 Q Auto Glass**



For accessories, see page 47 and 242  
For mains variant of tool, see page 214

The powerful system for vehicle repairs with special accessories for quick and safe removal of vehicle windows.

Battery voltage	V	18
Oscillations	1/min	10 000 - 19 500
Battery capacity	Ah	5
Tool Holder		Hexagon
Tool change		QuickIN
Amplitude		2 x 1,7°
Weight with battery	kg	1,8
Weight without storage battery	kg	0,9
<b>Part number</b>		<b>7 129 18 61 00 0</b>
<b>EAN</b>		<b>4014586884004</b>
<b>Price in € [PC03]</b>		<b>597,45</b>

**FEIN benefits:**

- ▶ FEIN anti-vibration system. Up to 70% fewer vibrations as the external motor housing is completely separate. For permanently safe working.
- ▶ Hexagonal tool holder for optimum torque transfer.
- ▶ QuickIN tool change. Patented tool-free FEIN rapid clamping system for safe and easy tool changes.
- ▶ Brushless FEIN PowerDrive motor, fully encapsulated and dust-protected with 30% higher efficiency and long service life.
- ▶ High-quality electronics for constant speeds under load. Infinitely variable electronic speed setting.
- ▶ Metal gearbox. Ability to withstand high loading and outstanding service life.
- ▶ Factory-recommended by leading automobile manufacturers.
- ▶ FEIN SafetyCell technology. Protects the battery and tool from overload, overheating and total discharge.
- ▶ The battery charge can be read off the battery.
- ▶ 3-year FEIN PLUS warranty including battery and charger.

**Price includes:**

1 battery charger, 1 Straight cutter blade, Z-bend, toothed (form 081), 1 each U-shaped cutter blade, reinforced design (forms 157 and 111), 1 protective cover for tool changes, 1 L-shaped cutter blade, toothed (form 209), 2 L-shaped cutter blades, toothed (form 208), 2 battery packs (Li-ion), 2 U-shaped cutter blades, reinforced design, toothed (form 212), 1 FEIN cordless SUPERCUT AFSC 1.7 Q, 3 L-shaped cutter blades, toothed (form 207), 1 sharpening stone (6 37 19 010 01 4), 1 Straight cutter blade, Z-bend, with adjustable roller stop (form 143), 1 plastic carrying case



**General accessories**



**Quick charger ALG 50**  
For all FEIN Li-ion batteries. Charge time from 35 min.

Part number	Price in €
9 26 04 129 01 0	40,95



**Quick charger ALG 30**  
For FEIN NiCd and Li-ion batteries. Charge time from 25 min.

Part number	Price in €
9 26 04 096 01 0	142,80



**Systemer Sys 2**  
Plastic, inner dimensions: H 127.5 x W 383 x D 267 mm  
The tool-specific Systemer insert must be ordered separately.

Part number	Price in €
3 39 01 147 00 0	55,61

**18 V battery**



**Battery pack**  
Li-ion with charge status indicator and FEIN SafetyCell Technology.  
Protects the battery and tool from overload, overheating and total discharge.

Current/Voltages	Capacity	Part number	Price in €
V	Ah		
18	2,5	9 26 04 171 02 0	72,45
18	5	9 26 04 173 02 0	103,95



**Battery starter set**  
Very durable, light 18 V Li-ion batteries with innovative SafetyCell technology, 5 Ah capacity and charge indicator.

Part number	Price in €
9 26 04 300 03 0	248,85



**Battery starter set**  
Small and light 18 V Li-ion batteries with innovative SafetyCell technology, 2.5 Ah capacity and charge indicator.

Part number	Price in €
9 26 04 300 04 0	185,85





	ABSS 18 1.6 E Select	ABLS 18 1.6 E Select	ABLK 18 1.6 E Select	ABLK 18 1.3 CSE Select	ABLK 18 1.3 TE Select	
	Easy-to-use, curve-compatible cordless slitting shears for distortion-free cuts and cut-outs in sheet metal up to 1.6 mm.		Compact and curve-compatible nibbler for roof and façade construction. Precise cuts in trapezoid and corrugated sheet metals and profiles.	Compact and curve-compatible nibbler for roof and façade construction. Precise cuts in corrugated sheet metal up to 1.3 mm.	Compact and curve-compatible nibbler for roof and façade construction. Precise cuts in trapezoid sheet metal up to 1.3 mm.	
<b>Page</b>	49	49	49	50	50	
<b>Application</b>	Cuts	▲▲	▲▲			
	Cut-outs	▲▲		▲	▲	
	Curve cuts	▲	▲	▲▲	▲▲	▲▲
<b>Equipment</b>	QuickIN	●		●	●	
	Cutting direction			8 x 45°	8 x 45°	8 x 45°
	Rotating round punch			●	●	●
<b>Technical features</b>	Battery voltage	18 V	18 V	18 V	18 V	18 V
	Cutting speed	5 - 8 m/min	6 - 9 m/min	1,5 m/min	1,9 m/min	1,9 m/min
	Steel up to 400 N/mm <sup>2</sup>	1,6 mm	1,6 mm	1,6 mm	1,3 mm	1,3 mm
	Steel up to 600 N/mm <sup>2</sup>	1,2 mm	1,2 mm	1 mm	0,8 mm	0,8 mm
	Steel up to 800 N/mm <sup>2</sup>	0,8 mm	1 mm	0,7 mm	0,6 mm	0,6 mm
	Non-ferrous metals up to 250 N/mm <sup>2</sup>	2 mm	2 mm	2,5 mm	2 mm	2 mm
	Weight without storage battery	1,2 kg	1,4 kg	1,65 kg	1,6 kg	1,6 kg

▲ suitability    ▲▲ optimal suitability    ● included

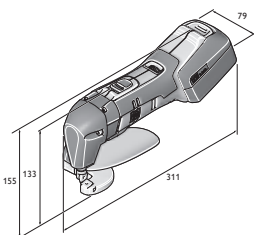

ABLK 18-1.6 E

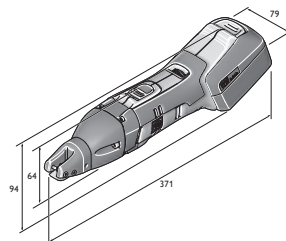

ABSS 18-1.6 E

**ABSS 18 1.6 E Select**

Easy-to-use, curve-compatible cordless slitting shears for distortion-free cuts and cut-outs in sheet metal up to 1.6 mm.

**FEIN SELECT<sup>+</sup>**For accessories, see page 51  
For mains variant of tool, see page 122

Battery voltage	V	18
Strokes	1/min	2 200 - 3 500
Cutting speed	m/min	5 - 8
Steel up to 400 N/mm <sup>2</sup>	mm	1,6
Steel up to 600 N/mm <sup>2</sup>	mm	1,2
Steel up to 800 N/mm <sup>2</sup>	mm	0,8
Non-ferrous metals up to 250 N/mm <sup>2</sup>	mm	2
Cutting width	mm	5
Rad. of smallest curve	mm	90 (30) <sup>1</sup>
Immersion Ø	mm	15 (8) <sup>1</sup>
Weight without storage battery	kg	1,2
<b>Part number</b>		<b>7 130 03 61 00 0</b>
<b>EAN</b>		<b>4014586886640</b>
<b>Price in € [PC01]</b>		<b>523,95</b>

**FEIN benefits:**

- ▶ Rapid work progress due to excellent view of the cutting line through the open-fronted cutting head.
- ▶ Left and right curve cuts and distortion-free cutting possible with just one continuous chip.
- ▶ QuickIN for rapid toolfree blade changing, with no further adjustment required.
- ▶ MultiVolt interface. Cordless tool can be operated with all FEIN Li-ion batteries (12-18 V).
- ▶ Excellent ergonomics and low weight.
- ▶ Proven MULTIMASTER motor with outstanding performance and stability.
- ▶ Cutting blade with excellent tool life.
- ▶ Cutting capacity with one battery charge: 120 m.
- ▶ Clean swarf removal prevents injuries or scratches on workpieces.
- ▶ Stainless steel up to 1.2 mm.
- ▶ Wide range of accessories.
- ▶ <sup>1</sup> with blade for curves

**Price includes:**

1 ABSS 18 1.6 E, 1 Knife, straight, up to 1.6 mm, 1 pair of cutting bars, 1 key, 1 plastic carrying case

**ABLS 18 1.6 E Select**

Easy-to-use, curve-compatible cordless slitting shears for distortion-free cuts and cut-outs in sheet metal up to 1.6 mm.

**FEIN SELECT<sup>+</sup>**For accessories, see page 51  
For mains variant of tool, see page 125

Battery voltage	V	18
Strokes	1/min	2 200 - 3 700
Cutting speed	m/min	6 - 9
Steel up to 400 N/mm <sup>2</sup>	mm	1,6
Steel up to 600 N/mm <sup>2</sup>	mm	1,2
Steel up to 800 N/mm <sup>2</sup>	mm	1
Non-ferrous metals up to 250 N/mm <sup>2</sup>	mm	2
Rad. of smallest curve	mm	15
Weight without storage battery	kg	1,4
<b>Part number</b>		<b>7 130 04 61 00 0</b>
<b>EAN</b>		<b>4014586886664</b>
<b>Price in € [PC01]</b>		<b>471,45</b>

**FEIN benefits:**

- ▶ Outstanding ergonomics through compact and simple construction for optimal mobility of the shears.
- ▶ Good curve precision with low sheet-metal distortion.
- ▶ Four-fold reversing blade for clean and burr-free cutting with low operating costs.
- ▶ MultiVolt interface. Cordless tool can be operated with all FEIN Li-ion batteries (12-18 V).
- ▶ Perfect for trimming and cutting.
- ▶ Unrestricted view of the cutting line.
- ▶ Proven MULTIMASTER motor with outstanding performance and stability.
- ▶ Cutting capacity with one battery charge: 140 m.
- ▶ Stainless steel up to 1.0 mm.

**Price includes:**

1 ABL 18 1.6 E, 1 pair of blades, 1 set of wrenches, 1 hand guard, 1 plastic carrying case

**ABLK 18 1.6 E Select**

Compact and curve-compatible nibbler for roof and façade construction. Precise cuts in trapezoid and corrugated sheet metals and profiles.

**FEIN SELECT<sup>+</sup>**For accessories, see page 51  
For mains variant of tool, see page 125

Battery voltage	V	18
Strokes	1/min	800 - 1 300
Cutting speed	m/min	1,5
Steel up to 400 N/mm <sup>2</sup>	mm	1,6
Steel up to 600 N/mm <sup>2</sup>	mm	1
Steel up to 800 N/mm <sup>2</sup>	mm	0,7
Non-ferrous metals up to 250 N/mm <sup>2</sup>	mm	2,5
Cutting width	mm	5
Immersion Ø with die	mm	22 mm
Rad. of smallest curve (inside/outside)	mm	30 / 35
Weight without storage battery	kg	1,65
<b>Part number</b>		<b>7 132 04 61 00 0</b>
<b>EAN</b>		<b>4014586886688</b>
<b>Price in € [PC01]</b>		<b>471,45</b>

**FEIN benefits:**

- ▶ 40 m of cutting in 0.8 mm trapezoid sheet metal with one battery.
- ▶ 1.5 m/min cutting speed for excellent work progress.
- ▶ Variable cutting speed due to electronically adjustable speed control.
- ▶ MultiVolt interface. Cordless tool can be operated with all FEIN Li-ion batteries (12-18 V).
- ▶ Brief overlapping area up to 2.6 mm.
- ▶ Optimum handling due to extremely slim gearbox head.
- ▶ Comfortably light weight.
- ▶ QuickIN quick change system for die and punch.
- ▶ Rotating punch for a service life which is now up to 30% longer.
- ▶ Cutting direction setting can be changed in 45° steps up to 360° using tool-free pivoting cutting head.
- ▶ Proven MULTIMASTER motor with outstanding performance and stability.
- ▶ Low operating costs. Punch and die are replaced independently of one another.

**Price includes:**

1 ABLK 1.6 E, 1 plastic carrying case

**ABLK 18 1.3 CSE Select**

**FEIN SELECT<sup>+</sup>**



For accessories, see page 51  
For mains variant of tool, see page 125

Compact and curve-compatible nibbler for roof and façade construction. Precise cuts in corrugated sheet metal up to 1.3 mm.

Battery voltage	V	18
Strokes	1/min	900 - 1 600
Cutting speed	m/min	1,9
Steel up to 400 N/mm <sup>2</sup>	mm	1,3
Steel up to 600 N/mm <sup>2</sup>	mm	0,8
Steel up to 800 N/mm <sup>2</sup>	mm	0,6
Non-ferrous metals up to 250 N/mm <sup>2</sup>	mm	2
Cutting width	mm	4
Immersion Ø with die	mm	19 mm
Rad. of smallest curve (inside/outside)	mm	15 / 20
Weight without storage battery	kg	1,6
<b>Part number</b>	<b>7 132 05 61 00 0</b>	
<b>EAN</b>	<b>4014586886701</b>	
<b>Price in € [PC01]</b>	<b>471,45</b>	

**FEIN benefits:**

- ▶ 40 m of cutting in 0.8 mm corrugated sheet metal with one battery.
- ▶ 1.9 m/min cutting speed for excellent work progress.
- ▶ Variable cutting speed due to electronically adjustable speed control.
- ▶ MultiVolt interface. Cordless tool can be operated with all FEIN Li-ion batteries (12-18 V).
- ▶ Brief overlapping area up to 2.6 mm.
- ▶ Optimum handling due to extremely slim gearbox head.
- ▶ Comfortably light weight.
- ▶ QuickIN quick change system for die and punch.
- ▶ Rotating punch for a service life which is now up to 30% longer.
- ▶ Cutting direction setting can be changed in 45° steps up to 360° using tool-free pivoting cutting head.
- ▶ Proven MULTIMASTER motor with outstanding performance and stability.

**Price includes:**

1 ABLK 18 1.3 CSE, 1 plastic carrying case

**ABLK 18 1.3 TE Select**

**FEIN SELECT<sup>+</sup>**



For accessories, see page 51  
For mains variant of tool, see page 125

Compact and curve-compatible nibbler for roof and façade construction. Precise cuts in trapezoid sheet metal up to 1.3 mm.

Battery voltage	V	18
Strokes	1/min	900 - 1 600
Cutting speed	m/min	1,9
Steel up to 400 N/mm <sup>2</sup>	mm	1,3
Steel up to 600 N/mm <sup>2</sup>	mm	0,8
Steel up to 800 N/mm <sup>2</sup>	mm	0,6
Non-ferrous metals up to 250 N/mm <sup>2</sup>	mm	2
Cutting width	mm	4
Immersion Ø with die	mm	19 mm
Rad. of smallest curve (inside/outside)	mm	25 / 30
Weight without storage battery	kg	1,6
<b>Part number</b>	<b>7 132 06 61 00 0</b>	
<b>EAN</b>	<b>4014586886725</b>	
<b>Price in € [PC01]</b>	<b>471,45</b>	

**FEIN benefits:**

- ▶ 40 m of cutting in 0.8 mm trapezoid sheet metal with one battery.
- ▶ 1.9 m/min cutting speed for excellent work progress.
- ▶ Variable cutting speed due to electronically adjustable speed control.
- ▶ MultiVolt interface. Cordless tool can be operated with all FEIN Li-ion batteries (12-18 V).
- ▶ Brief overlapping area up to 2.6 mm.
- ▶ Optimum handling due to extremely slim gearbox head.
- ▶ Comfortably light weight.
- ▶ QuickIN quick change system for die and punch.
- ▶ Rotating punch for a service life which is now up to 30% longer.
- ▶ Cutting direction setting can be changed in 45° steps up to 360° using tool-free pivoting cutting head.
- ▶ Proven MULTIMASTER motor with outstanding performance and stability.

**Price includes:**

1 ABLK 18 1.3 TE, 1 plastic carrying case



**General accessories**



**Tool case**  
Plastic, inner dimensions: 470 x 275 x 116 mm

Part number	Price in €
3 39 01 118 01 0	37,26



**Plastic box**  
Box insert with lockable lid for small parts and accessories, suitable for tool box 3 39 01 118 01 0, max 5 items/box.

Part number	Price in €
3 39 01 119 00 0	3,97



**Quick charger ALG 50**  
For all FEIN Li-ion batteries. Charge time from 35 min.

Part number	Price in €
9 26 04 129 01 0	40,95



**Quick charger ALG 30**  
For FEIN NiCd and Li-ion batteries. Charge time from 25 min.

Part number	Price in €
9 26 04 096 01 0	142,80



**Cutting paste**  
Lubricating agents for working on sheet metals.

Part number	Price in €
3 21 32 020 12 9	14,11

**18 V battery**



**Battery pack**  
Li-ion with charge status indicator and FEIN SafetyCell Technology. Protects the battery and tool from overload, overheating and total discharge.

Current/Voltages	Capacity	Part number	Price in €
V	Ah		
18	5	9 26 04 173 02 0	103,95
18	2,5	9 26 04 171 02 0	72,45



**Battery starter set**  
Very durable, light 18 V Li-ion batteries with innovative SafetyCell technology, 5 Ah capacity and charge indicator.

Part number	Price in €
9 26 04 300 03 0	248,85



**Battery starter set**  
Small and light 18 V Li-ion batteries with innovative SafetyCell technology, 2.5 Ah capacity and charge indicator.

Part number	Price in €
9 26 04 300 04 0	185,85

**Accessories for ABSS**

**Cutting bars**  
1 pair

Part number	Price in €
3 13 08 153 01 4	70,25

**Cutting blade**  
for stainless steel up to 800 N/mm<sup>2</sup>

Plate thickness mm	Part number	Price in €
0,8	3 13 08 152 00 1	78,47

**Blade for curves**  
for steel sheet up to 400 N/mm<sup>2</sup>

Plate thickness mm	Part number	Price in €
1	3 13 08 151 00 8	69,35

**Cutting blade**  
for steel sheet up to 400 N/mm<sup>2</sup>

Plate thickness mm	Part number	Price in €
1,6	3 13 08 150 00 9	65,26

**Accessories for ABLS**



**Plunger blade and fixed blade**  
for steel sheet up to 800 N/mm<sup>2</sup>

Part number	Price in €
3 13 08 072 00 0	26,99

**Accessories for ABLK 1.3 CSE**

**Die**  
for corrugated sheet metal

No. in pack pcs	Part number	Price in €
1	3 01 09 169 00 9	144,97
2	3 01 09 169 04 0	232,46

**Punches and dies in a set**  
consisting of 5 x punches 6 36 02 050 00 0 and 1 x die 3 01 09 169 00 9.

Part number	Price in €
3 01 09 169 03 0	183,18

**Accessories for ABLK 1.3 TE**

**Punches and dies in a set**  
consisting of 5 x punches 6 36 02 050 00 0 and 1 x die 3 01 09 170 00 1.

Part number	Price in €
3 01 09 170 03 0	200,33

**Die**  
for trapezoidal sheet metal

No. in pack pcs	Part number	Price in €
1	3 01 09 170 00 1	164,77
2	3 01 09 170 04 0	261,98

**Accessories for ABLK 1.6 E**



**Punch**

No. in pack pcs	Part number	Price in €
1	6 36 02 048 00 4	19,09
5	6 36 02 048 04 0	76,25
10	6 36 02 048 05 0	132,81



**Die**

No. in pack pcs	Part number	Price in €
1	3 01 09 141 00 3	48,70
2	3 01 09 141 02 0	77,50
5	3 01 09 141 03 0	169,73



**Punches and dies**

in set, each consisting of 1x punch 6 36 02 048 004 and 1x die 3 01 09 141 003.

Part number	Price in €
6 36 02 048 01 3	59,66



**Die holder**

for trapezoidal sheet metal and corrugated sheet metal

Part number	Price in €
3 01 09 154 00 7	192,84



**Profile set 160**

For deep-channel trapezoidal sheet metals (85-160 mm), incl. 1 punch, die and wearing plate.

Part number	Price in €
9 26 02 071 01 9	350,70

**Accessories for ABLK 1.3 CSE (TE)**



**Punch**

for steel sheet up to 400 N/mm<sup>2</sup>

Plate thickness mm	No. in pack pcs	Part number	Price in €
1,3	1	6 36 02 050 00 0	16,83
1,3	5	6 36 02 050 03 0	67,64
1,3	10	6 36 02 050 01 0	118,06



	<b>ABOP 6 Select</b>	<b>ABOP 10 Select</b>	<b>ABOP 13-2 Select</b>	<b>AWBP 10 Select</b>	
	Fast-running single-speed drill (battery-powered) with excellent speed stability, up to 6 mm in steel in metal construction.	Compact single-speed drill with speed stability (battery-powered), up to 10 mm in steel for on-site installation work.	Universal two-speed drill (battery-powered), up to 13 mm with ideal speed range for steel and stainless steel.	Extremely small cordless angle drill for working in difficult-to-reach spots.	
<b>Page</b>	54	54	55	55	
<b>Technical features</b>	Battery voltage	18 V	18 V	18 V	18 V
	Capacity in steel Ø	6 mm	10 mm	13 mm	10 mm
	capacity in Ø stainless steel	6 mm	10 mm	13 mm	10 mm
	Capacity in alu Ø	10 mm	15 mm	16 mm	15 mm
	Capacity in wood Ø	20 mm	30 mm	37 mm	25 mm
	Tapping		M 6	M 10	M 6
	Speed, full load	0 - 2 900 1/min	0 - 1 100 1/min	0 - 500 / 0 - 1 500 1/min	0 - 1 260 1/min
Weight without storage battery	1,4 kg	1,5 kg	1,7 kg	1,3 kg	

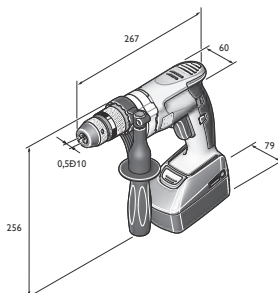

ABOP 6

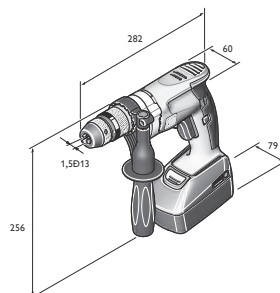

ABOP 10

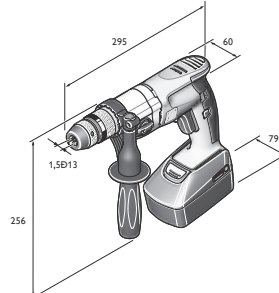

ABOP 13-2

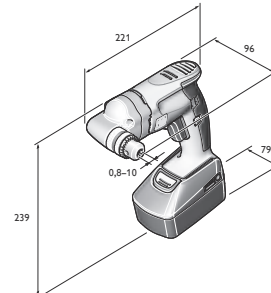

AWBP 10



**ABOP 6 Select****FEIN SELECT<sup>+</sup>**

For accessories, see page 56

For mains variant of tool, see page 62

Fast-running single-speed drill (battery-powered) with excellent speed stability, up to 6 mm in steel in metal construction.

Battery voltage	V	18
Speed, full load	1/min	0 - 2 900
Speed, no load	1/min	0 - 3 350
Torque	Nm	4
Stall torque	Nm	7
Drill chuck clamping width	mm	0,5 - 10
Capacity in steel Ø	mm	6
capacity in Ø stainless steel	mm	6
Capacity in alu Ø	mm	10
Capacity in wood Ø	mm	20
Thread of spindle		1/2"-20 UNF
Collar Ø	mm	43
Width across corners	mm	23
Weight without storage battery	kg	1,4
<b>Part number</b>		<b>7 105 01 62 00 0</b>
<b>EAN</b>		<b>4014586881744</b>
<b>Price in € [PC01]</b>		<b>261,45</b>

**FEIN benefits:**

- ▶ Outstanding quality battery-powered drill with high concentricity for precise drilling results.
- ▶ Brushless FEIN PowerDrive motor, fully encapsulated and dust-protected with 30% higher efficiency and long service life.
- ▶ Optimum speed for lower diameters and therefore economic working with efficient use of the machine.
- ▶ Metal gear head.
- ▶ High-precision metal drill chuck.
- ▶ Self-tightening drill chuck clamping jaws.
- ▶ Automatic spindle locking and single sheath quick clamping drill chuck.
- ▶ FEIN Sensitive Handle.
- ▶ Variable speed control.
- ▶ Reversible.
- ▶ Lithium ion storage battery with FEIN SafetyCell Technology. A separate communication cable protects the battery and tool from overload.
- ▶ 3-year FEIN PLUS warranty including battery and charger.

**Price includes:**

1 cordless drill, 1 SUPRA SKE single sheath metal quick clamping drill chuck, 1 additional handle, 1 plastic carrying case

**ABOP 10 Select****FEIN SELECT<sup>+</sup>**

For accessories, see page 56

For mains variant of tool, see page 62

Compact single-speed drill with speed stability (battery-powered), up to 10 mm in steel for on-site installation work.

Battery voltage	V	18
Speed, full load	1/min	0 - 1 100
Speed, no load	1/min	0 - 1 250
Torque	Nm	11
Stall torque	Nm	19
Drill chuck clamping width	mm	1,5 - 13
Capacity in steel Ø	mm	10
capacity in Ø stainless steel	mm	10
Capacity in alu Ø	mm	15
Capacity in wood Ø	mm	30
Tapping		M 6
Thread of spindle		1/2"-20 UNF
Collar Ø	mm	43
Width across corners	mm	23
Weight without storage battery	kg	1,5
<b>Part number</b>		<b>7 105 02 62 00 0</b>
<b>EAN</b>		<b>4014586881751</b>
<b>Price in € [PC01]</b>		<b>261,45</b>

**FEIN benefits:**

- ▶ Outstanding quality battery-powered drill with high concentricity for precise drilling results.
- ▶ Brushless FEIN PowerDrive motor, fully encapsulated and dust-protected with 30% higher efficiency and long service life.
- ▶ Particularly flat and slim design with excellent width across corners for installation work even in tight spaces and corners.
- ▶ Metal gear head.
- ▶ High-precision metal drill chuck.
- ▶ Self-tightening drill chuck clamping jaws.
- ▶ Automatic spindle locking and single sheath quick clamping drill chuck.
- ▶ FEIN Sensitive Handle.
- ▶ Variable speed control.
- ▶ Reversible.
- ▶ FEIN SafetyCell technology. Protects the battery and tool from overload, overheating and total discharge.
- ▶ 3-year FEIN PLUS warranty including battery and charger.

**Price includes:**

1 cordless drill, 1 SUPRA SKE single sheath metal quick clamping drill chuck, 1 additional handle, 1 plastic carrying case

**ABOP 13-2 Select**

Universal two-speed drill (battery-powered), up to 13 mm with ideal speed range for steel and stainless steel.

**FEIN SELECT<sup>+</sup>**

For accessories, see page 56

For mains variant of tool, see page 62

Battery voltage	V	18
Speed, full load	1/min	0 – 500 / 0 – 1 500
Speed, no load	1/min	0 – 580 / 0 – 1 760
Torque	Nm	24 / 8
Stall torque	Nm	39 / 13
Drill chuck clamping width	mm	1,5 - 13
Capacity in steel Ø	mm	13
capacity in Ø stainless steel	mm	13
Capacity in alu Ø	mm	16
Capacity in wood Ø	mm	37
Tapping		M 10
Thread of spindle		1/2"-20 UNF
Collar Ø	mm	43
Width across corners	mm	23
Weight without storage battery	kg	1,7

**Part number** 7 105 03 62 00 0**EAN** 4014586881768**Price in € [PC01]** 313,95**FEIN benefits:**

- ▶ Outstanding quality battery-powered drill with high concentricity for precise drilling results.
- ▶ Brushless FEIN PowerDrive motor, fully encapsulated and dust-protected with 30% higher efficiency and long service life.
- ▶ Mechanical two-speed gearbox for optimum speed adjustment for a wide range of uses.
- ▶ Metal gear head.
- ▶ High-precision metal drill chuck.
- ▶ Self-tightening drill chuck clamping jaws.
- ▶ Automatic spindle locking and single sheath quick clamping drill chuck.
- ▶ FEIN Sensitive Handle.
- ▶ Variable speed control.
- ▶ Reversible.
- ▶ FEIN SafetyCell technology. Protects the battery and tool from overload, overheating and total discharge.
- ▶ 3-year FEIN PLUS warranty including battery and charger.

**Price includes:**

1 cordless drill, 1 SUPRA SKE single sheath metal quick clamping drill chuck, 1 additional handle, 1 plastic carrying case

**AWBP 10 Select**

Extremely small cordless angle drill for working in difficult-to-reach spots.

**FEIN SELECT<sup>+</sup>**

For accessories, see page 56

For mains variant of tool, see page 62

Battery voltage	V	18
Speed, full load	1/min	0 - 1 260
Speed, no load	1/min	0 - 1 370
Torque	Nm	9,5
Stall torque	Nm	17
Drill chuck clamping width	mm	0,8 - 10
Capacity in steel Ø	mm	10
capacity in Ø stainless steel	mm	10
Capacity in alu Ø	mm	15
Capacity in wood Ø	mm	25
Tapping		M 6
Cone at drill shaft		B 10
Width across corners	mm	17
Weight without storage battery	kg	1,3

**Part number** 7 105 04 62 00 0**EAN** 4014586881775**Price in € [PC01]** 324,45**FEIN benefits:**

- ▶ Brushless FEIN PowerDrive motor, fully encapsulated and dust-protected with 30% higher efficiency and long service life.
- ▶ Particularly flat and slim design with 17 mm width across corners and 96 mm gearbox head height for work in tight spaces and corners.
- ▶ Flexible and universal use thanks to clockwise and reverse running for thread cuts up to M6.
- ▶ Metal gear head.
- ▶ Tapered drill shaft.
- ▶ High-precision metal drill chuck.
- ▶ High concentricity.
- ▶ FEIN Sensitive Handle.
- ▶ FEIN SafetyCell technology. Protects the battery and tool from overload, overheating and total discharge.
- ▶ 3-year FEIN PLUS warranty including battery and charger.

**Price includes:**

1 cordless angle drill, 1 3-jaw chuck up to Ø 10 mm, 1 drill chuck key, 1 plastic carrying case

**General accessories**



**Tool case**

With case insert and plastic box  
Plastic, inner dimensions: 470 x 275 x 116 mm

Part number	Price in €
3 39 01 131 08 0	46,99



**Quick charger ALG 50**

For all FEIN Li-ion batteries. Charge time from 35 min.

Part number	Price in €
9 26 04 129 01 0	40,95



**Quick charger ALG 30**

For FEIN NiCd and Li-ion batteries. Charge time from 25 min.

Part number	Price in €
9 26 04 096 01 0	142,80



**Battery pack**

Li-ion with charge status indicator and FEIN SafetyCell Technology. Protects the battery and tool from overload, overheating and total discharge.

Current/Voltages	Capacity	Part number	Price in €
V	Ah		
18	5	9 26 04 173 02 0	103,95
18	2,5	9 26 04 171 02 0	72,45



**Battery starter set**

Very durable, light 18 V Li-ion batteries with innovative SafetyCell technology, 5 Ah capacity and charge indicator.

Part number	Price in €
9 26 04 300 03 0	248,85



**Battery starter set**

Small and light 18 V Li-ion batteries with innovative SafetyCell technology, 2.5Ah capacity and charge indicator.

Part number	Price in €
9 26 04 300 04 0	185,85



**Suspension Device**

for hooking onto a balancer  
horizontal and vertical

Part number	Price in €
3 21 25 050 00 7	9,70

**Jaw spanner SW17**

Part number	Price in €
6 29 03 002 00 9	5,57



**Depth stop**

Part number	Price in €
3 21 27 005 00 6	5,45

**Accessories for ABOP 6**



**Quick-action chucks**

Single sheath metal SUPRA SKE quick clamping drill chuck with locking force safety device, drill chuck holder 1/2"-20 UNF

Chuck opening mm	Part number	Price in €
0.5 - 10	6 32 05 036 01 0	66,64

**Accessories for ABOP 10 (13-2)**



**Quick-action chucks**

Single sheath metal SUPRA SKE quick clamping drill chuck with locking force safety device, drill chuck holder 1/2"-20 UNF

Chuck opening mm	Part number	Price in €
1.5-13	6 32 05 035 01 0	69,07

**Accessories for AWBP 10**



**Tool case**

With case insert and plastic box

Part number	Price in €
3 39 01 131 94 0	44,73



**Key-type drill chucks**

Drill chuck holder B 10

Chuck opening mm	Weight kg	Part number	Price in €
0.5-8	0,14	6 32 02 043 01 0	28,98
0.8-10	0,22	6 32 02 044 01 8	31,93



## AGWP 10 Select

Fast, accurate thread drill with reversing gear for shorter working times.

FEIN SELECT<sup>+</sup>

For accessories, see page 58

For mains variant of tool, see page 76

Battery voltage	V	18
Idling speed in reverse running	1/min	0 - 760
Load speed when cutting	1/min	0 - 440
Load speed in reverse running	1/min	0 - 670
Torque	Nm	26
Stall torque	Nm	41
Thread in steel up to		M 10
Thread in stainless steel		M 10
Cone at drill shaft		B 12
Collar Ø	mm	43
Width across corners	mm	23
<b>Part number</b>		<b>7 109 01 62 00 0</b>
<b>EAN</b>		<b>4014586885537</b>
<b>Price in € [PC01]</b>		<b>408,45</b>

**FEIN benefits:**

- ▶ Unique speed thanks to reversing gear for automatic reversal of rotation direction when retracting drill spindle from threaded hole. Rapid return action at 670 rpm for shorter cycle times.
- ▶ Outstanding precision due to clearance-free connection of drill shaft and threaded chuck with B12 taper mounting for high concentricity. Positive fit of thread drill in chuck for the best results.
- ▶ FEIN sensitive handle for applying feed force in the direct drilling axis while ensuring an ideal position in the guiding hand.
- ▶ Brushless FEIN PowerDrive motor, fully encapsulated and dust-protected with 30% higher efficiency and long service life.
- ▶ Metal gear head.
- ▶ Small width across corners of 23 mm.
- ▶ FEIN SafetyCell technology. Protects the battery and tool from overload, overheating and total discharge.
- ▶ 3-year FEIN PLUS warranty including battery and charger.

**Price includes:**

1 cordless thread drill, **Threaded chuck not included**,  
1 additional handle, 1 plastic carrying case

## General accessories

**Quick charger ALG 50**

For all FEIN Li-ion batteries. Charge time from 35 min.

Part number	Price in €
9 26 04 129 01 0	40,95

**Quick charger ALG 30**

For FEIN NiCd and Li-ion batteries. Charge time from 25 min.

Part number	Price in €
9 26 04 096 01 0	142,80

**Battery pack**

Li-ion with charge status indicator and FEIN SafetyCell Technology. Protects the battery and tool from overload, overheating and total discharge.

Current/Voltages	Capacity	Part number	Price in €
V	Ah		
18	5	9 26 04 173 02 0	103,95
18	2,5	9 26 04 171 02 0	72,45

**Battery starter set**

Small and light 18 V Li-ion batteries with innovative SafetyCell technology, 2.5 Ah capacity and charge indicator.

Part number	Price in €
9 26 04 300 04 0	185,85

**Battery starter set**

Very durable, light 18 V Li-ion batteries with innovative SafetyCell technology, 5 Ah capacity and charge indicator.

Part number	Price in €
9 26 04 300 03 0	248,85

**Tool case**With case insert and plastic box  
Plastic, inner dimensions: 470 x 275 x 116 mm

Part number	Price in €
3 39 01 131 08 0	46,99

**Collet chuck**

with collets 3,5/4,5/6 mm

Part number	Price in €
6 32 06 063 01 2	81,83

**Floating collet chuck**

with collets 3,5/4,5/6 mm

Part number	Price in €
6 32 06 076 02 2	128,31

**Collets**for collets and floating collet chucks  
M2 (DIN 352, DIN 371), M4 (DIN 357, DIN 376)

Ø	Square	Part number	Price in €
mm	mm		
2,8	2,1	6 32 06 077 00 1	22,74

**Collets**for collets and floating collet chucks  
M3 (DIN 352, DIN 371), M5 (DIN 357, DIN 376)

Ø	Square	Part number	Price in €
mm	mm		
3,5	2,7	6 32 06 064 00 1	22,74

**Collets**for collets and floating collet chucks  
M4 (DIN 352, DIN 371), M6 (DIN 357, DIN 376)

Ø	Square	Part number	Price in €
mm	mm		
4,5	3,4	6 32 06 065 00 5	22,74

**Collets**for collets and floating collet chucks  
M5 (DIN 352, DIN 371), M6 (DIN 352), M7 (DIN 352),  
M8 (DIN 352, DIN 357, DIN 376)

Ø	Square	Part number	Price in €
mm	mm		
6	4,9	6 32 06 066 00 8	22,74

**Collets**for collets and floating collet chucks  
M7 (DIN 371), M9 (DIN 352) M 10 (DIN 352, DIN 357,  
DIN 376)

Ø	Square	Part number	Price in €
mm	mm		
7	5,5	6 32 06 070 00 6	22,74

**Collets**for collets and floating collet chucks  
M8 (DIN 371), M11 (DIN 352)

Ø	Square	Part number	Price in €
mm	mm		
8	6,2	6 32 06 078 00 9	22,74

**Collets**for collets and floating collet chucks  
M10 (DIN 371)

Ø	Square	Part number	Price in €
mm	mm		
10	8	6 32 06 079 00 3	22,09

**Collets**for collets and floating collet chucks  
M12 (DIN 357, DIN 371, DIN 376)

Ø	Square	Part number	Price in €
mm	mm		
9	7	6 32 06 075 00 4	22,74

**Jaw chuck**for tapping drill direct adaptor clamping range 2.8 - 9.0 mm,  
with key wrench

Part number	Price in €
6 32 06 019 00 9	83,40

**Floating jaw chuck**for tapping drill direct adaptor clamping range 2.8 - 9.0 mm,  
with key wrench

Part number	Price in €
6 32 06 041 00 8	123,11

**Drifts**

for drill chuck up to B12, length 125 mm, pack of 2

Mount	Length	Part number	Price in €
	mm		
B 12	125	6 33 05 009 01 3	27,66

**Depth stop**

Part number	Price in €
3 21 27 005 00 6	5,45



**SuperWire**

Reliable removal of glass without the need to reposition even with tight clearances.



For accessories, see page 59

Battery voltage	V	18
Battery capacity	Ah	3
Weight with battery	kg	6
<b>Part number</b>		<b>7 144 01 61 00 0</b>
<b>EAN</b>		<b>4014586872544</b>
<b>Price in € [PC01]</b>		<b>1.258,95</b>

**FEIN benefits:**

- ▶ Simple removal of glass without the need to reposition the SuperWire.
- ▶ Can even be used if the windscreen is very curved and with small gaps.
- ▶ High-strength round wire even cuts through double adhesive beads.
- ▶ Robust gearbox and motor unit with slipping clutch.
- ▶ Remove 40-60 panes with one battery charge.
- ▶ Brushless, maintenance-free motor.
- ▶ Remote control with LED lamp and 1.5 m cable.
- ▶ Slipping clutch prevents wire breakage.

**Price includes:**

1 battery pack (Li-ion), 1 rapid charger ALG 50, 2 PVC covers (dashboard + headliner), 300 m round wire, 10 metal skewers, 1 starter awl, Metal detector connection, 1 vacuum ring for very bent windscreens

**SuperWire**

(without battery or charger)

Reliable removal of glass without the need to reposition even with tight clearances.



For accessories, see page 59

Battery voltage	V	18
Battery capacity	Ah	3
<b>Part number</b>		<b>7 144 01 62 00 0</b>
<b>EAN</b>		<b>4014586872568</b>
<b>Price in € [PC01]</b>		<b>1.153,95</b>

**FEIN benefits:**

- ▶ Can even be used if the windscreen is very curved and with small gaps.
- ▶ Simple removal of glass without the need to reposition the SuperWire.
- ▶ High-strength round wire even cuts through double adhesive beads.
- ▶ Remote control with LED lamp and 1.5 m cable.
- ▶ Slipping clutch prevents wire breakage.
- ▶ Remove 40-60 panes with one battery charge.
- ▶ Brushless, maintenance-free motor.
- ▶ Robust gearbox and motor unit with slipping clutch.

**Price includes:**

1 vacuum ring for very bent windscreens, 1 starter awl, 300 m round wire, 10 metal skewers, 2 PVC covers (dashboard + headliner), Metal detector connection

**SuperWire**

**General accessories**



**Quick charger ALG 50**

For all FEIN Li-ion batteries. Charge time from 35 min.

Part number	Price in €
9 26 04 129 01 0	40,95



**Quick charger ALG 30**

For FEIN NiCd and Li-ion batteries. Charge time from 25 min.

Part number	Price in €
9 26 04 096 01 0	142,80



**Battery pack**

Li-ion with charge indicator

Current/Voltages	Capacity	Part number	Price in €
V	Ah		
18	4	9 26 04 165 02 0	155,40



**Cutting wire**

High-strength cutting wire, 300 metres, suitable for round wire systems.

Part number	Price in €
6 42 04 001 01 0	32,72



**Vacuum ring set**

To convert vacuum lifting pads, diameter 120 mm, for secure grip on curved windscreens.

Part number	Price in €
3 02 40 308 01 0	10,22



**Anti-Metal-Cut set**

Issues a warning signal if the wire touches the bodywork.

Part number	Price in €
6 42 04 002 01 0	18,07

**Extension-set**

Part number	Price in €
6 42 04 003 01 0	76,89



**Starter awl**

For pulling the wire into the interior.

Part number	Price in €
3 21 19 127 03 0	21,58

**Protective cover**

Small protective cover between vehicle panels and wire.

Part number	Price in €
3 21 74 013 20 0	18,94

**Protective cover**

Large protective cover between vehicle panels and wire.

Part number	Price in €
3 21 74 013 10 0	15,50



**Metal skewers**

To protect car body parts.

Part number	Price in €
3 02 29 347 01 0	4,94



**Anti-slip mat**

To protect car body parts.

Part number	Price in €
3 14 26 067 01 6	18,90





# We are the experts when it comes to drills. After all, we invented them.

In 1895 FEIN revolutionised manual work by inventing the first electric hand drill. Even today, FEIN drills bear the stamp of the same spirit of innovation: The best of 150 years of experience and always in enduring premium quality, whether drills, angle drills or thread drills. There are FEIN drills for almost any situation, with different sizes and shapes, drilling diameters of up to 38 mm and speeds adapted precisely to the material. These tools are perfectly tailored to the work you do, the standards you need to meet, and your way of working. Ergonomically shaped, lightweight, easy to operate and extremely durable, they are ideal for professional

users. The optimised range of accessories and special system components underline the expertise and experience that goes into a FEIN drill.



---

**Drills** **Page 62**  
Perfectly suited to the job. Precise, powerful, easy to use.



---

**Angle drills** **Page 72**  
Makes easy work of drilling round corners. Compact, versatile and powerful, for difficult or narrow locations.



---

**Magnetic drill jigs** **Page 73**  
Horizontal, vertical or overhead working: easy to use and flexible, on site or in the workshop.





---

**Tappers** **Page 76**  
Efficient, precise and reliable. The alternative to working by hand.

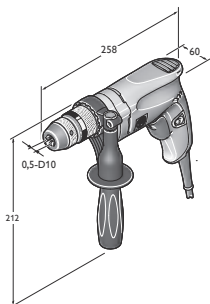

	<b>BOP 6</b>	<b>BOP 10</b>	<b>BOP 10-2</b>	<b>BOP 13-2</b>	<b>BOS 16</b>	
	Fast-running single-speed drill with good speed stability, up to 6 mm in steel in metal construction.	Compact single-speed drill with speed stability, up to 10 mm in steel for on-site installation work.	Universal two-speed drill, up to 10 mm with ideal speed range for steel and stainless steel.	Universal two-speed drill, up to 13 mm with ideal speed range for steel and stainless steel.	Powerful drill with speed setting for flexible use in metal construction.	
<b>Page</b>	64	65	66	67	68	
<b>Technical features</b>	Capacity in steel Ø	6 mm	10 mm	10 mm	13 mm	16 mm
	capacity in Ø stainless steel	6 mm	10 mm	10 mm	13 mm	16 mm
	Capacity in alu Ø	10 mm	15 mm	16 mm	16 mm	20 mm
	Capacity in wood Ø	20 mm	30 mm	35 mm	37 mm	50 mm
	Tapping		M 6	M 10	M 10	M 12
	Input	500 W	500 W	500 W	550 W	1 200 W
	Speed, full load	0 - 2 700 1/min	0 - 900 1/min	0 - 460 / 0 - 1 350 1/min	0 - 440 / 0 - 1 300 1/min	0 - 520 1/min
Weight according to EPTA	1,7 kg	1,8 kg	2 kg	2 kg	3,5 kg	



BOP 6

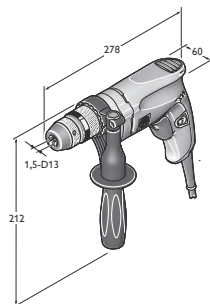

BOP 10

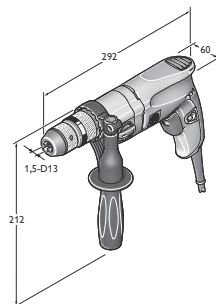

BOP 10-2

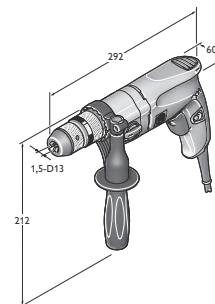

BOP 13-2

	<b>BOS 16-2</b>	<b>DSke 672</b>	<b>DDSk 672</b>	<b>DDSk 672-1</b>	<b>ASq 672-1</b>
	Powerful two-speed drill with speed setting for flexible use in metal construction.	Large two-speed drill with high torque.	Extremely robust four-speed rotary drill for heavy-duty drilling and reaming.	Universal four-speed rotary drill with reversible rotation and high drilling / tapping capacity.	Slow-speed drill and drive unit with very high torque.
	68	69	69	69	70
	16 mm	26 mm	32 mm	32 mm	38 mm
	16 mm	26 mm	32 mm	32 mm	38 mm
	20 mm	32 mm	40 mm	40 mm	
	50 mm	50 mm	60 mm	60 mm	
	M 12			M 20	M 30/R 1"
	1 200 W	1 050 W	1 050 W	900 W	900 W
	0 - 520 / 0 - 1 600 1/min	110 - 185 / 220 - 370 1/min	120 / 190 / 330 / 520 1/min	100 / 150 / 260 / 420 1/min	60 1/min
	3,7 kg	8,8 kg	9,4 kg	9,6 kg	10,6 kg

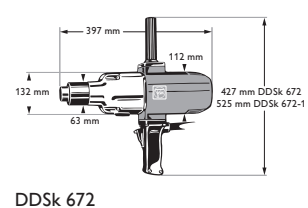
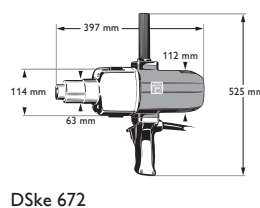
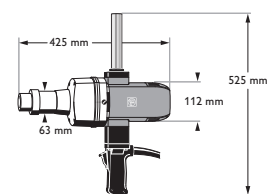
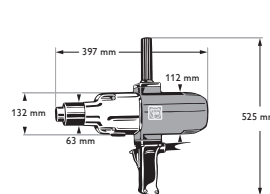
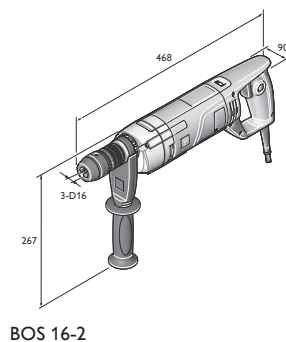
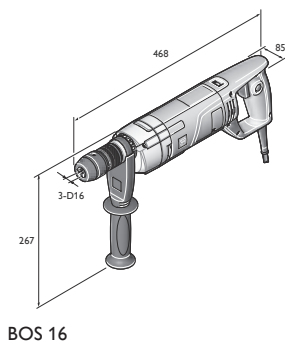

**BOP 6**

Fast-running single-speed drill with good speed stability, up to 6 mm in steel in metal construction.



For accessories, see page 70

Input	W	500
Output	W	270
Speed, full load	1/min	0 - 2 700
Speed, no load	1/min	0 - 4 000
Torque	Nm	3,5
Stall torque	Nm	9
Drill chuck clamping width	mm	0,5 - 10
Capacity in steel Ø	mm	6
capacity in Ø stainless steel	mm	6
Capacity in alu Ø	mm	10
Capacity in wood Ø	mm	20
Thread of spindle		1/2"-20 UNF
Collar Ø	mm	43
Width across corners	mm	23
Cable with plug	m	5
Weight according to EPTA	kg	1,7
<b>Part number</b>	<b>7 205 52 60 00 0</b>	
<b>EAN</b>	<b>4014586882413</b>	
<b>Price in € [PC01]</b>	<b>269,85</b>	

**FEIN benefits:**

- ▶ Powerful with optimum speed in lower diameter range for cost-effective working thanks to efficient tool use.
- ▶ Metal gear head and distortion-free barrel-type motor housing for superb service life.
- ▶ Automatic spindle lock and single-sheath quick clamping drill chuck for convenient tool changes.
- ▶ High-precision metal drill chuck.
- ▶ Self-tightening drill chuck clamping jaws.
- ▶ High concentricity.
- ▶ FEIN high-power motor.
- ▶ FEIN Sensitive Handle.
- ▶ Variable speed control.
- ▶ Reversible.
- ▶ 5 metre cable.

**Price includes:**

- 1 SUPRA SKE single sheath metal quick clamping drill chuck,
- 1 additional handle

**BOP 6**

Fast-running single-speed drill with good speed stability, up to 6 mm in steel in metal construction.



For accessories, see page 70

Input	W	500
Output	W	270
Speed, full load	1/min	0 - 2 700
Speed, no load	1/min	0 - 4 000
Torque	Nm	3,5
Stall torque	Nm	9
Drill chuck clamping width	mm	0,5 - 10
Capacity in steel Ø	mm	6
capacity in Ø stainless steel	mm	6
Capacity in alu Ø	mm	10
Capacity in wood Ø	mm	20
Thread of spindle		1/2"-20 UNF
Collar Ø	mm	43
Width across corners	mm	23
Cable with plug	m	5
Weight according to EPTA	kg	1,7
<b>Part number</b>	<b>7 205 52 61 00 0</b>	
<b>EAN</b>	<b>4014586881973</b>	
<b>Price in € [PC01]</b>	<b>292,95</b>	

**FEIN benefits:**

- ▶ Powerful with optimum speed in lower diameter range for cost-effective working thanks to efficient tool use.
- ▶ Metal gear head and distortion-free barrel-type motor housing for superb service life.
- ▶ Automatic spindle lock and single-sheath quick clamping drill chuck for convenient tool changes.
- ▶ High-precision metal drill chuck.
- ▶ Self-tightening drill chuck clamping jaws.
- ▶ High concentricity.
- ▶ FEIN high-power motor.
- ▶ FEIN Sensitive Handle.
- ▶ Variable speed control.
- ▶ Reversible.
- ▶ 5 metre cable.

**Price includes:**

- 1 SUPRA SKE single sheath metal quick clamping drill chuck,
- 1 plastic carrying case, 1 additional handle

**BOP 10**

Compact single-speed drill with speed stability, up to 10 mm in steel for on-site installation work.



For accessories, see page 70

Input	W	500
Output	W	270
Speed, full load	1/min	0 - 900
Speed, no load	1/min	0 - 1 500
Torque	Nm	9
Stall torque	Nm	24
Drill chuck clamping width	mm	1,5 - 13
Capacity in steel Ø	mm	10
capacity in Ø stainless steel	mm	10
Capacity in alu Ø	mm	15
Capacity in wood Ø	mm	30
Tapping		M 6
Thread of spindle		1/2"-20 UNF
Collar Ø	mm	43
Width across corners	mm	23
Cable with plug	m	5
Weight according to EPTA	kg	1,8
<b>Part number</b>		<b>7 205 53 60 00 0</b>
<b>EAN</b>		<b>4014586882468</b>
<b>Price in € [PC01]</b>		<b>269,85</b>

**FEIN benefits:**

- ▶ FEIN high-power motor with good speed stability for constant drilling progress in almost any application.
- ▶ Particularly flat and slim design with excellent width across corners for installation work even in tight spaces and corners.
- ▶ Automatic spindle lock and single-sheath quick clamping drill chuck for convenient tool changes.
- ▶ Metal gear head.
- ▶ Distortion-free barrel-type motor housing.
- ▶ High-precision metal drill chuck.
- ▶ Self-tightening drill chuck clamping jaws.
- ▶ High concentricity.
- ▶ FEIN Sensitive Handle.
- ▶ Variable speed control.
- ▶ Reversible.
- ▶ 5 metre cable.

**Price includes:**

- 1 SUPRA SKE single sheath metal quick clamping drill chuck,
- 1 additional handle

**BOP 10**

Compact single-speed drill with speed stability, up to 10 mm in steel for on-site installation work.



For accessories, see page 70

Input	W	500
Output	W	270
Speed, full load	1/min	0 - 900
Speed, no load	1/min	0 - 1 500
Torque	Nm	9
Stall torque	Nm	24
Drill chuck clamping width	mm	1,5 - 13
Capacity in steel Ø	mm	10
capacity in Ø stainless steel	mm	10
Capacity in alu Ø	mm	15
Capacity in wood Ø	mm	30
Tapping		M 6
Thread of spindle		1/2"-20 UNF
Collar Ø	mm	43
Width across corners	mm	23
Cable with plug	m	5
Weight according to EPTA	kg	1,8
<b>Part number</b>		<b>7 205 53 61 00 0</b>
<b>EAN</b>		<b>4014586881980</b>
<b>Price in € [PC01]</b>		<b>292,95</b>

**FEIN benefits:**

- ▶ FEIN high-power motor with good speed stability for constant drilling progress in almost any application.
- ▶ Particularly flat and slim design with excellent width across corners for installation work even in tight spaces and corners.
- ▶ Automatic spindle lock and single-sheath quick clamping drill chuck for convenient tool changes.
- ▶ Metal gear head.
- ▶ Distortion-free barrel-type motor housing.
- ▶ High-precision metal drill chuck.
- ▶ Self-tightening drill chuck clamping jaws.
- ▶ High concentricity.
- ▶ FEIN Sensitive Handle.
- ▶ Variable speed control.
- ▶ Reversible.
- ▶ 5 metre cable.

**Price includes:**

- 1 SUPRA SKE single sheath metal quick clamping drill chuck,
- 1 plastic carrying case, 1 additional handle



**BOP 10-2**

Universal two-speed drill, up to 10 mm with ideal speed range for steel and stainless steel.



For accessories, see page 70

Input	W	500
Output	W	270
Speed, full load	1/min	0 - 460 / 0 - 1 350
Speed, no load	1/min	0 - 700 / 0 - 2 250
Torque	Nm	20 / 7
Stall torque	Nm	50 / 16
Drill chuck clamping width	mm	1,5 - 13
Capacity in steel Ø	mm	10
capacity in Ø stainless steel	mm	10
Capacity in alu Ø	mm	16
Capacity in wood Ø	mm	35
Tapping		M 10
Thread of spindle		1/2"-20 UNF
Collar Ø	mm	43
Width across corners	mm	23
Cable with plug	m	5
Weight according to EPTA	kg	2
<b>Part number</b>		<b>7 205 54 60 00 0</b>
<b>EAN</b>		<b>4014586882512</b>
<b>Price in € [PC01]</b>		<b>328,65</b>

**FEIN benefits:**

- ▶ Mechanical two-speed gearbox for optimum speed adjustment for a wide range of uses.
- ▶ FEIN high-power motor with good speed stability for constant drilling progress in almost any application.
- ▶ Automatic spindle lock and single-sheath quick clamping drill chuck for convenient tool changes.
- ▶ Metal gear head.
- ▶ Distortion-free barrel-type motor housing.
- ▶ High-precision metal drill chuck.
- ▶ Self-tightening drill chuck clamping jaws.
- ▶ High concentricity.
- ▶ FEIN Sensitive Handle.
- ▶ Variable speed control.
- ▶ Reversible.
- ▶ 5 metre cable.

**Price includes:**

- 1 SUPRA SKE single sheath metal quick clamping drill chuck,
- 1 additional handle

**BOP 10-2**

Universal two-speed drill, up to 10 mm with ideal speed range for steel and stainless steel.



For accessories, see page 70

Input	W	500
Output	W	270
Speed, full load	1/min	0 - 460 / 0 - 1 350
Speed, no load	1/min	0 - 700 / 0 - 2 250
Torque	Nm	20 / 7
Stall torque	Nm	50 / 16
Drill chuck clamping width	mm	1,5 - 13
Capacity in steel Ø	mm	10
capacity in Ø stainless steel	mm	10
Capacity in alu Ø	mm	16
Capacity in wood Ø	mm	35
Tapping		M 10
Thread of spindle		1/2"-20 UNF
Collar Ø	mm	43
Width across corners	mm	23
Cable with plug	m	5
Weight according to EPTA	kg	2
<b>Part number</b>		<b>7 205 54 61 00 0</b>
<b>EAN</b>		<b>4014586881997</b>
<b>Price in € [PC01]</b>		<b>351,75</b>

**FEIN benefits:**

- ▶ Mechanical two-speed gearbox for optimum speed adjustment for a wide range of uses.
- ▶ FEIN high-power motor with good speed stability for constant drilling progress in almost any application.
- ▶ Automatic spindle lock and single-sheath quick clamping drill chuck for convenient tool changes.
- ▶ Metal gear head.
- ▶ Distortion-free barrel-type motor housing.
- ▶ High-precision metal drill chuck.
- ▶ Self-tightening drill chuck clamping jaws.
- ▶ High concentricity.
- ▶ FEIN Sensitive Handle.
- ▶ Variable speed control.
- ▶ Reversible.
- ▶ 5 metre cable.

**Price includes:**

- 1 SUPRA SKE single sheath metal quick clamping drill chuck,
- 1 additional handle, 1 plastic carrying case

**BOP 13-2**

Universal two-speed drill, up to 13 mm with ideal speed range for steel and stainless steel.



For accessories, see page 70

Input	W	550
Output	W	300
Speed, full load	1/min	0 - 440 / 0 - 1 300
Speed, no load	1/min	0 - 680 / 0 - 2 200
Torque	Nm	20 / 7
Stall torque	Nm	50 / 16
Drill chuck clamping width	mm	1,5 - 13
Capacity in steel Ø	mm	13
capacity in Ø stainless steel	mm	13
Capacity in alu Ø	mm	16
Capacity in wood Ø	mm	37
Tapping		M 10
Thread of spindle		1/2"-20 UNF
Collar Ø	mm	43
Width across corners	mm	23
Cable with plug	m	5
Weight according to EPTA	kg	2
<b>Part number</b>		<b>7 205 55 60 00 0</b>
<b>EAN</b>		<b>4014586882567</b>
<b>Price in € [PC01]</b>		<b>342,30</b>

**FEIN benefits:**

- ▶ FEIN high-power motor with good speed stability for constant drilling progress in almost any application.
- ▶ Mechanical two-speed gearbox for optimum speed adjustment for a wide range of uses.
- ▶ Automatic spindle lock and single-sheath quick clamping drill chuck for convenient tool changes.
- ▶ 5 metre cable.
- ▶ Variable speed control.
- ▶ FEIN Sensitive Handle.
- ▶ Metal gear head.
- ▶ High-precision metal drill chuck.
- ▶ Reversible.
- ▶ Distortion-free barrel-type motor housing.
- ▶ Self-tightening drill chuck clamping jaws.
- ▶ High concentricity.

**Price includes:**

- 1 SUPRA SKE single sheath metal quick clamping drill chuck,
- 1 additional handle

**BOP 13-2**

Universal two-speed drill, up to 13 mm with ideal speed range for steel and stainless steel.



For accessories, see page 70

Input	W	550
Output	W	300
Speed, full load	1/min	0 - 440 / 0 - 1 300
Speed, no load	1/min	0 - 680 / 0 - 2 200
Torque	Nm	20 / 7
Stall torque	Nm	50 / 16
Drill chuck clamping width	mm	1,5 - 13
Capacity in steel Ø	mm	13
capacity in Ø stainless steel	mm	13
Capacity in alu Ø	mm	16
Capacity in wood Ø	mm	37
Tapping		M 10
Thread of spindle		1/2"-20 UNF
Collar Ø	mm	43
Width across corners	mm	23
Cable with plug	m	5
Weight according to EPTA	kg	2
<b>Part number</b>		<b>7 205 55 61 00 0</b>
<b>EAN</b>		<b>4014586882017</b>
<b>Price in € [PC01]</b>		<b>368,55</b>

**FEIN benefits:**

- ▶ Mechanical two-speed gearbox for optimum speed adjustment for a wide range of uses.
- ▶ FEIN high-power motor with good speed stability for constant drilling progress in almost any application.
- ▶ Automatic spindle lock and single-sheath quick clamping drill chuck for convenient tool changes.
- ▶ Metal gear head.
- ▶ Distortion-free barrel-type motor housing.
- ▶ High-precision metal drill chuck.
- ▶ Self-tightening drill chuck clamping jaws.
- ▶ High concentricity.
- ▶ FEIN Sensitive Handle.
- ▶ Variable speed control.
- ▶ Reversible.
- ▶ 5 metre cable.

**Price includes:**

- 1 SUPRA SKE single sheath metal quick clamping drill chuck,
- 1 additional handle, 1 plastic carrying case

**BOS 16**

Powerful drill with speed setting for flexible use in metal construction.



For accessories, see page 70

Input	W	1 200
Output	W	680
Speed, full load	1/min	0 - 520
Speed, no load	1/min	0 - 520
Torque	Nm	50
Stall torque	Nm	50 **
Drill chuck clamping width	mm	3 - 16
Capacity in steel Ø	mm	16
capacity in Ø stainless steel	mm	16
Capacity in alu Ø	mm	20
Capacity in wood Ø	mm	50
Drilling diameter in steel, hole saws	mm	80
Tapping		M 12
Countersinking max. Ø	mm	31
Thread of spindle		1/2"-20 UNF
Collar Ø	mm	43
Width across corners	mm	27
Cable with plug	m	4
Weight according to EPTA	kg	3,5
<b>Part number</b>		<b>7 205 47 60 00 0</b>
<b>EAN</b>		<b>4014586874463</b>
<b>Price in € [PC01]</b>		<b>433,65</b>

**FEIN benefits:**

- ▶ Powerful 1 200 W motor with good speed stability for steady drilling progress.
- ▶ 6 electronic speed settings mean efficient and economic working at optimum speed.
- ▶ Flexible and universal use thanks to clockwise and reverse running for thread cuts up to M12.
- ▶ \*\* Torque slipping clutch.
- ▶ Metal gear head and distortion-free barrel-type motor housing for superb service life.
- ▶ Speed-controlled tacho electronics.
- ▶ High-precision metal drill chuck.
- ▶ Self-tightening drill chuck clamping jaws.
- ▶ High concentricity.
- ▶ Spade handle for optimum power transfer.
- ▶ Acceleration electronics for precise drilling.
- ▶ Collar for use with drill jig.

**Price includes:**

- 1 SUPRA SKE single sheath metal quick clamping drill chuck,
- 1 additional handle

**BOS 16-2**

Powerful two-speed drill with speed setting for flexible use in metal construction.



For accessories, see page 70

Input	W	1 200
Output	W	680
Speed, full load	1/min	0 - 520 / 0 - 1 600
Speed, no load	1/min	0 - 520 / 0 - 1 600
Torque	Nm	50 / 16
Stall torque	Nm	50 / 16 **
Drill chuck clamping width	mm	3 - 16
Capacity in steel Ø	mm	16
capacity in Ø stainless steel	mm	16
Capacity in alu Ø	mm	20
Capacity in wood Ø	mm	50
Drilling diameter in steel, hole saws	mm	80
Tapping		M 12
Countersinking max. Ø	mm	31
Thread of spindle		1/2"-20 UNF
Collar Ø	mm	43
Width across corners	mm	27
Cable with plug	m	4
Weight according to EPTA	kg	3,7
<b>Part number</b>		<b>7 205 49 60 00 0</b>
<b>EAN</b>		<b>4014586876443</b>
<b>Price in € [PC01]</b>		<b>499,80</b>

**FEIN benefits:**

- ▶ Powerful 1 200 W motor with good speed stability for steady drilling progress.
- ▶ Mechanical two-speed gearbox for optimum speed adjustment for a wide range of uses.
- ▶ Reversible rotation.
- ▶ \*\* Torque slipping clutch.
- ▶ Metal gear head and distortion-free barrel-type motor housing for superb service life.
- ▶ Speed-controlled tacho electronics.
- ▶ High-precision metal drill chuck.
- ▶ Self-tightening drill chuck clamping jaws.
- ▶ High concentricity.
- ▶ Spade handle for optimum power transfer.
- ▶ Acceleration electronics for precise drilling.
- ▶ Collar for use with drill jig.

**Price includes:**

- 1 SUPRA SKE single sheath metal quick clamping drill chuck,
- 1 additional handle

**DSke 672**

Large two-speed drill with high torque.



For accessories, see page 70

Input	W	1 050
Output	W	650
Speed, full load	1/min	110 - 185 / 220 - 370
Speed, no load	1/min	120 - 270 / 240 - 540
Capacity in steel Ø	mm	26
capacity in Ø stainless steel	mm	26
Capacity in alu Ø	mm	32
Capacity in wood Ø	mm	50
Cone at drill shaft		MK 3
Collar Ø	mm	63
Width across corners	mm	41
Cable with plug	m	2,5
Weight according to EPTA	kg	8,8
<b>Part number</b>		<b>7 202 09 00 22 7</b>
<b>EAN</b>		<b>4014586802855</b>
<b>Price in € [PC01]</b>		<b>1.262,10</b>

**FEIN benefits:**

- ▶ Mechanical two-speed indexing gear with ideal transmission for high torques.
- ▶ Electronic speed control for constant cutting speed, enabling efficient and economic working.
- ▶ MT 3 holder for flexible tool use with high concentricity for optimum results.
- ▶ Speed preselection.
- ▶ Metal gear head.
- ▶ Cross handle.
- ▶ Superb service life.
- ▶ For optimum use on FEIN magnetic drill jigs.
- ▶ Wide range of accessories.

**Price includes:**

1 additional handle, 1 drift key

**DDSk 672**

Extremely robust four-speed rotary drill for heavy-duty drilling and reaming.



For accessories, see page 70

Input	W	1 050
Output	W	650
Speed, full load	1/min	120 / 190 / 330 / 520
Speed, no load	1/min	175 / 280 / 480 / 760
Capacity in steel Ø	mm	32
capacity in Ø stainless steel	mm	32
Capacity in alu Ø	mm	40
Capacity in wood Ø	mm	60
Cone at drill shaft		MK 3
Collar Ø	mm	63
Width across corners	mm	41
Cable with plug	m	2,5
Weight according to EPTA	kg	9,4
<b>Part number</b>		<b>7 202 06 00 22 9</b>
<b>EAN</b>		<b>4014586802749</b>
<b>Price in € [PC01]</b>		<b>1.487,85</b>

**FEIN benefits:**

- ▶ Mechanical four-speed indexing gear with ideal speed grading for high torques.
- ▶ MT 3 holder for flexible tool use with high concentricity for optimum results.
- ▶ Robust design with metal gear head for maximum operating demands and superb service life.
- ▶ Cross handle.
- ▶ For optimum use on FEIN magnetic drill jigs.
- ▶ Wide range of accessories.

**Price includes:**

1 additional handle, 1 drift key

**DDSk 672-1**

Universal four-speed rotary drill with reversible rotation and high drilling / tapping capacity.



For accessories, see page 70

Input	W	900
Output	W	500
Speed, full load	1/min	100 / 150 / 260 / 420
Speed, no load	1/min	170 / 250 / 450 / 700
Capacity in steel Ø	mm	32
capacity in Ø stainless steel	mm	32
Capacity in alu Ø	mm	40
Capacity in wood Ø	mm	60
Tapping		M 20
Cone at drill shaft		MK 3
Collar Ø	mm	63
Width across corners	mm	41
Cable with plug	m	2,5
Weight according to EPTA	kg	9,6
<b>Part number</b>		<b>7 205 01 00 22 8</b>
<b>EAN</b>		<b>4014586804453</b>
<b>Price in € [PC01]</b>		<b>1.534,05</b>

**FEIN benefits:**

- ▶ MT 3 holder for flexible tool use with high concentricity for optimum results.
- ▶ Mechanical four-speed indexing gear with ideal speed grading for high torques.
- ▶ Reversible rotation for thread cuts of up to M 20 in stationary operation with FEIN magnetic drill jigs.
- ▶ Able to handle extreme loads.
- ▶ Metal gear head.
- ▶ Cross handle.
- ▶ Superb service life.
- ▶ For optimum use on FEIN magnetic drill jigs.
- ▶ Wide range of accessories.

**Price includes:**

1 additional handle, 1 drift key

**ASq 672-1**

Slow-speed drill and drive unit with very high torque.



For accessories, see page 70

Input	W	900
Output	W	500
Speed, full load	1/min	60
Speed, no load	1/min	100
Capacity in steel Ø	mm	38
capacity in Ø stainless steel	mm	38
Reaming	mm	40
Tube expanding Ø	mm	65
Tapping		M 30/R 1"
Cone at drill shaft		M.T. 4
Cable with plug	m	2,5
Weight according to EPTA	kg	10,6
<b>Part number</b>		<b>7 205 03 00 22 0</b>
<b>EAN</b>		<b>4014586804569</b>
<b>Price in € [PC01]</b>		<b>1.733,55</b>

**FEIN benefits:**

- ▶ Extremely high torque for driving rollers, spindles, regulators etc.
- ▶ MT 4 holder for flexible tool use with high concentricity for optimum results.
- ▶ Reversible rotation for thread cuts of up to M 30 in stationary operation with FEIN magnetic drill jigs.
- ▶ Metal gear head.
- ▶ Cross handle.
- ▶ Superb service life.
- ▶ For optimum use on FEIN magnetic drill jigs.
- ▶ Wide range of accessories.

**Price includes:**

1 additional handle, 1 drift key, 1 suspension eyelet

**Drills**

**Accessories for BOP 6, BOP 10, BOP 10-2, BOP 13-2**



**Tool case**

With case insert and plastic box  
Plastic, inner dimensions: 470 x 275 x 116 mm

Part number	Price in €
3 39 01 118 48 0	48,95



**Quick-action chucks**

Single sheath metal SUPRA SKE quick clamping drill chuck with locking force safety device, drill chuck holder 1/2"-20 UNF

Chuck opening mm	Part number	Price in €
0.5 - 10	6 32 05 036 01 0	66,64



**Quick-action chucks**

Single sheath metal SUPRA SKE quick clamping drill chuck with locking force safety device, drill chuck holder 1/2"-20 UNF

Chuck opening mm	Part number	Price in €
1.5-13	6 32 05 035 01 0	69,07

**Jaw spanner SW17**

Part number	Price in €
6 29 03 002 00 9	5,57

**Suspension Device**

for hooking onto a balancer  
vertical

Part number	Price in €
3 02 32 046 00 8	2,34



**Suspension Device**

for hooking onto a balancer  
horizontal and vertical

Part number	Price in €
3 21 25 050 00 7	9,70



**Depth stop**

Part number	Price in €
3 21 27 005 00 6	5,45

**Protective cover**

for protecting the work piece surface from mechanical damages

Model	Part number	Price in €
BOP 10	3 14 20 131 01 0	11,68
BOP 10-2/13-2	3 14 20 132 01 0	11,68



**Cutting paste**

Lubricating agents for working on sheet metals.

Part number	Price in €
3 21 32 020 12 9	14,11

**Accessories for BOS 16, BOS 16-2**



**Tool case**

Metal

Width mm	Length mm	Height mm	Part number	Price in €
240	690	160	3 39 01 022 01 4	47,78



**Paddle**

Length 600 mm, Ø 110 mm

Part number	Price in €
6 39 02 002 01 3	80,38



**Quick-action chucks**

Single sheath metal SUPRA SKE quick clamping drill chuck with locking force safety device, drill chuck holder 1/2"-20 UNF

Chuck opening mm	Weight kg	Part number	Price in €
3-16	0,56	6 32 05 038 01 0	101,52

**Quick-action chucks**Drill chuck holder 1/2"-20 UNF  
form R tip

Chuck opening mm	Weight kg	Part number	Price in €
1-13	0,54	6 32 05 033 01 0	81,19

**Key-type drill chucks**

Drill chuck holder 1/2"-20 UNF

Chuck opening mm	Weight kg	Part number	Price in €
1-10	0,3	6 32 03 034 01 0	30,52
1.5-13	0,38	6 32 03 041 01 4	39,09

**Accessories for DSke 672, DDSk 671-1, DDSk 672****Tool case**

metal 400 x 400 x 130 mm

Part number	Price in €
3 39 01 032 01 3	49,27

**Quick-action chucks**Drill chuck holder B 16  
form R tip

Chuck opening mm	Weight kg	Part number	Price in €
0-10	0,61	6 32 04 016 00 7	62,88
1-13	0,88	6 32 04 017 00 1	74,57
3-16	1,14	6 32 04 025 00 3	87,87

**Quick-action chucks**Drill chuck holder B 16  
R shaped tip with locking force safety device

Chuck opening mm	Weight kg	Part number	Price in €
1-13	0,56	6 32 04 032 00 6	80,06

**Key-type drill chucks**

Drill chuck holder B 16

Chuck opening mm	Weight kg	Part number	Price in €
1.5-13	0,41	6 32 02 030 01 5	42,28
1-16	0,64	6 32 02 037 01 0	59,61

**Morse taper arbors**

for drilling machines with morse taper arbor

Mount	Part number	Price in €
MT 3/B 16	6 33 01 012 00 5	12,14
MT 3/B 22	6 33 01 014 00 7	16,52

**Enlargement tapers**

for M.T. sockets

Mount	Part number	Price in €
MT 3/MT 4	6 33 04 004 00 0	95,14

**Reducing sleeves**

for M.T. sockets

Part number	Price in €
6 33 02 003 00 4	14,50

**Drift keys**

Mount	Length mm	Part number	Price in €
MT 1/MT 2	140	6 33 05 003 00 3	5,81
MT 3/MT 4	190	6 33 05 004 00 1	5,92

**Accessories for ASq 672-1****Key-type drill chucks**

Drill chuck holder B 22

Chuck opening mm	Outer Ø mm	Drill chuck holder	Weight kg	Part number	Price in €
5-20	75	B 22	1,55	6 32 02 022 01 8	96,78

**Morse taper arbors**

for drilling machines with morse taper arbor

Mount	Part number	Price in €
MT 4/B 22	6 33 01 016 00 4	32,19

**Reducing sleeves**

for M.T. sockets

Mount	Part number	Price in €
MT 4/MT 3	6 33 02 004 00 2	21,33

**Accessories for ASq 672-1, DSke 672, DDSk 672-1, DDSk 672****Safety slipping clutch**with MT 3 -socket and output Ø 30 mm, adjusting range  
15-80 Nm for speed range 0-500 rpm., weight 2,2 kg,  
incl. rubber ring, cylindrical pin, clamping sleeve and hook spanner

Part number	Price in €
9 01 05 002 01 8	976,75



## WBP 10

Extremely small angle drill for working in difficult-to-reach spots.



For accessories, see page 72  
For cordless variant of tool, see page 53

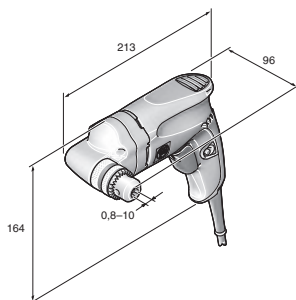

WBP 10

Input	W	500
Output	W	270
Speed, full load	1/min	0 - 1 030
Speed, no load	1/min	0 - 1 830
Torque	Nm	8
Stall torque	Nm	21
Drill chuck clamping width	mm	0,8 - 10
Capacity in steel Ø	mm	10
capacity in Ø stainless steel	mm	10
Capacity in alu Ø	mm	15
Capacity in wood Ø	mm	25
Tapping		M 6
Cone at drill shaft		B 10
Width across corners	mm	17
Cable with plug	m	5
Weight according to EPTA	kg	1,5
<b>Part number</b>		<b>7 205 51 60 00 0</b>
<b>EAN</b>		<b>4014586878843</b>
<b>Price in € [PC01]</b>		<b>326,55</b>

### FEIN benefits:

- ▶ FEIN high-power motor with good speed stability for constant drilling progress in almost any application.
- ▶ Particularly flat and slim design with 17 mm width across corners and 96 mm gearbox head height for work in tight spaces and corners.
- ▶ Flexible and universal use thanks to clockwise and reverse running for thread cuts up to M6.
- ▶ Metal gear head.
- ▶ Tapered drill shaft.
- ▶ High-precision metal drill chuck.
- ▶ High concentricity.
- ▶ Distortion-free barrel-type motor housing.
- ▶ FEIN Sensitive Handle.
- ▶ 5 metre cable.

### Price includes:

1 3-jaw chuck up to Ø 10 mm, 1 drill chuck key

## Angle drills

### Accessories for WBP 10



#### Tool case

Plastic, inner dimensions: 470 x 275 x 116 mm

Part number	Price in €
3 39 01 118 01 0	37,26



#### Plastic box

Box insert with lockable lid for small parts and accessories, suitable for tool box 3 39 01 118 01 0, max 5 items/box.

Part number	Price in €
3 39 01 119 00 0	3,97



### Key-type drill chucks

Drill chuck holder B 10

Chuck opening mm	Weight kg	Part number	Price in €
0,5-8	0,14	6 32 02 043 01 0	28,98
0,8-10	0,22	6 32 02 044 01 8	31,93



	IBS 16	MBS 16 X	MBS 25 F	MBS 32 F	
	Industrial drill jig for drills with drilling capacity of up to 16 mm.	Flexible magnetic drill jig for rotary drills with up to 16 mm drill capacity.	Flexible magnetic drill jig for rotary drills with up to 25 mm drill capacity.	Flexible magnetic drill jig with fine adjustment for rotary drills with up to 32 mm drill capacity.	
<b>Page</b>	74	74	74	75	
<b>Technical features</b>	Twist drill max. Ø	16 mm	16 mm	25 mm	32 mm
	Reaming max. Ø	16 mm	16 mm	25 mm	40 mm
	Swivel range for drill jigs			7°	350°
	Adjustment range for drill jigs			6 mm	10 mm
	Tapping	M 12	M 12	M 20	M 24
	For collar Ø	53 mm	43 mm	53 mm	63 mm
	Stroke	145 mm	145 mm	145 mm	178 mm
	Total stroke range	295 mm	325 mm	290 mm	365 mm
	Magnetic foot dimensions		195 x 90 mm	205 x 95 mm	220 x 100 mm
	Magnetic holding power		12 500 N	14 000 N	18 000 N
Weight according to EPTA	8 kg	9,5 kg	12,5 kg	21,8 kg	

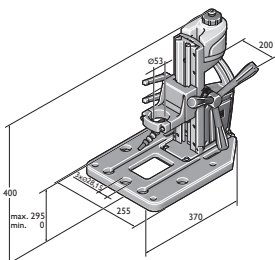

IBS 16

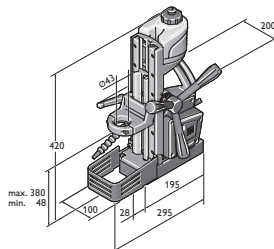

MBS 16 X

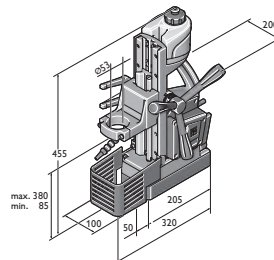

MBS 25 F

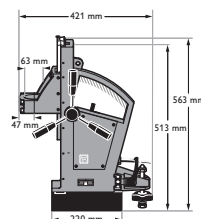

MBS 32 F

**IBS 16**

Industrial drill jig for drills with drilling capacity of up to 16 mm.



For collar Ø	mm	53
Twist drill max. Ø	mm	16
Tapping		M 12
Countersinking max. Ø	mm	50
Reaming max. Ø	mm	16
Stroke	mm	145
Total stroke range	mm	295
Weight according to EPTA	kg	8
<b>Part number</b>		<b>9 03 20 223 00 0</b>
<b>EAN</b>		<b>4014586878515</b>
<b>Price in € [PC01]</b>		<b>435,75</b>

**FEIN benefits:**

- ▶ Lightweight, compact industrial drill jig with aluminium base plate for universal use, including drilling, tapping, reaming and countersinking.
- ▶ Double drill motor guide for use with very large drilling tools.
- ▶ Base plate with hole pattern for Demmeler and Siegmund System 28 welding tables.
- ▶ Integrated coolant tank with flexible jointed hose.
- ▶ Feed handwheel can be moved from one side to the other.
- ▶ Carriage height adjustable without tools.

**Price includes:**

1 coolant tank, 1 flex-jointed hose, 1 reducing ring, diameter 43 mm

For accessories, see page 75

**MBS 16 X**

Flexible magnetic drill jig for rotary drills with up to 16 mm drill capacity.



Input	W	100
Socket max.	A	16
For collar Ø	mm	43
Twist drill max. Ø	mm	16
Tapping		M 12
Countersinking max. Ø	mm	50
Reaming max. Ø	mm	16
Stroke	mm	145
Total stroke range	mm	325
Magnetic holding power	N	12 500
Magnetic foot dimensions	mm	195 x 90
Cable with plug	m	4
Weight according to EPTA	kg	9,5
<b>Part number</b>		<b>9 03 18 223 00 0</b>
<b>EAN</b>		<b>4014586878034</b>
<b>Price in € [PC01]</b>		<b>927,15</b>

**FEIN benefits:**

- ▶ Lightweight, compact magnetic drill jig for universal use, including drilling, tapping, reaming and countersinking.
- ▶ Double drill motor guide for use with very large drilling tools.
- ▶ High magnetic holding power and safety circuit guarantee safe working in any position.
- ▶ Integrated coolant tank with flexible jointed hose.
- ▶ Feed handwheel can be moved from one side to the other.
- ▶ Carriage height adjustable without tools.

**Price includes:**

1 coolant tank, 1 lashing strap, 1 contact guard

For accessories, see page 75

**MBS 25 F**

Flexible magnetic drill jig for rotary drills with up to 25 mm drill capacity.



Input	W	100
Socket max.	A	16
For collar Ø	mm	53
Twist drill max. Ø	mm	25
Tapping		M 20
Countersinking max. Ø	mm	50
Reaming max. Ø	mm	25
Stroke	mm	145
Total stroke range	mm	290
Adjustment range for drill jigs	mm	6
Swivel range for drill jigs		7°
Magnetic holding power	N	14 000
Magnetic foot dimensions	mm	205 x 95
Cable with plug	m	4
Weight according to EPTA	kg	12,5
<b>Part number</b>		<b>9 03 19 223 00 0</b>
<b>EAN</b>		<b>4014586878041</b>
<b>Price in € [PC01]</b>		<b>1.309,35</b>

**FEIN benefits:**

- ▶ Universal suitability for drilling, tapping, reaming and countersinking.
- ▶ Fine adjustment of the drill spindle for convenient tool alignment.
- ▶ Double drill motor guide for use with very large drilling tools.
- ▶ Feed handwheel can be moved from one side to the other.
- ▶ Integrated coolant tank with flexible jointed hose.
- ▶ High magnetic holding force.
- ▶ Carriage height adjustable without tools.

**Price includes:**

1 coolant tank, 1 lashing strap, 1 contact guard, 1 reducing ring, diameter 43 mm

For accessories, see page 75



**MBS 32 F**

Flexible magnetic drill jig with fine adjustment for rotary drills with up to 32 mm drill capacity.



For accessories, see page 75

Input	W	130
Socket max.	A	16
For collar Ø	mm	63
Twist drill max. Ø	mm	32
Tapping		M 24
Reaming max. Ø	mm	40
Stroke	mm	178
Total stroke range	mm	365
Adjustment range for drill jigs	mm	10
Swivel range for drill jigs		350°
Magnetic holding power	N	18 000
Magnetic foot dimensions	mm	220 x 100
Cable with plug	m	4
Weight according to EPTA	kg	21,8
<b>Part number</b>		<b>9 03 16 223 00 8</b>
<b>EAN</b>		<b>4014586847924</b>
<b>Price in € [PC01]</b>		<b>2.462,25</b>

**FEIN benefits:**

- ▶ Universal suitability for drilling, tapping, reaming and countersinking.
- ▶ Fine adjustment of drill spindle for easy alignment of machine without constantly removing and refitting the magnet.
- ▶ High magnetic holding power and safety circuit guarantee safe working in any position.
- ▶ Infinitely variable stroke range setting.
- ▶ Compact design.
- ▶ Optimum power-to-weight ratio.
- ▶ Robust and accurate dual dove-tail guide
- ▶ Universal use for drive machines with clamping collar.

**Price includes:**

1 clamping strap, 1 swarf hook, 1 swarf guard, 2 keys

**Magnetic drill jigs**

**Accessories for IBS 16**



**Reducing rings**  
for attaching machines with collar Ø 43 mm  
FEIN BOS, KBH

mm	Part number	Price in €
53 / 43	3 26 23 014 01 0	32,77

**Prism vice**

Part number	Price in €
9 07 01 002 01 0	103,95

**Vice installation kit**

Part number	Price in €
6 41 31 019 01 0	26,15

**Adapter plate for magnetic core drills**

Part number	Price in €
3 24 22 326 01 0	42,61

**Accessories for MBS 16 X**



**Reducing rings**  
for attaching machines with collar Ø 33 mm.

mm	Part number	Price in €
43 / 33	3 26 23 012 01 9	32,77



**Reducing rings**  
for attaching machines with collar Ø 38 mm

mm	Part number	Price in €
43 / 38	3 26 23 013 00 4	32,77

**Accessories for MBS 25 F**



**Reducing rings**  
for attaching machines with collar Ø 38 mm

mm	Part number	Price in €
53 / 38	3 26 23 010 00 8	32,77



**Reducing rings**

for attaching machines with collar Ø 43 mm

mm	Part number	Price in €
53 / 43	3 26 23 009 00 6	32,77



**Reducing rings**

for attaching machines with collar Ø 43 mm  
FEIN BOS, KBH

mm	Part number	Price in €
53 / 43	3 26 23 014 01 0	32,77

**Accessories for MBS 16 X, MBS 25 F, MBS 32 F**



**Suction plate**

for anti-magnetic materials, 250 x 330 x 110 mm

Part number	Price in €
9 26 02 054 01 6	465,89



**Vacuum plate**

for anti-magnetic materials and structured bases  
(corrugated sheet, stud plate etc.)  
Vacuum plate 396 x 200 x 95 mm

Part number	Price in €
9 26 02 057 01 7	484,09



**Pipe drilling device**

incl. clamping strap, for positioning bores on pipes with pipe Ø of 60 to 300 mm, 220 x 130 mm.

Part number	Price in €
9 26 02 055 01 0	253,83



**Vacuum pump**

Suction rate 0,015 m³/min, -0,8 bar, 92 W, weight 2,5 kg including suction hose

Part number	Price in €
9 26 01 022 01 3	499,09

**GWP 10**

Fast, accurate thread drill with reversing gear for shorter working times.



For accessories, see page 77  
For cordless variant of tool, see page 57

Input	W	450
Output	W	250
Idling speed in reverse running	1/min	0 - 1 000
Load speed when cutting	1/min	0 - 450
Load speed in reverse running	1/min	0 - 680
Torque	Nm	21
Stall torque	Nm	53
Thread in steel up to		M 10
Thread in stainless steel		M 10
Cone at drill shaft		B 12
Collar Ø	mm	43
Width across corners	mm	23
Cable with plug	m	5
Weight according to EPTA	kg	1,6
<b>Part number</b>		<b>7 209 38 60 00 0</b>
<b>EAN</b>		<b>4014586881256</b>
<b>Price in € [PC01]</b>		<b>598,50</b>

**FEIN benefits:**

- ▶ Unique speed thanks to reversing gear for automatic reversal of rotation direction when retracting drill spindle from threaded hole. Rapid return action at 680 rpm for shorter cycle times.
- ▶ Outstanding precision due to clearance-free connection of drill shaft and threaded chuck with B12 taper mounting for high concentricity. Positive fit of thread drill in chuck for the best results.
- ▶ FEIN sensitive handle for applying feed force in the direct drilling axis while ensuring an ideal position in the guiding hand.
- ▶ FEIN high-power motor with stable speed.
- ▶ Small width across corners of 23 mm.
- ▶ Metal gear head.
- ▶ Distortion-free barrel-type motor housing.

**Price includes:**

1 additional handle, **Threaded chuck not included**

**General accessories****Plastic box**

Box insert with lockable lid for small parts and accessories, suitable for tool box 3 39 01 118 01 0, max 5 items/box.

Part number	Price in €
3 39 01 119 00 0	3,97

**Tool case**

Plastic, inner dimensions: 470 x 275 x 116 mm

Part number	Price in €
3 39 01 118 01 0	37,26

**Cutting paste**

Lubricating agents for working on sheet metals.

Part number	Price in €
3 21 32 020 12 9	14,11

**Accessories for GWP 10****Collet chuck**

with collets 3,5/4,5/6 mm

Part number	Price in €
6 32 06 063 01 2	81,83

**Floating collet chuck**

with collets 3,5/4,5/6 mm

Part number	Price in €
6 32 06 076 02 2	128,31

**Collets**

for collets and floating collet chucks  
M2 (DIN 352, DIN 371), M4 (DIN 357, DIN 376)

Ø mm	Square mm	Part number	Price in €
2,8	2,1	6 32 06 077 00 1	22,74

**Collets**

for collets and floating collet chucks  
M3 (DIN 352, DIN 371), M5 (DIN 357, DIN 376)

Ø mm	Square mm	Part number	Price in €
3,5	2,7	6 32 06 064 00 1	22,74

**Collets**

for collets and floating collet chucks  
M4 (DIN 352, DIN 371), M6 (DIN 357, DIN 376)

Ø mm	Square mm	Part number	Price in €
4,5	3,4	6 32 06 065 00 5	22,74

**Collets**

for collets and floating collet chucks  
M5 (DIN 352, DIN 371), M6 (DIN 352), M7 (DIN 352),  
M8 (DIN 352, DIN 357, DIN 376)

Ø mm	Square mm	Part number	Price in €
6	4,9	6 32 06 066 00 8	22,74

**Collets**

for collets and floating collet chucks  
M7 (DIN 371), M9 (DIN 352) M 10 (DIN 352, DIN 357,  
DIN 376)

Ø mm	Square mm	Part number	Price in €
7	5,5	6 32 06 070 00 6	22,74

**Collets**

for collets and floating collet chucks  
M8 (DIN 371), M11 (DIN 352)

Ø mm	Square mm	Part number	Price in €
8	6,2	6 32 06 078 00 9	22,74

**Collets**

for collets and floating collet chucks  
M10 (DIN 371)

Ø mm	Square mm	Part number	Price in €
10	8	6 32 06 079 00 3	22,09

**Collets**

for collets and floating collet chucks  
M12 (DIN 357, DIN 371, DIN 376)

Ø mm	Square mm	Part number	Price in €
9	7	6 32 06 075 00 4	22,74

**Jaw chuck**

for tapping drill direct adaptor clamping range 2.8 - 9.0 mm,  
with key wrench

Part number	Price in €
6 32 06 019 00 9	83,40

**Floating jaw chuck**

for tapping drill direct adaptor clamping range 2.8 - 9.0 mm,  
with key wrench

Part number	Price in €
6 32 06 041 00 8	123,11

**Drifts**

for drill chuck up to B12, length 125 mm, pack of 2

Mount	Length mm	Part number	Price in €
B 12	125	6 33 05 009 01 3	27,66

**Depth stop**

Part number	Price in €
3 21 27 005 00 6	5,45

**Suspension Device**

for hooking onto a balancer  
horizontal and vertical

Part number	Price in €
3 21 25 050 00 7	9,70





## Reliable connections: the FEIN screwdriver range.

Extremely reliable and custom-made for the intended application, FEIN power screwdrivers produce top-class results and optimum screw connection quality - even in the toughest conditions. Whether in industrial volume production, metal construction, or interior work and renovation. Other benefits of FEIN power screwdrivers include exemplary ergonomics and very low weight, so you can achieve professional, efficient long-lasting results.



---

<b>Metal screw gun</b>	<b>Page</b>	<b>80</b>
For safe, consistent working with self-drilling and thread-moulding screws in roof and facade construction as well as heating, air conditioning and ventilation.		
<hr/>		
<b>Dry wall screw guns</b>	<b>Page</b>	<b>81</b>
The specialist tools for drywall and interior applications. Lightweight, ergonomic and compact for optimum results.		

**SCS 4.8-25**

One of the lightest self-drilling screwdriver in its class for roof and facade construction.



For cordless variant of tool, see page 16

Input	W	450
Output	W	250
Speed, full load	1/min	0 - 2 000
Speed, no load	1/min	0 - 2 500
Screw Ø	mm	4,8
Rapid change chuck		1/4"
Cable with plug	m	5
Weight according to EPTA	kg	1,3
<b>Part number</b>		<b>7 213 04 00 23 9</b>
<b>EAN</b>		<b>4014586853734</b>
<b>Price in € [PC01]</b>		<b>315,00</b>

**FEIN benefits:**

- ▶ Safe working with self-drilling and thread-moulding screws up to 4.8 mm with or without sealing disc. It is also suitable for wing screws.
- ▶ Lightweight drill/driver for fatigue-free working in roof and facade construction as well as heating, air conditioning and ventilation.
- ▶ Adjustable, power-sensitive FEIN universal clutch for optimum configuration of torque when working without depth stop.
- ▶ FEIN high-power motor.
- ▶ Practical hand strap.

**Price includes:**

- 1 depth stop, 1 magnetic holder for bits 1/4", 1 bit 1/4" for cross-slotted screws size 2 / Phillips (form H) extra hard, 1 hand strap, 1 belt clip

**Metal screw gun**

**General accessories**



**Tool case**

Plastic, inner dimensions: 470 x 275 x 116 mm

Part number	Price in €
3 39 01 118 01 0	37,26



**Plastic box**

Box insert with lockable lid for small parts and accessories, suitable for tool box 3 39 01 118 01 0, max 5 items/box.

Part number	Price in €
3 39 01 119 00 0	3,97



**Tool holder 1/4" external hexagon**

1/4" Drive-Hex Socket with quick-change chuck

Ø mm	L mm	Part number	Price in €
15	51	6 05 10 011 00 9	18,17



**Tool holder 1/4" external hexagon**

1/4" Drive-Hex Socket with spring washer, magnetic

Ø mm	L mm	Part number	Price in €
10,6	45	6 05 10 215 00 3	22,52



Fastening

		SCT 5-40 M	SCT 5-40 X
		Autofeed screwdriver for quick repeated screw fittings with quiet clutch.	The specialist tool for drywall and interior work with quiet clutch.
<b>Page</b>		82	82
<b>Technical features</b>	Input	450 W	450 W
	Speed, no load	0 - 4 000 1/min	0 - 4 000 1/min
	Max. torque (hard/soft)	12 / - Nm	12 / - Nm
	Weight according to EPTA	1,6 kg	1,3 kg
	Screw Ø	5 mm	5 mm
	Rapid change chuck	1/4"	1/4"

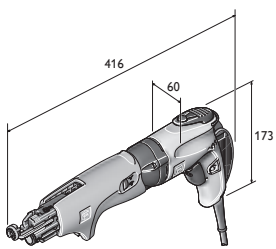

SCT 5-40 M

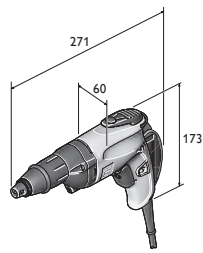

SCT 5-40 X

**SCT 5-40 M**

Autofeed screwdriver for quick repeated screw fittings with quiet clutch.



For accessories, see page 83  
For cordless variant of tool, see page 16

Input	W	450
Output	W	250
Speed, full load	1/min	0 - 2 700
Speed, no load	1/min	0 - 4 000
Max. torque (hard/soft)	Nm	12 / -
Screw Ø	mm	5
Screw length	mm	25 - 55
Rapid change chuck		1/4"
Cable with plug	m	5
Weight according to EPTA	kg	1,6
<b>Part number</b>		<b>7 213 06 50 01 8</b>
<b>EAN</b>		<b>4014586854205</b>
<b>Price in € [PC01]</b>		<b>362,25</b>

**FEIN benefits:**

- ▶ Drywall construction screwdriver SCT 5-40 X incl. magazine M55 X.
- ▶ QuickLIN for tool-free removal collated strips, setting of screw length and driving depth as well as quick cleaning.
- ▶ Speed-optimised; for rapid fixing of plasterboard to wood or metal frames.
- ▶ One of the lightest screwdrivers in its class.
- ▶ Silent FEIN CLIC-STOP clutch.
- ▶ Point placement accuracy with infinitely variable electronic speed setting.
- ▶ Patented screw transport system.
- ▶ Additional depth stop for non-collated screws.
- ▶ Ideally suited for single-hand use.
- ▶ Magazine can be rotated through 360 degrees.
- ▶ Robust shell casing.
- ▶ Market-leading ergonomics with FEIN Sensitive handle.
- ▶ FEIN high-power motor.
- ▶ Vibration-free stop.
- ▶ Practical hand strap.

**Price includes:**

1 Collated cartridge for collated screws, 1 bit 1/4" for cross-slotted screws size 2 / Phillips (form H) with dust-protection ring, 1 depth stop, 1 magnetic holder for bits 1/4", 1 bit 1/4" for cross-slotted screws size 2 / Phillips (form H) with dust-protection ring, 1 hand strap, 1 belt clip, 1 plastic carrying case

**SCT 5-40 X**

The specialist tool for drywall and interior work with quiet clutch.



For accessories, see page 83  
For cordless variant of tool, see page 16

Input	W	450
Output	W	250
Speed, full load	1/min	0 - 2 700
Speed, no load	1/min	0 - 4 000
Max. torque (hard/soft)	Nm	12 / -
Screw Ø	mm	5
Rapid change chuck		1/4"
Cable with plug	m	5
Weight according to EPTA	kg	1,3
<b>Part number</b>		<b>7 213 13 00 23 0</b>
<b>EAN</b>		<b>4014586860923</b>
<b>Price in € [PC01]</b>		<b>249,90</b>

**FEIN benefits:**

- ▶ Speed-optimised; for rapid fixing of plasterboard to wood or metal frames.
- ▶ Silent FEIN CLIC-STOP clutch for working in offices, hospitals etc. without causing a disturbance.
- ▶ The depth stop supplied means that drywall is not damaged and you need simply grout after screwdriving.
- ▶ One of the lightest screwdrivers in its class.
- ▶ Market-leading ergonomics with FEIN Sensitive handle.
- ▶ Point placement accuracy with infinitely variable electronic speed setting.
- ▶ FEIN high-power motor.
- ▶ Vibration-free stop.
- ▶ Rapid changeover to collated strips.
- ▶ Easily adjustable and replaceable depth stop.
- ▶ Dustproof stop sleeve.
- ▶ Extremely lightweight.
- ▶ Practical hand strap.

**Price includes:**

1 hand strap, 1 belt clip, 1 depth stop, dust-proof protection, 1 magnetic holder for bits 1/4", 1 bit 1/4" for cross-slotted screws size 2 / Phillips (form H) with dust-protection ring



**General accessories**



**Tool case**  
Plastic, inner dimensions: 470 x 275 x 116 mm

Part number	Price in €
3 39 01 118 01 0	37,26



**Plastic box**  
Box insert with lockable lid for small parts and accessories, suitable for tool box 3 39 01 118 01 0, max 5 items/box.

Part number	Price in €
3 39 01 119 00 0	3,97



**Tool holder 1/4" external hexagon**  
1/4" Drive-Hex Socket with quick-change chuck

Ø mm	L mm	Part number	Price in €
15	51	6 05 10 011 00 9	18,17



**Bits 1/4" Hex socket**  
Form H/Phillips (pack of 5) extra hard, with dust protection ring

L mm	Size	Part number	Price in €
25	2	6 27 12 109 03 4	7,96

**Accessories for autofeed screwdrivers**



**M55 X magazine**  
for collated screws of 25 to 55 mm length and max. Ø 5 mm, tool-free changeover, weight 0.4 kg.

Part number	Price in €
9 01 04 009 01 0	198,45



**M55 X magazine extension with belt guide**  
Length 520 mm

Part number	Price in €
9 01 04 010 01 0	199,21



**Bits 1/4" Hex socket**  
for screwdriving into ceilings and floors  
Form H/Phillips, size 2

Part number	Price in €
6 05 03 306 00 8	7,43



**High-speed construction screws**  
Fine-pitch screw for fastening drywall to metal substructures, countersunk head, Ø 8 mm

Ø mm	L mm	No. in pack pcs	Part number	Price in €
3,9	35	1 000	6 39 01 030 01 4	44,94
3,9	35	10 000	6 39 01 030 02 0	265,65



**High-speed construction screws**  
Coarse-pitch screw for fastening drywall to wood substructures, countersunk head, Ø 8 mm

Ø mm	L mm	No. in pack pcs	Part number	Price in €
3,9	30	1 000	6 39 01 031 01 3	44,94
3,9	30	10 000	6 39 01 031 02 0	265,65
3,9	35	1 000	6 39 01 032 01 6	44,94
3,9	35	10 000	6 39 01 032 02 0	265,65
3,9	45	1 000	6 39 01 033 01 0	58,49
3,9	45	10 000	6 39 01 033 02 0	345,78



**High-speed construction screws**  
Double threaded with milled rib for fastening Fermacell panels to metal or wood substructures.

Ø mm	L mm	No. in pack pcs	Part number	Price in €
3,9	30	1 000	6 39 01 034 01 8	48,68
3,9	30	10 000	6 39 01 034 02 0	345,78



**High-speed construction screws**  
Double threaded with milled rib for wood substructures.

Ø mm	L mm	No. in pack pcs	Part number	Price in €
4,2	35	1 000	6 39 01 035 01 2	56,72
4,2	35	10 000	6 39 01 035 02 0	335,30







# More than 100 years of working in continuous use: the FEIN grinding specialists.

Experience is everything, especially when like FEIN you are building resilient, user- focused, ergonomic and innovative grinding power tools for industry and manual trades. They come in various performance classes ranging from 350 to 3 700 watts and for tough continuous use for example in foundries, steel or shipbuilding. From handy compact angle grinders to extremely powerful and large angle grinders and offering a wide range of straight grinders with a wide high frequency range, FEIN works hard to satisfy every need in the sanding department too.



---

## Compact angle grinders Page 86

Three equipment lines, the same unbeatable quality - the right angle grinder for every job.

---

## Angle Grinders Page 95

Superior performance, comfortable and optimum safety FEIN angle grinders for heavy-duty grinding and cutting work.

---

## Die Grinders Page 100

The specialist tools for use in metal working, for grinding , brushing, deburring and polishing.

---

## High Frequency Angle Grinders Page 106

The specialists in continuous use when cutting and roughing-down under tough environmental conditions.

---

## High Frequency Straight Grinders Page 111

The specialists in continuous use when cutting and roughing-down under tough environmental conditions.

---

## Frequency converter Page 115



	MSfv 649-1	WSG 7-115	WSG 8-115	WSG 8-125	WSG 12-125 P	WSG 11-125	WSG 15-125 P	WSG 11-125 RT	WSG 15-125 PR
	Long-necked angle grinder with spindle M 14 for working in difficult-to-reach areas.	Ergonomic 700 W compact angle grinder for light-duty sanding and cutting.	Ergonomic 800 W compact angle grinder for deburring, sanding and cutting.		Ergonomic 1 200 W compact angle grinder with high power reserve for effective sanding and cutting.	Ergonomic 1 100 W compact angle grinder for deburring, sanding and cutting.	Ergonomic 1 500 W compact angle grinder with high power reserve for effective sanding and cutting.	Ergonomic 1 100 W compact angle grinder with FEIN ErgoGrip for fatigue-free working.	Ergonomic 1 500 W compact angle grinder with FEIN ErgoGrip for fatigue-free working.
Page	88	88	88	88	89	89	89	90	90
Application	roughing-down	▲▲	▲	▲	▲	▲▲	▲▲	▲▲	▲▲
	Deburring	▲	▲	▲▲	▲▲	▲	▲	▲	▲
	dividing		▲	▲	▲	▲▲	▲▲	▲▲	▲▲
	brushing			▲	▲	▲▲	▲▲	▲▲	▲▲
	satin-finishing								
	polishing								
Equipment	POWERtronic tacho electronics					●		●	●
	Soft start					●		●	●
	Restart protection		●	●	●	●	●	●	●
	Blockage monitoring					●	●	●	●
	Electronic overload protection					●		●	●
	Electronic speed preselection								
	Long neck	●							
	AutoStop dead man's switch	●						●	
Technical features	Input	750 W	760 W	800 W	800 W	1 200 W	1 200 W	1 500 W	1 500 W
	Speed, no load	12 000 1/min	12 500 1/min	11 000 1/min	11 000 1/min	11 000 1/min	11 000 1/min	11 000 1/min	11 000 1/min
	Weight according to EPTA	4 kg	1,7 kg	2 kg	2 kg	2,1 kg	2,1 kg	2,3 kg	2,4 kg
	Flange	M 14	M 14	M 14	M 14	M 14	M 14	M 14	M 14
	Grinding disc Ø	125 mm	115 mm	115 mm	125 mm	125 mm	125 mm	125 mm	125 mm
	Elast. Backing pad Ø		115 mm	115 mm	125 mm	125 mm	125 mm	125 mm	125 mm

▲ suitability    ▲▲ optimal suitability    ● included

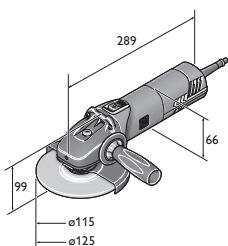

WSG 12-125 P  
WSG 12-125 PQ  
WSG 8-115  
WSG 8-125

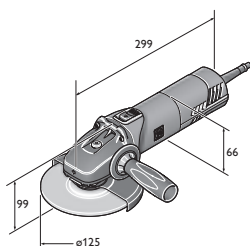

WSG 11-125  
WSG 15-125 P  
WSG 15-125 PQ  
WSG 17-125 P  
WSG 17-125 PQ

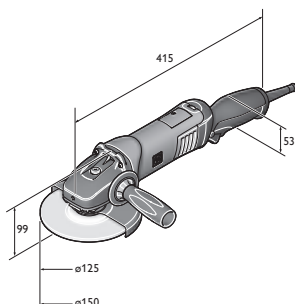

WSG 17-150 PR  
WSG 17-150 PRT  
WSG 17-70 Inox R  
WSG 17-70 Inox RT

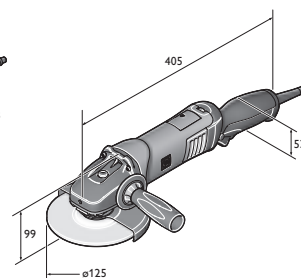

WSG 11-125 RT  
WSG 15-125 PR  
WSG 15-125 PRT  
WSG 17-125 PR  
WSG 17-125 PRT



	WSG 15-125 PRT	WSG 17-125 P	WSG 17-125 PS	WSG 17-150 P	WSG 17-150 Inox	WSG 17-125 PR	WSG 17-125 PRT	WSG 17-150 PR	WSG 17-150 PRT	WSG 17-70 Inox R	WSG 17-70 Inox RT
		Ergonomic compact angle grinder with high power reserve for effective sanding and cutting.	The specialist tool for serrated and fibre discs with extra high torque.	Ergonomic compact angle grinder with high power reserve for effective sanding and cutting.	The specialist tool with variable speed for stainless steel processing.	Ergonomic compact angle grinder with FEIN ErgoGrip for fatigue-free working.				Ergonomic compact angle grinder with FEIN ErgoGrip for fatigue-free working in stainless steel applications.	
	90	91	91	92	92	92	93	93	93	93	94
	▲▲	▲▲	▲▲	▲▲	▲▲	▲▲	▲▲	▲▲	▲▲	▲▲	▲▲
	▲	▲	▲	▲	▲	▲	▲	▲	▲	▲	▲
	▲▲	▲▲	▲	▲▲	▲	▲▲	▲▲	▲▲	▲▲	▲	▲
	▲▲	▲▲	▲	▲▲	▲	▲▲	▲▲	▲▲	▲▲	▲	▲
					▲▲					▲▲	▲▲
					▲					▲	▲
	●	●	●	●	●	●	●	●	●	●	●
	●	●	●	●	●	●	●	●	●	●	●
	●	●	●	●	●	●	●	●	●	●	●
	●	●	●	●	●	●	●	●	●	●	●
	●	●	●	●	●	●	●	●	●	●	●
	●				●				●		●
	1 500 W	1 700 W	1 700 W	1 700 W	1 700 W	1 700 W	1 700 W	1 700 W	1 700 W	1 700 W	1 700 W
	11 000 1/min	11 000 1/min	8 500 1/min	8 500 1/min	2 700 - 8 500 1/min	11 000 1/min	11 000 1/min	8 500 1/min	8 500 1/min	2 700 - 8 500 1/min	2 700 - 8 500 1/min
	2,4 kg	2,3 kg	2,4 kg	2,4 kg	2,4 kg	2,4 kg	2,4 kg	2,6 kg	2,6 kg	2,5 kg	2,5 kg
	M 14	M 14	M 14	M 14	M 14	M 14	M 14	M 14	M 14	M 14	M 14
	125 mm	125 mm	125 mm	150 mm	125 mm	125 mm	150 mm	150 mm	150 mm	125 mm	125 mm
	125 mm	125 mm	125 mm	150 mm	125 mm	125 mm	150 mm	150 mm	150 mm	125 mm	125 mm

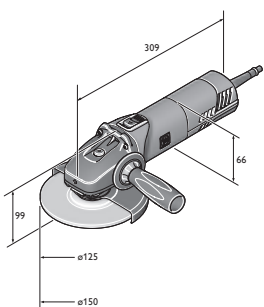

WSG 17-125 PS  
WSG 17-125 PSQ  
WSG 17-150 P  
WSG 17-150 PQ  
WSG 17-70 Inox

**MSfv 649-1**

Long-necked angle grinder with spindle M 14 for working in difficult-to-reach areas.



For accessories, see page 94

Input	W	750
Output	W	480
Speed, no load	1/min	12 000
Grinding disc Ø	mm	125
Flange		M 14
Cable with plug	m	5
Weight according to EPTA	kg	4
<b>Part number</b>		<b>7 221 31 00 23 0</b>
<b>EAN</b>		<b>4014586858371</b>
<b>Price in € [PC01]</b>		<b>676,20</b>

**FEIN benefits:**

- ▶ Very flat drive head to plunge a long way into workpieces.
- ▶ Safe and comfortable handling thanks to convenient handle positions.
- ▶ Wheel guard with protection against twisting.
- ▶ AutoStop dead man's switch

**Price includes:**

1 wheel guard, 1 pair of flanges, 1 set of keys

**WSG 7-115**

Ergonomic 700 W compact angle grinder for light-duty sanding and cutting.



For accessories, see page 94

Input	W	760
Output	W	420
Speed, no load	1/min	12 500
Grinding disc Ø	mm	115
Elast. Backing pad Ø	mm	115
Flange		M 14
Cable with plug	m	2,5
Weight according to EPTA	kg	1,7
<b>Part number</b>		<b>7 221 98 60 00 0</b>
<b>EAN</b>		<b>4014586885506</b>
<b>Price in € [PC19]</b>		<b>82,95</b>

**FEIN benefits:**

- ▶ Perfect ergonomics thanks to lateral slide switch and small grip dimension.
- ▶ Fatigue-free working thanks to low weight.
- ▶ Solid metal gearbox head can be turned in 90° steps for maximum robustness and service life and very good access to difficult-to-reach spots.
- ▶ Enhanced safety through integrated restart protection.

**Price includes:**

1 wheel guard, 1 pair of flanges, 1 additional handle, 1 key

**WSG 8-115**

Ergonomic 800 W compact angle grinder for deburring, sanding and cutting.



For accessories, see page 94

Input	W	800
Output	W	520
Speed, no load	1/min	11 000
Grinding disc Ø	mm	115
Elast. Backing pad Ø	mm	115
Flange		M 14
Cable with plug	m	4
Weight according to EPTA	kg	2
<b>Part number</b>		<b>7 221 73 60 00 0</b>
<b>EAN</b>		<b>4014586875033</b>
<b>Price in € [PC19]</b>		<b>114,45</b>

**FEIN benefits:**

- ▶ Longer carbon brush life and tool removes more material than comparable angle grinders.
- ▶ Solid metal gearbox head for maximum robustness and service life.
- ▶ The lightest model of its kind.
- ▶ H 07 industrial cable.
- ▶ The best vibration performance in its class.
- ▶ Safety hood can be adjusted without tools and has anti-twist protection.
- ▶ Spindle lock.
- ▶ Enhanced safety through integrated restart protection.

**Price includes:**

1 wheel guard, 1 pair of flanges, 1 additional handle, 1 key

**WSG 8-125**

Ergonomic 800 W compact angle grinder for deburring, sanding and cutting.



For accessories, see page 94

Input	W	800
Output	W	520
Speed, no load	1/min	11 000
Grinding disc Ø	mm	125
Elast. Backing pad Ø	mm	125
Flange		M 14
Cable with plug	m	4
Weight according to EPTA	kg	2
<b>Part number</b>		<b>7 221 74 60 00 0</b>
<b>EAN</b>		<b>4014586875125</b>
<b>Price in € [PC19]</b>		<b>116,55</b>

**FEIN benefits:**

- ▶ Longer carbon brush life and tool removes more material than comparable angle grinders.
- ▶ Solid metal gearbox head for maximum robustness and service life.
- ▶ The lightest model of its kind.
- ▶ Enhanced safety through integrated restart protection.
- ▶ H 07 industrial cable.
- ▶ The best vibration performance in its class.
- ▶ Safety hood can be adjusted without tools and has anti-twist protection.
- ▶ Spindle lock.

**Price includes:**

1 wheel guard, 1 pair of flanges, 1 additional handle, 1 key



**WSG 12-125 P**

Ergonomic 1 200 W compact angle grinder with high power reserve for effective sanding and cutting.



For accessories, see page 94

Input	W	1 200
Output	W	650
Speed, no load	1/min	11 000
Grinding disc Ø	mm	125
Elast. Backing pad Ø	mm	125
Flange		M 14
Cable with plug	m	4
Weight according to EPTA	kg	2,1
<b>Part number</b>		<b>7 221 75 60 00 0</b>
<b>EAN</b>		<b>4014586875217</b>
<b>Price in € [PC19]</b>		<b>162,75</b>

**FEIN benefits:**

- ▶ Longer carbon brush life and tool removes more material than comparable angle grinders.
- ▶ POWERtronic for enormous power, power reserve and exceptional speed stability under load.
- ▶ User protection features include kickback stop, restart protection, soft start and electronic overload protection.
- ▶ The lightest and shortest model of its kind.
- ▶ Solid metal gearbox head for maximum robustness and service life.
- ▶ The best vibration performance in its class.
- ▶ H 07 industrial cable.

**Price includes:**

- 1 wheel guard, 1 pair of flanges, 1 anti-vibration handle, 1 key

**WSG 12-125 PQ**

Ergonomic 1 200 W compact angle grinder with high power reserve for effective sanding and cutting.



For accessories, see page 94

Input	W	1 200
Output	W	650
Speed, no load	1/min	11 000
Grinding disc Ø	mm	125
Elast. Backing pad Ø	mm	125
Flange		M 14
Cable with plug	m	4
Weight according to EPTA	kg	2,1
<b>Part number</b>		<b>7 221 76 60 00 0</b>
<b>EAN</b>		<b>4014586875309</b>
<b>Price in € [PC19]</b>		<b>173,25</b>

**FEIN benefits:**

- ▶ Longer carbon brush life and tool removes more material than comparable angle grinders.
- ▶ POWERtronic for enormous power, power reserve and exceptional speed stability under load.
- ▶ User protection features include kickback stop, restart protection, soft start and electronic overload protection.
- ▶ The lightest and shortest model of its kind.
- ▶ Solid metal gearbox head for maximum robustness and service life.
- ▶ The best vibration performance in its class.
- ▶ H 07 industrial cable.

**Price includes:**

- 1 wheel guard, 1 Tool-free quick-clamping nut, 1 anti-vibration handle, 1 key

**WSG 11-125**

Ergonomic 1 100 W compact angle grinder for deburring, sanding and cutting.



For accessories, see page 94

Input	W	1 200
Output	W	650
Speed, no load	1/min	11 000
Grinding disc Ø	mm	125
Elast. Backing pad Ø	mm	125
Flange		M 14
Cable with plug	m	4
Weight according to EPTA	kg	2,1
<b>Part number</b>		<b>7 221 77 60 00 0</b>
<b>EAN</b>		<b>4014586875316</b>
<b>Price in € [PC19]</b>		<b>130,20</b>

**FEIN benefits:**

- ▶ Longer carbon brush life and tool removes more material than comparable angle grinders.
- ▶ Solid metal gearbox head for maximum robustness and service life.
- ▶ The lightest model of its kind.
- ▶ H 07 industrial cable.
- ▶ The best vibration performance in its class.
- ▶ Safety hood can be adjusted without tools and has anti-twist protection.
- ▶ Spindle lock.
- ▶ Enhanced safety through integrated restart protection.

**Price includes:**

- 1 wheel guard, 1 pair of flanges, 1 additional handle, 1 key

**WSG 15-125 P**

Ergonomic 1 500 W compact angle grinder with high power reserve for effective sanding and cutting.



For accessories, see page 94

Input	W	1 500
Output	W	900
Speed, no load	1/min	11 000
Grinding disc Ø	mm	125
Elast. Backing pad Ø	mm	125
Flange		M 14
Cable with plug	m	4
Weight according to EPTA	kg	2,3
<b>Part number</b>		<b>7 221 78 60 00 0</b>
<b>EAN</b>		<b>4014586875323</b>
<b>Price in € [PC19]</b>		<b>183,75</b>

**FEIN benefits:**

- ▶ Longer carbon brush life and tool removes more material than comparable angle grinders.
- ▶ POWERtronic for enormous power, power reserve and exceptional speed stability under load.
- ▶ User protection features include kickback stop, restart protection, soft start and electronic overload protection.
- ▶ The lightest and shortest model of its kind.
- ▶ Solid metal gearbox head for maximum robustness and service life.
- ▶ The best vibration performance in its class.
- ▶ H 07 industrial cable.

**Price includes:**

- 1 wheel guard, 1 pair of flanges, 1 anti-vibration handle, 1 key

Grinding

**WSG 15-125 PQ**

Ergonomic 1 500 W compact angle grinder with high power reserve for effective sanding and cutting.



For accessories, see page 94

Input	W	1 500
Output	W	900
Speed, no load	1/min	11 000
Grinding disc Ø	mm	125
Elast. Backing pad Ø	mm	125
Flange		M 14
Cable with plug	m	4
Weight according to EPTA	kg	2,3
<b>Part number</b>		<b>7 221 79 60 00 0</b>
<b>EAN</b>		<b>4014586875330</b>
<b>Price in € [PC19]</b>		<b>196,35</b>

**FEIN benefits:**

- ▶ Longer carbon brush life and tool removes more material than comparable angle grinders.
- ▶ POWERtronic for enormous power, power reserve and exceptional speed stability under load.
- ▶ User protection features include kickback stop, restart protection, soft start and electronic overload protection.
- ▶ The lightest and shortest model of its kind.
- ▶ Solid metal gearbox head for maximum robustness and service life.
- ▶ The best vibration performance in its class.
- ▶ H 07 industrial cable.

**Price includes:**

- 1 wheel guard, 1 Tool-free quick-clamping nut, 1 anti-vibration handle, 1 key

**WSG 11-125 RT**

Ergonomic 1 100 W compact angle grinder with FEIN ErgoGrip for fatigue-free working.



For accessories, see page 94

Input	W	1 100
Output	W	700
Speed, no load	1/min	11 000
Grinding disc Ø	mm	125
Elast. Backing pad Ø	mm	125
Flange		M 14
Cable with plug	m	4
Weight according to EPTA	kg	2,4
<b>Part number</b>		<b>7 221 87 60 00 0</b>
<b>EAN</b>		<b>4014586879888</b>
<b>Price in € [PC19]</b>		<b>162,75</b>

**FEIN benefits:**

- ▶ FEIN ErgoGrip - Unique ergonomic concept for fatigue-free working (patent pending).
- ▶ Longer carbon brush life and tool removes more material than comparable angle grinders.
- ▶ Solid metal gearbox head for maximum robustness and service life.
- ▶ AutoStop dead man's switch
- ▶ The lightest model of its kind.
- ▶ Industrial cable H07, length 4m - unique in this class.
- ▶ The best vibration performance in its class.
- ▶ Safety hood can be adjusted without tools and has anti-twist protection.

**Price includes:**

- 1 wheel guard, 1 pair of flanges, 1 additional handle, 1 key

**WSG 15-125 PR**

Ergonomic 1 500 W compact angle grinder with FEIN ErgoGrip for fatigue-free working.



For accessories, see page 94

Input	W	1 500
Output	W	900
Speed, no load	1/min	11 000
Grinding disc Ø	mm	125
Elast. Backing pad Ø	mm	125
Flange		M 14
Cable with plug	m	4
Weight according to EPTA	kg	2,4
<b>Part number</b>		<b>7 221 90 60 00 0</b>
<b>EAN</b>		<b>4014586879970</b>
<b>Price in € [PC19]</b>		<b>217,35</b>

**FEIN benefits:**

- ▶ FEIN ErgoGrip - Unique ergonomic concept for fatigue-free working (patent pending).
- ▶ POWERtronic for enormous power, power reserve and exceptional speed stability under load.
- ▶ User protection features include kickback stop, restart protection, soft start and electronic overload protection.
- ▶ The lightest model of its kind.
- ▶ Solid metal gearbox head.
- ▶ The best vibration performance in its class.
- ▶ Industrial cable H07, length 4m.

**Price includes:**

- 1 wheel guard, 1 pair of flanges, 1 anti-vibration handle, 1 key

**WSG 15-125 PRT**

Ergonomic 1 500 W compact angle grinder with FEIN ErgoGrip for fatigue-free working.



For accessories, see page 94

Input	W	1 500
Output	W	900
Speed, no load	1/min	11 000
Grinding disc Ø	mm	125
Elast. Backing pad Ø	mm	125
Flange		M 14
Cable with plug	m	4
Weight according to EPTA	kg	2,4
<b>Part number</b>		<b>7 221 91 60 00 0</b>
<b>EAN</b>		<b>4014586880020</b>
<b>Price in € [PC19]</b>		<b>217,35</b>

**FEIN benefits:**

- ▶ FEIN ErgoGrip - Unique ergonomic concept for fatigue-free working (patent pending).
- ▶ POWERtronic for enormous power, power reserve and exceptional speed stability under load.
- ▶ User protection features include kickback stop, restart protection, soft start and electronic overload protection.
- ▶ AutoStop dead man's switch
- ▶ The lightest model of its kind.
- ▶ Solid metal gearbox head.
- ▶ The best vibration performance in its class.
- ▶ Industrial cable H07, length 4m.

**Price includes:**

- 1 wheel guard, 1 pair of flanges, 1 anti-vibration handle, 1 key



**WSG 17-125 P**

Ergonomic compact angle grinder with high power reserve for effective sanding and cutting.



For accessories, see page 94

Input	W	1 700
Output	W	1 000
Speed, no load	1/min	11 000
Grinding disc Ø	mm	125
Elast. Backing pad Ø	mm	125
Flange		M 14
Cable with plug	m	4
Weight according to EPTA	kg	2,3
<b>Part number</b>		<b>7 222 07 60 00 0</b>
<b>EAN</b>		<b>4014586883120</b>
<b>Price in € [PC19]</b>		<b>194,25</b>

**FEIN benefits:**

- ▶ User protection features include kickback stop, restart protection, soft start and electronic overload protection.
- ▶ POWERtronic for enormous power, power reserve and exceptional speed stability under load.
- ▶ Longer carbon brush life and tool removes more material than comparable angle grinders.
- ▶ Industrial cable H07, length 4m.
- ▶ Solid metal gearbox head for maximum robustness and service life.
- ▶ The best vibration performance in its class.
- ▶ The lightest and shortest model of its kind.

**Price includes:**

1 wheel guard, 1 pair of flanges, 1 anti-vibration handle, 1 key

**WSG 17-125 PQ**

Ergonomic compact angle grinder with high power reserve for effective sanding and cutting.



For accessories, see page 94

Input	W	1 700
Output	W	1 000
Speed, no load	1/min	11 000
Grinding disc Ø	mm	125
Elast. Backing pad Ø	mm	125
Flange		M 14
Cable with plug	m	4
Weight according to EPTA	kg	2,3
<b>Part number</b>		<b>7 222 08 60 00 0</b>
<b>EAN</b>		<b>4014586883175</b>
<b>Price in € [PC19]</b>		<b>204,75</b>

**FEIN benefits:**

- ▶ Longer carbon brush life and tool removes more material than comparable angle grinders.
- ▶ POWERtronic for enormous power, power reserve and exceptional speed stability under load.
- ▶ User protection features include kickback stop, restart protection, soft start and electronic overload protection.
- ▶ The lightest and shortest model of its kind.
- ▶ Solid metal gearbox head for maximum robustness and service life.
- ▶ The best vibration performance in its class.
- ▶ Industrial cable H07, length 4m.

**Price includes:**

1 wheel guard, 1 Inner flange, 1 Tool-free quick-clamping nut, 1 anti-vibration handle, 1 key

**WSG 17-125 PS**

The specialist tool for serrated and fibre discs with extra high torque.



For accessories, see page 94

Input	W	1 700
Output	W	1 000
Speed, no load	1/min	8 500
Grinding disc Ø	mm	125
Elast. Backing pad Ø	mm	125
Flange		M 14
Cable with plug	m	4
Weight according to EPTA	kg	2,4
<b>Part number</b>		<b>7 222 09 60 00 0</b>
<b>EAN</b>		<b>4014586883236</b>
<b>Price in € [PC19]</b>		<b>194,25</b>

**FEIN benefits:**

- ▶ Longer carbon brush life and tool removes more material than comparable angle grinders.
- ▶ Optimum speed and high torque, specially for serrated and fibre discs.
- ▶ POWERtronic for enormous power, power reserve and exceptional speed stability under load.
- ▶ The lightest and shortest model of its kind.
- ▶ Blockage monitoring.
- ▶ Restart protection.
- ▶ Soft start.
- ▶ Electronic overload protection.
- ▶ Solid metal gearbox head for maximum robustness and service life.
- ▶ The best vibration performance in its class.
- ▶ Industrial cable H07, length 4m.

**Price includes:**

1 wheel guard, 1 pair of flanges, 1 anti-vibration handle, 1 key

**WSG 17-125 PSQ**

The specialist tool for serrated and fibre discs with extra high torque.



For accessories, see page 94

Input	W	1 700
Output	W	1 000
Speed, no load	1/min	8 500
Grinding disc Ø	mm	125
Elast. Backing pad Ø	mm	125
Flange		M 14
Cable with plug	m	4
Weight according to EPTA	kg	2,4
<b>Part number</b>		<b>7 222 10 60 00 0</b>
<b>EAN</b>		<b>4014586883304</b>
<b>Price in € [PC19]</b>		<b>204,75</b>

**FEIN benefits:**

- ▶ Longer carbon brush life and tool removes more material than comparable angle grinders.
- ▶ Optimum speed and high torque, specially for serrated and fibre discs.
- ▶ POWERtronic for enormous power, power reserve and exceptional speed stability under load.
- ▶ The lightest and shortest model of its kind.
- ▶ Blockage monitoring.
- ▶ Restart protection.
- ▶ Soft start.
- ▶ Electronic overload protection.
- ▶ Solid metal gearbox head for maximum robustness and service life.
- ▶ The best vibration performance in its class.
- ▶ Industrial cable H07, length 4m.

**Price includes:**

1 wheel guard, 1 key, 1 Inner flange, 1 Tool-free quick-clamping nut, 1 anti-vibration handle

Grinding



**WSG 17-150 P**

Ergonomic compact angle grinder with high power reserve for effective sanding and cutting.



For accessories, see page 94

Input	W	1 700
Output	W	1 000
Speed, no load	1/min	8 500
Grinding disc Ø	mm	150
Elast. Backing pad Ø	mm	150
Flange		M 14
Cable with plug	m	4
Weight according to EPTA	kg	2,4
<b>Part number</b>		<b>7 222 11 60 00 0</b>
<b>EAN</b>		<b>4014586883366</b>
<b>Price in € [PC19]</b>		<b>194,25</b>

**FEIN benefits:**

- ▶ Longer carbon brush life and tool removes more material than comparable angle grinders.
- ▶ POWERtronic for enormous power, power reserve and exceptional speed stability under load.
- ▶ User protection features include kickback stop, restart protection, soft start and electronic overload protection.
- ▶ The lightest and shortest model of its kind.
- ▶ Solid metal gearbox head for maximum robustness and service life.
- ▶ The best vibration performance in its class.
- ▶ Industrial cable H07, length 4m.

**Price includes:**

- 1 wheel guard, 1 pair of flanges, 1 anti-vibration handle, 1 key

**WSG 17-150 PQ**

Ergonomic compact angle grinder with high power reserve for effective sanding and cutting.



For accessories, see page 94

Input	W	1 700
Output	W	1 000
Speed, no load	1/min	8 500
Grinding disc Ø	mm	150
Elast. Backing pad Ø	mm	150
Flange		M 14
Cable with plug	m	4
Weight according to EPTA	kg	2,4
<b>Part number</b>		<b>7 222 12 60 00 0</b>
<b>EAN</b>		<b>4014586883434</b>
<b>Price in € [PC19]</b>		<b>204,75</b>

**FEIN benefits:**

- ▶ Longer carbon brush life and tool removes more material than comparable angle grinders.
- ▶ POWERtronic for enormous power, power reserve and exceptional speed stability under load.
- ▶ User protection features include kickback stop, restart protection, soft start and electronic overload protection.
- ▶ The lightest and shortest model of its kind.
- ▶ Solid metal gearbox head for maximum robustness and service life.
- ▶ The best vibration performance in its class.
- ▶ Industrial cable H07, length 4m.

**Price includes:**

- 1 wheel guard, 1 Inner flange, 1 Tool-free quick-clamping nut, 1 anti-vibration handle, 1 key

**WSG 17-70 Inox**

The specialist tool with variable speed for stainless steel processing.



For accessories, see page 94

Input	W	1 700
Output	W	1 000
Speed, no load	1/min	2 700 - 8 500
Grinding disc Ø	mm	125
Elast. Backing pad Ø	mm	125
Flange		M 14
Cable with plug	m	4
Weight according to EPTA	kg	2,4
<b>Part number</b>		<b>7 222 13 60 00 0</b>
<b>EAN</b>		<b>4014586883496</b>
<b>Price in € [PC19]</b>		<b>271,95</b>

**FEIN benefits:**

- ▶ Longer carbon brush life and tool removes more material than comparable angle grinders.
- ▶ Variable speed allows various tools to be used for applications ranging from satin-finishing to sanding stainless steel.
- ▶ POWERtronic for enormous power, power reserve and exceptional speed stability under load.
- ▶ The lightest and shortest model of its kind.
- ▶ Blockage monitoring.
- ▶ Restart protection.
- ▶ Soft start.
- ▶ Electronic overload protection.
- ▶ Solid metal gearbox head for maximum robustness and service life.
- ▶ The best vibration performance in its class.
- ▶ Industrial cable H07, length 4m.

**Price includes:**

- 1 wheel guard, 1 pair of flanges, 1 anti-vibration handle, 1 key

**WSG 17-125 PR**

Ergonomic compact angle grinder with FEIN ErgoGrip for fatigue-free working.



For accessories, see page 94

Input	W	1 700
Output	W	1 000
Speed, no load	1/min	11 000
Grinding disc Ø	mm	125
Elast. Backing pad Ø	mm	125
Flange		M 14
Cable with plug	m	4
Weight according to EPTA	kg	2,4
<b>Part number</b>		<b>7 222 18 60 00 0</b>
<b>EAN</b>		<b>4014586883571</b>
<b>Price in € [PC19]</b>		<b>225,75</b>

**FEIN benefits:**

- ▶ FEIN ErgoGrip - Unique ergonomic concept for fatigue-free working (patent pending).
- ▶ POWERtronic for enormous power, power reserve and exceptional speed stability under load.
- ▶ User protection features include kickback stop, restart protection, soft start and electronic overload protection.
- ▶ The lightest model of its kind.
- ▶ Solid metal gearbox head.
- ▶ The best vibration performance in its class.
- ▶ Industrial cable H07, length 4m.

**Price includes:**

- 1 wheel guard, 1 pair of flanges, 1 anti-vibration handle, 1 key



**WSG 17-125 PRT**

Ergonomic compact angle grinder with FEIN ErgoGrip for fatigue-free working.



For accessories, see page 94

Input	W	1 700
Output	W	1 000
Speed, no load	1/min	11 000
Grinding disc Ø	mm	150
Elast. Backing pad Ø	mm	150
Flange		M 14
Cable with plug	m	4
Weight according to EPTA	kg	2,4
<b>Part number</b>		<b>7 222 19 60 00 0</b>
<b>EAN</b>		<b>4014586883618</b>
<b>Price in € [PC19]</b>		<b>225,75</b>

**FEIN benefits:**

- ▶ FEIN ErgoGrip - Unique ergonomic concept for fatigue-free working (patent pending).
- ▶ POWERtronic for enormous power, power reserve and exceptional speed stability under load.
- ▶ User protection features include kickback stop, restart protection, soft start and electronic overload protection.
- ▶ The lightest model of its kind.
- ▶ Solid metal gearbox head.
- ▶ AutoStop dead man's switch
- ▶ The best vibration performance in its class.
- ▶ Industrial cable H07, length 4m.

**Price includes:**

1 wheel guard, 1 pair of flanges, 1 anti-vibration handle, 1 key

**WSG 17-150 PR**

Ergonomic compact angle grinder with FEIN ErgoGrip for fatigue-free working.



For accessories, see page 94

Input	W	1 700
Output	W	1 000
Speed, no load	1/min	8 500
Grinding disc Ø	mm	150
Elast. Backing pad Ø	mm	150
Flange		M 14
Cable with plug	m	4
Weight according to EPTA	kg	2,6
<b>Part number</b>		<b>7 222 20 60 00 0</b>
<b>EAN</b>		<b>4014586883656</b>
<b>Price in € [PC19]</b>		<b>225,75</b>

**FEIN benefits:**

- ▶ FEIN ErgoGrip - Unique ergonomic concept for fatigue-free working (patent pending).
- ▶ POWERtronic for enormous power, power reserve and exceptional speed stability under load.
- ▶ User protection features include kickback stop, restart protection, soft start and electronic overload protection.
- ▶ The lightest model of its kind.
- ▶ Solid metal gearbox head.
- ▶ The best vibration performance in its class.
- ▶ Industrial cable H07, length 4m.

**Price includes:**

1 wheel guard, 1 pair of flanges, 1 anti-vibration handle, 1 key

**WSG 17-150 PRT**

Ergonomic compact angle grinder with FEIN ErgoGrip for fatigue-free working.



For accessories, see page 94

Input	W	1 700
Output	W	1 000
Speed, no load	1/min	8 500
Grinding disc Ø	mm	150
Elast. Backing pad Ø	mm	150
Flange		M 14
Cable with plug	m	4
Weight according to EPTA	kg	2,6
<b>Part number</b>		<b>7 222 21 60 00 0</b>
<b>EAN</b>		<b>4014586883694</b>
<b>Price in € [PC19]</b>		<b>225,75</b>

**FEIN benefits:**

- ▶ FEIN ErgoGrip - Unique ergonomic concept for fatigue-free working (patent pending).
- ▶ POWERtronic for enormous power, power reserve and exceptional speed stability under load.
- ▶ User protection features include kickback stop, restart protection, soft start and electronic overload protection.
- ▶ AutoStop dead man's switch
- ▶ The lightest model of its kind.
- ▶ Solid metal gearbox head.
- ▶ The best vibration performance in its class.
- ▶ Industrial cable H07, length 4m.

**Price includes:**

1 wheel guard, 1 pair of flanges, 1 anti-vibration handle, 1 key

**WSG 17-70 Inox R**

Ergonomic compact angle grinder with FEIN ErgoGrip for fatigue-free working in stainless steel applications.



For accessories, see page 94

Input	W	1 700
Output	W	1 000
Speed, no load	1/min	2 700 - 8 500
Grinding disc Ø	mm	125
Elast. Backing pad Ø	mm	125
Flange		M 14
Cable with plug	m	4
Weight according to EPTA	kg	2,5
<b>Part number</b>		<b>7 222 22 60 00 0</b>
<b>EAN</b>		<b>4014586883731</b>
<b>Price in € [PC19]</b>		<b>303,45</b>

**FEIN benefits:**

- ▶ FEIN ErgoGrip - Unique ergonomic concept for fatigue-free working (patent pending).
- ▶ POWERtronic for enormous power, power reserve and exceptional speed stability under load.
- ▶ User protection features include kickback stop, restart protection, soft start and electronic overload protection.
- ▶ The lightest model of its kind.
- ▶ Solid metal gearbox head.
- ▶ The best vibration performance in its class.
- ▶ Industrial cable H07, length 4m.

**Price includes:**

1 wheel guard, 1 pair of flanges, 1 anti-vibration handle, 1 key

Grinding

**WSG 17-70 Inox RT**

Ergonomic compact angle grinder with FEIN ErgoGrip for fatigue-free working in stainless steel applications.



For accessories, see page 94

Input	W	1 700
Output	W	1 000
Speed, no load	1/min	2 700 - 8 500
Grinding disc Ø	mm	125
Elast. Backing pad Ø	mm	125
Flange		M 14
Cable with plug	m	4
Weight according to EPTA	kg	2,5
<b>Part number</b>		<b>7 222 23 60 00 0</b>
<b>EAN</b>		<b>4014586883779</b>
<b>Price in € [PC19]</b>		<b>303,45</b>

**FEIN benefits:**

- ▶ FEIN ErgoGrip - Unique ergonomic concept for fatigue-free working (patent pending).
- ▶ POWERtronic for enormous power, power reserve and exceptional speed stability under load.
- ▶ User protection features include kickback stop, restart protection, soft start and electronic overload protection.
- ▶ AutoStop dead man's switch
- ▶ The lightest model of its kind.
- ▶ Solid metal gearbox head.
- ▶ The best vibration performance in its class.
- ▶ Industrial cable H07, length 4m.

**Price includes:**

1 wheel guard, 1 pair of flanges, 1 anti-vibration handle, 1 key

**Compact angle grinders**

**General accessories**



**Work gloves**

Vibration-attenuating, certified according to EN 388/420, EN ISO 10819, EEC No. 0200, No. in pack 1 pair

Size	Part number	Price in €
9 L	3 21 73 003 00 3	72,18
10 XL	3 21 73 004 00 1	72,18
11 XXL	3 21 73 005 00 5	72,18

**General accessories WSG**



**Tool case**

Plastic, inner dimensions: 470 x 275 x 116 mm

Part number	Price in €
3 39 01 118 01 0	37,26



**Plastic box**

Box insert with lockable lid for small parts and accessories, suitable for tool box 3 39 01 118 01 0, max 5 items/box.

Part number	Price in €
3 39 01 119 00 0	3,97



**anti-vibration handle**

M 8, vibration absorbing, to reduce the vibrations during longer jobs.

Part number	Price in €
3 21 19 124 01 0	8,48



**Quick-clamping nut**

to change discs without need for tool, low height of just 8 mm

Part number	Price in €
6 38 02 191 01 0	26,74



**Inner flange**

Part number	Price in €
6 38 01 120 00 6	6,68



**Threaded flange**

M 14, for flexible grinding/cutting discs, fan-pattern grinding wheels and round brush

Part number	Price in €
6 38 02 052 00 0	6,68



**Threaded flange**

M 14, for elastic backing pad and for twisted steel wire brush

Part number	Price in €
6 38 01 154 00 7	6,68



**Elastic backing pad**

with flange M 14, for fibre sanding sheets Ø 125 mm

Ø mm	Part number	Price in €
125	6 38 06 087 01 3	5,57

**Protective covers**



**Wheel guard**

for serrated and roughing discs

Ø mm	Part number	Price in €
115	3 18 10 299 00 0	8,07
125	3 18 10 300 00 0	8,39
150	3 18 10 301 00 0	8,51



**Safety hood for cutting work**

for safe working with cutting wheels

Ø mm	Part number	Price in €
115	6 38 11 016 01 0	27,86
125	6 38 11 017 01 0	27,86
150	6 38 11 018 01 0	27,86

**Accessories for MSfv 649-1**



**Tool case**

metal 700 x 180 x 100 mm

Part number	Price in €
3 39 01 021 01 1	52,00

**Inner flange**

for wheels Ø 125 mm

Part number	Price in €
6 38 01 079 00 9	6,68

**Threaded flange**

M 14, for wheels up to 6 mm

Part number	Price in €
6 38 02 084 00 9	6,68



Grinding

	WSB 20-180	WSB 20-230	WSG 20-180	WSG 20-230	WSB 25-180 X	WSB 25-230 X	WSG 25-180	WSG 25-230
	Powerful safety angle grinder for grinding work.	Powerful safety angle grinder for grinding and cutting work.	Powerful angle grinder for grinding work.	Powerful angle grinder for grinding and cutting work.	The most powerful FEIN safety angle grinder for extreme grinding work.	The most powerful FEIN safety angle grinder for extreme cutting and grinding work.	The most powerful FEIN angle grinder for extreme grinding work.	The most powerful FEIN angle grinder for extreme cutting and grinding work.
Page	96	96	96	97	97	97	98	98
Application	Deburring	▲	▲	▲	▲	▲	▲	▲
	roughing-down	▲▲	▲▲	▲▲	▲▲	▲▲	▲▲	▲▲
	brushing						▲	
	dividing			▲	▲		▲▲	▲▲
Equipment	FEIN high-power motor	●	●	●	●	●	●	●
	Soft start	●	●	●	●	●	●	●
	Restart protection	●	●	●	●	●	●	●
	Brake	●	●			●	●	
AutoStop dead man's switch	+	+	+	+	+	+	+	
Technical features	Input	2 000 W	2 000 W	2 000 W	2 000 W	2 500 W	2 500 W	2 500 W
	Speed, no load	8 500 1/min	6 600 1/min	8 500 1/min	6 600 1/min	8 500 1/min	6 600 1/min	8 500 1/min
	Weight according to EPTA	5,9 kg	5,9 kg	5,6 kg	5,6 kg	6,5 kg	6,7 kg	6,3 kg
	Tool Holder	QuickIN	QuickIN			QuickIN	QuickIN	
	Mounting hole Ø	22,23 mm	22,23 mm			22,23 mm	22,23 mm	
	Flange			M 14	M 14			M 14
	Grinding disc Ø	180 mm	230 mm	180 mm	230 mm	180 mm	230 mm	180 mm
Elast. Backing pad Ø	180 mm	230 mm	180 mm	230 mm	180 mm	230 mm	180 mm	

▲ suitability    ▲▲ optimal suitability    + optional    ● included

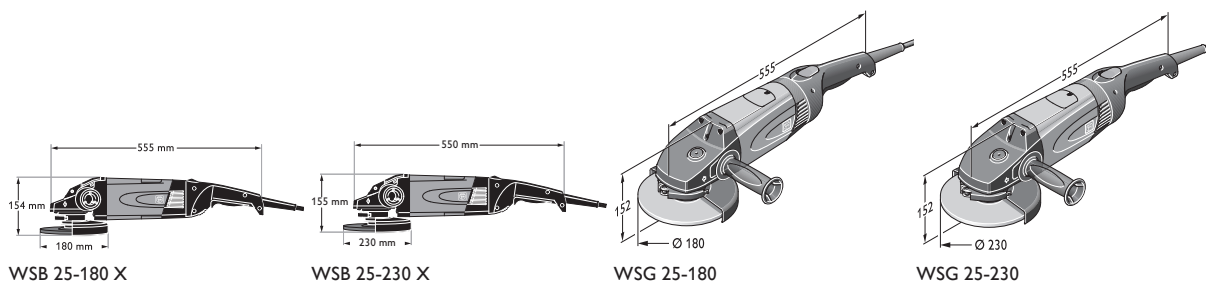

## WSB 20-180

Powerful safety angle grinder for grinding work.



For accessories, see page 99

Input	W	2 000
Output	W	1 250
Speed, no load	1/min	8 500
Grinding disc Ø	mm	180
Tool Holder		QuickIN
Mounting hole Ø	mm	22,23
Elast. Backing pad Ø	mm	180
Weight according to EPTA	kg	5,9
<b>Part number</b>		<b>7 221 05 00 23 7</b>
<b>EAN</b>		<b>4014586851242</b>
<b>Price in € [PC01]</b>		<b>331,80</b>

You will find tools with the AutoStop dead man's switch in the numerical section.

### FEIN benefits:

- ▶ FEIN high-power motor - effective material removal over the entire operating range.
- ▶ Complete safety package with electronic brake system (EBS), restart lock and soft start.
- ▶ Tool-free FEIN QuickIN clamping system safely clamps tools without a key.
- ▶ Rear handle can be rotated through 4 positions.
- ▶ Dustproof ball bearing.
- ▶ Sealed electronic parts.
- ▶ Carbon brushes with self cut-off function.
- ▶ Restart protection.
- ▶ Also available with Auto Stop (with dead-mans switch) for maximum safety (7 221 05 29).

### Price includes:

1 wheel guard, 1 clamp for flexible grinding/cutting discs, 1 additional handle

## WSB 20-230

Powerful safety angle grinder for grinding and cutting work.



For accessories, see page 99

Input	W	2 000
Output	W	1 250
Speed, no load	1/min	6 600
Grinding disc Ø	mm	230
Tool Holder		QuickIN
Mounting hole Ø	mm	22,23
Elast. Backing pad Ø	mm	230
Weight according to EPTA	kg	5,9
<b>Part number</b>		<b>7 221 06 00 23 0</b>
<b>EAN</b>		<b>4014586851259</b>
<b>Price in € [PC01]</b>		<b>331,80</b>

You will find tools with the AutoStop dead man's switch in the numerical section.

### FEIN benefits:

- ▶ FEIN high-power motor - high sanding capacity over the full working range up to 150% load.
- ▶ Complete safety package with electronic brake system (EBS), restart lock and soft start.
- ▶ Tool-free FEIN QuickIN clamping system safely clamps tools without a key.
- ▶ Rear handle can be rotated through 4 positions.
- ▶ Dustproof ball bearing.
- ▶ Sealed electronic parts.
- ▶ Carbon brushes with self cut-off function.
- ▶ Restart protection.
- ▶ Also available with Auto Stop (with dead-mans switch) for maximum safety (7 221 06 29).

### Price includes:

1 wheel guard, 1 clamp for flexible grinding/cutting discs, 1 additional handle

## WSG 20-180

Powerful angle grinder for grinding work.



For accessories, see page 99

Input	W	2 000
Output	W	1 250
Speed, no load	1/min	8 500
Grinding disc Ø	mm	180
Elast. Backing pad Ø	mm	180
Flange		M 14
Weight according to EPTA	kg	5,6
<b>Part number</b>		<b>7 221 07 00 23 6</b>
<b>EAN</b>		<b>4014586851266</b>
<b>Price in € [PC01]</b>		<b>284,55</b>

You will find tools with the AutoStop dead man's switch in the numerical section.

### FEIN benefits:

- ▶ FEIN high-power motor - high sanding capacity over the full working range up to 150% load.
- ▶ Flat drive head allows the tool to be plunged into workpieces.
- ▶ Soft start for safe handling from the word go.
- ▶ Rear handle can be rotated through 4 positions.
- ▶ Dustproof ball bearing.
- ▶ Sealed electronic parts.
- ▶ Carbon brushes with self cut-off function.
- ▶ Restart protection.
- ▶ Also available with Auto Stop (with dead-mans switch) for maximum safety, 230 V only (7 221 07 29).

### Price includes:

1 wheel guard, 1 pair of flanges, 1 additional handle, 1 key



**WSG 20-230**

Powerful angle grinder for grinding and cutting work.



For accessories, see page 99

Input	W	2 000
Output	W	1 250
Speed, no load	1/min	6 600
Grinding disc Ø	mm	230
Elast. Backing pad Ø	mm	230
Flange		M 14
Weight according to EPTA	kg	5,6
<b>Part number</b>		<b>7 221 08 00 23 2</b>
<b>EAN</b>		<b>4014586851273</b>
<b>Price in € [PC01]</b>		<b>288,75</b>

**FEIN benefits:**

- ▶ FEIN high-power motor - high sanding capacity over the full working range up to 150% load.
- ▶ Flat drive head allows the tool to be plunged into workpieces.
- ▶ Soft start for safe handling from the word go.
- ▶ Rear handle can be rotated through 4 positions.
- ▶ Dustproof ball bearing.
- ▶ Sealed electronic parts.
- ▶ Carbon brushes with self cut-off function.
- ▶ Restart protection.
- ▶ Also available with Auto Stop (with dead-mans switch) for maximum safety, 230 V only (7 221 08 29).

**Price includes:**

1 wheel guard, 1 pair of flanges, 1 additional handle, 1 key

You will find tools with the AutoStop dead man's switch in the numerical section.

**WSB 25-180 X**

The most powerful FEIN safety angle grinder for extreme grinding work.



For accessories, see page 99

Input	W	2 500
Output	W	1 700
Speed, no load	1/min	8 500
Grinding disc Ø	mm	180
Tool Holder		QuickIN
Mounting hole Ø	mm	22,23
Elast. Backing pad Ø	mm	180
Weight according to EPTA	kg	6,5
<b>Part number</b>		<b>7 221 10 00 23 3</b>
<b>EAN</b>		<b>4014586853116</b>
<b>Price in € [PC01]</b>		<b>412,65</b>

**FEIN benefits:**

- ▶ The 2 500 W FEIN high-power motor makes this the most powerful FEIN angle grinder with outstanding sanding capacity over the entire working range of up to 150% load.
- ▶ Complete safety package with electronic brake system (EBS), restart lock and soft start.
- ▶ Tool-free FEIN QuickIN clamping system safely clamps tools without a key.
- ▶ Rear handle can be rotated through 4 positions.
- ▶ Dustproof ball bearing.
- ▶ Sealed electronic parts.
- ▶ Carbon brushes with self cut-off function.
- ▶ Restart protection.
- ▶ Also available with Auto Stop (with dead-mans switch) for maximum safety (7 221 10 29).

**Price includes:**

1 wheel guard, 1 clamp for flexible grinding/cutting discs, 1 additional handle

You will find tools with the AutoStop dead man's switch in the numerical section.

**WSB 25-230 X**

The most powerful FEIN safety angle grinder for extreme cutting and grinding work.



For accessories, see page 99

Input	W	2 500
Output	W	1 700
Speed, no load	1/min	6 600
Grinding disc Ø	mm	230
Tool Holder		QuickIN
Mounting hole Ø	mm	22,23
Elast. Backing pad Ø	mm	230
Weight according to EPTA	kg	6,7
<b>Part number</b>		<b>7 221 11 00 23 2</b>
<b>EAN</b>		<b>4014586853123</b>
<b>Price in € [PC01]</b>		<b>412,65</b>

**FEIN benefits:**

- ▶ The 2 500 W FEIN high-power motor makes this the most powerful FEIN angle grinder with outstanding sanding capacity over the entire working range of up to 150% load.
- ▶ Complete safety package with electronic brake system (EBS), restart lock and soft start.
- ▶ Tool-free FEIN QuickIN clamping system safely clamps tools without a key.
- ▶ Rear handle can be rotated through 4 positions.
- ▶ Dustproof ball bearing.
- ▶ Sealed electronic parts.
- ▶ Carbon brushes with self cut-off function.
- ▶ Restart protection.
- ▶ Also available with Auto Stop (with dead-mans switch) for maximum safety (7 221 11 29).

**Price includes:**

1 wheel guard, 1 clamp for flexible grinding/cutting discs, 1 additional handle

You will find tools with the AutoStop dead man's switch in the numerical section.

Grinding

## WSG 25-180



For accessories, see page 99

The most powerful FEIN angle grinder for extreme grinding work.

Input	W	2 500
Output	W	1 700
Speed, no load	1/min	8 500
Grinding disc Ø	mm	180
Elast. Backing pad Ø	mm	180
Flange		M 14
Weight according to EPTA	kg	6,3
<b>Part number</b>		<b>7 221 26 00 23 0</b>
<b>EAN</b>		<b>4014586856452</b>
<b>Price in € [PC01]</b>		<b>367,50</b>

You will find tools with the AutoStop dead man's switch in the numerical section.

### FEIN benefits:

- ▶ The 2 500 W FEIN high-power motor makes this the most powerful FEIN angle grinder with outstanding sanding capacity over the entire working range of up to 150% load.
- ▶ Flat drive head allows the tool to be plunged into workpieces.
- ▶ Soft start for safe handling from the word go.
- ▶ Rear handle can be rotated through 4 positions.
- ▶ Dustproof ball bearing.
- ▶ Sealed electronic parts.
- ▶ Carbon brushes with self cut-off function.
- ▶ Restart protection.
- ▶ Also available with Auto Stop (with dead-mans switch) for maximum safety (7 221 26 29).

### Price includes:

1 wheel guard, 1 pair of flanges, 1 additional handle, 1 key

## WSG 25-230



For accessories, see page 99

The most powerful FEIN angle grinder for extreme cutting and grinding work.

Input	W	2 500
Output	W	1 700
Speed, no load	1/min	6 600
Grinding disc Ø	mm	230
Elast. Backing pad Ø	mm	230
Flange		M 14
Weight according to EPTA	kg	6,3
<b>Part number</b>		<b>7 221 27 00 23 0</b>
<b>EAN</b>		<b>4014586856506</b>
<b>Price in € [PC01]</b>		<b>367,50</b>

You will find tools with the AutoStop dead man's switch in the numerical section.

### FEIN benefits:

- ▶ The 2 500 W FEIN high-power motor makes this the most powerful FEIN angle grinder with outstanding sanding capacity over the entire working range of up to 150% load.
- ▶ Flat drive head allows the tool to be plunged into complex workpieces.
- ▶ Soft start for safe handling from the word go.
- ▶ Rear handle can be rotated through 4 positions.
- ▶ Dustproof ball bearing.
- ▶ Sealed electronic parts.
- ▶ Carbon brushes with self cut-off function.
- ▶ Restart protection.
- ▶ Also available with Auto Stop (with dead-mans switch) for maximum safety (7 221 27 29).

### Price includes:

1 key, 1 wheel guard, 1 pair of flanges, 1 additional handle





**General accessories**



**Tool case**  
Metal

Width mm	Length mm	Height mm	Part number	Price in €
240	690	160	3 39 01 022 01 4	47,78



**anti-vibration handle**  
M 14, vibration absorbing, to reduce the vibrations during longer jobs.

Part number	Price in €
3 21 19 117 01 5	34,09



**Work gloves**  
Vibration-attenuating, certified according to EN 388/420, EN ISO 10819, EEC No. 0200, No. in pack 1 pair

Size	Part number	Price in €
9 L	3 21 73 003 00 3	72,18
10 XL	3 21 73 004 00 1	72,18
11 XXL	3 21 73 005 00 5	72,18



**Connecting piece**  
Universal device to connect power tools and accessories with dust extraction to vacuum cleaner. Flexible rubber sleeve, length 70 mm, inner diameter 31.5 mm.

Part number	Price in €
3 13 22 771 00 9	4,91

**Protective covers**



**Safety hood for cutting work**

Ø mm	Part number	Price in €
180	6 38 11 004 01 0	29,85
230	6 38 11 005 01 0	30,73



**Protective suction hood**  
with guide block for cutting discs Ø 180 mm cutting depth 40 mm, connection Ø 32 mm

Part number	Price in €
9 06 04 008 01 3	228,12



**Protective suction hood**  
with guide block for cutting discs Ø 230 mm cutting depth 65 mm, connection Ø 32 mm

Part number	Price in €
9 06 04 009 01 7	235,62

**Accessories for WSB**



**Clamping unit**  
for flexible grinding/cutting discs as well as for fan-pattern wheels

Part number	Price in €
6 38 02 183 02 5	35,57



**Elastic backing pad**  
with clamping unit

Ø mm	Part number	Price in €
180	6 38 06 174 02 8	45,91



**Elastic backing pad**  
without clamping unit

Ø mm	Part number	Price in €
180	6 38 06 174 01 2	16,07



**Clamping unit**  
for elastic backing pads

Part number	Price in €
6 38 02 185 02 7	35,57

**Accessories for WSG**



**Threaded flange**  
M 14, for flexible grinding/cutting discs, fan-pattern grinding wheels and round brush

Part number	Price in €
6 38 02 052 00 0	6,68



**Inner flange**

Part number	Price in €
6 38 01 120 00 6	6,68



**Elastic backing pad**  
with flange M 14

Ø mm	Part number	Price in €
180	6 38 06 034 01 7	11,62



**Threaded flange**  
M 14, for elastic backing pad and for twisted steel wire brush

Part number	Price in €
6 38 01 154 00 7	6,68



	GSZ 8-280 P	GSZ 8-280 PE	GSZ 8-280 PL	GSZ 8-280 PEL	GSZ 8-90 PEL	
	Ergonomic, powerful die grinder for grinding and deburring in difficult-to-reach spots; also suitable for semi-stationary use.		Ergonomic, powerful die grinder with high plunge depth for grinding and deburring in difficult-to-reach spots.		Ergonomic, powerful die grinder for stainless steel processing with high plunge depth for grinding and polishing in especially difficult-to-reach spots.	
Page	102	102	102	103	103	
Application	satin-finishing				▲▲	
	brushing		▲		▲▲	
	polishing				▲▲	
	cutting	▲▲	▲▲	▲▲	▲▲	
	Grinding	▲▲	▲▲	▲▲	▲▲	▲▲
	roughing-down		▲▲	▲▲	▲▲	
	Deburring		▲	▲	▲	
	dividing					
Technical features	Input	750 W	750 W	750 W	750 W	750 W
	Speed, no load	28 000 1/min	8 500 - 28 000 1/min	28 000 1/min	8 500 - 28 000 1/min	8 500 1/min
	Weight according to EPTA	1,4 kg	1,4 kg	1,8 kg	1,8 kg	1,8 kg
	Collet for max. Ø	8 mm	8 mm	8 mm	8 mm	8 mm
	Grinding wheel for max. Ø	45 mm	50 mm		50 mm	50 mm
	Long neck			●	●	●

▲ suitability    ▲▲ optimal suitability    ● included

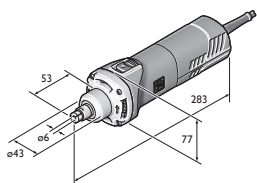

GSZ 8-280 P  
GSZ 8-280 PE  
GSZ 8-280 PEL

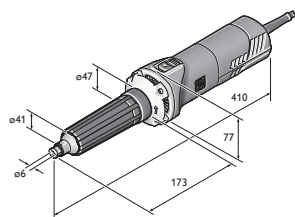

GSZ 8-280 PL

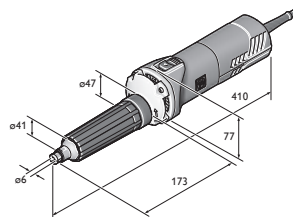

GSZ 8-90 PEL

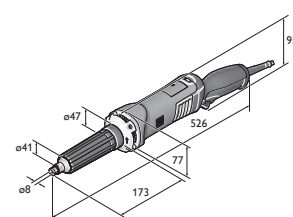

GSZ 11-320 PERL  
GSZ 11-320 PRL

	GSZ 11-320 PRL	GSZ 11-320 PERL	GSZ 11-90 PERL	GSZ 4-280 EL	GSZ 4-90 EL
	Ergonomic, extremely powerful die grinder with high plunge depth for heavy-duty grinding and deburring in difficult-to-reach spots.		Ergonomic, extremely powerful die grinder for stainless steel processing with high plunge depth for heavy-duty grinding and polishing.	Extremely ergonomic die grinder with high plunge depth for light grinding and deburring in especially difficult-to-reach spots.	Extremely ergonomic die grinder for stainless steel processing with high plunge depth for light grinding and polishing in especially difficult-to-reach spots.
	103	104	104	104	105
			▲▲		▲▲
	▲	▲	▲▲	▲	▲▲
			▲▲		▲▲
	▲▲	▲▲		▲▲	
	▲▲	▲▲	▲▲	▲▲	
	▲▲	▲▲		▲▲	▲▲
	▲	▲		▲	
			▲		
	1 010 W	1 010 W	1 010 W	350 W	350 W
	32 500 1/min	9 500 - 32 500 1/min	2 900 - 9 900 1/min	13 000 - 28 000 1/min	3 500 - 8 500 1/min
	2,1 kg	2,1 kg	2,2 kg	1,5 kg	1,5 kg
	8 mm	8 mm	8 mm	6 mm	6 mm
	45 mm	45 mm	50 mm	20 mm	20 mm
	●	●	●	●	●

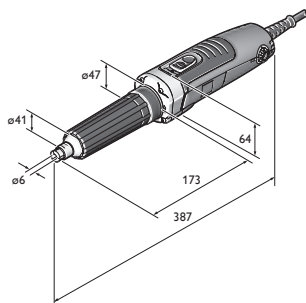

GSZ 4-280 EL

**GSZ 8-280 P**

Ergonomic, powerful die grinder for grinding and deburring in difficult-to-reach spots; also suitable for semi-stationary use.



For accessories, see page 105

Input	W	750
Output	W	400
Speed, no load	1/min	28 000
Grinding wheel for max. Ø	mm	45
Collet for max. Ø	mm	8
Collar Ø	mm	43
Max. cutter diameter	mm	12
Cable with plug	m	4
Weight according to EPTA	kg	1,4
<b>Part number</b>	<b>7 223 16 60 00 0</b>	
<b>EAN</b>	<b>4014586879505</b>	
<b>Price in € [PC01]</b>	<b>217,35</b>	

**FEIN benefits:**

- ▶ Compact design for use in especially tight spaces, collar diameter of 43 mm for semi-stationary use as milling motor (e.g. as profile miller).
- ▶ User protection features include kickback stop, restart protection, soft start and electronic overload protection.
- ▶ Innovative collets with all-round flange to protect the workpiece and prevent the wrench sliding off during tool changes.
- ▶ POWERtronic tachoelectronics for enormous power, power reserve and exceptional speed stability under load.
- ▶ Motor and electronics protected against metal dust.

**Price includes:**

1 collet Ø 6 mm, Jaw spanner SW13, Jaw spanner SW17

**GSZ 8-280 PE**

Ergonomic, powerful die grinder for grinding and deburring in difficult-to-reach spots; also suitable for semi-stationary use.



For accessories, see page 105

Input	W	750
Output	W	400
Speed, no load	1/min	8 500 - 28 000
Grinding wheel for max. Ø	mm	50
Collet for max. Ø	mm	8
Collar Ø	mm	43
Max. cutter diameter	mm	12
Cable with plug	m	4
Weight according to EPTA	kg	1,4
<b>Part number</b>	<b>7 223 17 60 00 0</b>	
<b>EAN</b>	<b>4014586879437</b>	
<b>Price in € [PC01]</b>	<b>238,35</b>	

**FEIN benefits:**

- ▶ Compact design for use in especially tight spaces, collar diameter of 43 mm for semi-stationary use as milling motor (e.g. as profile miller).
- ▶ User protection features include kickback stop, restart protection, soft start and electronic overload protection.
- ▶ Innovative collets with all-round flange to protect the workpiece and prevent the wrench sliding off during tool changes.
- ▶ Variable speed allows different tools to be used.
- ▶ POWERtronic tachoelectronics for enormous power, power reserve and exceptional speed stability under load.
- ▶ Motor and electronics protected against metal dust.

**Price includes:**

1 collet Ø 6 mm, Jaw spanner SW13, Jaw spanner SW17

**GSZ 8-280 PL**

Ergonomic, powerful die grinder with high plunge depth for grinding and deburring in difficult-to-reach spots.



For accessories, see page 105

Input	W	750
Output	W	410
Speed, no load	1/min	28 000
Collet for max. Ø	mm	8
Collar Ø	mm	43
Max. cutter diameter	mm	12
Cable with plug	m	4
Weight according to EPTA	kg	1,8
<b>Part number</b>	<b>7 223 18 60 00 0</b>	
<b>EAN</b>	<b>4014586879598</b>	
<b>Price in € [PC01]</b>	<b>391,65</b>	

**FEIN benefits:**

- ▶ Long narrow neck allows tool to plunge a long way into workpieces (e.g. grinding inside pipes).
- ▶ User protection features include kickback stop, restart protection, soft start and electronic overload protection.
- ▶ Innovative collets with all-round flange to protect the workpiece and prevent the wrench sliding off during tool changes.
- ▶ POWERtronic tachoelectronics for enormous power, power reserve and exceptional speed stability under load.
- ▶ Removable rubber collar bearing cover.
- ▶ Motor and electronics protected against metal dust.

**Price includes:**

Jaw spanner SW13, 1 collet Ø 6 mm, Jaw spanner SW17

**GSZ 8-280 PEL**

Ergonomic, powerful die grinder with high plunge depth for grinding and deburring in difficult-to-reach spots.



For accessories, see page 105

Input	W	750
Output	W	410
Speed, no load	1/min	8 500 - 28 000
Grinding wheel for max. Ø	mm	50
Collet for max. Ø	mm	8
Collar Ø	mm	43
Max. cutter diameter	mm	12
Cable with plug	m	4
Weight according to EPTA	kg	1,8
<b>Part number</b>		<b>7 223 19 60 00 0</b>
<b>EAN</b>		<b>4014586879444</b>
<b>Price in € [PC01]</b>		<b>414,75</b>

**FEIN benefits:**

- ▶ Long narrow neck allows tool to plunge a long way into workpieces (e.g. grinding inside pipes).
- ▶ User protection features include kickback stop, restart protection, soft start and electronic overload protection.
- ▶ Innovative collets with all-round flange to protect the workpiece and prevent the wrench sliding off during tool changes.
- ▶ Variable speed allows different tools to be used.
- ▶ POWERtronic tachoelectronics for enormous power, power reserve and exceptional speed stability under load.
- ▶ Removable rubber collar bearing cover.
- ▶ Motor and electronics protected against metal dust.

**Price includes:**

1 collet Ø 6 mm, Jaw spanner SW13, Jaw spanner SW17

**GSZ 8-90 PEL**

Ergonomic, powerful die grinder for stainless steel processing with high plunge depth for grinding and polishing in especially difficult-to-reach spots.



For accessories, see page 105

Input	W	750
Output	W	410
Speed, no load	1/min	8 500
Grinding wheel for max. Ø	mm	50
Collet for max. Ø	mm	8
Collar Ø	mm	43
Max. cutter diameter	mm	12
Cable with plug	m	4
Weight according to EPTA	kg	1,8
<b>Part number</b>		<b>7 223 20 60 00 0</b>
<b>EAN</b>		<b>4014586879451</b>
<b>Price in € [PC01]</b>		<b>490,35</b>

**FEIN benefits:**

- ▶ Long narrow neck allows tool to plunge a long way into workpieces (e.g. grinding inside pipes).
- ▶ User protection features include kickback stop, restart protection, soft start and electronic overload protection.
- ▶ Innovative collets with all-round flange to protect the workpiece and prevent the wrench sliding off during tool changes.
- ▶ POWERtronic tachoelectronics for enormous power, power reserve and exceptional speed stability under load.
- ▶ Removable rubber collar bearing cover.
- ▶ Motor and electronics protected against metal dust.

**Price includes:**

1 collet Ø 6 mm, Jaw spanner SW13, Jaw spanner SW17

**GSZ 11-320 PRL**

Ergonomic, extremely powerful die grinder with high plunge depth for heavy-duty grinding and deburring in difficult-to-reach spots.



For accessories, see page 105

Input	W	1 010
Output	W	620
Speed, no load	1/min	32 500
Grinding wheel for max. Ø	mm	45
Collet for max. Ø	mm	8
Collar Ø	mm	43
Max. cutter diameter	mm	12
Cable with plug	m	4
Weight according to EPTA	kg	2,1
<b>Part number</b>		<b>7 223 21 60 00 0</b>
<b>EAN</b>		<b>4014586880495</b>
<b>Price in € [PC01]</b>		<b>425,25</b>

**FEIN benefits:**

- ▶ Long narrow neck allows tool to plunge a long way into workpieces (e.g. grinding inside pipes).
- ▶ User protection features include kickback stop, restart protection, soft start and electronic overload protection.
- ▶ Innovative collets with all-round flange to protect the workpiece and prevent the wrench sliding off during tool changes.
- ▶ POWERtronic tachoelectronics for enormous power, power reserve and exceptional speed stability under load.
- ▶ Removable rubber collar bearing cover.
- ▶ Motor and electronics protected against metal dust.

**Price includes:**

1 collet Ø 8 mm, Jaw spanner SW13, Jaw spanner SW17

**GSZ 11-320 PERL**

Ergonomic, extremely powerful die grinder with high plunge depth for heavy-duty grinding and deburring in difficult-to-reach spots.



For accessories, see page 105

Input	W	1 010
Output	W	620
Speed, no load	1/min	9 500 - 32 500
Grinding wheel for max. Ø	mm	45
Collet for max. Ø	mm	8
Collar Ø	mm	43
Max. cutter diameter	mm	12
Cable with plug	m	4
Weight according to EPTA	kg	2,1
<b>Part number</b>		<b>7 223 22 60 00 0</b>
<b>EAN</b>		<b>4014586880501</b>
<b>Price in € [PC01]</b>		<b>446,25</b>

**FEIN benefits:**

- ▶ Long narrow neck allows tool to plunge a long way into workpieces (e.g. grinding inside pipes).
- ▶ User protection features include kickback stop, restart protection, soft start and electronic overload protection.
- ▶ Innovative collets with all-round flange to protect the workpiece and prevent the wrench sliding off during tool changes.
- ▶ Variable speed allows different tools to be used.
- ▶ POWERtronic tachoelectronics for enormous power, power reserve and exceptional speed stability under load.
- ▶ Removable rubber collar bearing cover.
- ▶ Motor and electronics protected against metal dust.

**Price includes:**

1 collet Ø 8 mm, Jaw spanner SW13, Jaw spanner SW17

**GSZ 11-90 PERL**

Ergonomic, extremely powerful die grinder for stainless steel processing with high plunge depth for heavy-duty grinding and polishing.



For accessories, see page 105

Input	W	1 010
Output	W	620
Speed, no load	1/min	2 900 - 9 900
Polishing disc Ø	mm	80
Grinding wheel for max. Ø	mm	50
Collet for max. Ø	mm	8
Collar Ø	mm	43
Max. cutter diameter	mm	12
Cable with plug	m	4
Weight according to EPTA	kg	2,2
<b>Part number</b>		<b>7 223 23 60 00 0</b>
<b>EAN</b>		<b>4014586880525</b>
<b>Price in € [PC01]</b>		<b>523,95</b>

**FEIN benefits:**

- ▶ Long narrow neck allows tool to plunge a long way into workpieces (e.g. grinding inside pipes).
- ▶ User protection features include kickback stop, restart protection, soft start and electronic overload protection.
- ▶ Innovative collets with all-round flange to protect the workpiece and prevent the wrench sliding off during tool changes.
- ▶ Variable speed allows different tools to be used.
- ▶ POWERtronic tachoelectronics for enormous power, power reserve and exceptional speed stability under load.
- ▶ Removable rubber collar bearing cover.
- ▶ Motor and electronics protected against metal dust.

**Price includes:**

1 collet Ø 8 mm, Jaw spanner SW13, Jaw spanner SW17

**GSZ 4-280 EL**

Extremely ergonomic die grinder with high plunge depth for light grinding and deburring in especially difficult-to-reach spots.



For accessories, see page 105

Input	W	350
Output	W	170
Speed, no load	1/min	13 000 - 28 000
Grinding wheel for max. Ø	mm	20
Collet for max. Ø	mm	6
Collar Ø	mm	43
Max. cutter diameter	mm	12
Cable with plug	m	5
Weight according to EPTA	kg	1,5
<b>Part number</b>		<b>7 223 24 60 00 0</b>
<b>EAN</b>		<b>4014586880594</b>
<b>Price in € [PC01]</b>		<b>385,35</b>

**FEIN benefits:**

- ▶ Long narrow neck and maximum diameter of 210 mm allows tool to plunge a long way into workpieces (e.g. grinding inside pipes).
- ▶ Innovative collets with all-round flange to protect the workpiece and prevent the wrench sliding off during tool changes.
- ▶ Variable speed allows different tools to be used.
- ▶ Motor and electronics protected against metal dust.
- ▶ Removable rubber collar bearing cover.

**Price includes:**

1 collet Ø 6 mm, Jaw spanner SW13, Jaw spanner SW17



**GSZ 4-90 EL**

Extremely ergonomic die grinder for stainless steel processing with high plunge depth for light grinding and polishing in especially difficult-to-reach spots.



For accessories, see page 105

Input	W	350
Output	W	170
Speed, no load	1/min	3 500 - 8 500
Polishing disc Ø	mm	50
Grinding wheel for max. Ø	mm	20
Collet for max. Ø	mm	6
Max. cutter diameter	mm	12
Cable with plug	m	5
Weight according to EPTA	kg	1,5
<b>Part number</b>	<b>7 223 25 60 0 0</b>	
<b>EAN</b>	<b>4014586880648</b>	
<b>Price in € [PC01]</b>	<b>385,35</b>	

**FEIN benefits:**

- ▶ Variable speed allows different tools to be used.
- ▶ Long narrow neck and maximum diameter of 210 mm allows tool to plunge a long way into workpieces (e.g. grinding inside pipes).
- ▶ Innovative collets with all-round flange to protect the workpiece and prevent the wrench sliding off during tool changes.
- ▶ Removable rubber collar bearing cover.
- ▶ Motor and electronics protected against metal dust.

**Price includes:**

Jaw spanner SW17, 1 collet Ø 6 mm, Jaw spanner SW13

**Die Grinders**

**Collets for GSZ 4, GSZ 8, GSZ 11**



**Collets**

With all-round flange to protect the workpiece and prevent the wrench sliding off during tool changes.

Ø mm	Part number	Price in €
3	6 32 07 130 00 0	20,76
6	6 32 07 128 00 0	20,76
8	6 32 07 129 00 0	20,76
6,35	6 32 07 131 00 0	20,76



**Collets Inox**

Stainless steel model, with all-round flange to protect the workpiece and prevent the wrench sliding off during tool changes.

Ø mm	Part number	Price in €
3	6 32 07 132 00 0	24,03
6	6 32 07 133 00 0	24,03
8	6 32 07 134 00 0	24,03
6,35	6 32 07 135 00 0	24,03

**Collets for MSh 635**



**Collets**

Ø mm	Part number	Price in €
3	6 32 07 097 00 0	22,74
6	6 32 07 103 00 9	22,74

**Collets for MSh 636-1, MSh 648-1, MSHe 648-1, MShy 648-1Z**



**Collets**

Depth 30 mm

Ø mm	Part number	Price in €
3	6 32 07 087 00 1	22,74
6	6 32 07 059 00 6	22,74
8	6 32 07 069 00 5	22,74
6,35	6 32 07 088 00 9	22,74

**General accessories**



**Tool case**

Plastic, inner dimensions: 470 x 275 x 116 mm

Part number	Price in €
3 39 01 118 01 0	37,26



**Plastic box**

Box insert with lockable lid for small parts and accessories, suitable for tool box 3 39 01 118 01 0, max 5 items/box.

Part number	Price in €
3 39 01 119 00 0	3,97





	MSfo 869-1c 300 Hz 200 V	MSfo 869-1d 300 Hz 200 V	MSfo 852-1c 300 Hz 200 V	MSfo 852-1d 300 Hz 200 V	MSfo 870-1c 300 Hz 200 V	MSfo 870-1d 300 Hz 200 V	
	Powerful HF angle grinder for heavy-duty cutting and grinding work.	Powerful HF angle grinder for heavy-duty grinding work.	Powerful HF angle grinder for medium- to heavy-duty grinding and brushing work.		The most powerful FEIN HF angle grinder for extreme cutting and grinding work.	The most powerful FEIN HF angle grinder for extreme grinding work.	
<b>Page</b>	108	108	108	108	109	109	
<b>Application</b>	roughing-down	▲▲	▲▲	▲▲	▲▲	▲▲	
	Deburring	▲	▲	▲	▲	▲	
	dividing	▲▲	▲	▲	▲	▲▲	
<b>Technical features</b>	Frequency	300 Hz	300 Hz	300 Hz	300 Hz	300 Hz	
	Voltage/type of current	200 V/3~	200 V/3~	200 V/3~	200 V/3~	200 V/3~	
	Input	3 100 W	3 100 W	1 900 W	1 900 W	3 700 W	3 700 W
	Output	2 450 W	2 450 W	1 400 W	1 400 W	2 800 W	2 800 W
	Speed, no load	6 500 1/min	8 600 1/min	6 400 1/min	8 500 1/min	6 600 1/min	8 600 1/min
	Cable	5 m	5 m	5 m	5 m	5 m	5 m
	Weight according to EPTA	7,7 kg	7,4 kg	6,3 kg	5,9 kg	8,5 kg	8,2 kg
	Flange	M 14	M 14	M 14	M 14	M 14	M 14
	Grinding disc Ø	230 mm	180 mm	230 mm	180 mm	230 mm	180 mm
Elast. Backing pad Ø	180 mm	180 mm	180 mm	180 mm	180 mm	180 mm	

▲ suitability    ▲▲ optimal suitability



MSfo 869-1c  
MSfo 869-1d



MSfo 852-1c  
MSfo 852-1d



MSfo 870-1c



MSfo 870-1d

	<b>MSfo 849-1c</b> 300 Hz 200 V	<b>MSfov 852-1</b> 300 Hz 200 V	<b>MSf 843-1c</b> 300 Hz 200 V	<b>HFw 9-125</b> 300 Hz 200 V	<b>MSfov 852-1-180</b> 300 Hz 200 V
	Powerful HF angle grinder for medium-duty grinding work.	Long-neck HF angle grinder for hard-to-reach places.	Powerful HF compact angle grinder for medium-duty grinding and deburring work.	Handy HF compact angle grinder for light-duty grinding and deburring work.	Long-neck HF angle grinder for hard-to-reach places.
	109	109	110	110	110
		▲▲	▲▲		▲▲
		▲	▲		▲
			▲		
	300 Hz	300 Hz	300 Hz	300 Hz	300 Hz
	200 V/3~	200 V/3~	200 V/3~	200 V/3~	200 V/3~
	1 500 W	1 900 W	1 100 W	900 W	1 900 W
	1 075 W	1 400 W	700 W	690 W	1 400 W
	6 150 1/min	8 800 1/min	6 500 1/min	7 100 1/min	7 450 1/min
	5 m	5 m	5 m	5 m	5 m
	5,1 kg	5,2 kg	3,6 kg	2,5 kg	5,3 kg
	M 14	M 14	M 14		M 14
	180 mm	125 mm	125 mm	125 mm	180 mm
	180 mm		125 mm	125 mm	



MSfov 852-1



MSf 843-1c

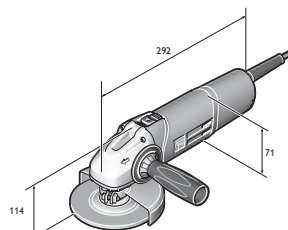

HFw 9-125

## MSfo 869-1c 300 Hz 200 V

Powerful HF angle grinder for heavy-duty cutting and grinding work.



For accessories, see page 118

Input	W	3 100
Output	W	2 450
Frequency	Hz	300
Voltage/type of current	V/3~	200
Speed, no load	1/min	6 500
Grinding disc Ø	mm	230
Elast. Backing pad Ø	mm	180
Flange		M 14
Cable	m	5
Weight according to EPTA	kg	7,7
<b>Part number</b>		<b>7 820 62 00 26 0</b>
<b>EAN</b>		<b>401458656759</b>
<b>Price in € [PC09]</b>		<b>1.191,75</b>

### FEIN benefits:

- ▶ Metal motor and gearbox housing for maximum load capacity in industrial continuous use.
- ▶ Fully encapsulated motor, 100% dust protection with surface cooling for maximum stability and service life even under extreme conditions of use.
- ▶ Low-wear and low-maintenance.
- ▶ Maximum reliability and outstanding service life.
- ▶ High effective output.
- ▶ Great speed consistency.

### Price includes:

1 wheel guard, 1 pair of flanges, 1 set of keys, 1 anti-vibration handle

You will find other frequencies and voltages in the numerical section.

## MSfo 869-1d 300 Hz 200 V

Powerful HF angle grinder for heavy-duty grinding work.



For accessories, see page 118

Input	W	3 100
Output	W	2 450
Frequency	Hz	300
Voltage/type of current	V/3~	200
Speed, no load	1/min	8 600
Grinding disc Ø	mm	180
Elast. Backing pad Ø	mm	180
Flange		M 14
Cable	m	5
Weight according to EPTA	kg	7,4
<b>Part number</b>		<b>7 820 65 00 26 0</b>
<b>EAN</b>		<b>4014586856834</b>
<b>Price in € [PC09]</b>		<b>1.191,75</b>

### FEIN benefits:

- ▶ Metal motor and gearbox housing for maximum load capacity in industrial continuous use.
- ▶ Fully encapsulated motor, 100% dust protection with surface cooling for maximum stability and service life even under extreme conditions of use.
- ▶ Low-wear and low-maintenance.
- ▶ High effective output.
- ▶ Great speed consistency.
- ▶ Maximum reliability and outstanding service life.

### Price includes:

1 wheel guard, 1 pair of flanges, 1 set of keys, 1 anti-vibration handle

You will find other frequencies and voltages in the numerical section.

## MSfo 852-1c 300 Hz 200 V

Powerful HF angle grinder for medium- to heavy-duty grinding and brushing work.



For accessories, see page 118

Input	W	1 900
Output	W	1 400
Frequency	Hz	300
Voltage/type of current	V/3~	200
Speed, no load	1/min	6 400
Grinding disc Ø	mm	230
Elast. Backing pad Ø	mm	180
Flange		M 14
Cable	m	5
Weight according to EPTA	kg	6,3
<b>Part number</b>		<b>7 820 71 00 26 0</b>
<b>EAN</b>		<b>4014586856933</b>
<b>Price in € [PC09]</b>		<b>1.044,75</b>

### FEIN benefits:

- ▶ Metal motor and gearbox housing for maximum load capacity in industrial continuous use.
- ▶ Fully encapsulated motor, 100% dust protection with surface cooling for maximum stability and service life even under extreme conditions of use.
- ▶ Low-wear and low-maintenance.
- ▶ Maximum reliability and outstanding service life.
- ▶ High effective output.
- ▶ Great speed consistency.

### Price includes:

1 wheel guard, 1 pair of flanges, 1 set of keys, 1 anti-vibration handle

You will find other frequencies and voltages in the numerical section.

## MSfo 852-1d 300 Hz 200 V

Powerful HF angle grinder for medium- to heavy-duty grinding and brushing work.



For accessories, see page 118

Input	W	1 900
Output	W	1 400
Frequency	Hz	300
Voltage/type of current	V/3~	200
Speed, no load	1/min	8 500
Grinding disc Ø	mm	180
Elast. Backing pad Ø	mm	180
Flange		M 14
Cable	m	5
Weight according to EPTA	kg	5,9
<b>Part number</b>		<b>7 820 73 00 26 0</b>
<b>EAN</b>		<b>4014586856971</b>
<b>Price in € [PC09]</b>		<b>1.023,75</b>

### FEIN benefits:

- ▶ Metal motor and gearbox housing for maximum load capacity in industrial continuous use.
- ▶ Fully encapsulated motor, 100% dust protection with surface cooling for maximum stability and service life even under extreme conditions of use.
- ▶ Low-wear and low-maintenance.
- ▶ Maximum reliability and outstanding service life.
- ▶ High effective output.
- ▶ Great speed consistency.

### Price includes:

1 wheel guard, 1 pair of flanges, 1 set of keys, 1 anti-vibration handle

You will find other frequencies and voltages in the numerical section.



**MSfo 870-1c 300 Hz 200 V**

The most powerful FEIN HF angle grinder for extreme cutting and grinding work.



For accessories, see page 118

Input	W	3 700
Output	W	2 800
Frequency	Hz	300
Voltage/type of current	V/3~	200
Speed, no load	1/min	6 600
Grinding disc Ø	mm	230
Elast. Backing pad Ø	mm	180
Flange		M 14
Cable	m	5
Weight according to EPTA	kg	8,5
<b>Part number</b>		<b>7 820 75 00 26 0</b>
<b>EAN</b>		<b>4014586857053</b>
<b>Price in € [PC09]</b>		<b>1.380,75</b>

**FEIN benefits:**

- ▶ Metal motor and gearbox housing for maximum load capacity in industrial continuous use.
- ▶ Fully encapsulated motor, 100% dust protection with surface cooling for maximum stability and service life even under extreme conditions of use.
- ▶ Low-wear and low-maintenance.
- ▶ Maximum reliability and outstanding service life.
- ▶ High effective output.
- ▶ Great speed consistency.

**Price includes:**

1 wheel guard, 1 pair of flanges, 1 set of keys, 1 anti-vibration handle

You will find other frequencies and voltages in the numerical section.

**MSfo 870-1d 300 Hz 200 V**

The most powerful FEIN HF angle grinder for extreme grinding work.



For accessories, see page 118

Input	W	3 700
Output	W	2 800
Frequency	Hz	300
Voltage/type of current	V/3~	200
Speed, no load	1/min	8 600
Grinding disc Ø	mm	180
Elast. Backing pad Ø	mm	180
Flange		M 14
Cable	m	5
Weight according to EPTA	kg	8,2
<b>Part number</b>		<b>7 820 77 00 26 0</b>
<b>EAN</b>		<b>4014586857107</b>
<b>Price in € [PC09]</b>		<b>1.380,75</b>

**FEIN benefits:**

- ▶ Metal motor and gearbox housing for maximum load capacity in industrial continuous use.
- ▶ Fully encapsulated motor, 100% dust protection with surface cooling for maximum stability and service life even under extreme conditions of use.
- ▶ Low-wear and low-maintenance.
- ▶ Maximum reliability and outstanding service life.
- ▶ High effective output.
- ▶ Great speed consistency.

**Price includes:**

1 wheel guard, 1 pair of flanges, 1 set of keys, 1 anti-vibration handle

You will find other frequencies and voltages in the numerical section.

**MSfo 849-1c 300 Hz 200 V**

Powerful HF angle grinder for medium-duty grinding work.



For accessories, see page 118

Input	W	1 500
Output	W	1 075
Frequency	Hz	300
Voltage/type of current	V/3~	200
Speed, no load	1/min	6 150
Grinding disc Ø	mm	180
Elast. Backing pad Ø	mm	180
Flange		M 14
Cable	m	5
Weight according to EPTA	kg	5,1
<b>Part number</b>		<b>7 820 80 00 26 0</b>
<b>EAN</b>		<b>4014586857145</b>
<b>Price in € [PC09]</b>		<b>1.055,25</b>

**FEIN benefits:**

- ▶ Metal motor and gearbox housing for maximum load capacity in industrial continuous use.
- ▶ Fully encapsulated motor, 100% dust protection with surface cooling for maximum stability and service life even under extreme conditions of use.
- ▶ Low-wear and low-maintenance.
- ▶ Maximum reliability and outstanding service life.
- ▶ Great speed consistency.
- ▶ High effective output.

**Price includes:**

1 anti-vibration handle, 1 set of keys, 1 wheel guard, 1 pair of flanges

You will find other frequencies and voltages in the numerical section.

**MSfov 852-1 300 Hz 200 V**

Long-neck HF angle grinder for hard-to-reach places.



For accessories, see page 118

Input	W	1 900
Output	W	1 400
Frequency	Hz	300
Voltage/type of current	V/3~	200
Speed, no load	1/min	8 800
Grinding disc Ø	mm	125
Flange		M 14
Cable	m	5
Weight according to EPTA	kg	5,2
<b>Part number</b>		<b>7 820 83 00 26 0</b>
<b>EAN</b>		<b>4014586857336</b>
<b>Price in € [PC09]</b>		<b>1.328,25</b>

**FEIN benefits:**

- ▶ Low profile gearbox head 65 mm in height, including grinding disc.
- ▶ Metal motor and gearbox housing for maximum load capacity in industrial continuous use.
- ▶ Fully encapsulated motor, 100% dust protection with surface cooling for maximum stability and service life even under extreme conditions of use.
- ▶ Low-wear and low-maintenance.
- ▶ Maximum reliability and outstanding service life.
- ▶ High effective output.
- ▶ Great speed consistency.

**Price includes:**

1 wheel guard, 1 pair of flanges, 1 set of keys

You will find other frequencies and voltages in the numerical section.

## MSf 843-1c 300 Hz 200 V



For accessories, see page 118

Powerful HF compact angle grinder for medium-duty grinding and deburring work.

Input	W	1 100
Output	W	700
Frequency	Hz	300
Voltage/type of current	V/3~	200
Speed, no load	1/min	6 500
Grinding disc Ø	mm	125
Elast. Backing pad Ø	mm	125
Flange		M 14
Cable	m	5
Weight according to EPTA	kg	3,6
<b>Part number</b>		<b>7 820 85 00 26 0</b>
<b>EAN</b>		<b>4014586864402</b>
<b>Price in € [PC09]</b>		<b>966,00</b>

### FEIN benefits:

- ▶ Metal motor and gearbox housing for maximum load capacity in industrial continuous use.
- ▶ Powerful ventilation for effective motor cooling.
- ▶ Low-wear and low-maintenance.
- ▶ Maximum reliability and outstanding service life.
- ▶ High effective output.
- ▶ Great speed consistency.

### Price includes:

1 wheel guard, 1 pair of flanges, 1 set of keys, 1 anti-vibration handle

You will find other frequencies and voltages in the numerical section.

## HFw 9-125 300 Hz 200 V



For accessories, see page 118

Handy HF compact angle grinder for light-duty grinding and deburring work.

Input	W	900
Output	W	690
Frequency	Hz	300
Voltage/type of current	V/3~	200
Speed, no load	1/min	7 100
Grinding disc Ø	mm	125
Elast. Backing pad Ø	mm	125
Cable	m	5
Weight according to EPTA	kg	2,5
<b>Part number</b>		<b>7 820 86 60 00 0</b>
<b>EAN</b>		<b>4014586869513</b>
<b>Price in € [PC09]</b>		<b>765,45</b>

### FEIN benefits:

- ▶ Highly efficient compact angle grinder with the highest grinding capacity on the market.
- ▶ Dust-proof, fully encapsulated switch for maximum service life.
- ▶ Very thick-walled metal gearbox head made from cast aluminium for maximum stability and service life.
- ▶ Perfect ergonomics with 2 handle zones and the smallest handle size for optimum handling even in continuous use.
- ▶ Powerful ventilation.
- ▶ Air escapes to the bottom.
- ▶ High effective output.
- ▶ Great speed consistency.
- ▶ Low weight.

### Price includes:

1 wheel guard, 1 pair of flanges, 1 anti-vibration handle, 1 set of keys

You will find other frequencies and voltages in the numerical section.

## MSfov 852-1-180 300 Hz 200 V



For accessories, see page 118

Long-neck HF angle grinder for hard-to-reach places.

Input	W	1 900
Output	W	1 400
Frequency	Hz	300
Voltage/type of current	V/3~	200
Speed, no load	1/min	7 450
Grinding disc Ø	mm	180
Flange		M 14
Cable	m	5
Weight according to EPTA	kg	5,3
<b>Part number</b>		<b>7 820 87 60 00 0</b>
<b>EAN</b>		<b>4014586886022</b>
<b>Price in € [PC09]</b>		<b>1.569,75</b>

### FEIN benefits:

- ▶ Low profile gearbox head 65 mm in height, including grinding disc.
- ▶ Metal motor and gearbox housing for maximum load capacity in industrial continuous use.
- ▶ Fully encapsulated motor, 100% dust protection with surface cooling for maximum stability and service life even under extreme conditions of use.
- ▶ Low-wear and low-maintenance.
- ▶ Maximum reliability and outstanding service life.
- ▶ High effective output.
- ▶ Great speed consistency.

### Price includes:

1 wheel guard, 1 pair of flanges, 1 set of keys

You will find other frequencies and voltages in the numerical section.



Grinding

	MSho 840-2 300 Hz 200 V	MSh 843-1 300 Hz 200 V	MSho 849-1 Z 300 Hz 200 V	MShyo 869-1a 300 Hz 200 V	MShyo 869-1d 300 Hz 200 V	MShyo 852-3a 300 Hz 200 V	MShyo 852-4a 300 Hz 200 V	MSho 852-1 300 Hz 200 V	
	Handy HF straight grinder for light-duty grinding work.	Lightweight and handy HF straight grinder for milling work.	Powerful HF straight grinder for medium-duty grinding work with pin tools.	The most powerful FEIN HF straight grinder for satin-finishing work with large tools.	The most powerful FEIN HF straight grinder for heavy-duty grinding work.	Powerful HF straight grinder for medium-to heavy-duty grinding work.	Powerful HF straight grinder for satin-finishing work.	Powerful HF straight grinder for medium-duty to heavy-duty high-speed grinding work.	
Page	112	112	112	113	113	113	114	114	
Application	roughing-down	▲▲	▲▲		▲▲	▲▲		▲▲	
	Deburring							▲	
	satin-finishing				▲▲		▲▲	▲	
Technical features	cutting	▲	▲▲						
	Frequency	300 Hz	300 Hz	300 Hz	300 Hz	300 Hz	300 Hz	300 Hz	
	Voltage/type of current	200 V/3~	200 V/3~	200 V/3~	200 V/3~	200 V/3~	200 V/3~	200 V/3~	
	Input	410 W	1 100 W	1 500 W	3 100 W	3 100 W	1 900 W	1 900 W	1 900 W
	Output	290 W	700 W	1 075 W	2 450 W	2 410 W	1 400 W	1 400 W	1 400 W
	Speed, no load	18 000 1/min	18 000 1/min	18 000 1/min	5 000 1/min	10 200 1/min	10 200 1/min	5 800 1/min	18 000 1/min
	Cable	5 m	5 m	5 m	5 m	5 m	5 m	5 m	5 m
	Weight according to EPTA	2,1 kg	3 kg	3,9 kg	8,9 kg	8,9 kg	5,2 kg	5,7 kg	5,2 kg
	Flange				M 16	M 16	M 12	M 12	M 12
	Collet for max. Ø	6 mm	6 mm	8 mm					
Grinding wheel for max. Ø	50 mm	40 mm	50 mm						

▲ suitability    ▲▲ optimal suitability

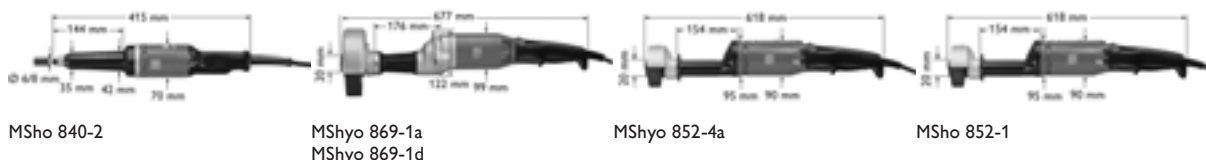

## MSho 840-2 300 Hz 200 V



For accessories, see page 118

Handy HF straight grinder for light-duty grinding work.

Input	W	410
Output	W	290
Frequency	Hz	300
Voltage/type of current	V/3~	200
Speed, no load	1/min	18 000
Grinding wheel for max. Ø	mm	50
Collet for max. Ø	mm	6
Cable	m	5
Weight according to EPTA	kg	2,1
<b>Part number</b>	<b>7 823 03 00 26 0</b>	
<b>EAN</b>	<b>4014586827636</b>	
<b>Price in € [PC09]</b>	<b>767,55</b>	

### FEIN benefits:

- ▶ Extremely handy for universal use.
- ▶ Split grinding spindle with multiple mountings for absolutely precise and vibration-free concentricity.
- ▶ Metal motor and gearbox housing for maximum load capacity in industrial continuous use.
- ▶ Fully encapsulated motor, 100% dust protection with surface cooling for maximum stability and service life even under extreme conditions of use.
- ▶ Low-wear and low-maintenance.
- ▶ Maximum reliability and outstanding service life.
- ▶ High effective output.
- ▶ Great speed consistency.

### Price includes:

1 collet Ø 6 mm, 1 set of keys

You will find other frequencies and voltages in the numerical section.

## MSh 843-1 300 Hz 200 V



For accessories, see page 118

Lightweight and handy HF straight grinder for milling work.

Input	W	1 100
Output	W	700
Frequency	Hz	300
Voltage/type of current	V/3~	200
Speed, no load	1/min	18 000
Grinding wheel for max. Ø	mm	40
Collet for max. Ø	mm	6
Cable	m	5
Weight according to EPTA	kg	3
<b>Part number</b>	<b>7 823 19 00 26 0</b>	
<b>EAN</b>	<b>4014586857947</b>	
<b>Price in € [PC09]</b>	<b>918,75</b>	

### FEIN benefits:

- ▶ Split grinding spindle with multiple mountings for absolutely precise and vibration-free concentricity.
- ▶ Metal motor and gearbox housing for maximum load capacity in industrial continuous use.
- ▶ Powerful ventilation for effective motor cooling.
- ▶ Low-wear and low-maintenance.
- ▶ Maximum reliability and outstanding service life.
- ▶ High effective output.
- ▶ Great speed consistency.

### Price includes:

1 collet Ø 6 mm, 1 set of keys

You will find other frequencies and voltages in the numerical section.

## MSho 849-1 Z 300 Hz 200 V



For accessories, see page 118

Powerful HF straight grinder for medium-duty grinding work with pin tools.

Input	W	1 500
Output	W	1 075
Frequency	Hz	300
Voltage/type of current	V/3~	200
Speed, no load	1/min	18 000
Grinding wheel for max. Ø	mm	50
Collet for max. Ø	mm	8
Cable	m	5
Weight according to EPTA	kg	3,9
<b>Part number</b>	<b>7 823 20 00 26 0</b>	
<b>EAN</b>	<b>4014586858012</b>	
<b>Price in € [PC09]</b>	<b>1.055,25</b>	

### FEIN benefits:

- ▶ Powerful for high grinding capacity.
- ▶ Split grinding spindle with multiple mountings for absolutely precise and vibration-free concentricity.
- ▶ Metal motor and gearbox housing for maximum load capacity in industrial continuous use.
- ▶ Powerful ventilation for effective motor cooling.
- ▶ Low-wear and low-maintenance.
- ▶ Maximum reliability and outstanding service life.
- ▶ High effective output.
- ▶ Great speed consistency.

### Price includes:

1 collet Ø 8 mm, 1 set of keys

You will find other frequencies and voltages in the numerical section.





**MSHyo 869-1a 300 Hz 200 V**

The most powerful FEIN HF straight grinder for satin-finishing work with large tools.



For accessories, see page 118

Input	W	3 100
Output	W	2 450
Frequency	Hz	300
Voltage/type of current	V/3~	200
Speed, no load	1/min	5 000
Flange		M 16
Grinding wheel for max. Ø x width	mm	175 x 40
Cable	m	5
Weight according to EPTA	kg	8,9
<b>Part number</b>		<b>7 824 37 00 26 0</b>
<b>EAN</b>		<b>4014586857633</b>
<b>Price in € [PC09]</b>		<b>1.564,50</b>

**FEIN benefits:**

- ▶ Ideal power/weight ratio and excellent efficiency.
- ▶ Powerful for high grinding capacity.
- ▶ Extremely quiet running.
- ▶ Metal motor and gearbox housing for maximum load capacity in industrial continuous use.
- ▶ Fully encapsulated motor, 100% dust protection with surface cooling for maximum stability and service life even under extreme conditions of use.
- ▶ Low-wear and low-maintenance.
- ▶ Maximum reliability and outstanding service life.
- ▶ High effective output.
- ▶ Great speed consistency.

**Price includes:**

1 wheel guard, 1 set of keys, 1 pair of flanges

You will find other frequencies and voltages in the numerical section.

**MSHyo 869-1d 300 Hz 200 V**

The most powerful FEIN HF straight grinder for heavy-duty grinding work.



For accessories, see page 118

Input	W	3 100
Output	W	2 410
Frequency	Hz	300
Voltage/type of current	V/3~	200
Speed, no load	1/min	10 200
Flange		M 16
Grinding wheel for max. Ø x width	mm	150 x 32
Cable	m	5
Weight according to EPTA	kg	8,9
<b>Part number</b>		<b>7 824 38 00 26 0</b>
<b>EAN</b>		<b>4014586858111</b>
<b>Price in € [PC09]</b>		<b>1.564,50</b>

**FEIN benefits:**

- ▶ Ideal power/weight ratio and excellent efficiency.
- ▶ Powerful for high grinding capacity.
- ▶ Extremely quiet running.
- ▶ Metal motor and gearbox housing for maximum load capacity in industrial continuous use.
- ▶ Fully encapsulated motor, 100% dust protection with surface cooling for maximum stability and service life even under extreme conditions of use.
- ▶ Low-wear and low-maintenance.
- ▶ Maximum reliability and outstanding service life.
- ▶ High effective output.
- ▶ Great speed consistency.

**Price includes:**

1 wheel guard, 1 set of keys, 1 pair of flanges

You will find other frequencies and voltages in the numerical section.

**MSHyo 852-3a 300 Hz 200 V**

Powerful HF straight grinder for medium- to heavy-duty grinding work.



For accessories, see page 118

Input	W	1 900
Output	W	1 400
Frequency	Hz	300
Voltage/type of current	V/3~	200
Speed, no load	1/min	10 200
Flange		M 12
Grinding wheel for max. Ø x width	mm	125 x 32/28
Cable	m	5
Weight according to EPTA	kg	5,2
<b>Part number</b>		<b>7 824 39 00 26 0</b>
<b>EAN</b>		<b>4014586857657</b>
<b>Price in € [PC09]</b>		<b>1.092,00</b>

**FEIN benefits:**

- ▶ Powerful for high grinding capacity.
- ▶ Extremely quiet running.
- ▶ Metal motor and gearbox housing for maximum load capacity in industrial continuous use.
- ▶ Fully encapsulated motor, 100% dust protection with surface cooling for maximum stability and service life even under extreme conditions of use.
- ▶ Low-wear and low-maintenance.
- ▶ Maximum reliability and outstanding service life.
- ▶ High effective output.
- ▶ Great speed consistency.

**Price includes:**

1 wheel guard, 1 set of keys, 1 pair of flanges

You will find other frequencies and voltages in the numerical section.

## MShyo 852-4a 300 Hz 200 V



For accessories, see page 118

Powerful HF straight grinder for satin-finishing work.

Input	W	1 900
Output	W	1 400
Frequency	Hz	300
Voltage/type of current	V/3~	200
Speed, no load	1/min	5 800
Flange		M 12
Grinding wheel for max. Ø x width	mm	125 x 32/28
Cable	m	5
Weight according to EPTA	kg	5,7
<b>Part number</b>		<b>7 824 40 00 26 0</b>
<b>EAN</b>		<b>4014586858180</b>
<b>Price in € [PC09]</b>		<b>1.307,25</b>

### FEIN benefits:

- ▶ Powerful for high grinding capacity.
- ▶ Metal motor and gearbox housing for maximum load capacity in industrial continuous use.
- ▶ Extremely quiet running.
- ▶ High effective output.
- ▶ Fully encapsulated motor, 100% dust protection with surface cooling for maximum stability and service life even under extreme conditions of use.
- ▶ Maximum reliability and outstanding service life.
- ▶ Low-wear and low-maintenance.
- ▶ Great speed consistency.

### Price includes:

1 wheel guard, 1 pair of flanges, 1 set of keys

You will find other frequencies and voltages in the numerical section.

## MSho 852-1 300 Hz 200 V



For accessories, see page 118

Powerful HF straight grinder for medium-duty to heavy-duty high-speed grinding work.

Input	W	1 900
Output	W	1 400
Frequency	Hz	300
Voltage/type of current	V/3~	200
Speed, no load	1/min	18 000
Flange		M 12
Grinding wheel for max. Ø x width	mm	85 x 32/26
Cable	m	5
Weight according to EPTA	kg	5,2
<b>Part number</b>		<b>7 824 42 00 26 0</b>
<b>EAN</b>		<b>4014586858241</b>
<b>Price in € [PC09]</b>		<b>1.048,95</b>

### FEIN benefits:

- ▶ Ideal power/weight ratio and excellent efficiency.
- ▶ Extremely quiet running.
- ▶ Metal motor and gearbox housing for maximum load capacity in industrial continuous use.
- ▶ Fully encapsulated motor, 100% dust protection with surface cooling for maximum stability and service life even under extreme conditions of use.
- ▶ Low-wear and low-maintenance.
- ▶ Maximum reliability and outstanding service life.
- ▶ High effective output.
- ▶ Great speed consistency.

### Price includes:

1 set of keys, 1 pair of flanges, 1 wheel guard

You will find other frequencies and voltages in the numerical section.

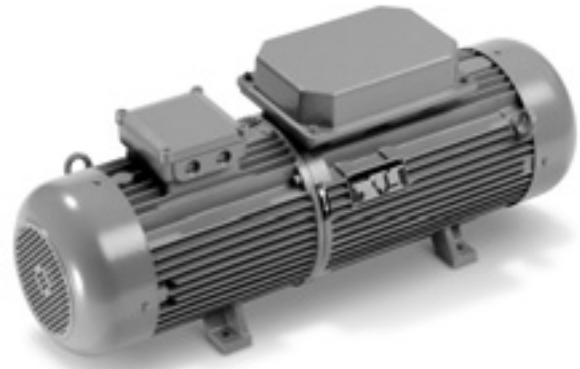

Grinding

	MO83-7,5 KSR 50400 300 Hz 200 V	MO83-11 KSR 50400 300 Hz 200 V	MO83-15 KSR 50400 300 Hz 200 V	MO83-20 KSR 50400 300 Hz 200 V	MO83-25 KSR 50400 300 Hz 200 V	MO83-30 KSR 50400 300 Hz 200 V	MO83-45 KSR 50400 300 Hz 200 V
<b>Page</b>	116	116	116	116	117	117	117
<b>Technical features</b>	Primary voltage	200 V	200 V	200 V	200 V	200 V	200 V
	Output power	7,5 W	11 W	15 W	20 W	25 W	30 W
	Motor power	8 W	11,6 W	15 W	20 W	24 W	28 W
	Motor current (400 V)	16 A	21,4 A	26,6 A	34,2 A	44,2 A	49,4 A
	Power consumption	11,1 W	14,9 W	18,5 W	23,8 W	30,7 W	34,4 W
	Idling power	1,1 W	1,4 W	2,4 W	2,8 W	3,3 W	3,7 W
	Weight	75 kg	110 kg	164 kg	176 kg	200 kg	240 kg

**MO83-7,5KSR 50400 300 Hz 200 V**



For accessories, see page 118

Primary voltage	V	200
Output power	W	7,5
Motor power	W	8
Motor current (400 V)	A	16
Power consumption	W	11,1
Idling power	W	1,1
Length x height	mm	794 x 360 mm
Weight	kg	75
<b>Part number</b>		<b>9 28 19 340 26 4</b>
<b>EAN</b>		<b>4014586845494</b>
<b>Price in € [PC10]</b>		<b>7.516,95</b>

You will find other frequencies and voltages in the numerical section.

**MO83-11KSR 50400 300 Hz 200 V**



For accessories, see page 118

Primary voltage	V	200
Output power	W	11
Motor power	W	11,6
Motor current (400 V)	A	21,4
Power consumption	W	14,9
Idling power	W	1,4
Length x height	mm	844 x 360 mm
Weight	kg	110
<b>Part number</b>		<b>9 28 21 340 26 0</b>
<b>EAN</b>		<b>4014586845593</b>
<b>Price in € [PC10]</b>		<b>8.070,30</b>

You will find other frequencies and voltages in the numerical section.

**MO83-15KSR 50400 300 Hz 200 V**



For accessories, see page 118

Primary voltage	V	200
Output power	W	15
Motor power	W	15
Motor current (400 V)	A	26,6
Power consumption	W	18,5
Idling power	W	2,4
Length x height	mm	1 058 x 416 mm
Weight	kg	164
<b>Part number</b>		<b>9 28 22 340 26 4</b>
<b>EAN</b>		<b>4014586845661</b>
<b>Price in € [PC10]</b>		<b>9.770,25</b>

You will find other frequencies and voltages in the numerical section.

**MO83-20KSR 50400 300 Hz 200 V**



For accessories, see page 118

Primary voltage	V	200
Output power	W	20
Motor power	W	20
Motor current (400 V)	A	34,2
Power consumption	W	23,8
Idling power	W	2,8
Length x height	mm	1 058 x 416 mm
Weight	kg	176
<b>Part number</b>		<b>9 28 28 340 26 6</b>
<b>EAN</b>		<b>4014586845791</b>
<b>Price in € [PC10]</b>		<b>11.179,35</b>

You will find other frequencies and voltages in the numerical section.



**MO83-25KSR 50400 300 Hz 200 V**



For accessories, see page 118

Primary voltage	V	200
Output power	W	25
Motor power	W	24
Motor current (400 V)	A	44,2
Power consumption	W	30,7
Idling power	W	3,3
Length x height	mm	1 058 x 416 mm
Weight	kg	200
<b>Part number</b>	<b>9 28 29 340 26 7</b>	
<b>EAN</b>	<b>4014586845852</b>	
<b>Price in € [PC10]</b>	<b>12.926,55</b>	

You will find other frequencies and voltages in the numerical section.

**MO83-30KSR 50400 300 Hz 200 V**



For accessories, see page 118

Primary voltage	V	200
Output power	W	30
Motor power	W	28
Motor current (400 V)	A	49,4
Power consumption	W	34,4
Idling power	W	3,7
Length x height	mm	1 058 x 416 mm
Weight	kg	240
<b>Part number</b>	<b>9 28 24 340 26 2</b>	
<b>EAN</b>	<b>4014586845715</b>	
<b>Price in € [PC10]</b>	<b>15.244,95</b>	

You will find other frequencies and voltages in the numerical section.

**MO83-45KSR 50400 300 Hz 200 V**



For accessories, see page 118

Primary voltage	V	200
Output power	W	45
Motor power	W	41
Motor current (400 V)	A	75,1
Power consumption	W	52,1
Idling power	W	5,4
Length x height	mm	1 252 x 463 mm
Weight	kg	360
<b>Part number</b>	<b>9 28 26 340 26 8</b>	
<b>EAN</b>	<b>4014586845746</b>	
<b>Price in € [PC10]</b>	<b>18.212,25</b>	

You will find other frequencies and voltages in the numerical section.

**General accessories for HF tools**



**anti-vibration handle**  
M 8, vibration absorbing, to reduce the vibrations during longer jobs.

Part number	Price in €
3 21 19 124 01 0	8,48



**anti-vibration handle**  
M 10, vibration absorbing, to reduce the vibrations during longer jobs.

Part number	Price in €
3 21 19 118 01 3	34,09



**anti-vibration handle**  
M 14, vibration absorbing, to reduce the vibrations during longer jobs.

Part number	Price in €
3 21 19 117 01 5	34,09



**Male connector**  
over 50 V, 16 A, 100 - 300 Hz, 10 h, 3 P+E

Part number	Price in €
3 07 28 123 00 7	22,71



**Male connector**  
over 50 V, 32 A, 100 - 300 Hz, 10 h, 3 P+E

Part number	Price in €
3 07 28 124 00 5	30,88



**Sleeve plug**  
over 50 V, 16 A, 100 - 300 Hz, 10 h, 3 P+E

Part number	Price in €
3 07 28 130 00 0	27,95



**Sleeve plug**  
over 50 V, 32 A, 100 - 300 Hz, 10 h, 3 P+E

Part number	Price in €
3 07 28 131 00 9	36,10



**Motor protection plug**  
FEIN's motor safety plugs provide reliable overload protection for high-frequency power tools. A bimetallic actuator, which is individually set to the corresponding rated current of the connected high-frequency tool, prevents premature or late activation in the event of brief overloading. The motor safety plug is fitted on the high-frequency power tool's connector cable instead of the normal male connector. The motor safety plug consists of a CEE plug, thermal actuators with temperature compensation and a rotary activation toggle. suited to the 840 series, setting range 1.6 - 2.5 A

Model	Part number	Price in €
16 A	3 07 56 085 00 2	175,08
32 A	3 07 56 093 00 9	182,31



**Motor protection plug**  
FEIN's motor safety plugs provide reliable overload protection for high-frequency power tools. A bimetallic actuator, which is individually set to the corresponding rated current of the connected high-frequency tool, prevents premature or late activation in the event of brief overloading. The motor safety plug is fitted on the high-frequency power tool's connector cable instead of the normal male connector. The motor safety plug consists of a CEE plug, thermal actuators with temperature compensation and a rotary activation toggle. suited to the HF 9, 843, 849 series, setting range 4 - 6.3 A

Model	Part number	Price in €
16 A	3 07 56 087 00 9	175,08
32 A	3 07 56 095 00 1	182,31



**Motor protection plug**  
FEIN's motor safety plugs provide reliable overload protection for high-frequency power tools. A bimetallic actuator, which is individually set to the corresponding rated current of the connected high-frequency tool, prevents premature or late activation in the event of brief overloading. The motor safety plug is fitted on the high-frequency power tool's connector cable instead of the normal male connector. The motor safety plug consists of a CEE plug, thermal actuators with temperature compensation and a rotary activation toggle. suited to the 852 series, setting range 6.3 - 9 A

Model	Part number	Price in €
16 A	3 07 56 088 00 7	196,76
32 A	3 07 56 096 00 4	205,44



**Motor protection plug**  
FEIN's motor safety plugs provide reliable overload protection for high-frequency power tools. A bimetallic actuator, which is individually set to the corresponding rated current of the connected high-frequency tool, prevents premature or late activation in the event of brief overloading. The motor safety plug is fitted on the high-frequency power tool's connector cable instead of the normal male connector. The motor safety plug consists of a CEE plug, thermal actuators with temperature compensation and a rotary activation toggle. suited to the 869 series, setting range 9 - 12.5 A

Model	Part number	Price in €
16 A	3 07 56 089 00 1	196,76
32 A	3 07 56 097 00 8	205,44



**Motor protection plug**  
FEIN's motor safety plugs provide reliable overload protection for high-frequency power tools. A bimetallic actuator, which is individually set to the corresponding rated current of the connected high-frequency tool, prevents premature or late activation in the event of brief overloading. The motor safety plug is fitted on the high-frequency power tool's connector cable instead of the normal male connector. The motor safety plug consists of a CEE plug, thermal actuators with temperature compensation and a rotary activation toggle. suited to the 870 series, setting range 12.5 - 16 A

Model	Part number	Price in €
16 A	3 07 56 090 00 3	196,76
32 A	3 07 56 098 00 6	205,44

**General accessories for frequency converters**



**Assembly socket**  
over 50 V, 16 A, 100 - 300 Hz, 10 h, 3 P+E

Part number	Price in €
3 07 28 141 00 8	44,26



**Wall socket**  
over 50 V, 16 A, 100 - 300 Hz, 10 h, 3 P+E

Part number	Price in €
3 07 28 138 00 5	31,45

**Wall socket**  
over 50 V, 32 A, 100 - 300 Hz, 10 h, 3 P+E

Part number	Price in €
3 07 28 138 00 3	41,93



**Device combination**



**Device combination**  
for MO 83 - 7.5 KSR

Part number	Price in €
3 07 49 065 00 9	1.530,90



**Device combination**  
for MO 83 - 11 KSR

Part number	Price in €
3 07 49 073 00 6	1.980,30



**Device combination**  
for MO 83 - 15 KSR

Part number	Price in €
3 07 49 067 00 6	2.212,35

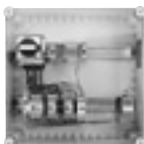

**Device combination**  
for MO 83 - 20 KSR

Part number	Price in €
3 07 49 068 00 4	2.620,80



**Device combination**  
for MO 83 - 25 KSR / MO 83 - 30 KSR

Part number	Price in €
3 07 49 069 00 8	2.736,30



**Device combination**  
for MO 83 - 45 KSR

Part number	Price in €
3 07 49 070 00 0	3.435,60

**Accessories for MO 83 - 25 KSR, MO 83 - 30 KSR,  
MO 83 - 45 KSR**

**Anti vibration mounts**

4 items required for each frequency converter.

Part number	Price in €
3 14 15 020 00 8	35,64

**Accessories for MO 83 - 20 KSR, MO 83 - 7.5 KSR,  
MO 83 - 11 KSR, MO 83 - 15 KSR**

**Anti vibration mounts**

4 items required for each frequency converter.

Part number	Price in €
3 14 15 081 00 1	15,50

Grinding





## There are many different kinds of metal and our tools can tell the difference.

Corrugated and trapezoid sheet metals, steel plates and profiles all have special requirements. FEIN knows that it's all in the sheet metal working - and that's been the case since 1927. From this long-standing experience, a range of products has been born, which is unsurpassed in its diversity and professionalism. Compact nibblers, the most versatile of tools has unrivalled curve-cutting precision. Metal shears that combine speed, robustness and reliability. Lastly, throatless shears, which are ideal for cutting where swarf loss is to be avoided. No matter what their speciality, all the FEIN metalworking tools have one thing in common: They are perfectly designed for all tasks to be undertaken during the working day.



---

### Slitting shears Page 122

Clean, distortion-free cutting of sheet metals, profiles and pipes - with just one continuous cut.



---

### Sheet metal shears Page 125

The right choice for everyone who values the highest cutting performance in sheet metal and stainless steel.



---

### Nibblers Page 128

Extremely versatile and curve-compatible, particularly suited for trapezoid sheet metals, corrugated sheet metals, profiles and curved single rolled sheets.



		BSS 1.6 E	BSS 1.6 CE	BSS 2.0 E
		Easy-to-use and curve-compatible slitting shears for distortion-free cutting.	Easy-to-use and curve-compatible slitting shears with integrated chip clipper.	Powerful slitting shears for stainless steel processing, spiral seam pipes and profiles.
<b>Page</b>		123	123	123
<b>Application</b>	Cuts	▲▲	▲▲	▲▲
	Curve cuts	▲	▲	
	Cut-outs	▲▲	▲▲	
<b>Equipment</b>	FEIN high-power motor	●	●	
	Chip clipper	●	●	
<b>Technical features</b>	Input	350 W	350 W	350 W
	Strokes	2 100 - 4 500 1/min	2 100 - 4 500 1/min	1 300 - 2 600 1/min
	Cutting speed	6 - 10 m/min	6 - 10 m/min	2 - 4 m/min
	Weight according to EPTA	1,5 kg	1,5 kg	1,7 kg
	Steel up to 400 N/mm <sup>2</sup>	1,6 mm	1,6 mm	2 mm
	Steel up to 600 N/mm <sup>2</sup>	1,2 mm	1,2 mm	1,5 mm
	Steel up to 800 N/mm <sup>2</sup>	1 mm	1 mm	1,3 mm
	Non-ferrous metals up to 250 N/mm <sup>2</sup>	2 mm	2 mm	3 mm
	Cutting width	5 mm	5 mm	5 mm
	Rad. of smallest curve	90 (30) mm	90 (30) mm	245 mm
Immersion Ø	15 (8) mm	15 (8) mm	12 mm	

▲ suitability    ▲▲ optimal suitability    ● included

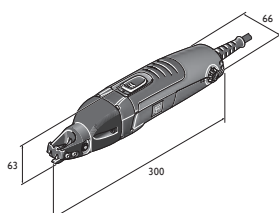

BSS 1.6 E

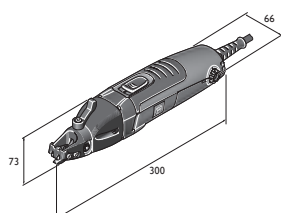

BSS 1.6 CE

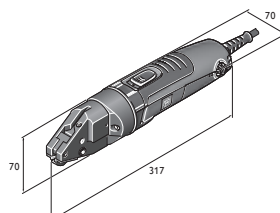

BSS 2.0 E

**BSS 1.6 E**

Easy-to-use and curve-compatible slitting shears for distortion-free cutting.



For accessories, see page 124  
For cordless variant of tool,  
see page 48

Input	W	350
Output	W	210
Strokes	1/min	2 100 - 4 500
Cutting speed	m/min	6 - 10
Steel up to 400 N/mm <sup>2</sup>	mm	1,6
Steel up to 600 N/mm <sup>2</sup>	mm	1,2
Steel up to 800 N/mm <sup>2</sup>	mm	1
Non-ferrous metals up to 250 N/mm <sup>2</sup>	mm	2
Cutting width	mm	5
Rad. of smallest curve	mm	90 (30) <sup>1</sup>
Immersion Ø	mm	15 (8) <sup>1</sup>
Cable with plug	m	5
Weight according to EPTA	kg	1,5
<b>Part number</b>		<b>7 230 31 61 00 0</b>
<b>EAN</b>		<b>4014586874661</b>
<b>Price in € [PC01]</b>		<b>550,20</b>

**FEIN benefits:**

- ▶ Rapid work progress due to excellent view of the cutting line through the open-fronted cutting head.
- ▶ Left and right curve cuts and distortion-free cutting possible with just one continuous chip.
- ▶ QuickIN for rapid toolfree blade changing, with no further adjustment required.
- ▶ Excellent ergonomics and low weight.
- ▶ Motor with outstanding performance and stability.
- ▶ Cutting blade with excellent tool life.
- ▶ 5 metre cable.
- ▶ Clean swarf removal prevents injuries or scratches on workpieces.
- ▶ Stainless steel up to 1.2 mm.
- ▶ Wide range of accessories.
- ▶ <sup>1</sup> with blade for curves

**Price includes:**

1 Knife, straight, up to 1.6 mm, 1 pair of cutting bars, 1 key

**BSS 1.6 CE**

Easy-to-use and curve-compatible slitting shears with integrated chip clipper.



For accessories, see page 124

Input	W	350
Output	W	210
Strokes	1/min	2 100 - 4 500
Cutting speed	m/min	6 - 10
Steel up to 400 N/mm <sup>2</sup>	mm	1,6
Steel up to 600 N/mm <sup>2</sup>	mm	1,2
Steel up to 800 N/mm <sup>2</sup>	mm	1
Non-ferrous metals up to 250 N/mm <sup>2</sup>	mm	2
Cutting width	mm	5
Rad. of smallest curve	mm	90 (30) <sup>1</sup>
Immersion Ø	mm	15 (8) <sup>1</sup>
Cable with plug	m	5
Weight according to EPTA	kg	1,5
<b>Part number</b>		<b>7 230 32 61 00 0</b>
<b>EAN</b>		<b>4014586874739</b>
<b>Price in € [PC01]</b>		<b>612,15</b>

**FEIN benefits:**

- ▶ Chip clipper for clipping off the cut chip at any point.
- ▶ Left and right curve cuts and distortion-free cutting possible with just one continuous chip.
- ▶ Rapid work progress due to excellent view of the cutting line through the open-fronted cutting head.
- ▶ Excellent ergonomics and low weight.
- ▶ Motor with outstanding performance and stability.
- ▶ Cutting blade with excellent tool life.
- ▶ 5 metre cable.
- ▶ Clean swarf removal prevents injuries or scratches on workpieces.
- ▶ Stainless steel up to 1.2 mm.
- ▶ Wide range of accessories.
- ▶ <sup>1</sup> with blade for curves

**Price includes:**

1 Knife, straight, up to 1.6 mm, 1 pair of cutting bars, 1 key

**BSS 2.0 E**

Powerful slitting shears for stainless steel processing, spiral seam pipes and profiles.



For accessories, see page 124

Input	W	350
Output	W	210
Strokes	1/min	1 300 - 2 600
Cutting speed	m/min	2 - 4
Steel up to 400 N/mm <sup>2</sup>	mm	2
Steel up to 600 N/mm <sup>2</sup>	mm	1,5
Steel up to 800 N/mm <sup>2</sup>	mm	1,3
Non-ferrous metals up to 250 N/mm <sup>2</sup>	mm	3
Cutting width	mm	5
Rad. of smallest curve	mm	245
Immersion Ø	mm	12
Cable with plug	m	5
Weight according to EPTA	kg	1,7
<b>Part number</b>		<b>7 230 33 61 00 0</b>
<b>EAN</b>		<b>4014586874807</b>
<b>Price in € [PC01]</b>		<b>758,10</b>

**FEIN benefits:**

- ▶ High-strength blades make it ideal for reinforcement profiles in drywall construction and cutting stainless steel.
- ▶ Robust cutting head for stationary application. Machine can be very easily clamped in a vice.
- ▶ Left and right curve cuts and distortion-free cutting possible with just one continuous chip.
- ▶ High performance and powerful motor when it comes to the most difficult tasks. Suitable for folded spiral-seam pipes with 4 x 0.75 mm connecting folds
- ▶ Ideal for trimming profiled sections.
- ▶ Best suited for trimming and cutting.
- ▶ Motor with outstanding performance and stability.
- ▶ Cutting blade with excellent tool life.
- ▶ 5 metre cable.
- ▶ Clean swarf removal prevents injuries or scratches on workpieces.
- ▶ Stainless steel up to 1.5 mm.
- ▶ Wide range of accessories.

**Price includes:**

1 cutter blade, 1 pair of cutting bars

**General accessories**



**Tool case**  
Plastic, inner dimensions: 470 x 275 x 116 mm

Part number	Price in €
3 39 01 118 01 0	37,26



**Plastic box**  
Box insert with lockable lid for small parts and accessories, suitable for tool box 3 39 01 118 01 0, max 5 items/box.

Part number	Price in €
3 39 01 119 00 0	3,97



**Cutting paste**  
Lubricating agents for working on sheet metals.

Part number	Price in €
3 21 32 020 12 9	14,11

**Accessories for BSS 1.6 E, BSS 1.6 CE**

**Cutting blade**  
for steel sheet up to 400 N/mm<sup>2</sup>

Plate thickness mm	Part number	Price in €
1,6	3 13 08 150 00 9	65,26

**Cutting blade**  
for stainless steel up to 800 N/mm<sup>2</sup>

Plate thickness mm	Part number	Price in €
0,8	3 13 08 152 00 1	78,47

**Blade for curves**  
for steel sheet up to 400 N/mm<sup>2</sup>

Plate thickness mm	Part number	Price in €
1	3 13 08 151 00 8	69,35

**Accessories for BSS 1.6 CE**

**Cutting bars**  
1 pair

Part number	Price in €
3 13 08 153 02 0	70,25

**Accessories for BSS 1.6 E**

**Cutting bars**  
1 pair

Part number	Price in €
3 13 08 153 01 4	70,25

**Accessories for BSS 2.0 E**



**Cutting blade**  
for steel sheet up to 400 N/mm<sup>2</sup>

Plate thickness mm	Part number	Price in €
2	3 13 08 110 00 3	90,73

**Cutting blade**  
for stainless steel up to 800 N/mm<sup>2</sup>

Plate thickness mm	Part number	Price in €
1,3	3 13 08 123 00 8	142,58



**Cutting bars**  
Pack of 2

Part number	Price in €
3 13 08 113 00 9	96,73

**Blade pin**

Part number	Price in €
3 13 08 111 00 2	14,43



	BLS 1.6 E	BLS 2.5 E	BLS 3.5	BLS 4.2	
	Easy-to-use, curve-compatible sheet metal shears for cutting and trimming thin sheets.	Easy-to-use, curve-compatible sheet metal shears for working with stainless steel.	Universal sheet metal shears with tool-free setting of material thickness.	Powerful sheet metal shears for cutting, separating and trimming sheet metal constructions.	
<b>Page</b>	126	126	126	127	
<b>Application</b>	Cuts	▲▲	▲▲	▲▲	▲▲
	Curve cuts	▲	▲	▲	▲
<b>Equipment</b>	FEIN high-power motor	●	●	●	●
	Reversing blade	4x	4x	2x	2x
	Chip suppressor			●	●
<b>Technical features</b>	Input	350 W	350 W	1 200 W	1 200 W
	Strokes	2 300 - 4 800 1/min	800 - 1 700 1/min	1 500 1/min	750 1/min
	Cutting speed	8 - 12 m/min	3 - 6 m/min	4 - 5 m/min	4 - 5 m/min
	Weight according to EPTA	1,7 kg	2,1 kg	5,4 kg	5,2 kg
	Steel up to 400 N/mm <sup>2</sup>	1,6 mm	2,5 mm	3,5 mm	4,2 mm
	Steel up to 600 N/mm <sup>2</sup>	1,2 mm	2 mm	3 mm	3 mm
	Steel up to 800 N/mm <sup>2</sup>	1 mm	1,6 mm	2 mm	2 mm
	Non-ferrous metals up to 250 N/mm <sup>2</sup>	2 mm	3 mm	4 mm	5 mm
Rad. of smallest curve	15 mm	20 mm	30 mm	25 mm	

▲ suitability    ▲▲ optimal suitability    ● included

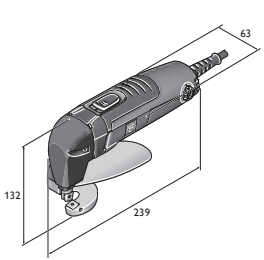

BLS 1.6 E

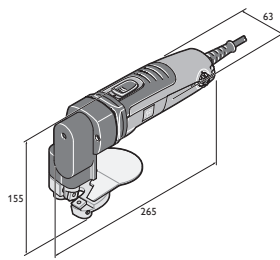

BLS 2.5 E

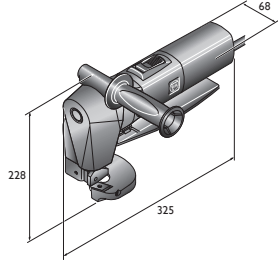

BLS 3.5

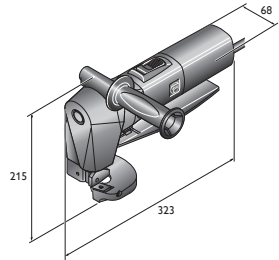

BLS 4.2

Sheet metal working

**BLS 1.6 E**

Easy-to-use, curve-compatible sheet metal shears for cutting and trimming thin sheets.



For accessories, see page 127  
For cordless variant of tool, see page 48

Input	W	350
Output	W	210
Strokes	1/min	2 300 - 4 800
Cutting speed	m/min	8 - 12
Steel up to 400 N/mm <sup>2</sup>	mm	1,6
Steel up to 600 N/mm <sup>2</sup>	mm	1,2
Steel up to 800 N/mm <sup>2</sup>	mm	1
Non-ferrous metals up to 250 N/mm <sup>2</sup>	mm	2
Rad. of smallest curve	mm	15
Cable with plug	m	5
Weight according to EPTA	kg	1,7
<b>Part number</b>	<b>7 230 34 61 00 0</b>	
<b>EAN</b>	<b>4014586874876</b>	
<b>Price in € [PC01]</b>	<b>513,45</b>	

**FEIN benefits:**

- ▶ Outstanding ergonomics through compact and simple construction for optimal mobility of the shears.
- ▶ Good curve precision with low sheet-metal distortion.
- ▶ Four-fold reversing blade for clean and burr-free cutting with low operating costs.
- ▶ Perfect for trimming and cutting.
- ▶ Unrestricted view of the cutting line.
- ▶ Motor with outstanding performance and stability.
- ▶ 5 metre cable.
- ▶ Stainless steel up to 1.0 mm.

**Price includes:**

1 pair of blades, 1 set of wrenches, 1 hand guard

**BLS 2.5 E**

Easy-to-use, curve-compatible sheet metal shears for working with stainless steel.



For accessories, see page 127

Input	W	350
Output	W	210
Strokes	1/min	800 - 1 700
Cutting speed	m/min	3 - 6
Steel up to 400 N/mm <sup>2</sup>	mm	2,5
Steel up to 600 N/mm <sup>2</sup>	mm	2
Steel up to 800 N/mm <sup>2</sup>	mm	1,6
Non-ferrous metals up to 250 N/mm <sup>2</sup>	mm	3
Rad. of smallest curve	mm	20
Cable with plug	m	5
Weight according to EPTA	kg	2,1
<b>Part number</b>	<b>7 230 35 61 00 0</b>	
<b>EAN</b>	<b>4014586874944</b>	
<b>Price in € [PC01]</b>	<b>786,45</b>	

**FEIN benefits:**

- ▶ High performance and powerful motor for the most difficult tasks.
- ▶ Unrestricted view of the cutting line makes faster work progress possible.
- ▶ Four-fold reversing blade for clean and burr-free cutting with low operating costs.
- ▶ Perfect for trimming and cutting.
- ▶ Unrestricted view of the cutting line.
- ▶ Good curve precision with low sheet-metal distortion.
- ▶ 5 metre cable.
- ▶ Stainless steel up to 1.6 mm.

**Price includes:**

1 pair of blades, 1 set of wrenches, 1 hand guard

**BLS 3.5**

Universal sheet metal shears with tool-free setting of material thickness.



For accessories, see page 127

Input	W	1 200
Output	W	750
Strokes	1/min	1 500
Cutting speed	m/min	4 - 5
Steel up to 400 N/mm <sup>2</sup>	mm	3,5
Steel up to 600 N/mm <sup>2</sup>	mm	3
Steel up to 800 N/mm <sup>2</sup>	mm	2
Non-ferrous metals up to 250 N/mm <sup>2</sup>	mm	4
Rad. of smallest curve	mm	30
Cable with plug	m	5
Weight according to EPTA	kg	5,4
<b>Part number</b>	<b>7 230 23 00 23 8</b>	
<b>EAN</b>	<b>4014586848624</b>	
<b>Price in € [PC01]</b>	<b>1.477,35</b>	

**FEIN benefits:**

- ▶ Tool-free height adjustment of the plunger blade for adapting to various material thicknesses.
- ▶ Excellent work progress for rapid completion of large and long surfaces.
- ▶ Patented swarf suppresser for optimum and safe swarf removal.
- ▶ Perfect for the trimming of sheet metal constructions.
- ▶ Excellent power-to-weight ratio.
- ▶ Unrestricted view of the cutting line.
- ▶ Motor with outstanding performance and stability.
- ▶ Two-fold reversing blade.
- ▶ 5 metre cable.
- ▶ Stainless steel up to 2.0 mm.
- ▶ Wide range of accessories.

**Price includes:**

1 pair of blades, 1 hand guard, 1 additional handle, 1 set of wrenches





**BLS 4.2**

Powerful sheet metal shears for cutting, separating and trimming sheet metal constructions.



For accessories, see page 127

Input	W	1 200
Output	W	750
Strokes	1/min	750
Cutting speed	m/min	4 - 5
Steel up to 400 N/mm <sup>2</sup>	mm	4,2
Steel up to 600 N/mm <sup>2</sup>	mm	3
Steel up to 800 N/mm <sup>2</sup>	mm	2
Non-ferrous metals up to 250 N/mm <sup>2</sup>	mm	5
Rad. of smallest curve	mm	25
Cable with plug	m	5
Weight according to EPTA	kg	5,2
<b>Part number</b>	<b>7 230 24 00 23 4</b>	
<b>EAN</b>	<b>4014586848631</b>	
<b>Price in € [PC01]</b>	<b>1.546,65</b>	

**FEIN benefits:**

- ▶ High performance and powerful motor for the most difficult tasks.
- ▶ Excellent work progress for rapid completion of large and long surfaces.
- ▶ Patented swarf suppresser for optimum and safe swarf removal.
- ▶ Perfect for the trimming of sheet metal constructions.
- ▶ Excellent power-to-weight ratio.
- ▶ Unrestricted view of the cutting line.
- ▶ Two-fold reversing blade.
- ▶ 5 metre cable.
- ▶ Stainless steel up to 2.0 mm.
- ▶ Wide range of accessories.

**Price includes:**

- 1 pair of blades, 1 hand guard, 1 additional handle, 1 gauge, 3 wrenches

**Sheet metal shears**

**General accessories**



**Tool case**

Plastic, inner dimensions: 470 x 275 x 116 mm

Part number	Price in €
3 39 01 118 01 0	37,26



**Plastic box**

Box insert with lockable lid for small parts and accessories, suitable for tool box 3 39 01 118 01 0, max 5 items/box.

Part number	Price in €
3 39 01 119 00 0	3,97



**Cutting paste**

Lubricating agents for working on sheet metals.

Part number	Price in €
3 21 32 020 12 9	14,11

**Accessories for BLS 1.6 E**



**Plunger blade and fixed blade**

for steel sheet up to 800 N/mm<sup>2</sup>

Part number	Price in €
3 13 08 072 00 0	26,99

**Accessories for BLS 2.5 E**

**Plunger blade and fixed blade**

for steel sheet up to 800 N/mm<sup>2</sup>

Plate thickness mm	Part number	Price in €
1,6	6 36 01 101 00 9	22,03

**Accessories for BLS 3.5**

**Fixed blade**

for steel sheet up to 400 N/mm<sup>2</sup>

Plate thickness mm	Part number	Price in €
3,5	3 13 08 136 00 2	50,67

**Fixed blade**

for stainless steel up to 800 N/mm<sup>2</sup>

Plate thickness mm	Part number	Price in €
2	3 13 08 143 00 6	58,29

**Plunger blade**

for steel sheet up to 400 N/mm<sup>2</sup>

Plate thickness mm	Part number	Price in €
3,5	3 13 08 146 00 1	51,38

**Plunger blade**

for stainless steel up to 800 N/mm<sup>2</sup>

Plate thickness mm	Part number	Price in €
2	3 13 08 147 00 5	61,32

**Accessories for BLS 4.2**

**Fixed blade**

Part number	Price in €
3 13 08 092 00 8	60,46

**Plunger blade**

for steel sheet up to 400 N/mm<sup>2</sup>

Plate thickness mm	Part number	Price in €
4,2	3 13 08 096 00 7	101,30

**Plunger blade**

for stainless steel up to 800 N/mm<sup>2</sup>

Plate thickness mm	Part number	Price in €
2	3 13 08 098 00 9	157,91



	BLK 1.3 TE	BLK 1.3 CSE	BLK 1.6 E	BLK 1.6 LE	BLK 2.0 E	BLK 3.5	BLK 5.0	
	Compact and rapid nibbler for trapezoid sheet metals.	Compact and rapid nibbler for corrugated sheet metals.	Universal nibbler for sheets, profiles, trapezoid and corrugated sheet metals.	Compact nibbler for deep-channel trapezoidal sheet metals in roof and façade construction.	Compact nibbler with unlimited curve precision for corners and edges.	Powerful nibbler with unlimited curve-compatibility for grooves and cut-outs.	Powerful nibbler for heavy dismantling and cutting applications.	
<b>Page</b>	129	129	129	130	130	131	131	
<b>Application</b>	Curve cuts	▲▲	▲▲	▲	▲▲	▲▲	▲▲	
	Cut-outs	▲	▲	▲▲	▲	▲▲	▲	
<b>Equipment</b>	QuickIN	●	●	●	●	●	●	
	Cutting direction	8 x 45°	8 x 45°	8 x 45°	8 x 45°	8 x 45°	3 x 90°	
	Rotating round punch	●	●	●	●			
<b>Technical features</b>	Input	350 W	350 W	350 W	350 W	350 W	1 200 W	
	Strokes	1 000 - 1 800 1/min	1 000 - 1 800 1/min	800 1/min	800 - 1 500 1/min	500 - 1 000 1/min	750 1/min	750 1/min
	Cutting speed	2,3 m/min	2,3 m/min	1,9 m/min	2,7 m/min	1 m/min	1,3 m/min	1,3 m/min
	Weight according to EPTA	1,8 kg	1,8 kg	1,8 kg	1,9 kg	1,8 kg	3,5 kg	3,8 kg
	Steel up to 400 N/mm <sup>2</sup>	1,3 mm	1,3 mm	1,6 mm	1,6 mm	2 mm	3,5 mm	5 mm
	Steel up to 600 N/mm <sup>2</sup>	0,8 mm	0,8 mm	1 mm	1 mm	1,5 mm	2,3 mm	3,3 mm
	Steel up to 800 N/mm <sup>2</sup>	0,6 mm	0,6 mm	0,7 mm	0,7 mm	1 mm	1,8 mm	2,5 mm
	Non-ferrous metals up to 250 N/mm <sup>2</sup>	2 mm	2 mm	2,5 mm	2,5 mm	2,5 mm	3,5 mm	7 mm
	Cutting width	4 mm	4 mm	5 mm	5 mm	8 mm	14 mm	8 mm
	Immersion Ø with die	19 mm	19 mm	22 mm	24 mm	18 mm	30 mm	43 mm
Rad. of smallest curve (inside/outside)	25 / 30 mm	15 / 20 mm	30 / 35 mm	65 / 70 mm			86 / 94 mm	

▲ suitability    ▲▲ optimal suitability    ● included

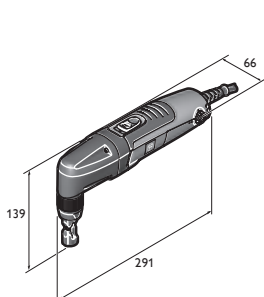

BLK 1.3 CSE

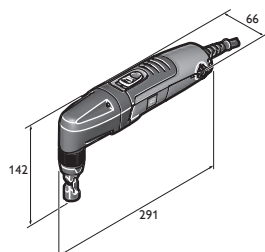

BLK 1.3 TE

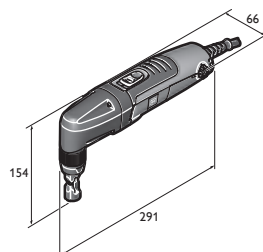

BLK 1.6 E

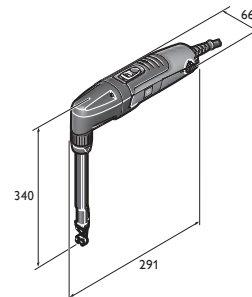

BLK 1.6 LE

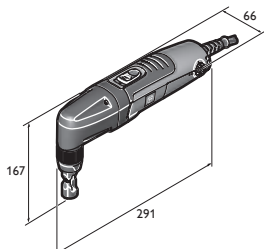

BLK 2.0 E

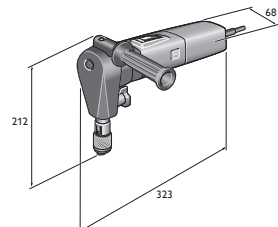

BLK 3.5

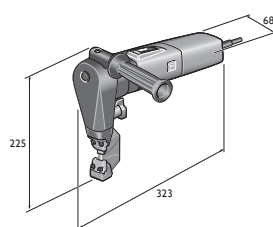

BLK 5.0

**BLK 1.3 TE**

Compact and rapid nibbler for trapezoid sheet metals.



For accessories, see page 132  
For cordless variant of tool,  
see page 48

Input	W	350
Output	W	210
Strokes	1/min	1 000 - 1 800
Cutting speed	m/min	2,3
Steel up to 400 N/mm <sup>2</sup>	mm	1,3
Steel up to 600 N/mm <sup>2</sup>	mm	0,8
Steel up to 800 N/mm <sup>2</sup>	mm	0,6
Non-ferrous metals up to 250 N/mm <sup>2</sup>	mm	2
Cutting width	mm	4
Immersion Ø with die	mm	19
Rad. of smallest curve (inside/outside)	mm	25 / 30
Cable with plug	m	5
Weight according to EPTA	kg	1,8
<b>Part number</b>		<b>7 232 41 60 00 0</b>
<b>EAN</b>		<b>4014586870069</b>
<b>Price in € [PC01]</b>		<b>535,50</b>

**FEIN benefits:**

- ▶ Cutting direction setting can be changed in 45° steps up to 360° using tool-free pivoting cutting head.
- ▶ 2.3 m/min cutting speed for excellent work progress.
- ▶ Optimum ergonomics with a handle up to 20% slimmer because of its extremely thin drive head.
- ▶ Chip protection mesh on vent slots.
- ▶ Low operating costs due to long tool life of punch and die.
- ▶ Brief overlapping area up to 2.6 mm.
- ▶ Rotating punch for a service life which is now up to 30% longer.
- ▶ QuickIN clamping system.
- ▶ Stainless steel up to 0.6 mm.
- ▶ Motor with outstanding performance and stability.
- ▶ 5 metre cable.

**Price includes:**

- 1 die for trapezoidal sheet metal (3 01 09 170 00 1),
- 1 punch (6 36 02 050 00 0)

**BLK 1.3 CSE**

Compact and rapid nibbler for corrugated sheet metals.



For accessories, see page 132  
For cordless variant of tool,  
see page 48

Input	W	350
Output	W	210
Strokes	1/min	1 000 - 1 800
Cutting speed	m/min	2,3
Steel up to 400 N/mm <sup>2</sup>	mm	1,3
Steel up to 600 N/mm <sup>2</sup>	mm	0,8
Steel up to 800 N/mm <sup>2</sup>	mm	0,6
Non-ferrous metals up to 250 N/mm <sup>2</sup>	mm	2
Cutting width	mm	4
Immersion Ø with die	mm	19
Rad. of smallest curve (inside/outside)	mm	15 / 20
Cable with plug	m	5
Weight according to EPTA	kg	1,8
<b>Part number</b>		<b>7 232 42 60 00 0</b>
<b>EAN</b>		<b>4014586870137</b>
<b>Price in € [PC01]</b>		<b>535,50</b>

**FEIN benefits:**

- ▶ Optimum ergonomics with a handle up to 20% slimmer because of its extremely thin drive head.
- ▶ Cutting direction setting can be changed in 45° steps up to 360° using tool-free pivoting cutting head.
- ▶ 2.3 m/min cutting speed for excellent work progress.
- ▶ QuickIN clamping system.
- ▶ Motor with outstanding performance and stability.

**Price includes:**

- 1 die for corrugated sheet metal (3 01 09 169 00 9),
- 1 punch (6 36 02 050 00 0)

**BLK 1.6 E**

Universal nibbler for sheets, profiles, trapezoid and corrugated sheet metals.



For accessories, see page 132  
For cordless variant of tool,  
see page 48

Input	W	350
Output	W	210
Strokes	1/min	800
Cutting speed	m/min	1,9
Steel up to 400 N/mm <sup>2</sup>	mm	1,6
Steel up to 600 N/mm <sup>2</sup>	mm	1
Steel up to 800 N/mm <sup>2</sup>	mm	0,7
Non-ferrous metals up to 250 N/mm <sup>2</sup>	mm	2,5
Cutting width	mm	5
Immersion Ø with die	mm	22
Rad. of smallest curve (inside/outside)	mm	30 / 35
Cable with plug	m	5
Weight according to EPTA	kg	1,8
<b>Part number</b>		<b>7 232 38 60 00 0</b>
<b>EAN</b>		<b>4014586869858</b>
<b>Price in € [PC01]</b>		<b>535,50</b>

**FEIN benefits:**

- ▶ Almost indestructible. Ideal for flexible and universal use with sheet thickness up to 1.6 mm..
- ▶ Optimum ergonomics with a handle up to 20% slimmer because of its extremely thin drive head.
- ▶ Cutting direction setting can be changed in 45° steps up to 360° using tool-free pivoting cutting head.
- ▶ QuickIN clamping system.
- ▶ High cutting speed.
- ▶ Rotating punch for a service life which is now up to 30% longer.
- ▶ Low operating costs due to long tool life of punch and die.
- ▶ Motor with outstanding performance and stability.
- ▶ Chip protection mesh on vent slots.
- ▶ 5 metre cable.
- ▶ Stainless steel up to 0.7 mm.
- ▶ Retrofittable trapezoid profile set up to 160 mm deep channels.

**Price includes:**

- 1 die holder for sheet metal and corrugated sheet metal,
- 1 die (3 01 09 141 00 3), 1 punch (6 36 02 048 00 4)

**BLK 1.6 LE**

Compact nibbler for deep-channel trapezoidal sheet metals in roof and façade construction.



For accessories, see page 132

Input	W	350
Output	W	210
Strokes	1/min	800 - 1 500
Cutting speed	m/min	2,7
Steel up to 400 N/mm <sup>2</sup>	mm	1,6
Steel up to 600 N/mm <sup>2</sup>	mm	1
Steel up to 800 N/mm <sup>2</sup>	mm	0,7
Non-ferrous metals up to 250 N/mm <sup>2</sup>	mm	2,5
Cutting width	mm	5
Immersion Ø with die	mm	24
Rad. of smallest curve (inside/outside)	mm	65 / 70
Cable with plug	m	5
Weight according to EPTA	kg	1,9
<b>Part number</b>		<b>7 232 39 60 00 0</b>
<b>EAN</b>		<b>4014586869926</b>
<b>Price in € [PC01]</b>		<b>773,85</b>

**FEIN benefits:**

- ▶ The specialist when it comes to zero compromise work on trapezoidal sheet metals with deep channels of up to 160 mm.
- ▶ Optimum ergonomics with a handle up to 20% slimmer because of its extremely thin drive head.
- ▶ Cutting direction setting can be changed in 45° steps up to 360° using tool-free pivoting cutting head.
- ▶ QuickIN clamping system.
- ▶ High cutting speed.
- ▶ Motor with outstanding performance and stability.
- ▶ Chip protection mesh on vent slots.
- ▶ 5 metre cable.
- ▶ Stainless steel up to 0.7 mm.

**Price includes:**

1 cutting head, 1 die for trapezoidal sheet metal (3 13 09 122 00 5), 1 punch (6 36 02 049 00 8), 1 wearing plate

**BLK 2.0 E**

Compact nibbler with unlimited curve precision for corners and edges.



For accessories, see page 132

Input	W	350
Output	W	210
Strokes	1/min	500 - 1 000
Cutting speed	m/min	1
Steel up to 400 N/mm <sup>2</sup>	mm	2
Steel up to 600 N/mm <sup>2</sup>	mm	1,5
Steel up to 800 N/mm <sup>2</sup>	mm	1
Non-ferrous metals up to 250 N/mm <sup>2</sup>	mm	2,5
Cutting width	mm	8
Immersion Ø with die	mm	18
Cable with plug	m	5
Weight according to EPTA	kg	1,8
<b>Part number</b>		<b>7 232 40 60 00 0</b>
<b>EAN</b>		<b>4014586869995</b>
<b>Price in € [PC01]</b>		<b>739,20</b>

**FEIN benefits:**

- ▶ High curve precision due to special cutting head geometry. Nibbler can turn on the spot.
- ▶ Especially well-suited for cutting edged sheet metals with a minimum bend radius of 3 mm.
- ▶ Cutting direction setting can be changed in 45° steps up to 360° using tool-free pivoting cutting head.
- ▶ QuickIN clamping system.
- ▶ Optimal ergonomics.
- ▶ Motor with outstanding performance and stability.
- ▶ Ideal for cut-outs.
- ▶ Optimally suited for template cuts.
- ▶ Chip protection mesh on vent slots.
- ▶ 5 metre cable.
- ▶ Stainless steel up to 1.0 mm.

**Price includes:**

1 cutting head, 1 die (3 13 09 040 00 2), 1 punch (6 36 02 051 00 9)

**BLK 3.5**

Powerful nibbler with unlimited curve-compatibility for grooves and cut-outs.



For accessories, see page 132

Input	W	1 200
Output	W	750
Strokes	1/min	750
Cutting speed	m/min	1,3
Steel up to 400 N/mm <sup>2</sup>	mm	3,5
Steel up to 600 N/mm <sup>2</sup>	mm	2,3
Steel up to 800 N/mm <sup>2</sup>	mm	1,8
Non-ferrous metals up to 250 N/mm <sup>2</sup>	mm	3,5
Cutting width	mm	14
Immersion Ø with die	mm	30
Weight according to EPTA	kg	3,5
<b>Part number</b>	<b>7 232 30 00 23 0</b>	
<b>EAN</b>	<b>4014586848655</b>	
<b>Price in € [PC01]</b>	<b>1.456,35</b>	

**FEIN benefits:**

- ▶ Ideally suited for grooves and cut-outs in sheet metals, tool can turn on the spot.
- ▶ Cutting direction can be adjusted in 90° steps without the need for tools.
- ▶ QuickIN clamping system for quick, tool-free punch and die changes.
- ▶ Optimum power-to-weight ratio.
- ▶ Long tool life, punches can be reground.
- ▶ Motor with outstanding performance and stability.
- ▶ Warp-free cutting of flat and bent sheet metal.
- ▶ Optimally suited for template cuts.
- ▶ Chip protection mesh on vent slots.
- ▶ Handle can be rotated 180°.
- ▶ 5 metre cable.
- ▶ Stainless steel up to 1.8 mm.
- ▶ Wide range of accessories.

**Price includes:**

1 cutting head, 1 die (3 13 09 093 00 3), 1 punch (3 13 09 097 00 2), 1 additional handle

**BLK 5.0**

Powerful nibbler for heavy dismantling and cutting applications.



For accessories, see page 132

Input	W	1 200
Output	W	750
Strokes	1/min	750
Cutting speed	m/min	1,3
Steel up to 400 N/mm <sup>2</sup>	mm	5
Steel up to 600 N/mm <sup>2</sup>	mm	3,3
Steel up to 800 N/mm <sup>2</sup>	mm	2,5
Non-ferrous metals up to 250 N/mm <sup>2</sup>	mm	7
Cutting width	mm	8
Immersion Ø with die	mm	43
Rad. of smallest curve (inside/outside)	mm	86 / 94
Cable with plug	m	5
Weight according to EPTA	kg	3,8
<b>Part number</b>	<b>7 232 31 00 23 9</b>	
<b>EAN</b>	<b>4014586848662</b>	
<b>Price in € [PC01]</b>	<b>2.212,35</b>	

**FEIN benefits:**

- ▶ Powerful 1 200 watt motor for outstanding performance while maintaining excellent ergonomics.
- ▶ Cuts over 90° edges, for example on guard rails or tanks.
- ▶ Cutting direction can be adjusted in 90° steps without the need for tools.
- ▶ Optimum power-to-weight ratio.
- ▶ Long tool life of punch and die.
- ▶ Chip protection mesh on vent slots.
- ▶ Handle can be rotated 180°.
- ▶ 5 metre cable.
- ▶ Stainless steel up to 2.5 mm.
- ▶ Wide range of accessories.

**Price includes:**

1 cutting head, 1 die (3 13 09 107 00 0), 1 punch (3 13 09 110 00 4), 1 additional handle

**General accessories**



**Tool case**  
Plastic, inner dimensions: 470 x 275 x 116 mm

Part number	Price in €
3 39 01 118 01 0	37,26



**Plastic box**  
Box insert with lockable lid for small parts and accessories, suitable for tool box 3 39 01 118 01 0, max 5 items/box.

Part number	Price in €
3 39 01 119 00 0	3,97



**Cutting paste**  
Lubricating agents for working on sheet metals.

Part number	Price in €
3 21 32 020 12 9	14,11

**Accessories for BLK 1.3 CSE**

**Die**  
for corrugated sheet metal

No. in pack pcs	Part number	Price in €
1	3 01 09 169 00 9	144,97
2	3 01 09 169 04 0	232,46

**Accessories for BLK 1.3 TE**

**Punches and dies in a set**  
consisting of 5 x punches 6 36 02 050 00 0 and 1 x die 3 01 09 170 00 1.

Part number	Price in €
3 01 09 170 00 0	200,33

**Accessories for BLK 2.0 E**

**Die**  
RSS 636

Part number	Price in €
3 13 09 040 00 2	51,18



**Punch**

Part number	Price in €
6 36 02 051 00 9	48,41



**Punches and dies in a set**  
Consisting of: 1 die 6 36 02 051 00 9 and 1 punch 3 13 09 040 00 2

Part number	Price in €
6 36 02 051 01 8	98,70

**Accessories for BLK 1.6 LE**

**Punches and dies**  
in the set, for profile set 160, including wear plate, screws and key  
Profile set 160

Part number	Price in €
6 36 02 049 01 7	131,11



**Punch**

No. in pack pcs	Part number	Price in €
1	6 36 02 049 00 8	56,50
2	6 36 02 049 04 0	102,09
5	6 36 02 049 05 0	226,30

**Die**

No. in pack pcs	Part number	Price in €
1	3 13 09 122 00 5	65,50
2	3 13 09 122 02 0	118,06
5	3 13 09 122 03 0	279,17

**Wearing plate**  
Profile set 160

Part number	Price in €
3 13 09 121 00 2	11,12

**Accessories for BLK 1.6 E**



**Punch**

No. in pack pcs	Part number	Price in €
1	6 36 02 048 00 4	19,09
5	6 36 02 048 04 0	76,25
10	6 36 02 048 05 0	132,81



**Die**

No. in pack pcs	Part number	Price in €
1	3 01 09 141 00 3	48,70
2	3 01 09 141 02 0	77,50
5	3 01 09 141 03 0	169,73



**Punches and dies**  
in set, each consisting of 1x punch 6 36 02 048 00 4 and 1x die 3 01 09 141 00 3.

Part number	Price in €
6 36 02 048 01 3	59,66



**Die holder**  
for trapezoidal sheet metal and corrugated sheet metal

Part number	Price in €
3 01 09 154 00 7	192,84



**Profile set 160**  
For deep-channel trapezoidal sheet metals (85-160 mm), incl. 1 punch, die and wearing plate.

Part number	Price in €
9 26 02 071 01 9	350,70

**Accessories for BLK 5.0****Punches and dies in a set**

up to 5.0 mm steel plate (400 N/mm<sup>2</sup>), consisting of: 1 punch  
3 13 09 110 00 4 and 1 die 3 13 09 107 00 0

Part number	Price in €
3 13 09 110 01 3	168,65

**Punches and dies in a set**

up to 3.0 mm stainless steel plate (600 N/mm<sup>2</sup>), consisting of:  
1 punch 3 13 09 134 00 6 and 1 die 3 13 09 108 00 8

Part number	Price in €
3 13 09 134 01 5	168,65

**Chips bag**

Part number	Price in €
3 13 09 114 00 8	86,33

**Punch**

up to 7.0 mm aluminium steel plate (250 N/mm<sup>2</sup>)  
up to 5.0 mm steel sheet (400 N/mm<sup>2</sup>)

Part number	Price in €
3 13 09 110 00 4	77,57

**Punch**

up to 3.0 mm stainless steel plate (600 N/mm<sup>2</sup>)

Part number	Price in €
3 13 09 134 00 6	77,57

**Die**

for steel sheet up to 5 mm thickness

Part number	Price in €
3 13 09 107 00 0	95,19

**Die**

up to 3.0 mm stainless steel plate (600 N/mm<sup>2</sup>)

Part number	Price in €
3 13 09 108 00 8	95,19

**Die**

up to 7.0 mm aluminium steel plate (250 N/mm<sup>2</sup>)  
up to 5.0 mm steel sheet (400 N/mm<sup>2</sup>)

Part number	Price in €
3 13 09 109 00 2	95,19

**Accessories for BLK 3.5****Punch**

for steel sheet up to 400 N/mm<sup>2</sup>

Part number	Price in €
3 13 09 097 00 2	53,38

**Punch**

for stainless steel up to 800 N/mm<sup>2</sup>

Part number	Price in €
3 13 09 098 00 0	77,75

**Die**

for steel sheet up to 400 N/mm<sup>2</sup>

Part number	Price in €
3 13 09 093 00 3	58,83

**Die**

for stainless steel up to 800 N/mm<sup>2</sup>

Part number	Price in €
3 13 09 094 00 1	67,00

**Accessories for BLK 1.3 TE, BLK 1.3 CSE****Punch**

for steel sheet up to 400 N/mm<sup>2</sup>

Plate thickness mm	No. in pack pcs	Part number	Price in €
1,3	1	6 36 02 050 00 0	16,83
1,3	5	6 36 02 050 03 0	67,64
1,3	10	6 36 02 050 01 0	118,06

**Die**

for trapezoidal sheet metal

No. in pack pcs	Part number	Price in €
1	3 01 09 170 00 1	164,77
2	3 01 09 170 04 0	261,98

**Punches and dies in a set**

consisting of 5 x punches 6 36 02 050 00 0 and 1 x die  
3 01 09 169 00 9.

Part number	Price in €
3 01 09 169 03 0	183,18





## Tried and tested technology for perfect results: sawing and milling from FEIN.

High grade steel processing, building kitchens, metal processing and industry – FEIN jigsaws are designed perfectly for the high loads experienced when working with steel and stainless steel. As genuine specialist metal tools, FEIN jigsaws maintain a constant stroke and therefore constant cutting speed even under extreme load levels. The sturdy metal housing and resilient gears make these legendary endurance tools, often last decades. The FEIN range is supplemented by tools for pipe processing: jigsaws for pipes with a diameter of up to max. 440 mm, mainly for plant construction and community supply connections. FEIN also manufactures special pipe milling machines for pipes with a diameter of up to approx. 3 000 mm for plant and pipeline construction.



---

### Jigsaws Page 136

Optimum cutting speed with minimal wear.

---

### Pipe Saws Page 139

Optimum cutting speed with minimal wear.

---

### Construction cutter Page 143

Remove old windows with no dust or damage to the wall.



	<b>ASte 638</b>	<b>ASt 638</b>	
	Metal jigsaws with continuously variable speed control and stainless steel base plate for unsurpassed precision, robustness and service life.	Metal jigsaws with unsurpassed precision, robustness and service life.	
<b>Page</b>	137	137	
<b>Technical features</b>	Input	450 W	350 W
	Strokes	1 050 - 2 600 1/min	3 350 1/min
	Stroke of blade	20 mm	20 mm
	Weight according to EPTA	2,3 kg	2,2 kg
	Max. cutting capacity		
	Stainless steel (V2A)	6 mm	3 mm
	Steel (St 37)	10 mm	8 mm
	Hard/soft wood and plywood	60 / 50 mm	50 / 40 mm
	Hard particle / fibre-glass materials	30 / 30 mm	25 / 20 mm
	Radius of smallest curve		
steel/woods and plastics	8 / 6 mm	8 / 6 mm	

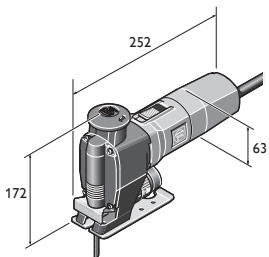

ASt 638  
ASte 638



**ASte 638**

Metal jigsaws with continuously variable speed control and stainless steel base plate for unsurpassed precision, robustness and service life.



For accessories, see page 138

Input	W	450
Output	W	245
Strokes	1/min	1 050 - 2 600
Stroke of blade	mm	20
Stainless steel (V2A)	mm	6
Steel (St 37)	mm	10
alu, copper, brass	mm	15 / 10
Hard/soft wood and plywood	mm	60 / 50
Hard particle / fibre-glass materials	mm	30 / 30
steel/woods and plastics	mm	8 / 6
Cable with plug	m	5
Weight according to EPTA	kg	2,3
<b>Part number</b>		<b>7 234 15 00 23 0</b>
<b>EAN</b>		<b>4014586839332</b>
<b>Price in € [PC01]</b>		<b>485,10</b>

**FEIN benefits:**

- ▶ Tool concept for optimum results in metals, stainless steel, insulation material (sandwich) and hardwood. With extremely robust 4 mm thick stainless steel base plate.
- ▶ Continuously variable, electronic speed setting for optimum cutting speed and saw blade service life
- ▶ Excellent ergonomics.
- ▶ Outstanding smooth running thanks to precisely balanced weight distribution.
- ▶ Swarf removal can be switched between extraction or blowing.

**Price includes:**

- 2 packs of saw blades, 1 anti-chipping protector, 1 Chip protection additional

**ASt 638**

Metal jigsaws with unsurpassed precision, robustness and service life.



For accessories, see page 138

Input	W	350
Output	W	200
Strokes	1/min	3 350
Stroke of blade	mm	20
Stainless steel (V2A)	mm	3
Steel (St 37)	mm	8
alu, copper, brass	mm	10 / 10
Hard/soft wood and plywood	mm	50 / 40
Hard particle / fibre-glass materials	mm	25 / 20
steel/woods and plastics	mm	8 / 6
Cable with plug	m	5
Weight according to EPTA	kg	2,2
<b>Part number</b>		<b>7 234 17 00 23 9</b>
<b>EAN</b>		<b>4014586841670</b>
<b>Price in € [PC01]</b>		<b>437,85</b>

**FEIN benefits:**

- ▶ Extremely low levels of wear and maintenance even when used in very demanding industrial applications.
- ▶ Machine concept for optimum results in metals, insulation materials (sandwich) and hard wood.
- ▶ Excellent ergonomics.
- ▶ Outstanding smooth running thanks to precisely balanced weight distribution.
- ▶ Swarf removal can be switched between extraction or blowing.

**Price includes:**

- 2 packs of saw blades, 1 anti-chipping protector

**Saw blades for metal and sandwich material**

	METAL	ALU	Cu Ni Mn Zn	STAINLESS INOX NIROSTA	PVC	SANDWICH			Qualität/Quality	No. in pack pcs	Part number	Price in €
	< 1,2		< 1,2				77	0,7	HSS	5	6 35 03 060 01 0	11,64
	< 1,2						100	0,7	HSS	5	6 35 03 076 01 0	15,94
	< 2,0	< 2,0	< 2,0	< 2,0	< 4,0		88	1,2	HSS	5	6 35 03 035 01 1	10,46
	< 2,0	< 2,0	< 2,0		< 4,0	< 70,0	120	1,2	HSS	5	6 35 03 077 01 4	18,31
	< 10,0	< 8,0	< 10,0	< 6,0	< 8,0		88	2,0	HSS	5	6 35 03 036 01 4	10,46
	< 10,0	< 8,0	< 10,0		< 30,0	< 120	180	2	BIM	5	6 35 03 114 01 0	24,71
	< 2,0	< 2,0	< 2,0	< 2,0	< 4,0		88	1,2	BIM	5	6 35 03 112 01 0	13,70
	< 10,0	< 8,0	< 10,0	< 6,0	< 8,0		88	2,0	BIM	5	6 35 03 113 01 0	13,70
	< 6,0	< 15,0					100	3,0	BIM	5	6 35 03 088 01 1	12,89

**Saw blades for wood and other materials**

	FIBREGLASS		PVC						Qualität/Quality	No. in pack pcs	Part number	Price in €
			< 25,0	< 25,0		77	2		HCS	5	6 35 03 087 01 3	10,46
			< 40,0	< 15,0	< 25,0		88	3,0	HCS	5	6 35 03 037 01 8	10,46
			< 50,0	< 30,0	< 50,0		88	4,0	HCS	5	6 35 03 038 01 6	10,46
			< 60,0	< 30,0	< 60,0		100	4,0	HCS	5	6 35 03 082 01 0	11,66
						77			HM	5	6 35 03 089 01 5	30,18
	< 25,0		< 30,0			88	4,0		HSS	5	6 35 03 039 01 0	12,44
	< 10,0					77			Diamond	1	6 35 03 061 01 9	41,66

**General accessories**



**Tool case**  
Plastic, inner dimensions: 470 x 275 x 116 mm

Part number Price in €  
3 39 01 118 01 0 37,26



**Plastic box**  
Box insert with lockable lid for small parts and accessories, suitable for tool box 3 39 01 118 01 0, max 5 items/box.

Part number Price in €  
3 39 01 119 00 0 3,97



**Cutting paste**  
Lubricating agents for working on sheet metals.

Part number Price in €  
3 21 32 020 12 9 14,11

**Shoe plate**

Extended, for sawing profiles and profiled insulation material. Length approx. 340 mm.

Part number Price in €  
3 27 14 084 00 8 90,91



**Anti-chipping protector**  
Pack of 5

Part number Price in €  
3 14 28 102 01 6 9,16



**Chipping protector**  
for ASt(e) 638

Part number Price in €  
3 27 14 088 00 7 4,54



**Hose sleeve**  
for the connection of FEIN Electric Power Tools with dust extraction

Ø mm	Part number	Price in €
32	3 05 17 028 00 7	2,49
27	3 05 17 029 00 1	3,02



**Connecting piece**  
Universal device to connect power tools and accessories with dust extraction to vacuum cleaner. Flexible rubber sleeve, length 70 mm, inner diameter 31.5 mm.

Part number Price in €  
3 13 22 771 00 9 4,91



	<b>AStx 649-1</b>	<b>AStxe 649-1</b>	<b>STS 325 R</b>	
	Powerful hacksaw for pipes and profiled sections.	Powerful hacksaw for pipes and profiled sections with continuously variable speed adjustment.	Compressed air hacksaw for pipes and profiled sections.	
<b>Page</b>	140	140	140	
<b>Technical features</b>	Input	750 W	750 W	
	Strokes	350 1/min	100 - 350 1/min	330 1/min
	Stroke of blade	60 mm	60 mm	60 mm
	Operating pressure			6 bar
	Air consumption			1,45 m <sup>3</sup> /min
	Weight according to EPTA	6,1 kg	6,4 kg	7,2 kg
	Pipes up to Ø	440 * mm	400 * mm	440 * mm
profiles up to W x H	290 x 550 mm	290 x 550 mm	290 x 500 mm	

\* With chain extension.

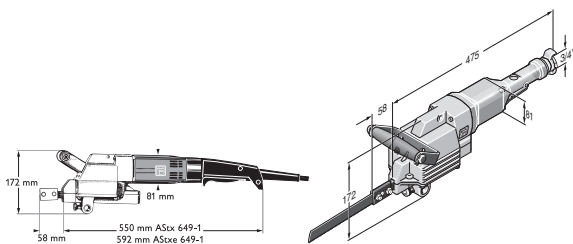

AStx 649-1  
AStxe 649-1

STS 325 R

**AStx 649-1**

Powerful hacksaw for pipes and profiled sections.



For accessories, see page 141

Input	W	750
Output	W	480
Strokes	1/min	350
Stroke of blade	mm	60
Pipes up to Ø	mm	440 *
profiles up to W x H	mm	290 x 550
Cable with plug	m	2,5
Weight according to EPTA	kg	6,1
<b>Part number</b>	<b>7 234 22 00 23 0</b>	
<b>EAN</b>	<b>4014586858470</b>	
<b>Price in € [PC01]</b>	<b>1.832,25</b>	

**FEIN benefits:**

- ▶ Ideally suited for trimming pipes and shaped section made of steel, cast-iron, autoclaved aerated concrete and plastics.
- ▶ Clamp and feed device available for profiles and pipes from Ø 80 mm to Ø 400 mm.
- ▶ Especially suitable for sandwich material and layers of different materials.
- ▶ Adjustable clamping devices permit mitre cuts up to 45° as well.
- ▶ \* With chain extension.

**Price includes:**

2 saw blades, 1 additional handle, 1 set of keys

**AStxe 649-1**

Powerful hacksaw for pipes and profiled sections with continuously variable speed adjustment.



For accessories, see page 141

Input	W	750
Output	W	480
Strokes	1/min	100 - 350
Stroke of blade	mm	60
Pipes up to Ø	mm	400 *
profiles up to W x H	mm	290 x 550
Cable with plug	m	2,5
Weight according to EPTA	kg	6,4
<b>Part number</b>	<b>7 234 23 00 23 0</b>	
<b>EAN</b>	<b>4014586858500</b>	
<b>Price in € [PC01]</b>	<b>1.915,20</b>	

**FEIN benefits:**

- ▶ Ideally suited for trimming pipes and shaped section made of steel, cast-iron, autoclaved aerated concrete and plastics.
- ▶ Clamp and feed device available for profiles and pipes from Ø 80 mm to Ø 400 mm.
- ▶ Especially suitable for sandwich material and layers of different materials.
- ▶ Variable electronic speed control for optimum cutting speed.
- ▶ Adjustable clamping devices permit mitre cuts up to 45° as well.
- ▶ \* With chain extension.

**Price includes:**

2 saw blades, 1 additional handle, 1 set of keys

**STS 325 R**

Compressed air hacksaw for pipes and profiled sections.



For accessories, see page 141

Operating pressure	bar	6
Air consumption	m <sup>3</sup> /min	1,45
Output	W	1 100
Strokes	1/min	330
Stroke of blade	mm	60
Pipes up to Ø	mm	440 *
profiles up to W x H	mm	290 x 500
Weight according to EPTA	kg	7,2
<b>Part number</b>	<b>7 534 08 00 00 0</b>	
<b>EAN</b>	<b>4014586855639</b>	
<b>Price in € [PC01]</b>	<b>2.350,95</b>	

**FEIN benefits:**











- ▶ Ideally suited for trimming pipes and shaped section made of steel, cast-iron, autoclaved aerated concrete and plastics.
- ▶ Clamp and feed device available for profiles and pipes from Ø 80 mm to Ø 400 mm.
- ▶ Adjustable clamping devices permit mitre cuts up to 45° as well.
- ▶ Clamp and feed device.
- ▶ Adjustable clamping fixtures.
- ▶ \* With chain extension.

**Price includes:**

2 saw blades, 1 set of keys, 1 additional handle, 1 hose coupling

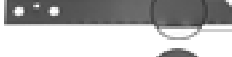







**Saw blades**

	Non-ferrous metals and steel 400 N/mm <sup>2</sup>	Steel more than 400 N/mm <sup>2</sup> and cast iron	Miscellaneous	Length	Tooth spacing	Thick-ness	Weight (net)	Material	Part number	Price in €
				mm	mm	mm	kg			
	x	x	≤ Ø 80	200	1,0	1,5	0,06	HSS	6 35 03 067 00 6	8,73
	x	x	≤ Ø 80	200	1,6	1,5	0,06	HSS	6 35 03 066 00 2	8,40
	x	x	≤ Ø 170 <sup>1</sup>	300	1,6	1,5	0,06	HSS	6 35 03 063 00 7	10,56
	x	x	≤ Ø 260 <sup>1</sup>	400	1,6	1,5	0,125	HSS	6 35 03 064 00 5	14,63
	x	x	≤ Ø 350 <sup>2</sup>	500	1,8	2,0	0,18	HSS	6 35 03 072 00 2	29,84
	x	x	≤ Ø 440 <sup>2</sup>	600	1,8	2,0	0,21	HSS	6 35 03 073 00 6	36,25
	x	x		300	2,1	1,5	0,08	HSS	6 35 03 070 00 0	10,47
	x		*	530	2,1	1,5	0,170	HSS	6 35 03 069 00 8	19,03
	x (AL)		Plastic	200	3,2	1,5	0,06	HSS	6 35 03 065 00 9	6,87
	x (AL)		Plastic	400	3,2	1,5	0,125	HSS	6 35 03 068 00 4	14,62
			PE pipes, porous concrete	300	6,3	1,5	0,08		6 35 03 071 00 9	7,35
			PE pipes, porous concrete *	530	6,3	1,5	0,170		6 35 03 040 00 3	13,21



**HD saw blades**

Special saw blades for cutting steel and stainless steel. HD saw blades are noted for their long service life and rapid sawing speed. Give them a try: it will pay off.

	Non-ferrous metals and steel 400 N/mm <sup>2</sup>	Steel more than 400 N/mm <sup>2</sup> and cast iron	Miscellaneous	Length	Tooth spacing	Thick-ness	Weight (net)	Material	Part number	Price in €
				mm	mm	mm	kg			
	x	x	≤ Ø 170 <sup>1</sup>	300	1,6	2,0	0,08	HSS	6 35 03 093 00 4	18,85
	x	x	≤ Ø 350 <sup>2</sup>	500	1,8	2,0	0,18	HSS	6 35 03 099 00 5	34,76
	x	x	≤ Ø 325 *	530	2,1	1,6	0,17	HSS	6 35 03 100 00 6	27,13
	x	x	≤ Ø 260 <sup>1</sup>	400	2,1	2,0	0,175	HSS	6 35 03 094 00 2	25,18
	x	x	≤ Ø 260 <sup>1</sup>	400	3,2	2,0	0,175	HSS	6 35 03 095 00 6	25,18
	x	x	≤ Ø 440 <sup>2</sup>	600	1,8	2,0	0,21	HSS	6 35 03 098 00 1	42,48

**TD saw blades**

TD saw blades are suitable for cutting wet and dry pipes. They are noted for rapid sawing speed and for clean cuts.

		for ductile cast-iron pipes, also with cement mortar cladding and cast iron pipes	Pipes Ø (DN)	Length	Coating length	Thick-ness	Weight	Material	Part number	Price in €
			mm	mm	mm	mm	kg			
	x		80 - 150 <sup>3</sup>	320	260	2,2	0,110		6 35 03 096 01 8	178,50
	x		80 - 300 <sup>3</sup>	490	430	2,9	0,220		6 35 03 097 01 2	237,30

\* only with saw blade guide 9 06 06 002 00 9

<sup>1</sup> for use with the FEIN clamp and feed device 9 07 02 005 00 0 or clamping device 9 07 02 004 00 6

<sup>2</sup> only with chain extension up to Ø 440 mm, chain 3 02 31 003 00 3 and bolt 3 02 16 130 00 4 also required

<sup>3</sup> to be used with the FEIN clamp and feed device 9 07 02 005 00 0

**General accessories**



**Tool case**  
Metal

Width mm	Length mm	Height mm	Part number	Price in €
240	690	160	3 39 01 022 01 4	47,78



**Cutting paste**  
Lubricating agents for working on sheet metals.

Part number	Price in €
3 21 32 020 12 9	14,11



**FEIN clamp and feed device**  
(W x D x H) 280 x 285 x 395 mm, for pipes and circular material with an outside dia. of 80 mm to 400 mm

Part number	Price in €
9 07 02 005 00 0	1.920,45

**Protective steel jaws**  
for avoiding damage to the surface of the pipe, 4 pieces required

Part number	Price in €
3 13 27 064 00 8	48,83



**Cleaning block**  
Rhombus for cleaning the carbide tools and diamond-coated tools.

Part number	Price in €
6 37 19 007 01 0	20,67



**Clamping fixture**  
for pipes from Ø 100 mm up to 325 mm, only with extension of the chain up to Ø 440 mm, chain 3 02 31 003 00 3 and bolt 3 02 16 130 00 4 necessary

Part number	Price in €
9 07 02 004 00 6	334,95



**Clamping fixture**  
for profiles up to 290 mm width at max height 550 mm

Part number	Price in €
9 07 02 003 00 8	269,85



**Saw blade guide**  
for pipes up to Ø 325 mm only with saw blade 530 mm length, guide to the centre of the pipe

Part number	Price in €
9 06 06 002 00 9	265,61



**Support**  
for free hand working

Part number	Price in €
3 27 14 062 02 3	200,55

**Splitter wedge**  
Prevents the jamming of the saw blade

Part number	Price in €
6 33 05 006 00 8	9,59

**Accessory STS 325 R**

**Hose coupling**

Part number	Price in €
4 11 40 004 00 7	25,49



**MF 14-180**

Extremely powerful and robust construction cutter for removing old windows.



For accessories, see page 143

Input	W	1 200
Output	W	750
Speed, no load	1/min	7 000
Diamond wheel Ø	mm	180
Cutting depth	mm	0 - 50
Cable with plug	m	4
Weight according to EPTA	kg	4,1
<b>Part number</b>		<b>7 238 14 00 23 0</b>
<b>EAN</b>		<b>4014586865744</b>
<b>Price in € [PC01]</b>		<b>1.056,30</b>

**FEIN benefits:**

- ▶ Precise cuts without any damage to the walls.
- ▶ Cut passes just 2 mm along the old window frame.
- ▶ Dust-free operation with closed suction container.
- ▶ FEIN high-power motor.
- ▶ Top-quality diamond wheel.
- ▶ Ideal addition: FEIN SUPERCUT for cutting window frames.
- ▶ Cutting depth can be precisely set with the depth stop.
- ▶ Firm handle.

**Price includes:**

1 FEIN construction cutter MF 14-180, 1 diamond wheel, Ø 180 mm, 1 plastic carrying case

**Construction cutter**

**General accessories**



**Diamond wheel**

Ø 180 mm, special retainer for MF 14-180.

Part number	Price in €
6 35 02 146 01 1	104,34



**Connecting piece**

Universal device to connect power tools and accessories with dust extraction to vacuum cleaner. Flexible rubber sleeve, length 70 mm, inner diameter 31.5 mm.

Part number	Price in €
3 13 22 771 00 9	4,91



## Metal core drills – the most cost effective drilling experience.

Core drilling is an extremely efficient process: faster, quieter and more accurate than twist drilling. Since core drilling requires no predrilling or retooling, the time needed for the job can be cut by up to around 40% – on site or in the workshop. The high-quality FEIN magnet core drill units (KBM) can be used with carbide core drills and are suited to many applications such as core drilling, spiral drilling, thread cutting, countersinking and reaming. The FEIN KBB range of magnet core drill units, on the other hand, are designed solely for efficient core drilling. The same applies to the FEIN core bits. High-quality carbides, HSS steels and sophisticated cutting geometries ensure the best cutting performances and very long service life. The world's first hand-guided metal drilling

system, the FEIN KBH 25, combines the benefits of powerful hand drills and carbide-tipped core drills in one. The new drilling technology and specially developed carbide core drill bit make possible flexible, comfortable and rapid work. Whether for steel, stainless steel or aluminium: we've got the right solution for every application, thanks to our extensive range of core bits. The FEIN core drilling system will revolutionise your work!



---

**Mobile** **Page 146**  
Flexible hand-guided metal core drilling system with work progress six times faster than twist drilling.

---



---

**Economical** **Page 151**  
Economical magnetic core drills with basic functionality for drilling, which do not compromise on lifetime or performance.

---



---

**Compact** **Page 151**  
Compact magnetic core drills with minimum dimensions for core drilling in tight and difficult-to-reach spots.

---

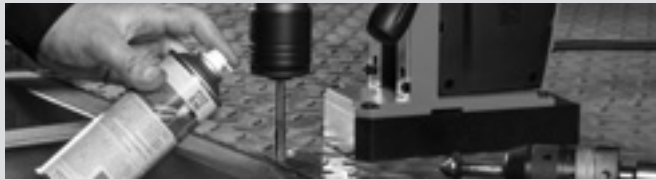

---

**Universal** **Page 158**  
High-performance universal magnetic core drills with very high quality standards for universal applications.

---



---

**Automatic** **Page 174**  
High-performance, fully automatic auto magnetic core drills for maximum efficiency and minimum physical strain.

---



	<b>KBH 25 S</b>	<b>KBH 25-2 U</b>	
	Hand-guided single-speed metal core drilling system for rapid and flexible use of core drills.	Hand-guided 2-speed metal core drilling system for universal use of core drills and twist drills.	
<b>Page</b>	147	147	
<b>Technical features</b>	Drilling diameter in steel, core drill bit	25 mm	25 mm
	Hole diameter in stainless steel, core drill	25 mm	25 mm
	Drilling diameter in aluminium, core drill bit	30 mm	30 mm
	Drilling diameter in steel, hole saws	80 mm	80 mm
	Input	1 200 W	1 200 W
	Output	680 W	680 W
	Centre drilling	0 - 1 600* 1/min	0 - 1 600 1/min
	1st gear	0 - 520* 1/min	0 - 520 1/min
	2nd gear	- 1/min	0 - 1 600 1/min
Weight according to EPTA	3,3 kg	3,4 kg	

\* No manual changeover possible.

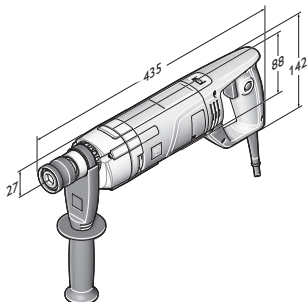

KBH 25 S  
KBH 25-2 U

**KBH 25 S**

Hand-guided single-speed metal core drilling system for rapid and flexible use of core drills.



For accessories, see page 148

Input	W	1 200
Output	W	680
Centre drilling	1/min	0 - 1 600*
1st gear	1/min	0 - 520*
2nd gear	1/min	-
Torque	Nm	50
Stall torque	Nm	50 **
Drilling diameter in steel, core drill bit	mm	25
Hole diameter in stainless steel, core drill	mm	25
Drilling diameter in aluminium, core drill bit	mm	30
Core drill, drilling depth max.	mm	20
Drilling diameter in steel, hole saws	mm	80
Hole saws, max. drilling depth	mm	4
Core drill holder		QuickIN Plus
Width across corners	mm	27
Cable with plug	m	4
Weight according to EPTA	kg	3,3
<b>Part number</b>		<b>7 271 04 61 00 0</b>
<b>EAN</b>		<b>4014586876030</b>
<b>Price in € [PC01]</b>		<b>628,95</b>

**FEIN benefits:**

- ▶ Work up to 6 times faster thanks to innovative drilling technology: 5 mm deep centre drilling at 1 600 rpm followed by disconnection of the centre bit and automatic speed change to 520 rpm to achieve the optimum cutting speed for carbide core bits. With its specially developed cutting geometry, the carbide core bit completes the desired hole diameter with little effort on the user's part.
- ▶ Can be used with all standard metals and surfaces by adjusting the speed to the task in hand.
- ▶ High level of safety thanks to torque slipping clutch. Protects the user in the event of overload by disconnecting the output side from the drive side.
- ▶ \* No manual changeover possible.
- ▶ \*\* Torque slipping clutch.
- ▶ Reversible rotation.
- ▶ FEIN high-power motor with high speed stability.
- ▶ Variable speed control.
- ▶ Infinitely variable electronic speed setting.
- ▶ Speed-controlled tacho electronics.
- ▶ Distortion-free barrel-type motor housing.
- ▶ Carbide core drill bits with optimised service life.
- ▶ Restart lock.
- ▶ Wide range of accessories.

**Price includes:**

1 cutting spray, 1 metal core drill KBH 25 S, 1 plastic carrying case, 1 additional handle, 1 centring drill bit

**KBH 25-2 U**

Hand-guided 2-speed metal core drilling system for universal use of core drills and twist drills.



For accessories, see page 148

Input	W	1 200
Output	W	680
Centre drilling	1/min	0 - 1 600
1st gear	1/min	0 - 520
2nd gear	1/min	0 - 1 600
Torque	Nm	50
Stall torque	Nm	50 **
Drilling diameter in steel, core drill bit	mm	25
Hole diameter in stainless steel, core drill	mm	25
Drilling diameter in aluminium, core drill bit	mm	30
Core drill, drilling depth max.	mm	20
Drilling diameter in steel, hole saws	mm	80
Hole saws, max. drilling depth	mm	4
Tapping		M 12
Core drill holder		QuickIN Plus
Width across corners	mm	27
Cable with plug	m	4
Weight according to EPTA	kg	3,4
<b>Part number</b>		<b>7 271 03 61 00 0</b>
<b>EAN</b>		<b>4014586876023</b>
<b>Price in € [PC01]</b>		<b>702,45</b>

**FEIN benefits:**

- ▶ Work up to 6 times faster thanks to innovative drilling technology: 5 mm deep centre drilling at 1 600 rpm followed by disconnection of the centre bit and automatic speed change to 520 rpm to achieve the optimum cutting speed for carbide core bits. With its specially developed cutting geometry, the carbide core bit completes the desired hole diameter with little effort on the user's part.
- ▶ Mechanical 2-speed gearbox with speeds of 0-1 600 rpm for efficient twist drilling and clockwise/anti-clockwise operation for cutting threads up to M12.
- ▶ High level of safety thanks to torque slipping clutch. Protects the user in the event of overload by disconnecting the output side from the drive side.
- ▶ \*\* Torque slipping clutch.
- ▶ Reversible rotation.
- ▶ FEIN high-power motor with high speed stability.
- ▶ Variable speed control.
- ▶ Infinitely variable electronic speed setting.
- ▶ Speed-controlled tacho electronics.
- ▶ Distortion-free barrel-type motor housing.
- ▶ Carbide core drill bits with optimised service life.
- ▶ Restart lock.
- ▶ Wide range of accessories.

**Price includes:**

1 metal core drill KBH 25-2 U, 1 centring drill bit, 1 additional handle, 1 cutting spray, 1 quick-action chuck Ø 3-16 mm, 1 plastic carrying case



**Carbide core drill**



**Carbide core drill bit with QuickIN PLUS holder**  
 Outstanding cutting performance in all common metals.  
 Metric dimensions, cutting depth 20 mm, drilling diameter in steel up to 25 mm, drilling diameter in aluminium up to 30 mm.

Bore Ø mm	Part number	Price in €
14	6 31 30 014 01 0	42,36
15	6 31 30 015 01 0	42,36
16	6 31 30 016 01 0	42,36
17	6 31 30 017 01 0	42,36
18	6 31 30 018 01 0	42,36
19	6 31 30 019 01 0	42,36
20	6 31 30 020 01 0	42,36
21	6 31 30 021 01 0	42,36
22	6 31 30 022 01 0	42,36
23	6 31 30 023 01 0	42,36
24	6 31 30 024 01 0	44,11
25	6 31 30 025 01 0	44,11
26	6 31 30 026 01 0	44,11
27	6 31 30 027 01 0	44,11
28	6 31 30 028 01 0	44,11
29	6 31 30 029 01 0	47,05
30	6 31 30 030 01 0	47,05

**TiAlN-coated carbide core drill**



**Carbide core drill bit with TiAlN coating and QuickIN PLUS holder**  
 Maximum service life thanks to TiAlN coating. Outstanding cutting performance in all common metals, 20% better work progress, reduced cutting and feed forces thanks to TiAlN coating. Metric dimensions, cutting depth 20 mm, drilling diameter in steel up to 25 mm, drilling diameter in aluminium up to 30 mm.

Bore Ø mm	Part number	Price in €
14	6 31 30 114 01 0	54,00
15	6 31 30 115 01 0	54,00
16	6 31 30 116 01 0	54,00
17	6 31 30 117 01 0	54,00
18	6 31 30 118 01 0	56,93
19	6 31 30 119 01 0	56,93
20	6 31 30 120 01 0	56,93
21	6 31 30 121 01 0	56,93
22	6 31 30 122 01 0	56,93
23	6 31 30 123 01 0	56,93
24	6 31 30 124 01 0	60,48
25	6 31 30 125 01 0	60,48
26	6 31 30 126 01 0	60,48
27	6 31 30 127 01 0	60,48
28	6 31 30 128 01 0	60,48
29	6 31 30 129 01 0	60,48
30	6 31 30 130 01 0	60,48

**Carbide hole saws**



**Carbide hole saw with QuickIN PLUS holder**  
 Carbide cutting tips for optimum service life for efficient drilling in sheet metal plate up to 4.0 mm thick. Metric dimensions, cutting depth 4 mm.

Bore Ø mm	Part number	Price in €
14	6 31 31 014 01 0	32,94
15	6 31 31 015 01 0	32,94
16	6 31 31 016 01 0	32,94
17	6 31 31 017 01 0	32,94
18	6 31 31 018 01 0	32,94
19	6 31 31 019 01 0	32,94
20	6 31 31 020 01 0	37,07
21	6 31 31 021 01 0	37,07
22	6 31 31 022 01 0	37,07
23	6 31 31 023 01 0	37,07
24	6 31 31 024 01 0	37,07
25	6 31 31 025 01 0	37,07
26	6 31 31 026 01 0	37,07
27	6 31 31 027 01 0	37,07
28	6 31 31 028 01 0	37,07
29	6 31 31 029 01 0	39,88
30	6 31 31 030 01 0	39,88
31	6 31 31 031 01 0	42,93
32	6 31 31 032 01 0	42,93
33	6 31 31 033 01 0	42,93
34	6 31 31 034 01 0	46,23
35	6 31 31 035 01 0	46,23
36	6 31 31 036 01 0	50,72
37	6 31 31 037 01 0	50,72
38	6 31 31 038 01 0	50,72
39	6 31 31 039 01 0	50,72
40	6 31 31 040 01 0	50,72
41	6 31 31 041 01 0	50,72
42	6 31 31 042 01 0	50,72
43	6 31 31 043 01 0	55,64
44	6 31 31 044 01 0	55,64
45	6 31 31 045 01 0	55,64
46	6 31 31 046 01 0	55,64
47	6 31 31 047 01 0	55,64
48	6 31 31 048 01 0	59,41
49	6 31 31 049 01 0	59,41
50	6 31 31 050 01 0	59,41
51	6 31 31 051 01 0	59,41
52	6 31 31 052 01 0	59,41
53	6 31 31 053 01 0	61,17
54	6 31 31 054 01 0	61,17
55	6 31 31 055 01 0	63,51
56	6 31 31 056 01 0	69,08
57	6 31 31 057 01 0	74,66
58	6 31 31 058 01 0	80,23
59	6 31 31 059 01 0	86,91
60	6 31 31 060 01 0	93,60
65	6 31 31 065 01 0	95,82
68	6 31 31 068 01 0	99,17
70	6 31 31 070 01 0	103,64
75	6 31 31 075 01 0	105,86
80	6 31 31 080 01 0	110,31



**Carbide hole saws for pipes**



**Carbide hole saw for pipes with QuickIN PLUS holder**  
Carbide cutting tips for optimum service life for use with pipe material and curved surfaces with wall thicknesses of up to 4 mm.  
Metric dimensions, cutting depth 4 mm.

Bore Ø mm	Part number	Price in €
21	6 31 31 421 01 0	41,76
22	6 31 31 422 01 0	41,76
23	6 31 31 423 01 0	41,76
24	6 31 31 424 01 0	41,76
25	6 31 31 425 01 0	41,76
26	6 31 31 426 01 0	41,76
27	6 31 31 427 01 0	41,76
28	6 31 31 428 01 0	41,76
29	6 31 31 429 01 0	44,70
30	6 31 31 430 01 0	44,70
31	6 31 31 431 01 0	50,46
32	6 31 31 432 01 0	50,46
33	6 31 31 433 01 0	50,46
34	6 31 31 434 01 0	53,42
35	6 31 31 435 01 0	53,42
36	6 31 31 436 01 0	59,88
37	6 31 31 437 01 0	59,88
38	6 31 31 438 01 0	59,88
39	6 31 31 439 01 0	59,88
40	6 31 31 440 01 0	59,88
41	6 31 31 441 01 0	68,11
42	6 31 31 442 01 0	68,11
43	6 31 31 443 01 0	68,11
44	6 31 31 444 01 0	68,11
45	6 31 31 445 01 0	68,11
46	6 31 31 446 01 0	73,98
47	6 31 31 447 01 0	73,98
48	6 31 31 448 01 0	73,98
49	6 31 31 449 01 0	73,98
50	6 31 31 450 01 0	73,98
51	6 31 31 451 01 0	76,36
52	6 31 31 452 01 0	76,36
53	6 31 31 453 01 0	76,36
54	6 31 31 454 01 0	76,36
55	6 31 31 455 01 0	78,00
56	6 31 31 456 01 0	80,23
57	6 31 31 457 01 0	83,57
58	6 31 31 458 01 0	91,37
59	6 31 31 459 01 0	95,82
60	6 31 31 460 01 0	100,29
65	6 31 31 465 01 0	109,20
68	6 31 31 468 01 0	115,88

**Centring drill bit**



**Centring drill bit**

No. in pack pcs	Part number	Price in €
1	6 31 14 038 01 0	14,54
5	6 31 14 038 02 0	65,43

**Tapping**



**Collet chuck**  
with collets 6/7/9 mm

Part number	Price in €
6 32 06 067 02 0	98,82



**Collets**  
for collets and floating collet chucks  
M2 (DIN 352, DIN 371), M4 (DIN 357, DIN 376)

Ø mm	Square mm	Part number	Price in €
2,8	2,1	6 32 06 077 00 1	22,74



**Collets**  
for collets and floating collet chucks  
M3 (DIN 352, DIN 371), M5 (DIN 357, DIN 376)

Ø mm	Square mm	Part number	Price in €
3,5	2,7	6 32 06 064 00 1	22,74



**Collets**  
for collets and floating collet chucks  
M4 (DIN 352, DIN 371), M6 (DIN 357, DIN 376)

Ø mm	Square mm	Part number	Price in €
4,5	3,4	6 32 06 065 00 5	22,74



**Collets**  
for collets and floating collet chucks  
M5 (DIN 352, DIN 371), M6 (DIN 352), M7 (DIN 352),  
M8 (DIN 352, DIN 357, DIN 376)

Ø mm	Square mm	Part number	Price in €
6	4,9	6 32 06 066 00 8	22,74



**Collets**  
for collets and floating collet chucks  
M7 (DIN 371), M9 (DIN 352) M 10 (DIN 352, DIN 357,  
DIN 376)

Ø mm	Square mm	Part number	Price in €
7	5,5	6 32 06 070 00 6	22,74



**Collets**  
for collets and floating collet chucks  
M12 (DIN 357, DIN 371, DIN 376)

Ø mm	Square mm	Part number	Price in €
9	7	6 32 06 075 00 4	22,74



**Collets**  
for collets and floating collet chucks  
M8 (DIN 371), M11 (DIN 352)

Ø mm	Square mm	Part number	Price in €
8	6,2	6 32 06 078 00 9	22,74



**Collets**  
for collets and floating collet chucks  
M10 (DIN 371)

Ø mm	Square mm	Part number	Price in €
10	8	6 32 06 079 00 3	22,09



**Jaw chuck**  
for tapping drill direct adaptor clamping range 2.8 - 9.0 mm,  
with key wrench

Part number	Price in €
6 32 06 018 01 0	102,35

Other accessories



**Swarf cup**  
Prevents contact with hot swarf with sharp edges.

Part number	Price in €
3 21 74 013 01 0	17,52



**Cutting spray**  
300 ml pump spray, for long tool life, optimum cutting performance and enhanced swarf flow.

Part number	Price in €
3 21 32 031 00 0	15,20



**Cutting paste**  
Lubricating agents for working on sheet metals.

Part number	Price in €
3 21 32 020 12 9	14,11



**Extension**  
For use on confined, deep or layered surfaces. QuickIN-PLUS holder, length 100 mm, including adapter for centring drill bit.

Part number	Price in €
6 31 06 017 01 0	70,94



**QuickIN PLUS adapter on B16**

Part number	Price in €
6 39 01 047 00 0	19,61



**QuickIN Plus adapter for 1/2" -20 UNF**

Part number	Price in €
6 39 01 054 00 0	19,61



**Key-type drill chucks**  
Drill chuck holder B 16

Chuck opening mm	Weight kg	Part number	Price in €
1.5-13	0,41	6 32 02 030 01 5	42,28



**Quick-action chucks**  
Drill chuck holder B 16  
R shaped tip with locking force safety device

Chuck opening mm	Weight kg	Part number	Price in €
1-13	0,56	6 32 04 032 00 6	80,06



**Quick-action chucks**  
Single sheath metal SUPRA SKE quick clamping drill chuck with locking force safety device, drill chuck holder 1/2-20 UNF

Chuck opening mm	Weight kg	Part number	Price in €
3-16	0,56	6 32 05 038 01 0	101,52



**Quick-action chucks**  
SUPRA SKE single-sheath metal quick-clamping drill chuck with chucking force safety device, QuickIN Plus holder

Part number	Price in €
6 39 01 054 01 0	104,35



	KBB 30	KBB 38	KBB 60	KBB 40	
	Small and extremely lightweight single-speed economical magnetic core drill with basic functionality for core drilling on the construction site.	Compact and precise single-speed economical magnetic core drill with basic functionality for core drilling in the workshop and on the construction site.	High-performance 2-speed economical magnetic core drill with basic functionality for core drilling in the workshop up to a cutting depth of 75 mm.	Extremely small single-speed compact magnetic core drill with fixed drill motor for core drilling in tight spaces in the workshop and on the construction site.	
<b>Page</b>	152	152	152	153	
<b>Application</b>	Core drilling in metal with a Ø up to 30 mm	▲▲	▲▲	▲▲	▲▲
	Core drilling in metal with a Ø up to 40 mm			▲▲	▲▲
	Core drilling in metal with a Ø up to 60 mm			▲▲	
	Working one-handed	▲▲	▲▲	▲▲	▲▲
	Working overhead	▲▲	▲▲	▲	▲▲
	Installation work	▲▲	▲▲	▲	▲▲
	Workshop jobs	▲▲	▲▲	▲▲	▲▲
<b>Technical features</b>	Carbide core drill bit max. Ø	30 mm	38 mm	60 mm	40 mm
	HSS core drill max. Ø	30 mm	38 mm	60 mm	40 mm
	Core drill, drilling depth max.	50 mm	50 mm	75 mm	50 mm
	Input	750 W	1 050 W	1 400 W	1 100 W
	Output	430 W	530 W	770 W	610 W
	Speed, no load	740 1/min	480 1/min		450 1/min
	1st gear			330 1/min	
	2nd gear			660 1/min	
	Speed, full load	430 1/min	330 1/min		280 1/min
	1st gear			180 1/min	
	2nd gear			340 1/min	
	Core drill holder	3/4" Weldon	3/4" Weldon	3/4" Weldon	3/4" Weldon
	Stroke	65 mm	65 mm	92 mm	65 mm
	Magnetic holding power	9 000 N	9 000 N	11 000 N	9 000 N
	Magnetic foot dimensions	178 x 95 mm	178 x 95 mm	191 x 102 mm	165 x 102 mm
Cable with plug	3,8 m	3,8 m	3,8 m	3,8 m	
Weight according to EPTA	10,5 kg	12,9 kg	23,9 kg	12,8 kg	

▲ suitability    ▲▲ optimal suitability

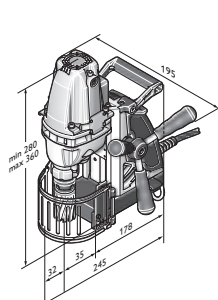

KBB 30

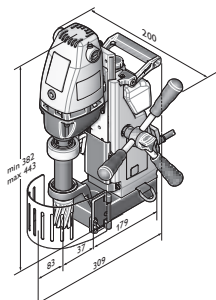

KBB 38

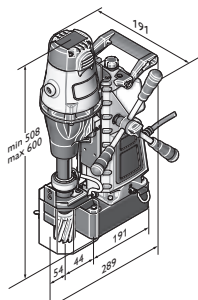

KBB 60

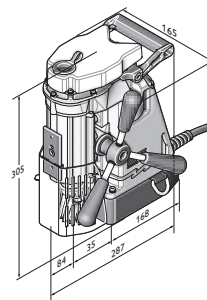

KBB 40

**KBB 30**

Small and extremely lightweight single-speed economical magnetic core drill with basic functionality for core drilling on the construction site.



For accessories, see page 154

Input	W	750
Output	W	430
Speed, full load	1/min	430
Speed, no load	1/min	740
Core drill, drilling depth max.	mm	50
Carbide core drill bit max. Ø	mm	30
HSS core drill max. Ø	mm	30
Core drill holder		3/4" Weldon
Stroke	mm	65
Magnetic holding power	N	9 000
Magnetic foot dimensions	mm	178 x 95
Cable with plug	m	3,8
Weight according to EPTA	kg	10,5
<b>Part number</b>		<b>7 272 01 61 00 0</b>
<b>EAN</b>		<b>4014586700212</b>
<b>Price in € [PC01]</b>		<b>733,95</b>

**FEIN benefits:**

- ▶ Extremely compact with perfect power-to-weight ratio for work at height and in tight spaces.
- ▶ Feed handwheel can be moved from one side to the other for use in special work situations.
- ▶ Concealed motor wiring prevents wires from snagging or getting caught on the workpiece.
- ▶ Internal cooling.
- ▶ Easy guide adjustment.

**Price includes:**

1 case, 1 coolant tank, 1 lashing strap, 1 swarf hook, 2 centering pins, 1 socket head wrench 5 mm, 1 contact guard

**KBB 38**

Compact and precise single-speed economical magnetic core drill with basic functionality for core drilling in the workshop and on the construction site.



For accessories, see page 154

Input	W	1 050
Output	W	530
Speed, full load	1/min	330
Speed, no load	1/min	480
Core drill, drilling depth max.	mm	50
Carbide core drill bit max. Ø	mm	38
HSS core drill max. Ø	mm	38
Core drill holder		3/4" Weldon
Stroke	mm	65
Magnetic holding power	N	9 000
Magnetic foot dimensions	mm	178 x 95
Cable with plug	m	3,8
Weight according to EPTA	kg	12,9
<b>Part number</b>		<b>7 272 02 61 00 0</b>
<b>EAN</b>		<b>4014586700328</b>
<b>Price in € [PC01]</b>		<b>890,40</b>

**FEIN benefits:**

- ▶ Stable torque drill motor for challenging core drilling.
- ▶ Special drill spindle guide maintains concentricity and ensures reliable core ejection.
- ▶ Solid die-cast aluminium construction for work under adverse conditions.
- ▶ Integrated coolant tank.
- ▶ Concealed motor wiring
- ▶ Extra handle for easy transport.
- ▶ Feed handwheel can be moved from one side to the other.

**Price includes:**

1 case, 1 coolant tank, 1 lashing strap, 1 swarf hook, 2 centering pins, 1 contact guard, 1 socket head wrench 5 mm, 1 carry handle

**KBB 60**

High-performance 2-speed economical magnetic core drill with basic functionality for core drilling in the workshop up to a cutting depth of 75 mm.



For accessories, see page 154

Input	W	1 400
Output	W	770
1st gear	1/min	180
2nd gear	1/min	340
1st gear	1/min	330
2nd gear	1/min	660
Core drill, drilling depth max.	mm	75
Carbide core drill bit max. Ø	mm	60
HSS core drill max. Ø	mm	60
Core drill holder		3/4" Weldon
Stroke	mm	92
Magnetic holding power	N	11 000
Magnetic foot dimensions	mm	191 x 102
Cable with plug	m	3,8
Weight according to EPTA	kg	23,9
<b>Part number</b>		<b>7 272 04 61 00 0</b>
<b>EAN</b>		<b>4014586700410</b>
<b>Price in € [PC01]</b>		<b>1.720,95</b>

**FEIN benefits:**

- ▶ Stable torque drill motor for challenging core drilling.
- ▶ Special drill spindle guide maintains concentricity and ensures reliable core ejection.
- ▶ Solid die-cast aluminium construction for work under adverse conditions.
- ▶ Integrated coolant tank.
- ▶ Concealed motor wiring
- ▶ Extra handle for easy transport.
- ▶ Feed handwheel can be moved from one side to the other.
- ▶ Mechanical 2-speed gearbox.
- ▶ Extra-long drill shaft for 75 mm cutting depth.

**Price includes:**

1 case, 1 coolant tank, 1 lashing strap, 1 swarf hook, 2 centering pins, 1 contact guard, 1 socket head wrench 5 mm, 1 carry handle

**KBB 40**

Extremely small single-speed compact magnetic core drill with fixed drill motor for core drilling in tight spaces in the workshop and on the construction site.



For accessories, see page 154

Input	W	1 100
Output	W	610
Speed, full load	1/min	280
Speed, no load	1/min	450
Core drill, drilling depth max.	mm	50
Carbide core drill bit max. Ø	mm	40
HSS core drill max. Ø	mm	40
Core drill holder		3/4" Weldon
Stroke	mm	65
Magnetic holding power	N	9 000
Magnetic foot dimensions	mm	165 x 102
Cable with plug	m	3,8
Weight according to EPTA	kg	12,8
<b>Part number</b>		<b>7 272 03 61 00 0</b>
<b>EAN</b>		<b>4014586700502</b>
<b>Price in € [PC01]</b>		<b>1.203,30</b>

**FEIN benefits:**

- ▶ Extremely compact with perfect power-to-weight ratio for work at height and in tight spaces.
- ▶ Feed handwheel can be moved from one side to the other for use in special work situations.
- ▶ Concealed motor wiring prevents wires from snagging or getting caught on the workpiece.
- ▶ Easy guide adjustment.
- ▶ Fixed drill motor.
- ▶ Internal cooling.
- ▶ Solid die-cast aluminium construction.

**Price includes:**

1 case, 1 coolant tank, 1 lashing strap, 1 swarf hook, 2 centering pins, 1 contact guard, 1 socket head wrench 5 mm

**Best of core drilling HSS accessory set**



**Best of core bits 3/4" Weldon**  
Industrial standard. Metric dimensions, cutting depth 25 mm.  
Set version, consisting of 4 core bits, 2x 14 mm diameter,  
2x 18 mm diameter, (cutting depth 25 mm) and 1 centring pin  
(80 mm) in plastic case.

Part number	Price in €
6 31 34 999 06 2	83,57



**Best of core bits 3/4" Weldon**  
Industrial standard. Metric dimensions, cutting depth 50 mm.  
Set version, consisting of 4 core bits, 2x 14 mm diameter,  
2x 18 mm diameter, (cutting depth 50 mm) and 1 centring pin  
(105 mm) in plastic case.

Part number	Price in €
6 31 34 999 06 4	110,31



**Best of core bits 3/4" Weldon**  
Industrial standard. Metric dimensions, cutting depth 25 mm.  
Set version, consisting of 6 core bits with diameters of 12, 14,  
16, 18, 20 and 22 mm (cutting depth 25 mm) and 2 centring pins  
(80 mm) in plastic case.

Part number	Price in €
6 31 34 999 06 1	132,60



**Best of core bits 3/4" Weldon**  
Industrial standard. Metric dimensions, cutting depth 50 mm.  
Set version, consisting of 6 core bits with diameters of 12, 14,  
16, 18, 20 and 22 mm (cutting depth 50 mm) and 2 centring pins  
(105 mm) in plastic case.

Part number	Price in €
6 31 34 999 06 3	166,03

**Best of core drilling carbide accessory set**



**Best of core bits 3/4" Weldon**  
Very long service life and outstanding cutting performance.  
Metric dimensions, cutting depth 35 mm.  
Set version, consisting of 6 core bits with diameters of 12, 14,  
16, 18, 20 and 22 mm (cutting depth 35 mm) and 2 centring pins  
(105 mm) in plastic case.

Part number	Price in €
6 31 27 714 02 0	221,74

**HSS core drill**



**HSS Nova 25 core bit with 3/4" Weldon holder**  
Industrial standard. Metric dimensions, cutting depth 25 mm.

Bore Ø mm	Part number	Price in €
12	6 31 34 120 05 1	18,26
13	6 31 34 130 05 1	18,26
14	6 31 34 140 05 1	18,26
15	6 31 34 150 05 1	18,26
16	6 31 34 160 05 1	18,26
17	6 31 34 170 05 1	19,92
18	6 31 34 180 05 1	19,92
19	6 31 34 190 05 1	19,92
20	6 31 34 200 05 1	23,25
21	6 31 34 210 05 1	23,25
22	6 31 34 220 05 1	23,25
23	6 31 34 230 05 1	26,58
24	6 31 34 240 05 1	26,58

25	6 31 34 250 05 1	26,58
26	6 31 34 260 05 1	31,00
27	6 31 34 270 05 1	31,00
28	6 31 34 280 05 1	33,21
29	6 31 34 290 05 1	33,21
30	6 31 34 300 05 1	35,43
31	6 31 34 310 05 1	35,43
32	6 31 34 320 05 1	40,95
33	6 31 34 330 05 1	40,95
34	6 31 34 340 05 1	46,47
35	6 31 34 350 05 1	46,47
36	6 31 34 360 05 1	46,47
37	6 31 34 370 05 1	54,22
38	6 31 34 380 05 1	54,22
39	6 31 34 390 05 1	54,22
40	6 31 34 400 05 1	60,87
41	6 31 34 410 05 1	60,87
42	6 31 34 420 05 1	66,40
43	6 31 34 430 05 1	66,40
44	6 31 34 440 05 1	69,73
45	6 31 34 450 05 1	69,73
46	6 31 34 460 05 1	79,70
47	6 31 34 470 05 1	79,70
48	6 31 34 480 05 1	83,00
49	6 31 34 490 05 1	83,00
50	6 31 34 500 05 1	83,00
51	6 31 34 510 05 1	88,54
52	6 31 34 520 05 1	88,54
53	6 31 34 530 05 1	94,08
54	6 31 34 540 05 1	94,08
55	6 31 34 550 05 1	102,92
56	6 31 34 560 05 1	117,32
57	6 31 34 570 05 1	117,32
58	6 31 34 580 05 1	126,17
59	6 31 34 590 05 1	126,17
60	6 31 34 600 05 1	126,17



**HSS Nova 50 core bit with 3/4" Weldon holder**  
Industrial standard. Metric dimensions, cutting depth 50 mm.

Bore Ø mm	Part number	Price in €
12	6 31 34 120 05 2	25,63
13	6 31 34 130 05 2	25,63
14	6 31 34 140 05 2	25,63
15	6 31 34 150 05 2	25,63
16	6 31 34 160 05 2	25,63
17	6 31 34 170 05 2	27,95
18	6 31 34 180 05 2	27,95
19	6 31 34 190 05 2	27,95
20	6 31 34 200 05 2	32,62
21	6 31 34 210 05 2	32,62
22	6 31 34 220 05 2	32,62
23	6 31 34 230 05 2	32,62
24	6 31 34 240 05 2	34,95
25	6 31 34 250 05 2	39,62
26	6 31 34 260 05 2	39,62
27	6 31 34 270 05 2	39,62
28	6 31 34 280 05 2	46,60
29	6 31 34 290 05 2	46,60
30	6 31 34 300 05 2	46,60
31	6 31 34 310 05 2	52,43
32	6 31 34 320 05 2	52,43
33	6 31 34 330 05 2	58,26
34	6 31 34 340 05 2	58,26
35	6 31 34 350 05 2	58,26
36	6 31 34 360 05 2	66,40
37	6 31 34 370 05 2	66,40





38	6 31 34 380 05 2	66,40
39	6 31 34 390 05 2	75,73
40	6 31 34 400 05 2	75,73
41	6 31 34 410 05 2	81,54
42	6 31 34 420 05 2	88,54
43	6 31 34 430 05 2	88,54
44	6 31 34 440 05 2	88,54
45	6 31 34 450 05 2	93,20
46	6 31 34 460 05 2	102,51
47	6 31 34 470 05 2	102,51
48	6 31 34 480 05 2	107,17
49	6 31 34 490 05 2	107,17
50	6 31 34 500 05 2	110,68
51	6 31 34 510 05 2	122,33
52	6 31 34 520 05 2	122,33
53	6 31 34 530 05 2	122,33
54	6 31 34 540 05 2	128,15
55	6 31 34 550 05 2	128,15
56	6 31 34 560 05 2	133,96
57	6 31 34 570 05 2	133,96
58	6 31 34 580 05 2	143,29
59	6 31 34 590 05 2	143,29
60	6 31 34 600 05 2	143,29



**HSS Nova 75 core bit with 3/4" Weldon holder**  
Industrial standard. Metric dimensions, cutting depth 75 mm.

Bore Ø mm	Part number	Price in €
19	6 31 34 190 05 3	60,01
20	6 31 34 200 05 3	60,01
21	6 31 34 210 05 3	64,80
22	6 31 34 220 05 3	64,80
23	6 31 34 230 05 3	64,80
24	6 31 34 240 05 3	64,80
25	6 31 34 250 05 3	75,60
26	6 31 34 260 05 3	75,60
27	6 31 34 270 05 3	75,60
28	6 31 34 280 05 3	84,01
29	6 31 34 290 05 3	84,01
30	6 31 34 300 05 3	97,20
32	6 31 34 320 05 3	97,20
35	6 31 34 350 05 3	104,39
36	6 31 34 360 05 3	112,80
40	6 31 34 400 05 3	138,00
45	6 31 34 450 05 3	143,99
50	6 31 34 500 05 3	161,99
60	6 31 34 600 05 3	197,99



**HSS DURA 25 core bit with 3/4" Weldon holder**  
TiN surface coating for outstanding service lives and the best  
glide properties.  
Metric dimensions, cutting depth 25 mm.

Bore Ø mm	Part number	Price in €
12	6 31 34 120 07 5	26,90
13	6 31 34 130 07 5	26,90
14	6 31 34 140 07 5	26,90
15	6 31 34 150 07 5	26,90
16	6 31 34 160 07 5	26,90
17	6 31 34 170 07 5	29,36
18	6 31 34 180 07 5	29,36
19	6 31 34 190 07 5	29,36
20	6 31 34 200 07 5	33,02
21	6 31 34 210 07 5	33,02
22	6 31 34 220 07 5	33,02
23	6 31 34 230 07 5	40,36
24	6 31 34 240 07 5	40,36
25	6 31 34 250 07 5	40,36
26	6 31 34 260 07 5	44,04
27	6 31 34 270 07 5	44,04
28	6 31 34 280 07 5	47,70
29	6 31 34 290 07 5	47,70
30	6 31 34 300 07 5	52,59
31	6 31 34 310 07 5	52,59
32	6 31 34 320 07 5	59,94
33	6 31 34 330 07 5	59,94
34	6 31 34 340 07 5	66,06
35	6 31 34 350 07 5	66,06
36	6 31 34 360 07 5	66,06
37	6 31 34 370 07 5	74,62
38	6 31 34 380 07 5	74,62
39	6 31 34 390 07 5	74,62
40	6 31 34 400 07 5	83,16
41	6 31 34 410 07 5	83,16
42	6 31 34 420 07 5	90,52
43	6 31 34 430 07 5	90,52
44	6 31 34 440 07 5	96,62
45	6 31 34 450 07 5	96,62
46	6 31 34 460 07 5	107,64
47	6 31 34 470 07 5	107,64
48	6 31 34 480 07 5	117,43
49	6 31 34 490 07 5	117,43
50	6 31 34 500 07 5	117,43
51	6 31 34 510 07 5	124,76
52	6 31 34 520 07 5	124,76
53	6 31 34 530 07 5	130,88
54	6 31 34 540 07 5	130,88
55	6 31 34 550 07 5	134,56
56	6 31 34 560 07 5	140,67
57	6 31 34 570 07 5	140,67
58	6 31 34 580 07 5	152,90
59	6 31 34 590 07 5	152,90
60	6 31 34 600 07 5	152,90



**HSS DURA 50 core bit with 3/4" Weldon holder**

TiN surface coating for outstanding service lives and the best glide properties.  
Metric dimensions, cutting depth 50 mm.

Bore Ø mm	Part number	Price in €
12	6 31 34 120 07 6	34,24
13	6 31 34 130 07 6	34,24
14	6 31 34 140 07 6	34,24
15	6 31 34 150 07 6	34,24
16	6 31 34 160 07 6	34,24
17	6 31 34 170 07 6	36,71
18	6 31 34 180 07 6	36,71
19	6 31 34 190 07 6	36,71
20	6 31 34 200 07 6	41,60
21	6 31 34 210 07 6	41,60
22	6 31 34 220 07 6	41,60
23	6 31 34 230 07 6	48,93
24	6 31 34 240 07 6	48,93
25	6 31 34 250 07 6	48,93
26	6 31 34 260 07 6	55,05
27	6 31 34 270 07 6	55,05
28	6 31 34 280 07 6	59,94
29	6 31 34 290 07 6	59,94
30	6 31 34 300 07 6	66,06
31	6 31 34 310 07 6	66,06
32	6 31 34 320 07 6	74,62
33	6 31 34 330 07 6	74,62
34	6 31 34 340 07 6	83,16
35	6 31 34 350 07 6	83,16
36	6 31 34 360 07 6	83,16
37	6 31 34 370 07 6	92,97
38	6 31 34 380 07 6	92,97
39	6 31 34 390 07 6	92,97
40	6 31 34 400 07 6	103,97
41	6 31 34 410 07 6	103,97
42	6 31 34 420 07 6	113,75
43	6 31 34 430 07 6	113,75
44	6 31 34 440 07 6	122,33
45	6 31 34 450 07 6	122,33
46	6 31 34 460 07 6	137,01
47	6 31 34 470 07 6	137,01
48	6 31 34 480 07 6	146,78
49	6 31 34 490 07 6	146,78
50	6 31 34 500 07 6	146,78
51	6 31 34 510 07 6	156,57
52	6 31 34 520 07 6	156,57
53	6 31 34 530 07 6	165,12
54	6 31 34 540 07 6	165,12
55	6 31 34 550 07 6	168,80
56	6 31 34 560 07 6	176,14
57	6 31 34 570 07 6	176,14
58	6 31 34 580 07 6	190,83
59	6 31 34 590 07 6	190,83
60	6 31 34 600 07 6	190,83

**Carbide core drill**



**TCT Ultra 35 core bit with 3/4" Weldon holder**

Very long service life and outstanding cutting performance.  
Metric dimensions, cutting depth 35 mm.

Bore Ø mm	Part number	Price in €
12	6 31 27 714 01 0	45,75
13	6 31 27 715 01 0	45,75
14	6 31 27 716 01 0	45,75
15	6 31 27 717 01 0	45,75
16	6 31 27 718 01 0	45,75
17	6 31 27 719 01 0	45,75
18	6 31 27 720 01 0	45,75
19	6 31 27 721 01 0	45,75
20	6 31 27 722 01 0	45,75
21	6 31 27 723 01 0	45,75
22	6 31 27 724 01 0	45,75
23	6 31 27 725 01 0	45,75
24	6 31 27 726 01 0	45,75
25	6 31 27 727 01 0	45,75
26	6 31 27 728 01 0	45,75
27	6 31 27 729 01 0	45,75
28	6 31 27 730 01 0	45,75
29	6 31 27 731 01 0	52,65
30	6 31 27 732 01 0	52,65
31	6 31 27 733 01 0	52,65
32	6 31 27 734 01 0	52,65
33	6 31 27 735 01 0	52,65
34	6 31 27 736 01 0	52,65
35	6 31 27 737 01 0	52,65
36	6 31 27 738 01 0	60,94
37	6 31 27 739 01 0	60,94
38	6 31 27 740 01 0	60,94
39	6 31 27 741 01 0	60,94
40	6 31 27 742 01 0	60,94
41	6 31 27 743 01 0	72,03
42	6 31 27 744 01 0	72,03
43	6 31 27 745 01 0	72,03
44	6 31 27 746 01 0	72,03
45	6 31 27 747 01 0	72,03
46	6 31 27 748 01 0	80,36
47	6 31 27 749 01 0	80,36
48	6 31 27 750 01 0	80,36
49	6 31 27 751 01 0	80,36
50	6 31 27 752 01 0	80,36
51	6 31 27 753 01 0	88,78
52	6 31 27 754 01 0	88,78
53	6 31 27 755 01 0	88,78
54	6 31 27 756 01 0	88,78
55	6 31 27 757 01 0	88,78
56	6 31 27 758 01 0	92,61
57	6 31 27 759 01 0	92,61
58	6 31 27 760 01 0	92,61
59	6 31 27 761 01 0	92,61
60	6 31 27 762 01 0	92,61



**Centering pins**

Centering pins		
L mm	Part number	Price in €
80	3 02 17 359 00 0	13,32
100	3 02 17 358 00 0	13,32
125	3 02 17 333 00 3	13,73

**Clamping fixtures**



**Vacuum plate**  
for anti-magnetic materials and structured bases (corrugated sheet, stud plate etc.)  
Vacuum plate 396 x 200 x 95 mm

Part number	Price in €
9 26 02 057 01 7	484,09



**Vacuum pump**  
Suction rate 0,015 m<sup>3</sup>/min, -0,8 bar, 92 W, weight 2,5 kg including suction hose

Part number	Price in €
9 26 01 022 01 3	499,09



**Suction plate**  
for anti-magnetic materials, 250 x 330 x 110 mm

Part number	Price in €
9 26 02 054 01 6	465,89



**Pipe drilling device**  
incl. clamping strap, for positioning bores on pipes with pipe Ø of 60 to 300 mm, 220 x 130 mm.

Part number	Price in €
9 26 02 055 01 0	253,83

**Cooling**



**Pump**  
Capacity approx. 450 ml. Suited to FEIN core drilling units KBM 32 Q, KBM 50 QX, KBM 52 U, KBM 65 Q, KBM 65 QF.

Part number	Price in €
3 21 32 022 00 7	9,59

**Replacement hose**  
for hand pump 3 21 32 022 00 7.

Part number	Price in €
3 14 14 054 00 8	3,14



**Flex-jointed hose**  
Suitable for KBM 50 Q, 50 U, 50 auto, 65 U when using twist drills.

Part number	Price in €
3 14 14 070 01 0	12,62



**Cutting spray**  
300 ml pump spray, for long tool life, optimum cutting performance and enhanced swarf flow.

Part number	Price in €
3 21 32 031 00 0	15,20



**Cutting paste**  
Lubricating agents for working on sheet metals.

Part number	Price in €
3 21 32 020 12 9	14,11

**Other accessories**



**Magbrush**  
Practical tool with high magnetic force for quick and easy collection of magnetic metal swarf.

Part number	Price in €
6 42 01 005 01 0	42,61



	KBU 35 Q	KBU 35 QW	KBU 35-2 Q	KBU 35-2 QW	
	Small and powerful single-speed universal magnetic core drill with clockwise/anti-clockwise operation and maximum functionality for flexible working on the construction site.		Small and powerful 2-speed universal magnetic core drill with clockwise/anti-clockwise operation and high speed for efficient twist drilling on the construction site.		
<b>Page</b>	160	160	161	161	
<b>Application</b>	Core drilling in metal with a Ø up to 32 mm	▲▲	▲▲	▲▲	▲▲
	Core drilling in metal with a Ø up to 50 mm				
	Core drilling in metal with a Ø up to 65 mm				
	Core drilling in metal with a Ø up to 80 mm				
	Twist drills with drill chuck (DIN 338)	▲	▲	▲▲	▲▲
	Twist drills with MK fitting (DIN 345)				
	Tapping	▲▲	▲▲	▲▲	▲▲
	Countersinking	▲▲	▲▲	▲▲	▲▲
	Reaming	▲▲	▲▲	▲▲	▲▲
	Working one-handed	▲▲	▲▲	▲▲	▲▲
Working overhead	▲▲	▲▲	▲▲	▲▲	
Installation work	▲▲	▲▲	▲▲	▲▲	
Workshop jobs	▲▲	▲▲	▲▲	▲▲	
<b>Equipment</b>	Electronic magnetic holding force				
	Magnetic holding force display	●	●	●	●
	Reversible rotation	●	●	●	●
	Variable speed control	●	●	●	●
	Memory function	●	●	●	●
	Speed-controlled electronics (tacho)	●	●	●	●
	Torque slipping clutch				
<b>Technical features</b>	Carbide core drill bit max. Ø	35 mm	35 mm	35 mm	35 mm
	HSS core drill max. Ø	35 mm	35 mm	35 mm	35 mm
	Core drill, drilling depth max.	50 mm	50 mm	50 mm	50 mm
	Twist drill max. Ø	16 mm	16 mm	16 mm	16 mm
	Tapping	M 14	M 14	M 14	M 14
	Countersinking max. Ø	31 mm	31 mm	31 mm	31 mm
	Reaming max. Ø	16 mm	16 mm	16 mm	16 mm
	Input	1 100 W	1 100 W	1 100 W	1 100 W
	Output	550 W	550 W	550 W	550 W
	Speed, full load	130 - 520 1/min	130 - 520 1/min		
	1st gear			130 - 520 1/min	130 - 520 1/min
	2nd gear			400 - 1 600 1/min	400 - 1 600 1/min
	3rd gear				
	Core drill holder	QuickIN	3/4" Weldon	QuickIN	3/4" Weldon
	Tool Holder				
	Stroke	135 mm	135 mm	135 mm	135 mm
	Total stroke range	260 mm	260 mm	260 mm	260 mm
	Adjustment range for drill jigs				
	Swivel range for drill jigs				
Magnetic holding power	10 000 N	10 000 N	9 500 N	9 500 N	
Magnetic foot dimensions	175 x 80 mm	175 x 80 mm	186 x 70 mm	187 x 70 mm	
Cable with plug	4 m	4 m	4 m	4 m	
Weight according to EPTA	10,6 kg	10,6 kg	11 kg	11 kg	

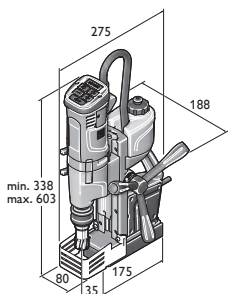

KBU 35 Q  
KBU 35 QW

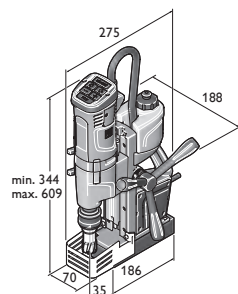

KBU 35-2 Q  
KBU 35-2 QW

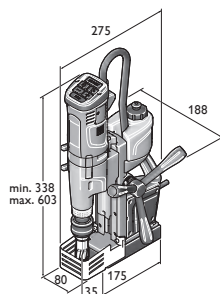

KBU 35 MQ  
KBU 35 MQW

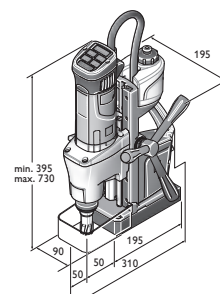

KBM 50 Q



	KBU 35 MQ	KBU 35 MQW	KBM 50 Q	KBM 50 U	KBM 65 U	KBM 80 U
	Small and powerful single-speed universal magnetic core drill with clockwise/anti-clockwise operation, MT2 tool mounting and maximum functionality for flexible working on the construction site.		Lightweight and powerful 2-speed universal magnetic core drill with clockwise/anti-clockwise operation and maximum functionality for flexible working in the workshop and on the construction site.	Lightweight and powerful 2-speed universal magnetic core drill with clockwise/anti-clockwise operation, MT3 tool mounting and maximum functionality for flexible working in the workshop and on the construction site.	Powerful and very high-performance 2-speed universal magnetic core drill with clockwise/anti-clockwise operation, MT3 tool mounting, fine adjustment and maximum functionality for flexible working in the workshop.	Powerful and very high-performance 3-speed universal magnetic core drill with clockwise/anti-clockwise operation, MT3 tool mounting, fine adjustment and maximum functionality for flexible working in the workshop.
	162	162	163	163	164	164
	▲▲	▲▲	▲▲	▲▲	▲▲	▲▲
					▲▲	▲▲
	▲	▲	▲	▲	▲	▲
	▲▲	▲▲		▲▲	▲▲	▲▲
	▲▲	▲▲	▲▲	▲▲	▲▲	▲▲
	▲▲	▲▲	▲▲	▲▲	▲▲	▲▲
	▲▲	▲▲	▲▲	▲▲	▲▲	▲▲
	▲▲	▲▲	▲▲	▲▲	▲▲	▲▲
	▲▲	▲▲	▲▲	▲▲	▲▲	▲▲
	●	●	●	●	●	●
	●	●	●	●	●	●
	●	●	●	●	●	●
	●	●	●	●	●	●
	●	●	●	●	●	●
	35 mm	35 mm	50 mm	50 mm	65 mm	80 mm
	35 mm	35 mm	40 mm	40 mm	45 mm	65 mm
	50(75)* mm	50(75)* mm	50 mm	50(75)* mm	50(75)* mm	50 mm
	18 mm	18 mm	16 mm	23 mm	25 mm	32 mm
	M 14	M 14	M 16	M 16	M 20	
	31 mm	31 mm	31 mm	50 mm	50 mm	50 mm
	18 mm	18 mm	16 mm	23 mm	25 mm	31 mm
	1 100 W	1 100 W	1 200 W	1 200 W	1 300 W	2 000 W
	550 W	550 W	640 W	610 W	730 W	900 W
	260 - 520 1/min	260 - 520 1/min				
			130 - 260 1/min	130 - 260 1/min	120 - 240 1/min	110 - 180 1/min
			260 - 520 1/min	260 - 520 1/min	260 - 520 1/min	160 - 260 1/min
						350 - 580 1/min
	QuickIN	3/4" Weldon	QuickIN	QuickIN	QuickIN	QuickIN
	MT 2	MT 2		MK 3	MK 3	MK 3
	135 mm	135 mm	145 mm	145 mm	145 mm	145 mm
	260 mm	260 mm	315 mm	315 mm	315 mm	285 mm
					± 6 mm	± 4,25 mm
					± 7°	± 11°
	10 000 N	10 000 N	12 500 N	12 500 N	14 000 N	18 000 N
	175 x 80 mm	175 x 80 mm	195 x 90 mm	195 x 90 mm	205 x 95 mm	270 x 90 mm
	4 m	4 m	4 m	4 m	4 m	4 m
	11 kg	11 kg	13,2 kg	13,9 kg	16,1 kg	25,4 kg

Metal core drilling

- ▲ suitability
- ▲▲ optimal suitability
- included
- \* Also available with accessories.

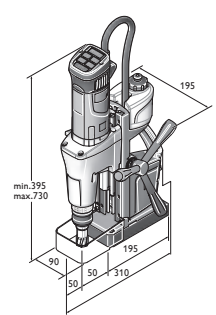

KBM 50 U

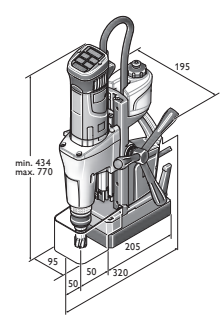

KBM 65 U

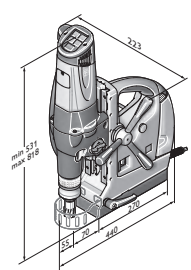

KBM 80 U

**KBU 35 Q**

Small and powerful single-speed universal magnetic core drill with clockwise/anti-clockwise operation and maximum functionality for flexible working on the construction site.



For accessories, see page 165

Input	W	1 100
Output	W	550
Speed, full load	1/min	130 - 520
Twist drill max. Ø	mm	16
Core drill, drilling depth max.	mm	50
Tapping		M 14
Countersinking max. Ø	mm	31
Reaming max. Ø	mm	16
Carbide core drill bit max. Ø	mm	35
HSS core drill max. Ø	mm	35
Core drill holder		QuickIN
Changing the core bit		tool-free
Stroke	mm	135
Total stroke range	mm	260
Magnetic holding power	N	10 000
Magnetic foot dimensions	mm	175 x 80
Cable with plug	m	4
Weight according to EPTA	kg	10,6
<b>Part number</b>		<b>7 270 53 61 00 0</b>
<b>EAN</b>		<b>4014586886039</b>
<b>Price in € [PC01]</b>		<b>1.048,95</b>

**FEIN benefits:**

- ▶ Extremely resilient construction thanks to sturdy machine design with swivel-mounted motor cable protection hose. Designed for tough use in industry and manual trades.
- ▶ Perfect power-to-weight ratio thanks to compact, weight-optimised design and FEIN 1 100 W high-power motor with high speed stability for reliable and economical working.
- ▶ With clockwise/anti-clockwise operation, electronic speed setting and a 260 mm stroke range, this is a universal tool for core drilling, twist drilling, tapping, countersinking and reaming.
- ▶ Small and lightweight.
- ▶ Simple operating concept avoids mix-ups and can be clearly seen by the user.
- ▶ Additional magnetic switch in the drill jig.
- ▶ Tool-free core bit quick change system.
- ▶ Speed-controlled tacho electronics.
- ▶ High magnetic holding force.
- ▶ Convenient magnetic holding force display.
- ▶ Integrated coolant tank.
- ▶ Feed handwheel can be moved from one side to the other.
- ▶ Tilt sensor.
- ▶ Speed saving “memory function”.

**Price includes:**

- 1 case, 1 coolant tank, 1 lashing strap, 1 swarf hook, 1 centering pin, 1 contact guard

**KBU 35 QW**

Small and powerful single-speed universal magnetic core drill with clockwise/anti-clockwise operation and maximum functionality for flexible working on the construction site.



For accessories, see page 165

Input	W	1 100
Output	W	550
Speed, full load	1/min	130 - 520
Twist drill max. Ø	mm	16
Core drill, drilling depth max.	mm	50
Tapping		M 14
Countersinking max. Ø	mm	31
Reaming max. Ø	mm	16
Carbide core drill bit max. Ø	mm	35
HSS core drill max. Ø	mm	35
Core drill holder		3/4" Weldon
Changing the core bit		tool-free
Stroke	mm	135
Total stroke range	mm	260
Magnetic holding power	N	10 000
Magnetic foot dimensions	mm	175 x 80
Cable with plug	m	4
Weight according to EPTA	kg	10,6
<b>Part number</b>		<b>7 270 54 61 00 0</b>
<b>EAN</b>		<b>4014586886763</b>
<b>Price in € [PC01]</b>		<b>1.048,95</b>

**FEIN benefits:**

- ▶ Extremely resilient construction thanks to sturdy machine design with swivel-mounted motor cable protection hose. Designed for tough use in industry and manual trades.
- ▶ Perfect power-to-weight ratio thanks to compact, weight-optimised design and FEIN 1 100 W high-power motor with high speed stability for reliable and economical working.
- ▶ With clockwise/anti-clockwise operation, electronic speed setting and a 260 mm stroke range, this is a universal tool for core drilling, twist drilling, tapping, countersinking and reaming.
- ▶ Small and lightweight.
- ▶ Simple operating concept avoids mix-ups and can be clearly seen by the user.
- ▶ Additional magnetic switch in the drill jig.
- ▶ Tool-free core bit quick change system.
- ▶ Speed-controlled tacho electronics.
- ▶ High magnetic holding force.
- ▶ Convenient magnetic holding force display.
- ▶ Integrated coolant tank.
- ▶ Feed handwheel can be moved from one side to the other.
- ▶ Tilt sensor.
- ▶ Speed saving “memory function”.

**Price includes:**

- 1 case, 1 coolant tank, 1 lashing strap, 1 swarf hook, 1 centering pin, 1 contact guard



**KBU 35-2 Q**

Small and powerful 2-speed universal magnetic core drill with clockwise/anti-clockwise operation and high speed for efficient twist drilling on the construction site.



For accessories, see page 165

Input	W	1 100
Output	W	550
1st gear	1/min	130 - 520
2nd gear	1/min	400 - 1 600
Twist drill max. Ø	mm	16
Core drill, drilling depth max.	mm	50
Tapping		M 14
Countersinking max. Ø	mm	31
Reaming max. Ø	mm	16
Carbide core drill bit max. Ø	mm	35
HSS core drill max. Ø	mm	35
Core drill holder		QuickIN
Changing the core bit		tool-free
Stroke	mm	135
Total stroke range	mm	260
Magnetic holding power	N	9 500
Magnetic foot dimensions	mm	186 x 70
Cable with plug	m	4
Weight according to EPTA	kg	11
<b>Part number</b>		<b>7 270 57 61 00 0</b>
<b>EAN</b>		<b>4014586886077</b>
<b>Price in € [PC01]</b>		<b>1.311,45</b>

**FEIN benefits:**

- ▶ Extremely resilient construction thanks to sturdy machine design with swivel-mounted motor cable protection hose. Designed for tough use in industry and manual trades.
- ▶ Perfect power-to-weight ratio thanks to compact, weight-optimised design and FEIN 1 100 W high-power motor with high speed stability for reliable and economical working.
- ▶ With clockwise/anti-clockwise operation, electronic speed setting and a 260 mm stroke range, this is a universal tool for core drilling, twist drilling, tapping, countersinking and reaming.
- ▶ Small with mechanical 2-speed gearbox for twist drilling.
- ▶ 3-coil magnet, just 70 mm wide.
- ▶ Simple operating concept avoids mix-ups and can be clearly seen by the user.
- ▶ Additional magnetic switch in the drill jig.
- ▶ Tool-free core bit quick change system.
- ▶ Speed-controlled tacho electronics.
- ▶ High magnetic holding force.
- ▶ Convenient magnetic holding force display.
- ▶ Integrated coolant tank.
- ▶ Feed handwheel can be moved from one side to the other.
- ▶ Tilt sensor.
- ▶ Speed saving "memory function".

**Price includes:**

- 1 case, 1 coolant tank, 1 lashing strap, 1 swarf hook, 1 centering pin, 1 contact guard

**KBU 35-2 QW**

Small and powerful 2-speed universal magnetic core drill with clockwise/anti-clockwise operation and high speed for efficient twist drilling on the construction site.



For accessories, see page 165

Input	W	1 100
Output	W	550
1st gear	1/min	130 - 520
2nd gear	1/min	400 - 1 600
Twist drill max. Ø	mm	16
Core drill, drilling depth max.	mm	50
Tapping		M 14
Countersinking max. Ø	mm	31
Reaming max. Ø	mm	16
Carbide core drill bit max. Ø	mm	35
HSS core drill max. Ø	mm	35
Core drill holder		3/4" Weldon
Changing the core bit		tool-free
Stroke	mm	135
Total stroke range	mm	260
Magnetic holding power	N	9 500
Magnetic foot dimensions	mm	187 x 70
Cable with plug	m	4
Weight according to EPTA	kg	11
<b>Part number</b>		<b>7 270 58 61 00 0</b>
<b>EAN</b>		<b>4014586886787</b>
<b>Price in € [PC01]</b>		<b>1.311,45</b>

**FEIN benefits:**

- ▶ Extremely resilient construction thanks to sturdy machine design with swivel-mounted motor cable protection hose. Designed for tough use in industry and manual trades.
- ▶ Perfect power-to-weight ratio thanks to compact, weight-optimised design and FEIN 1 100 W high-power motor with high speed stability for reliable and economical working.
- ▶ With clockwise/anti-clockwise operation, electronic speed setting and a 260 mm stroke range, this is a universal tool for core drilling, twist drilling, tapping, countersinking and reaming.
- ▶ Small with mechanical 2-speed gearbox for twist drilling.
- ▶ 3-coil magnet, just 70 mm wide.
- ▶ Simple operating concept avoids mix-ups and can be clearly seen by the user.
- ▶ Additional magnetic switch in the drill jig.
- ▶ Tool-free core bit quick change system.
- ▶ Speed-controlled tacho electronics.
- ▶ High magnetic holding force.
- ▶ Convenient magnetic holding force display.
- ▶ Integrated coolant tank.
- ▶ Feed handwheel can be moved from one side to the other.
- ▶ Tilt sensor.
- ▶ Speed saving "memory function".

**Price includes:**

- 1 case, 1 coolant tank, 1 lashing strap, 1 swarf hook, 1 centering pin, 1 contact guard



**KBU 35 MQ**

Small and powerful single-speed universal magnetic core drill with clockwise/anti-clockwise operation, MT2 tool mounting and maximum functionality for flexible working on the construction site.



For accessories, see page 165

Input	W	1 100
Output	W	550
Speed, full load	1/min	260 - 520
Tool Holder		MT 2
Twist drill max. Ø	mm	18
Core drill, drilling depth max.	mm	50(75)*
Tapping		M 14
Countersinking max. Ø	mm	31
Reaming max. Ø	mm	18
Carbide core drill bit max. Ø	mm	35
HSS core drill max. Ø	mm	35
Core drill holder		QuickIN
Changing the core bit		tool-free
Stroke	mm	135
Total stroke range	mm	260
Magnetic holding power	N	10 000
Magnetic foot dimensions	mm	175 x 80
Cable with plug	m	4
Weight according to EPTA	kg	11
<b>Part number</b>		<b>7 270 55 61 00 0</b>
<b>EAN</b>		<b>4014586886053</b>
<b>Price in € [PC01]</b>		<b>1.153,95</b>

**FEIN benefits:**

- ▶ Extremely resilient construction thanks to sturdy machine design with swivel-mounted motor cable protection hose. Designed for tough use in industry and manual trades.
- ▶ Perfect power-to-weight ratio thanks to compact, weight-optimised design and FEIN 1 100 W high-power motor with high speed stability for reliable and economical working.
- ▶ With clockwise/anti-clockwise operation, electronic speed setting and a 260 mm stroke range, this is a universal tool for core drilling, twist drilling, tapping, countersinking and reaming.
- ▶ Small with MT2 tool mounting.
- ▶ Simple operating concept avoids mix-ups and can be clearly seen by the user.
- ▶ Additional magnetic switch in the drill jig.
- ▶ Tool-free core bit quick change system.
- ▶ Speed-controlled tacho electronics.
- ▶ High magnetic holding force.
- ▶ Convenient magnetic holding force display.
- ▶ Integrated coolant tank.
- ▶ Feed handwheel can be moved from one side to the other.
- ▶ Tilt sensor.
- ▶ Speed saving "memory function".
- ▶ \* Also available with accessories.

**Price includes:**

- 1 case, 1 coolant tank, 1 lashing strap, 1 swarf hook, 1 centering pin, 1 contact guard, 1 drift key

**KBU 35 MQW**

Small and powerful single-speed universal magnetic core drill with clockwise/anti-clockwise operation, MT2 tool mounting and maximum functionality for flexible working on the construction site.



For accessories, see page 165

Input	W	1 100
Output	W	550
Speed, full load	1/min	260 - 520
Tool Holder		MT 2
Twist drill max. Ø	mm	18
Core drill, drilling depth max.	mm	50(75)*
Tapping		M 14
Countersinking max. Ø	mm	31
Reaming max. Ø	mm	18
Carbide core drill bit max. Ø	mm	35
HSS core drill max. Ø	mm	35
Core drill holder		3/4" Weldon
Changing the core bit		tool-free
Stroke	mm	135
Total stroke range	mm	260
Magnetic holding power	N	10 000
Magnetic foot dimensions	mm	175 x 80
Cable with plug	m	4
Weight according to EPTA	kg	11
<b>Part number</b>		<b>7 270 56 61 00 0</b>
<b>EAN</b>		<b>4014586886770</b>
<b>Price in € [PC01]</b>		<b>1.153,95</b>

**FEIN benefits:**

- ▶ Extremely resilient construction thanks to sturdy machine design with swivel-mounted motor cable protection hose. Designed for tough use in industry and manual trades.
- ▶ Perfect power-to-weight ratio thanks to compact, weight-optimised design and FEIN 1 100 W high-power motor with high speed stability for reliable and economical working.
- ▶ With clockwise/anti-clockwise operation, electronic speed setting and a 260 mm stroke range, this is a universal tool for core drilling, twist drilling, tapping, countersinking and reaming.
- ▶ Small and lightweight.
- ▶ Simple operating concept avoids mix-ups and can be clearly seen by the user.
- ▶ Additional magnetic switch in the drill jig.
- ▶ Tool-free core bit quick change system.
- ▶ Speed-controlled tacho electronics.
- ▶ High magnetic holding force.
- ▶ Convenient magnetic holding force display.
- ▶ Integrated coolant tank.
- ▶ Feed handwheel can be moved from one side to the other.
- ▶ Tilt sensor.
- ▶ Speed saving "memory function".
- ▶ \* Also available with accessories.

**Price includes:**

- 1 case, 1 coolant tank, 1 lashing strap, 1 swarf hook, 1 centering pin, 1 contact guard



**KBM 50 Q**

Lightweight and powerful 2-speed universal magnetic core drill with clockwise/anti-clockwise operation and maximum functionality for flexible working in the workshop and on the construction site.



For accessories, see page 165

Input	W	1 200
Output	W	640
1st gear	1/min	130 - 260
2nd gear	1/min	260 - 520
Twist drill max. Ø	mm	16
Core drill, drilling depth max.	mm	50
Tapping		M 16
Countersinking max. Ø	mm	31
Reaming max. Ø	mm	16
Carbide core drill bit max. Ø	mm	50
HSS core drill max. Ø	mm	40
Core drill holder		QuickIN
Stroke	mm	145
Total stroke range	mm	315
Magnetic holding power	N	12 500
Magnetic foot dimensions	mm	195 x 90
Cable with plug	m	4
Weight according to EPTA	kg	13,2
<b>Part number</b>		<b>7 270 41 61 00 0</b>
<b>EAN</b>		<b>4014586872834</b>
<b>Price in € [PC01]</b>		<b>1.447,95</b>

**FEIN benefits:**

- ▶ Compact with high functionality for universal use on construction site and in the workshop.
- ▶ Simple operating concept avoids mix-ups and can be clearly seen by the user.
- ▶ Double drill motor guide for use with very large drilling tools.
- ▶ Reversible rotation.
- ▶ Electronic speed setting.
- ▶ FEIN high-power motor with stable speed.
- ▶ High magnetic holding force.
- ▶ Convenient magnetic holding force display.
- ▶ Integrated coolant tank.
- ▶ Feed handwheel can be moved from one side to the other.

**Price includes:**

1 case, 1 coolant tank, 1 lashing strap, 1 swarf hook, 1 centering pin, 1 contact guard

**KBM 50 U**

Lightweight and powerful 2-speed universal magnetic core drill with clockwise/anti-clockwise operation, MT3 tool mounting and maximum functionality for flexible working in the workshop and on the construction site.



For accessories, see page 165

Input	W	1 200
Output	W	610
1st gear	1/min	130 - 260
2nd gear	1/min	260 - 520
Tool Holder		MK 3
Twist drill max. Ø	mm	23
Core drill, drilling depth max.	mm	50(75)*
Tapping		M 16
Countersinking max. Ø	mm	50
Reaming max. Ø	mm	23
Carbide core drill bit max. Ø	mm	50
HSS core drill max. Ø	mm	40
Core drill holder		QuickIN
Stroke	mm	145
Total stroke range	mm	315
Magnetic holding power	N	12 500
Magnetic foot dimensions	mm	195 x 90
Cable with plug	m	4
Weight according to EPTA	kg	13,9
<b>Part number</b>		<b>7 270 40 61 00 0</b>
<b>EAN</b>		<b>4014586872995</b>
<b>Price in € [PC01]</b>		<b>1.626,45</b>

**FEIN benefits:**

- ▶ Compact with high functionality for universal use on construction site and in the workshop.
- ▶ Simple operating concept avoids mix-ups and can be clearly seen by the user.
- ▶ Double drill motor guide for use with very large drilling tools.
- ▶ Reversible rotation.
- ▶ Convenient magnetic holding force display.
- ▶ Integrated coolant tank.
- ▶ MT3 interface.
- ▶ Electronic speed setting.
- ▶ High magnetic holding force.
- ▶ \* Also available with accessories.
- ▶ FEIN high-power motor with stable speed.
- ▶ Feed handwheel can be moved from one side to the other.

**Price includes:**

1 case, 1 coolant tank, 1 lashing strap, 1 swarf hook, 1 centering pin, 1 contact guard, 1 drift key

**KBM 65 U**

Powerful and very high-performance 2-speed universal magnetic core drill with clockwise/anti-clockwise operation, MT3 tool mounting, fine adjustment and maximum functionality for flexible working in the workshop.



For accessories, see page 165

Input	W	1 300
Output	W	730
1st gear	1/min	120 - 240
2nd gear	1/min	260 - 520
Tool Holder		MK 3
Twist drill max. Ø	mm	25
Core drill, drilling depth max.	mm	50(75)*
Tapping		M 20
Countersinking max. Ø	mm	50
Reaming max. Ø	mm	25
Carbide core drill bit max. Ø	mm	65
HSS core drill max. Ø	mm	45
Core drill holder		QuickIN
Stroke	mm	145
Total stroke range	mm	315
Adjustment range for drill jigs	mm	6
Swivel range for drill jigs		7°
Magnetic holding power	N	14 000
Magnetic foot dimensions	mm	205 x 95
Cable with plug	m	4
Weight according to EPTA	kg	16,1
<b>Part number</b>		<b>7 270 43 61 00 0</b>
<b>EAN</b>		<b>4014586872902</b>
<b>Price in € [PC01]</b>		<b>2.088,45</b>

**FEIN benefits:**

- ▶ Speed stability even in tough applications.
- ▶ Fine adjustment of the drill spindle for convenient tool alignment.
- ▶ Double drill motor guide for use with very large drilling tools.
- ▶ Reversible rotation.
- ▶ Electronic speed setting.
- ▶ MT3 interface.
- ▶ High magnetic holding force.
- ▶ Convenient magnetic holding force display.
- ▶ Integrated coolant tank.
- ▶ \* Also available with accessories.

**Price includes:**

1 case, 1 coolant tank, 1 lashing strap, 1 swarf hook, 1 centering pin, 1 contact guard, 1 drift key

**KBM 80 U**

Powerful and very high-performance 3-speed universal magnetic core drill with clockwise/anti-clockwise operation, MT3 tool mounting, fine adjustment and maximum functionality for flexible working in the workshop.



For accessories, see page 176

Input	W	2 000
Output	W	900
1st gear	1/min	110 - 180
2nd gear	1/min	160 - 260
3rd gear	1/min	350 - 580
Tool Holder		MK 3
Twist drill max. Ø	mm	32
Core drill, drilling depth max.	mm	50
Tapping		M 27
Countersinking max. Ø	mm	50
Reaming max. Ø	mm	31
Carbide core drill bit max. Ø	mm	80
HSS core drill max. Ø	mm	65
Stroke	mm	145
Total stroke range	mm	285
Adjustment range for drill jigs	mm	4,25
Swivel range for drill jigs		11°
Magnetic holding power	N	18 000
Magnetic foot dimensions	mm	270 x 90
Cable with plug	m	4
Weight according to EPTA	kg	25,4
<b>Part number</b>		<b>7 270 34 00 23 0</b>
<b>EAN</b>		<b>4014586862545</b>
<b>Price in € [PC01]</b>		<b>3.197,25</b>

**FEIN benefits:**

- ▶ Speed stability even in tough applications.
- ▶ Fine adjustment of the drill spindle for convenient tool alignment.
- ▶ Double drill motor guide for use with very large drilling tools.
- ▶ Reversible rotation.
- ▶ Electronic speed setting.
- ▶ MT3 interface.
- ▶ High magnetic holding force.
- ▶ Convenient magnetic holding force display.
- ▶ Integrated coolant tank.
- ▶ Mechanical 3-speed gearbox.
- ▶ Automatic coolant supply.
- ▶ Slipping clutch torque.

**Price includes:**

1 case, 1 coolant tank, 1 lashing strap, 1 swarf hook, 2 centering pins, 1 contact guard, 1 drift key, 1 QuickIN MAX/ MT3 tool mounting



**Best of core drilling carbide accessory set**



**Best of core bits QuickIN**

Very long service life and outstanding cutting performance. Metric dimensions, cutting depth 35 mm. Set version, consisting of 6 core bits with diameters of 12, 14, 16, 18, 20 and 22 mm (cutting depth 35 mm) and 2 centring pins (105 mm) in plastic case.

Part number	Price in €
6 31 27 086 04 0	221,74



**Best of core bits 3/4" Weldon**

Very long service life and outstanding cutting performance. Metric dimensions, cutting depth 35 mm. Set version, consisting of 6 core bits with diameters of 12, 14, 16, 18, 20 and 22 mm (cutting depth 35 mm) and 2 centring pins (105 mm) in plastic case.

Part number	Price in €
6 31 27 714 02 0	221,74



**Best of core bits 3/4" Weldon**

Very long service life and outstanding cutting performance. Metric dimensions, cutting depth 50 mm. Set version, consisting of 6 core bits with diameters of 12, 14, 16, 18, 20 and 22 mm (cutting depth 50 mm) and 2 centring pins (105 mm) in plastic case.

Part number	Price in €
6 31 27 276 02 0	255,17

**Carbide core drill**



**TCT Ultra core bit with QuickIN holder**

Very long service life and outstanding cutting performance. Metric dimensions, cutting depth 35 mm.

Bore Ø mm	Part number	Price in €
12	6 31 27 086 01 9	47,11
13	6 31 27 087 01 3	47,11
14	6 31 27 088 01 1	47,11
15	6 31 27 089 01 5	47,11
15,5	6 31 27 238 01 1	47,11
16	6 31 27 090 01 7	47,11
17	6 31 27 091 01 6	47,11
17,5	6 31 27 239 01 5	47,11
18	6 31 27 092 01 9	47,11
19	6 31 27 093 01 3	47,11
19,5	6 31 27 240 01 7	47,11
20	6 31 27 094 01 1	47,11
21	6 31 27 095 01 5	47,11
22	6 31 27 096 01 8	47,11
23	6 31 27 097 01 2	47,11
24	6 31 27 098 01 0	47,11
25	6 31 27 099 01 4	47,11
26	6 31 27 100 01 5	47,11
26,5	6 31 27 241 01 6	47,11
27	6 31 27 101 01 4	47,11
28	6 31 27 102 01 7	47,11
29	6 31 27 103 01 1	54,21
30	6 31 27 104 01 9	54,21
31	6 31 27 105 01 3	54,21
32	6 31 27 106 01 6	54,21
33	6 31 27 107 01 0	54,21
34	6 31 27 108 01 8	54,21
35	6 31 27 109 01 2	54,21
36	6 31 27 110 01 4	62,77
37	6 31 27 111 01 3	62,77
38	6 31 27 112 01 6	62,77
39	6 31 27 113 01 0	62,77
40	6 31 27 114 01 8	62,77

41	6 31 27 115 01 2	74,18
42	6 31 27 116 01 5	74,18
43	6 31 27 117 01 9	74,18
44	6 31 27 118 01 7	74,18
45	6 31 27 119 01 1	74,18
46	6 31 27 120 01 3	82,79
47	6 31 27 121 01 2	82,79
48	6 31 27 122 01 5	82,79
49	6 31 27 123 01 9	82,79
50	6 31 27 124 01 7	82,79
51	6 31 27 125 01 1	91,43
52	6 31 27 126 01 4	91,43
53	6 31 27 127 01 8	91,43
54	6 31 27 128 01 6	91,43
55	6 31 27 129 01 0	91,43
56	6 31 27 130 01 2	95,39
57	6 31 27 131 01 1	95,39
58	6 31 27 132 01 4	95,39
59	6 31 27 133 01 8	95,39
60	6 31 27 134 01 6	95,39
61	6 31 27 135 01 0	107,89
62	6 31 27 136 01 3	107,89
63	6 31 27 137 01 7	107,89
64	6 31 27 138 01 5	107,89
65	6 31 27 139 01 9	107,89



**TCT Ultra core bit with QuickIN holder**

Very long service life and outstanding cutting performance. Metric dimensions, cutting depth 75 mm.

Bore Ø mm	Part number	Price in €
18	6 31 27 763 01 0	68,59
19	6 31 27 764 01 0	68,59
20	6 31 27 765 01 0	68,59
21	6 31 27 766 01 0	68,59
22	6 31 27 767 01 0	68,59
23	6 31 27 768 01 0	68,59
24	6 31 27 769 01 0	68,59
25	6 31 27 770 01 0	68,59
26	6 31 27 771 01 0	68,59
27	6 31 27 772 01 0	68,59
28	6 31 27 773 01 0	68,59
29	6 31 27 774 01 0	75,52
30	6 31 27 775 01 0	75,52
32	6 31 27 776 01 0	75,52
35	6 31 27 777 01 0	75,52
36	6 31 27 778 01 0	83,87
40	6 31 27 779 01 0	83,87
45	6 31 27 780 01 0	94,99
50	6 31 27 781 01 0	103,37
55	6 31 27 782 01 0	111,84
60	6 31 27 783 01 0	115,68
65	6 31 27 784 01 0	127,88



**TCT Ultra 50 core bit with FEIN thread M 18 x 6 P 1.5**

Very long service life and outstanding cutting performance. Metric dimensions, cutting depth 50 mm.

Bore Ø mm	Part number	Price in €
12	6 31 27 042 01 4	50,84
13	6 31 27 043 01 8	50,84
14	6 31 27 044 01 6	50,84
15	6 31 27 045 01 0	50,84
16	6 31 27 046 01 3	50,84
17	6 31 27 047 01 7	50,84
18	6 31 27 001 01 5	50,84
19	6 31 27 019 01 2	50,84
20	6 31 27 002 01 8	50,84

21	6 31 27 020 01 4	50,84
22	6 31 27 003 01 2	50,84
23	6 31 27 021 01 3	50,84
24	6 31 27 022 01 6	50,84
25	6 31 27 004 01 0	50,84
26	6 31 27 005 01 4	50,84
27	6 31 27 023 01 0	50,84
28	6 31 27 006 01 7	50,84
29	6 31 27 024 01 8	50,84
30	6 31 27 007 01 1	50,84
31	6 31 27 025 01 2	56,83
32	6 31 27 008 01 9	56,83
33	6 31 27 026 01 5	56,83
34	6 31 27 009 01 3	56,83
35	6 31 27 010 01 5	56,83
36	6 31 27 027 01 9	65,79
37	6 31 27 028 01 7	65,79
38	6 31 27 011 01 4	65,79
39	6 31 27 029 01 1	65,79
40	6 31 27 012 01 7	65,79
41	6 31 27 030 01 3	77,70
42	6 31 27 013 01 1	77,70
43	6 31 27 014 01 9	77,70
44	6 31 27 031 01 2	77,70
45	6 31 27 015 01 3	77,70
46	6 31 27 032 01 5	86,76
47	6 31 27 033 01 9	86,76
48	6 31 27 016 01 6	86,76
49	6 31 27 034 01 7	86,76
50	6 31 27 017 01 0	86,76
51	6 31 27 035 01 1	95,87
52	6 31 27 018 01 8	95,87
53	6 31 27 036 01 4	95,87
54	6 31 27 037 01 8	95,87
55	6 31 27 038 01 6	95,87
56	6 31 27 039 01 0	99,92
57	6 31 27 040 01 2	99,92
58	6 31 27 041 01 1	99,92
59	6 31 27 049 01 9	101,39
60	6 31 27 050 01 1	101,39
61	6 31 27 051 01 0	114,73
62	6 31 27 052 01 3	114,73
63	6 31 27 053 01 7	114,73
64	6 31 27 054 01 5	114,73
65	6 31 27 055 01 9	114,73



**TCT Ultra 35 core bit with 3/4" Weldon holder**  
Very long service life and outstanding cutting performance.  
Metric dimensions, cutting depth 35 mm.

Bore Ø mm	Part number	Price in €
12	6 31 27 714 01 0	45,75
13	6 31 27 715 01 0	45,75
14	6 31 27 716 01 0	45,75
15	6 31 27 717 01 0	45,75
16	6 31 27 718 01 0	45,75
17	6 31 27 719 01 0	45,75
18	6 31 27 720 01 0	45,75
19	6 31 27 721 01 0	45,75
20	6 31 27 722 01 0	45,75
21	6 31 27 723 01 0	45,75
22	6 31 27 724 01 0	45,75
23	6 31 27 725 01 0	45,75
24	6 31 27 726 01 0	45,75
25	6 31 27 727 01 0	45,75
26	6 31 27 728 01 0	45,75
27	6 31 27 729 01 0	45,75
28	6 31 27 730 01 0	45,75

29	6 31 27 731 01 0	52,65
30	6 31 27 732 01 0	52,65
31	6 31 27 733 01 0	52,65
32	6 31 27 734 01 0	52,65
33	6 31 27 735 01 0	52,65
34	6 31 27 736 01 0	52,65
35	6 31 27 737 01 0	52,65
36	6 31 27 738 01 0	60,94
37	6 31 27 739 01 0	60,94
38	6 31 27 740 01 0	60,94
39	6 31 27 741 01 0	60,94
40	6 31 27 742 01 0	60,94
41	6 31 27 743 01 0	72,03
42	6 31 27 744 01 0	72,03
43	6 31 27 745 01 0	72,03
44	6 31 27 746 01 0	72,03
45	6 31 27 747 01 0	72,03
46	6 31 27 748 01 0	80,36
47	6 31 27 749 01 0	80,36
48	6 31 27 750 01 0	80,36
49	6 31 27 751 01 0	80,36
50	6 31 27 752 01 0	80,36
51	6 31 27 753 01 0	88,78
52	6 31 27 754 01 0	88,78
53	6 31 27 755 01 0	88,78
54	6 31 27 756 01 0	88,78
55	6 31 27 757 01 0	88,78
56	6 31 27 758 01 0	92,61
57	6 31 27 759 01 0	92,61
58	6 31 27 760 01 0	92,61
59	6 31 27 761 01 0	92,61
60	6 31 27 762 01 0	92,61



**TCT Ultra 50 core bit with 3/4" Weldon holder**  
Very long service life and outstanding cutting performance.  
Metric dimensions, cutting depth 50 mm.

Bore Ø mm	Part number	Price in €
12	6 31 27 276 01 0	50,84
13	6 31 27 277 01 0	50,84
14	6 31 27 278 01 0	50,84
15	6 31 27 279 01 0	50,84
16	6 31 27 280 01 0	50,84
17	6 31 27 281 01 0	50,84
18	6 31 27 282 01 0	50,84
19	6 31 27 283 01 0	50,84
20	6 31 27 284 01 0	50,84
21	6 31 27 285 01 0	50,84
22	6 31 27 286 01 0	50,84
23	6 31 27 287 01 0	50,84
24	6 31 27 288 01 0	50,84
25	6 31 27 289 01 0	50,84
26	6 31 27 290 01 0	50,84
27	6 31 27 291 01 0	50,84
28	6 31 27 292 01 0	50,84
29	6 31 27 293 01 0	50,84
30	6 31 27 294 01 0	50,84
31	6 31 27 295 01 0	56,83
32	6 31 27 296 01 0	56,83
33	6 31 27 297 01 0	56,83
34	6 31 27 298 01 0	56,83
35	6 31 27 299 01 0	56,83
36	6 31 27 300 01 0	65,79
37	6 31 27 301 01 0	65,79
38	6 31 27 302 01 0	65,79
39	6 31 27 303 01 0	65,79
40	6 31 27 304 01 0	65,79
41	6 31 27 305 01 0	77,70



42	6 31 27 306 01 0	77,70
43	6 31 27 307 01 0	77,70
44	6 31 27 308 01 0	77,70
45	6 31 27 309 01 0	77,70
46	6 31 27 310 01 0	86,76
47	6 31 27 311 01 0	86,76
48	6 31 27 312 01 0	86,76
49	6 31 27 313 01 0	86,76
50	6 31 27 314 01 0	86,76
51	6 31 27 315 01 0	95,87
52	6 31 27 316 01 0	95,87
53	6 31 27 317 01 0	95,87
54	6 31 27 318 01 0	95,87
55	6 31 27 319 01 0	95,87
56	6 31 27 320 01 0	99,92
57	6 31 27 321 01 0	99,92
58	6 31 27 322 01 0	99,92
59	6 31 27 323 01 0	99,92
60	6 31 27 324 01 0	99,92
61	6 31 27 325 01 0	113,06
62	6 31 27 326 01 0	113,06
63	6 31 27 327 01 0	113,06
64	6 31 27 328 01 0	113,06
65	6 31 27 329 01 0	113,06



**TCT Ultra 75 core bit with 3/4" Weldon holder**  
Very long service life and outstanding cutting performance.  
Metric dimensions, cutting depth 75 mm.

Bore Ø mm	Part number	Price in €
18	6 31 27 785 01 0	68,59
19	6 31 27 786 01 0	68,59
20	6 31 27 787 01 0	68,59
21	6 31 27 788 01 0	68,59
22	6 31 27 789 01 0	68,59
23	6 31 27 790 01 0	68,59
24	6 31 27 791 01 0	68,59
25	6 31 27 792 01 0	68,59
26	6 31 27 793 01 0	68,59
27	6 31 27 794 01 0	68,59
28	6 31 27 795 01 0	68,59
29	6 31 27 796 01 0	75,52
30	6 31 27 797 01 0	75,52
32	6 31 27 798 01 0	75,52
35	6 31 27 799 01 0	75,52
36	6 31 27 800 01 0	83,87
40	6 31 27 801 01 0	83,87
45	6 31 27 802 01 0	94,99
50	6 31 27 803 01 0	103,37
55	6 31 27 804 01 0	111,84
60	6 31 27 805 01 0	115,68
65	6 31 27 806 01 0	127,88

**Best of core drilling HSS accessory set**



**Best of core bits QuickIN**  
Industrial standard. Metric dimensions, cutting depth 50 mm.  
Set version, consisting of 6 core bits with diameters of 12, 14, 16, 18, 20 and 22 mm (cutting depth 50 mm) and 2 centring pins (105 mm) in plastic case.

Part number	Price in €
6 31 33 999 01 0	166,03



**Best of core bits 3/4" Weldon**

Industrial standard. Metric dimensions, cutting depth 25 mm.  
Set version, consisting of 6 core bits with diameters of 12, 14, 16, 18, 20 and 22 mm (cutting depth 25 mm) and 2 centring pins (80 mm) in plastic case.

Part number	Price in €
6 31 34 999 06 1	132,60



**Best of core bits 3/4" Weldon**

Industrial standard. Metric dimensions, cutting depth 25 mm.  
Set version, consisting of 4 core bits, 2x 14 mm diameter, 2x 18 mm diameter, (cutting depth 25 mm) and 1 centring pin (80 mm) in plastic case.

Part number	Price in €
6 31 34 999 06 2	83,57



**Best of core bits 3/4" Weldon**

Industrial standard. Metric dimensions, cutting depth 50 mm.  
Set version, consisting of 6 core bits with diameters of 12, 14, 16, 18, 20 and 22 mm (cutting depth 50 mm) and 2 centring pins (105 mm) in plastic case.

Part number	Price in €
6 31 34 999 06 3	166,03



**Best of core bits 3/4" Weldon**

Industrial standard. Metric dimensions, cutting depth 50 mm.  
Set version, consisting of 4 core bits, 2x 14 mm diameter, 2x 18 mm diameter, (cutting depth 50 mm) and 1 centring pin (105 mm) in plastic case.

Part number	Price in €
6 31 34 999 06 4	110,31

**HSS core drill**



**HSS Nova 25 core bit with QuickIN holder**

Industrial standard. Metric dimensions, cutting depth 25 mm.

Bore Ø mm	Part number	Price in €
12	6 31 33 119 05 1	18,26
13	6 31 33 129 05 1	18,26
14	6 31 33 140 05 1	18,26
15	6 31 33 150 05 1	18,26
16	6 31 33 159 05 1	18,26
17	6 31 33 170 05 1	19,92
18	6 31 33 180 05 1	19,92
19	6 31 33 189 05 1	19,92
20	6 31 33 199 06 3	23,25
21	6 31 33 210 05 1	23,25
22	6 31 33 219 05 1	23,25
23	6 31 33 229 05 1	26,58
24	6 31 33 240 05 1	26,58
25	6 31 33 250 05 1	26,58
26	6 31 33 259 05 1	31,00
27	6 31 33 270 05 1	31,00
28	6 31 33 279 05 1	33,21
29	6 31 33 289 05 1	33,21
30	6 31 33 299 05 1	35,43
31	6 31 33 309 05 1	35,43
32	6 31 33 319 05 1	40,95
33	6 31 33 329 05 1	40,95
34	6 31 33 339 05 1	46,47
35	6 31 33 350 05 1	46,47
36	6 31 33 359 05 1	46,47
37	6 31 33 369 05 1	54,22



38	6 31 33 379 05 1	54,22
39	6 31 33 389 05 1	54,22
40	6 31 33 399 05 1	60,87
41	6 31 33 409 05 1	60,87
42	6 31 33 420 05 1	66,40
43	6 31 33 429 05 1	66,40
44	6 31 33 439 05 1	69,73
45	6 31 33 449 05 1	69,73
46	6 31 33 459 05 1	79,70
47	6 31 33 469 05 1	79,70
48	6 31 33 479 05 1	83,00
49	6 31 33 489 05 1	83,00
50	6 31 33 499 05 1	83,00



**HSS Nova 50 core bit with QuickIN holder**  
Industrial standard. Metric dimensions, cutting depth 50 mm.

Bore Ø mm	Part number	Price in €
12	6 31 33 119 05 2	25,63
13	6 31 33 129 05 2	25,63
14	6 31 33 140 05 2	25,63
15	6 31 33 150 05 2	25,63
16	6 31 33 159 05 2	25,63
17	6 31 33 170 05 2	27,95
18	6 31 33 180 05 2	27,95
19	6 31 33 189 05 2	27,95
20	6 31 33 199 05 2	32,62
21	6 31 33 210 05 2	32,62
22	6 31 33 219 05 2	32,62
23	6 31 33 229 05 2	32,62
24	6 31 33 240 05 2	34,95
25	6 31 33 250 05 2	39,62
26	6 31 33 259 05 2	39,62
27	6 31 33 270 05 2	39,62
28	6 31 33 279 05 2	46,60
29	6 31 33 289 05 2	46,60
30	6 31 33 299 05 2	46,60
31	6 31 33 309 05 2	52,43
32	6 31 33 319 05 2	52,43
33	6 31 33 329 05 2	58,26
34	6 31 33 339 05 2	58,26
35	6 31 33 350 05 2	58,26
36	6 31 33 359 05 2	66,40
37	6 31 33 369 05 2	66,40
38	6 31 33 379 05 2	66,40
39	6 31 33 389 05 2	75,73
40	6 31 33 399 05 2	75,73
41	6 31 33 409 05 2	81,54
42	6 31 33 420 05 2	88,54
43	6 31 33 429 05 2	88,54
44	6 31 33 439 05 2	88,54
45	6 31 33 449 05 2	93,20
46	6 31 33 459 05 2	102,51
47	6 31 33 469 05 2	102,51
48	6 31 33 479 05 2	107,17
49	6 31 33 489 05 2	107,17
50	6 31 33 499 05 2	110,68



**HSS Nova 25 core bit with 3/4" Weldon holder**  
Industrial standard. Metric dimensions, cutting depth 25 mm.

Bore Ø mm	Part number	Price in €
12	6 31 34 120 05 1	18,26
13	6 31 34 130 05 1	18,26
14	6 31 34 140 05 1	18,26
15	6 31 34 150 05 1	18,26
16	6 31 34 160 05 1	18,26
17	6 31 34 170 05 1	19,92
18	6 31 34 180 05 1	19,92
19	6 31 34 190 05 1	19,92
20	6 31 34 200 05 1	23,25
21	6 31 34 210 05 1	23,25
22	6 31 34 220 05 1	23,25
23	6 31 34 230 05 1	26,58
24	6 31 34 240 05 1	26,58
25	6 31 34 250 05 1	26,58
26	6 31 34 260 05 1	31,00
27	6 31 34 270 05 1	31,00
28	6 31 34 280 05 1	33,21
29	6 31 34 290 05 1	33,21
30	6 31 34 300 05 1	35,43
31	6 31 34 310 05 1	35,43
32	6 31 34 320 05 1	40,95
33	6 31 34 330 05 1	40,95
34	6 31 34 340 05 1	46,47
35	6 31 34 350 05 1	46,47
36	6 31 34 360 05 1	46,47
37	6 31 34 370 05 1	54,22
38	6 31 34 380 05 1	54,22
39	6 31 34 390 05 1	54,22
40	6 31 34 400 05 1	60,87
41	6 31 34 410 05 1	60,87
42	6 31 34 420 05 1	66,40
43	6 31 34 430 05 1	66,40
44	6 31 34 440 05 1	69,73
45	6 31 34 450 05 1	69,73
46	6 31 34 460 05 1	79,70
47	6 31 34 470 05 1	79,70
48	6 31 34 480 05 1	83,00
49	6 31 34 490 05 1	83,00
50	6 31 34 500 05 1	83,00
51	6 31 34 510 05 1	88,54
52	6 31 34 520 05 1	88,54
53	6 31 34 530 05 1	94,08
54	6 31 34 540 05 1	94,08
55	6 31 34 550 05 1	102,92
56	6 31 34 560 05 1	117,32
57	6 31 34 570 05 1	117,32
58	6 31 34 580 05 1	126,17
59	6 31 34 590 05 1	126,17
60	6 31 34 600 05 1	126,17





**HSS Nova 50 core bit with 3/4" Weldon holder**  
Industrial standard. Metric dimensions, cutting depth 50 mm.

Bore Ø mm	Part number	Price in €
12	6 31 34 120 05 2	25,63
13	6 31 34 130 05 2	25,63
14	6 31 34 140 05 2	25,63
15	6 31 34 150 05 2	25,63
16	6 31 34 160 05 2	25,63
17	6 31 34 170 05 2	27,95
18	6 31 34 180 05 2	27,95
19	6 31 34 190 05 2	27,95
20	6 31 34 200 05 2	32,62
21	6 31 34 210 05 2	32,62
22	6 31 34 220 05 2	32,62
23	6 31 34 230 05 2	32,62
24	6 31 34 240 05 2	34,95
25	6 31 34 250 05 2	39,62
26	6 31 34 260 05 2	39,62
27	6 31 34 270 05 2	39,62
28	6 31 34 280 05 2	46,60
29	6 31 34 290 05 2	46,60
30	6 31 34 300 05 2	46,60
31	6 31 34 310 05 2	52,43
32	6 31 34 320 05 2	52,43
33	6 31 34 330 05 2	58,26
34	6 31 34 340 05 2	58,26
35	6 31 34 350 05 2	58,26
36	6 31 34 360 05 2	66,40
37	6 31 34 370 05 2	66,40
38	6 31 34 380 05 2	66,40
39	6 31 34 390 05 2	75,73
40	6 31 34 400 05 2	75,73
41	6 31 34 410 05 2	81,54
42	6 31 34 420 05 2	88,54
43	6 31 34 430 05 2	88,54
44	6 31 34 440 05 2	88,54
45	6 31 34 450 05 2	93,20
46	6 31 34 460 05 2	102,51
47	6 31 34 470 05 2	102,51
48	6 31 34 480 05 2	107,17
49	6 31 34 490 05 2	107,17
50	6 31 34 500 05 2	110,68
51	6 31 34 510 05 2	122,33
52	6 31 34 520 05 2	122,33
53	6 31 34 530 05 2	122,33
54	6 31 34 540 05 2	128,15
55	6 31 34 550 05 2	128,15
56	6 31 34 560 05 2	133,96
57	6 31 34 570 05 2	133,96
58	6 31 34 580 05 2	143,29
59	6 31 34 590 05 2	143,29
60	6 31 34 600 05 2	143,29



**HSS Nova 75 core bit with 3/4" Weldon holder**  
Industrial standard. Metric dimensions, cutting depth 75 mm.

Bore Ø mm	Part number	Price in €
19	6 31 34 190 05 3	60,01
20	6 31 34 200 05 3	60,01
21	6 31 34 210 05 3	64,80
22	6 31 34 220 05 3	64,80
23	6 31 34 230 05 3	64,80
24	6 31 34 240 05 3	64,80
25	6 31 34 250 05 3	75,60
26	6 31 34 260 05 3	75,60
27	6 31 34 270 05 3	75,60
28	6 31 34 280 05 3	84,01
29	6 31 34 290 05 3	84,01
30	6 31 34 300 05 3	97,20
32	6 31 34 320 05 3	97,20
35	6 31 34 350 05 3	104,39
36	6 31 34 360 05 3	112,80
40	6 31 34 400 05 3	138,00
45	6 31 34 450 05 3	143,99
50	6 31 34 500 05 3	161,99
60	6 31 34 600 05 3	197,99



**HSS DURA 25 core bit with QuickIN holder**  
TiN surface coating for outstanding service lives and the best glide properties.  
Metric dimensions, cutting depth 25 mm.

Bore Ø mm	Part number	Price in €
12	6 31 33 120 06 7	26,90
13	6 31 33 130 06 7	26,90
14	6 31 33 140 06 7	26,90
15	6 31 33 150 06 7	26,90
16	6 31 33 160 06 7	26,90
17	6 31 33 170 06 7	29,36
18	6 31 33 180 06 7	29,36
19	6 31 33 190 06 7	29,36
20	6 31 33 200 06 7	33,02
21	6 31 33 210 06 7	33,02
22	6 31 33 220 06 7	33,02
23	6 31 33 230 06 7	40,36
24	6 31 33 240 06 7	40,36
25	6 31 33 250 06 7	40,36
26	6 31 33 260 06 7	44,04
27	6 31 33 270 06 7	44,04
28	6 31 33 280 06 7	47,70
29	6 31 33 290 06 7	47,70
30	6 31 33 300 06 7	52,59
31	6 31 33 310 06 7	52,59
32	6 31 33 320 06 7	59,94
33	6 31 33 330 06 7	59,94
34	6 31 33 340 06 7	66,06
35	6 31 33 350 06 7	66,06
36	6 31 33 360 06 7	66,06
37	6 31 33 370 06 7	74,62
38	6 31 33 380 06 7	74,62
39	6 31 33 390 06 7	74,62
40	6 31 33 400 06 7	83,16
41	6 31 33 410 06 7	83,16
42	6 31 33 420 06 7	90,52
43	6 31 33 430 06 7	90,52
44	6 31 33 440 06 7	96,62
45	6 31 33 450 06 7	96,62
46	6 31 33 460 06 7	107,64
47	6 31 33 470 06 7	107,64
48	6 31 33 480 06 7	117,43
49	6 31 33 490 06 7	117,43
50	6 31 33 500 06 7	117,43



**HSS DURA 50 core bit with QuickIN holder**

TiN surface coating for outstanding service lives and the best glide properties.

Metric dimensions, cutting depth 50 mm.

Bore Ø mm	Part number	Price in €
12	6 31 33 120 06 8	34,24
13	6 31 33 130 06 8	34,24
14	6 31 33 140 06 8	34,24
15	6 31 33 150 06 8	34,24
16	6 31 33 160 06 8	34,24
17	6 31 33 170 06 8	36,71
18	6 31 33 180 06 8	36,71
19	6 31 33 190 06 8	36,71
20	6 31 33 200 06 8	41,60
21	6 31 33 210 06 8	41,60
22	6 31 33 220 06 8	41,60
23	6 31 33 230 06 8	48,93
24	6 31 33 240 06 8	48,93
25	6 31 33 250 06 8	48,93
26	6 31 33 260 06 8	55,05
27	6 31 33 270 06 8	55,05
28	6 31 33 280 06 8	59,94
29	6 31 33 290 06 8	59,94
30	6 31 33 300 06 8	66,06
31	6 31 33 310 06 8	66,06
32	6 31 33 320 06 8	74,62
33	6 31 33 330 06 8	74,62
34	6 31 33 340 06 8	83,16
35	6 31 33 350 06 8	83,16
36	6 31 33 360 06 8	83,16
37	6 31 33 370 06 8	92,97
38	6 31 33 380 06 8	92,97
39	6 31 33 390 06 8	92,97
40	6 31 33 400 06 8	103,97
41	6 31 33 410 06 8	103,97
42	6 31 33 420 06 8	113,75
43	6 31 33 430 06 8	113,75
44	6 31 33 440 06 8	122,33
45	6 31 33 450 06 8	122,33
46	6 31 33 460 06 8	137,01
47	6 31 33 470 06 8	137,01
48	6 31 33 480 06 8	146,78
49	6 31 33 490 06 8	146,78
50	6 31 33 500 06 8	146,78



**HSS DURA 25 core bit with 3/4" Weldon holder**

TiN surface coating for outstanding service lives and the best glide properties.

Metric dimensions, cutting depth 25 mm.

Bore Ø mm	Part number	Price in €
12	6 31 34 120 07 5	26,90
13	6 31 34 130 07 5	26,90
14	6 31 34 140 07 5	26,90
15	6 31 34 150 07 5	26,90
16	6 31 34 160 07 5	26,90
17	6 31 34 170 07 5	29,36
18	6 31 34 180 07 5	29,36
19	6 31 34 190 07 5	29,36
20	6 31 34 200 07 5	33,02
21	6 31 34 210 07 5	33,02
22	6 31 34 220 07 5	33,02
23	6 31 34 230 07 5	40,36
24	6 31 34 240 07 5	40,36
25	6 31 34 250 07 5	40,36
26	6 31 34 260 07 5	44,04
27	6 31 34 270 07 5	44,04
28	6 31 34 280 07 5	47,70
29	6 31 34 290 07 5	47,70

30	6 31 34 300 07 5	52,59
31	6 31 34 310 07 5	52,59
32	6 31 34 320 07 5	59,94
33	6 31 34 330 07 5	59,94
34	6 31 34 340 07 5	66,06
35	6 31 34 350 07 5	66,06
36	6 31 34 360 07 5	66,06
37	6 31 34 370 07 5	74,62
38	6 31 34 380 07 5	74,62
39	6 31 34 390 07 5	74,62
40	6 31 34 400 07 5	83,16
41	6 31 34 410 07 5	83,16
42	6 31 34 420 07 5	90,52
43	6 31 34 430 07 5	90,52
44	6 31 34 440 07 5	96,62
45	6 31 34 450 07 5	96,62
46	6 31 34 460 07 5	107,64
47	6 31 34 470 07 5	107,64
48	6 31 34 480 07 5	117,43
49	6 31 34 490 07 5	117,43
50	6 31 34 500 07 5	117,43
51	6 31 34 510 07 5	124,76
52	6 31 34 520 07 5	124,76
53	6 31 34 530 07 5	130,88
54	6 31 34 540 07 5	130,88
55	6 31 34 550 07 5	134,56
56	6 31 34 560 07 5	140,67
57	6 31 34 570 07 5	140,67
58	6 31 34 580 07 5	152,90
59	6 31 34 590 07 5	152,90
60	6 31 34 600 07 5	152,90



**HSS DURA 50 core bit with 3/4" Weldon holder**

TiN surface coating for outstanding service lives and the best glide properties.

Metric dimensions, cutting depth 50 mm.

Bore Ø mm	Part number	Price in €
12	6 31 34 120 07 6	34,24
13	6 31 34 130 07 6	34,24
14	6 31 34 140 07 6	34,24
15	6 31 34 150 07 6	34,24
16	6 31 34 160 07 6	34,24
17	6 31 34 170 07 6	36,71
18	6 31 34 180 07 6	36,71
19	6 31 34 190 07 6	36,71
20	6 31 34 200 07 6	41,60
21	6 31 34 210 07 6	41,60
22	6 31 34 220 07 6	41,60
23	6 31 34 230 07 6	48,93
24	6 31 34 240 07 6	48,93
25	6 31 34 250 07 6	48,93
26	6 31 34 260 07 6	55,05
27	6 31 34 270 07 6	55,05
28	6 31 34 280 07 6	59,94
29	6 31 34 290 07 6	59,94
30	6 31 34 300 07 6	66,06
31	6 31 34 310 07 6	66,06
32	6 31 34 320 07 6	74,62
33	6 31 34 330 07 6	74,62
34	6 31 34 340 07 6	83,16
35	6 31 34 350 07 6	83,16
36	6 31 34 360 07 6	83,16
37	6 31 34 370 07 6	92,97
38	6 31 34 380 07 6	92,97
39	6 31 34 390 07 6	92,97
40	6 31 34 400 07 6	103,97
41	6 31 34 410 07 6	103,97
42	6 31 34 420 07 6	113,75

43	6 31 34 430 07 6	113,75
44	6 31 34 440 07 6	122,33
45	6 31 34 450 07 6	122,33
46	6 31 34 460 07 6	137,01
47	6 31 34 470 07 6	137,01
48	6 31 34 480 07 6	146,78
49	6 31 34 490 07 6	146,78
50	6 31 34 500 07 6	146,78
51	6 31 34 510 07 6	156,57
52	6 31 34 520 07 6	156,57
53	6 31 34 530 07 6	165,12
54	6 31 34 540 07 6	165,12
55	6 31 34 550 07 6	168,80
56	6 31 34 560 07 6	176,14
57	6 31 34 570 07 6	176,14
58	6 31 34 580 07 6	190,83
59	6 31 34 590 07 6	190,83
60	6 31 34 600 07 6	190,83

**Centering pins**

 **Centering pins**

L mm	Part number	Price in €
80	3 02 17 359 00 0	13,32
105	3 02 17 332 00 9	13,73
125	3 02 17 333 00 3	13,73
135	3 02 17 355 00 0	16,47

 **Centering pins**  
only for 7/16" HSS NOVA 1" core drills.

L mm	Part number	Price in €
85	3 02 17 338 00 0	12,23

 **Centering pins**  
only for 7/16" competitor core drill in combination with adapter

L mm	Part number	Price in €
125	3 02 17 337 00 2	16,47

**Adapter/drill chuck**

 **QuickIN-adapter**  
Output M18 x 6 P 1.5

Part number	Price in €
6 39 01 020 00 6	20,20

 **QuickIN-adapter**  
Output 3/4" Weldon

Part number	Price in €
6 39 01 021 01 4	20,20

 **QuickIN-adapter**  
Special Weldon output. Specially designed for core bits from other manufacturers that have an internal hole of > 6.4 mm.

Part number	Price in €
6 39 01 024 01 9	20,20

 **QuickIN-adapter**  
Output 1/2"

Part number	Price in €
6 39 01 022 00 8	20,20

 **QuickIN-adapter**  
Output B 16

Part number	Price in €
6 39 01 023 00 2	20,20

 **Adapter with 3/4" Weldon fitting**  
for converting competitor products to the QuickIN system.

Part number	Price in €
6 39 01 027 01 0	43,45

 **Adapter with 3/4" Weldon fitting**  
Output B 16

Part number	Price in €
6 39 01 061 00 0	20,20

 **Extension**  
for use on confined, deep, or layered surfaces, through holes possible as of Ø 36 mm. QuickIN fitting, length 100 mm, including centring pin.

Part number	Price in €
6 31 06 016 01 0	73,07

 **Key-type drill chuck with QuickIN holder**

Chuck opening mm	Part number	Price in €
1,5 - 13	6 39 01 023 02 0	65,43
1 - 16	6 39 01 023 01 1	77,55

 **HSS spiral drill with QuickIN fitting**  
Cutting depth 35 mm

Bore Ø mm	Part number	Price in €
10	6 31 11 009 01 0	18,90
10,2	6 31 11 010 01 0	18,90
11	6 31 11 011 01 0	21,53
12	6 31 11 012 01 0	21,53
13	6 31 11 013 01 0	23,10
14	6 31 11 014 01 0	23,10
15	6 31 11 015 01 0	24,15
15,5	6 31 11 016 01 0	24,15

Metal core drilling

**Drive arbors**



**QuickIN-adaptors**  
With internal cooling lubricant supply.

Cutting depth mm	Taper	Bore Ø mm	Part number	Price in €
50	MT 2	12 - 35	6 39 01 065 02 0	160,02
75	MT 2	12 - 35	6 39 01 066 02 0	171,50
50	MK 3	12 - 65	6 39 01 048 02 0	160,02
75	MK 3	12 - 65	6 39 01 049 02 0	171,50



**3/4" Weldon mounting shaft**  
With internal cooling lubricant supply.

Cutting depth mm	Taper	Bore Ø mm	Part number	Price in €
50	MT 2	12 - 35	6 39 01 063 02 0	160,02
75	MT 2	12 - 35	6 39 01 064 02 0	171,50
50	MK 3	12 - 65	6 39 01 050 02 0	160,02
75	MK 3	12 - 65	6 39 01 051 02 0	171,50



**QuickIN-adaptors**  
for using FEIN core drills on bench and column drilling machines and all other core drilling units with MT fitting.

Cutting depth mm	Taper	Bore Ø mm	Part number	Price in €
50	MK 3	12 - 65	6 39 01 019 01 3	168,09
50	MT 2	12 - 35	6 39 01 018 01 9	160,02
75	MK 3	12 - 65	6 39 01 055 02 0	179,56
75	MT 2	12 - 35	6 39 01 057 02 0	179,56



**3/4" Weldon mounting shaft**  
for using FEIN core drills on bench and column drilling machines and all other core drilling units with MT fitting.

Cutting depth mm	Taper	Bore Ø mm	Part number	Price in €
50	MK 3	12 - 65	6 39 01 052 02 0	168,09
75	MK 3	12 - 65	6 39 01 053 02 0	179,56



**Retro-fitting kit**  
for former model KBM 542 to QuickIN rapid change system.

Part number	Price in €
6 39 01 028 01 8	108,57

**Tapping**



**Tapping rapid change chuck for KBM 50 Q, KBM 50 U, KBM 52 U, KBM 65 U**  
Can only be used for magnetic core drills with reverse running function. Size 2, with 3/4" Weldon fitting, for thread drills, in conjunction with tapping inserts with or without M6 - M20 safety clutch.

Part number	Price in €
9 26 02 089 01 0	255,97



**Tapping rapid change chuck for KBM 50 Q, KBM 50 U, KBM 52 U, KBM 65 U**  
can only be used for core drilling units with left-hand running function. Size 2, with QuickIN fitting, for tapping drills in connection with tapping inserts with or without slipping clutch M 6 - M 20.

Part number	Price in €
9 26 02 079 01 0	251,69



**Thread cutting tool for KBM 32 Q and KBM 50 QX**  
Size 2, with QuickIN fitting, for tapping drills in connection with tapping inserts with or without slipping clutch M6 - M16. Including torque support.

Part number	Price in €
9 26 02 072 01 2	865,20



**Thread cutting tool for KBM 65 Q and KBM 65 QF**  
Size 2, with MT 3 fitting, for tapping drills in connection with tapping inserts with or without slipping clutch M6 - M20. Including torque support.

Part number	Price in €
9 26 02 066 01 2	1.167,60



**Tapping Inserts**  
for thread drills in accordance with DIN 371

Thread	Ø mm	Square mm	Part number	Price in €
M 6	6	4,9	6 32 06 095 01 1	68,60
M 8	8	6,2	6 32 06 138 01 0	68,60
M 10	10	8	6 32 06 139 01 0	68,60



**Tapping Inserts**  
for thread drills in accordance with DIN 374/376

Thread	Ø mm	Square mm	Part number	Price in €
M 6	4,5	3,4	6 32 06 117 01 5	68,60
M 10	7	5,5	6 32 06 096 01 4	68,60
M 12	9	7	6 32 06 097 01 8	68,60
M 14	11	9	6 32 06 098 01 6	68,60
M 16	12	9	6 32 06 099 01 0	68,60
M 18	14	11	6 32 06 100 01 1	68,60
M 20	16	12	6 32 06 101 01 0	68,60



**Tapping Inserts**  
with safety coupling for blind holes.  
for thread drills in accordance with DIN 371

Thread	Ø mm	Square mm	Part number	Price in €
M 6	6	4,9	6 32 06 118 01 3	213,51
M 8	8	6,2	6 32 06 140 01 0	213,51
M 10	10	8	6 32 06 141 01 0	213,51



**Tapping Inserts**  
with safety coupling for blind holes.  
for thread drills in accordance with DIN 374/376

Thread	Ø mm	Square mm	Part number	Price in €
M 8	6	4,9	6 32 06 102 01 3	213,51
M 10	7	5,5	6 32 06 103 01 7	213,51
M 12	9	7	6 32 06 104 01 5	213,51
M 14	11	9	6 32 06 105 01 9	213,51
M 16	12	9	6 32 06 106 01 2	213,51
M 18	14	11	6 32 06 107 01 6	213,51
M 20	16	12	6 32 06 108 01 4	213,51



**Clamping fixtures**



**Vacuum plate**  
for anti-magnetic materials and structured bases  
(corrugated sheet, stud plate etc.)  
Vacuum plate 396 x 200 x 95 mm

Part number	Price in €
9 26 02 057 01 7	484,09



**Vacuum pump**  
Suction rate 0,015 m<sup>3</sup>/min, -0,8 bar, 92 W, weight 2,5 kg  
including suction hose

Part number	Price in €
9 26 01 022 01 3	499,09



**Suction plate**  
for anti-magnetic materials, 250 x 330 x 110 mm

Part number	Price in €
9 26 02 054 01 6	465,89



**Pipe drilling device**  
incl. clamping strap, for positioning bores on pipes with pipe  
Ø of 60 to 300 mm, 220 x 130 mm.

Part number	Price in €
9 26 02 055 01 0	253,83

**Cooling**



**Pump**  
Capacity approx. 450 ml. Suited to FEIN core drilling units  
KBM 32 Q, KBM 50 QX, KBM 52 U, KBM 65 Q, KBM 65 QF.

Part number	Price in €
3 21 32 022 00 7	9,59

**Replacement hose**  
for hand pump 3 21 32 022 00 7.

Part number	Price in €
3 14 14 054 00 8	3,14



**Flex-jointed hose**  
Suitable for KBM 50 Q, 50 U, 50 auto, 65 U when using  
twist drills.

Part number	Price in €
3 14 14 070 01 0	12,62



**Cutting spray**  
300 ml pump spray, for long tool life, optimum cutting  
performance and enhanced swarf flow.

Part number	Price in €
3 21 32 031 00 0	15,20



**Cutting paste**  
Lubricating agents for working on sheet metals.

Part number	Price in €
3 21 32 020 12 9	14,11

**Other accessories**



**Magbrush**  
Practical tool with high magnetic force for quick and easy  
collection of magnetic metal swarf.

Part number	Price in €
6 42 01 005 01 0	42,61



	KBM 50 auto	KBM 80 auto	
	Lightweight, powerful and ingenious 2-speed auto magnetic core drill offering maximum efficiency and minimum physical strain for core drilling in the workshop and on the construction site.	High-performance, powerful and ingenious 3-speed automatic magnetic core drill with clockwise/anti-clockwise operation, MT3 tool mounting and fine adjustment offering maximum efficiency and minimum physical strain for core drilling in the workshop.	
<b>Page</b>	175	175	
<b>Application</b>	Core drilling in metal with a Ø up to 32 mm	▲▲	▲▲
	Core drilling in metal with a Ø up to 50 mm	▲▲	▲▲
	Core drilling in metal with a Ø up to 65 mm		▲▲
	Core drilling in metal with a Ø up to 80 mm		▲▲
	Twist drills with drill chuck (DIN 338)	▲	▲
	Twist drills with MK fitting (DIN 345)	▲▲	▲▲
	Tapping	▲▲	▲▲
	Countersinking	▲▲	▲▲
	Reaming	▲▲	▲▲
	Fully-automatic drilling	▲▲	▲▲
	Working one-handed	▲▲	▲▲
<b>Equipment</b>	Working overhead	▲	▲
	Installation work	▲▲	▲
	Workshop jobs	▲▲	▲▲
	Electronic magnetic holding force	●	●
	Magnetic holding force display	●	●
	Automatic drill feed	●	●
	Reversible rotation	●	●
	Variable speed control	●	●
	Memory function	●	●
	Speed-controlled electronics (tacho)	●	●
	Torque slipping clutch		●
<b>Technical features</b>	Carbide core drill bit max. Ø	50 mm	80 mm
	HSS core drill max. Ø	40 mm	65 mm
	Core drill, drilling depth max.	50(75)* mm	50 mm
	Twist drill max. Ø	18/23** mm	18/32** mm
	Tapping	M 16**	M 27**
	Countersinking max. Ø	50** mm	50** mm
	Reaming max. Ø	23** mm	31** mm
	Input	1 200 W	2 000 W
	Output	610 W	900 W
	Speed, full load		
	1st gear	130 - 260 1/min	110 - 180 1/min
	2nd gear	260 - 520 1/min	160 - 260 1/min
	3rd gear		350 - 580 1/min
	Core drill holder	QuickIN	QuickIN/QuickIN MAX
	Tool Holder	MK 3	MK 3
	Stroke	145 mm	145 mm
	Total stroke range	315 mm	285 mm
	Adjustment range for drill jigs		± 4,25 mm
	Swivel range for drill jigs		± 11°
	Magnetic holding power	12 500 N	18 000 N
Magnetic foot dimensions	195 x 90 mm	270 x 90 mm	
Cable with plug	4 m	4 m	
Weight according to EPTA	16,2 kg	26,4 kg	

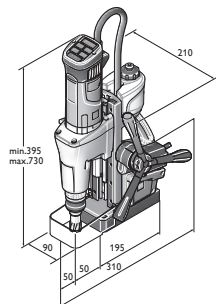

KBM 50 auto

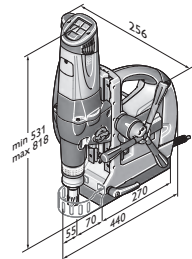

KBM 80 auto

- ▲ suitability
- ▲▲ optimal suitability
- included
- \* Also available with accessories.
- \*\* In manual tool mode only

**KBM 50 auto**

Lightweight, powerful and ingenious 2-speed auto magnetic core drill offering maximum efficiency and minimum physical strain for core drilling in the workshop and on the construction site.



For accessories, see page 165

Input	W	1 200
Output	W	610
1st gear	1/min	130 - 260
2nd gear	1/min	260 - 520
Tool Holder		MK 3
Twist drill max. Ø	mm	18/23**
Core drill, drilling depth max.	mm	50(75)*
Tapping		M 16**
Countersinking max. Ø	mm	50**
Reaming max. Ø	mm	23**
Carbide core drill bit max. Ø	mm	50
HSS core drill max. Ø	mm	40
Core drill holder		QuickIN
Stroke	mm	145
Total stroke range	mm	315
Magnetic holding power	N	12 500
Magnetic foot dimensions	mm	195 x 90
Cable with plug	m	4
Weight according to EPTA	kg	16,2
<b>Part number</b>		<b>7 270 42 61 00 0</b>
<b>EAN</b>		<b>4014586874272</b>
<b>Price in € [PC01]</b>		<b>2.088,45</b>

**FEIN benefits:**

- ▶ Saves time and money when producing a large number of holes thanks to the digitally controlled drill feed.
- ▶ Thanks to reproducible and timed drilling times, working hours for commissioned and serial work can be planned.
- ▶ Universal work, such as tapping in manual tool mode thanks to clockwise/anti-clockwise rotation and MT3 interface.
- ▶ FEIN high-power motor with stable speed.
- ▶ Electronic speed setting.
- ▶ High magnetic holding force.
- ▶ Convenient magnetic holding force display.
- ▶ Integrated coolant tank.
- ▶ Tilt sensor.
- ▶ Controls which can be clearly seen.
- ▶ \* Also available with accessories.
- ▶ \*\* In manual tool mode only

**Price includes:**

1 case, 1 coolant tank, 1 lashing strap, 1 swarf hook, 1 centering pin, 1 drift key, 1 contact guard

**KBM 80 auto**

High-performance, powerful and ingenious 3-speed automatic magnetic core drill with clockwise/anti-clockwise operation, MT3 tool mounting and fine adjustment offering maximum efficiency and minimum physical strain for core drilling in the workshop.



For accessories, see page 176

Input	W	2 000
Output	W	900
1st gear	1/min	110 - 180
2nd gear	1/min	160 - 260
3rd gear	1/min	350 - 580
Tool Holder		MK 3
Twist drill max. Ø	mm	18/32**
Core drill, drilling depth max.	mm	50
Tapping		M 27**
Countersinking max. Ø	mm	50**
Reaming max. Ø	mm	31**
Carbide core drill bit max. Ø	mm	80
HSS core drill max. Ø	mm	65
Core drill holder		QuickIN/ QuickIN MAX
Stroke	mm	145
Total stroke range	mm	285
Adjustment range for drill jigs	mm	± 4,25
Swivel range for drill jigs		± 11°
Magnetic holding power	N	18 000
Magnetic foot dimensions	mm	270 x 90
Cable with plug	m	4
Weight according to EPTA	kg	26,4
<b>Part number</b>		<b>7 270 32 00 23 0</b>
<b>EAN</b>		<b>4014586862538</b>
<b>Price in € [PC01]</b>		<b>3.640,35</b>

**FEIN benefits:**

- ▶ Saves time and money when producing a large number of holes thanks to the digitally controlled drill feed.
- ▶ Thanks to reproducible and timed drilling times, working hours for commissioned and serial work can be planned.
- ▶ Universal work, such as tapping in manual tool mode thanks to clockwise/anti-clockwise rotation and MT3 interface.
- ▶ FEIN high-power motor with stable speed.
- ▶ Electronic speed setting.
- ▶ High magnetic holding force.
- ▶ Convenient magnetic holding force display.
- ▶ Integrated coolant tank.
- ▶ Tilt sensor.
- ▶ Controls which can be clearly seen.
- ▶ Mechanical 3-speed gearbox.
- ▶ Automatic coolant supply.
- ▶ Slipping clutch torque.
- ▶ \*\* In manual tool mode only

**Price includes:**

1 case, 1 coolant tank, 1 lashing strap, 1 swarf hook, 2 centering pins, 1 contact guard, 1 drift key, 1 QuickIN MAX/ MT3 tool mounting



**Carbide core drill**



**TCT Ultra 50 core bit with QuickIN MAX holder**  
Very long service life and outstanding cutting performance.  
Metric dimensions, cutting depth 50 mm.

Bore Ø mm	Part number	Price in €
50	6 31 27 330 01 0	86,76
51	6 31 27 331 01 0	95,87
52	6 31 27 332 01 0	95,87
53	6 31 27 333 01 0	95,87
54	6 31 27 334 01 0	95,87
55	6 31 27 335 01 0	95,87
56	6 31 27 336 01 0	99,92
57	6 31 27 337 01 0	99,92
58	6 31 27 338 01 0	99,92
59	6 31 27 339 01 0	99,92
60	6 31 27 340 01 0	99,92
61	6 31 27 341 01 0	113,06
62	6 31 27 342 01 0	113,06
63	6 31 27 343 01 0	113,06
64	6 31 27 344 01 0	113,06
65	6 31 27 345 01 0	113,06
66	6 31 27 346 01 0	129,71
67	6 31 27 347 01 0	129,71
68	6 31 27 348 01 0	129,71
69	6 31 27 349 01 0	129,71
70	6 31 27 350 01 0	143,25
71	6 31 27 351 01 0	144,62
72	6 31 27 352 01 0	145,97
73	6 31 27 353 01 0	147,32
74	6 31 27 354 01 0	148,68
75	6 31 27 355 01 0	150,02
76	6 31 27 456 01 0	156,79
77	6 31 27 457 01 0	158,15
78	6 31 27 458 01 0	160,16
79	6 31 27 459 01 0	162,21
80	6 31 27 460 01 0	162,21

**Adapter/drill chuck**



**Adapter with QuickIN MAX holder**  
QuickIN output

Part number	Price in €
6 39 01 045 01 0	41,82



**Key-type drill chuck with QuickIN holder**

Chuck opening mm	Part number	Price in €
1.5 - 13	6 39 01 023 02 0	65,43
1 - 16	6 39 01 023 01 1	77,55

**MT 3 drive arbors**



**QuickIN output**  
For retrofitting KBM 80 U / KBM 80 auto. With integrated cooling lubricant supply. For all QuickIN core bits with a Ø of 12 - 65 mm.

Part number	Price in €
6 39 01 039 02 0	158,66



**QuickIN MAX output**  
For retrofitting KBM 80 U / KBM 80 auto. With integrated cooling lubricant supply. For all FEIN QuickIN MAX core bits with a Ø of 50-80 mm.

Part number	Price in €
6 39 01 038 02 0	232,46



**Weldon 32 Standard output**  
Specially designed for core bits with cutting surfaces offset by 90°. Maximum cutting depth 50 mm.

Part number	Price in €
6 39 01 041 01 0	269,34



**Weldon 32 output**  
Clamping surfaces in line. Maximum cutting depth 75 mm. Specially designed for core bits from:

Mount	Part number	Price in €
Hougen	6 39 01 042 01 0	269,34
Jancy	6 39 01 040 01 0	269,34



**Enlargement tapers**  
for M.T. sockets

Mount	Part number	Price in €
MT 3/MT 3	6 33 04 005 00 0	158,66

**Thread cutting KBM 80**



**Tapping rapid change chuck for KBM 80**  
can only be used for core drilling units with anti-clockwise rotation. Size 3, with QuickIN MAX holder, for thread drills (DIN 374/376), in conjunction with thread cutting inserts with or without M 22-M 27 safety clutch.

Part number	Price in €
9 26 02 082 01 0	355,57



**Tapping Inserts**  
for thread drills in accordance with DIN 374/376

Thread	Ø mm	Square mm	Part number	Price in €
M22/M24	18	14,5	6 32 06 119 01 0	158,66
M 27	20	16	6 32 06 120 01 0	158,66



**Tapping Inserts**  
with safety coupling for blind holes.  
for thread drills in accordance with DIN 374/376

Thread	Ø mm	Square mm	Part number	Price in €
M22/M24	18	14,5	6 32 06 122 01 0	330,84
M 27	20	16	6 32 06 123 01 0	330,84



**Interchangeable reducing insert (WRE 3/2)**  
Reducing insert for holding size 2 thread cutting inserts (M 6-M 20) in size 3 thread cutting quick change chuck. (9 26 02 082 01 0)

Part number	Price in €
6 32 06 125 01 0	195,55



**Clamping fixtures**



**Vacuum plate**  
for anti-magnetic materials and structured bases  
(corrugated sheet, stud plate etc.)  
396 x 350 x 95 mm for KBM 80 U, 80 auto.

Part number	Price in €
9 26 02 085 01 0	484,09



**Vacuum pump**  
Suction rate 0,015 m<sup>3</sup>/min, -0,8 bar, 92 W, weight 2,5 kg  
including suction hose

Part number	Price in €
9 26 01 022 01 3	499,09

**Cooling**



**Pump**  
Capacity approx. 450 ml. Suited to FEIN core drilling units  
KBM 32 Q, KBM 50 QX, KBM 52 U, KBM 65 Q, KBM 65 QF.

Part number	Price in €
3 21 32 022 00 7	9,59

**Replacement hose**  
for hand pump 3 21 32 022 00 7.

Part number	Price in €
3 14 14 054 00 8	3,14



**Flex-jointed hose**  
Suitable for KBM 50 Q, 50 U, 50 auto, 65 U when using twist  
drills.

Part number	Price in €
3 14 14 070 01 0	12,62



**Cutting spray**  
300 ml pump spray, for long tool life, optimum cutting  
performance and enhanced swarf flow.

Part number	Price in €
3 21 32 031 00 0	15,20



**Cutting paste**  
Lubricating agents for working on sheet metals.

Part number	Price in €
3 21 32 020 12 9	14,11

**Other accessories**



**Magbrush**  
Practical tool with high magnetic force for quick and easy  
collection of magnetic metal swarf.

Part number	Price in €
6 42 01 005 01 0	42,61



## A clean finish: FEIN Dustex.

Dust extractors from the FEIN Dustex range are the ideal solution for minimising dust when working with power tools in industrial settings, in the workshop, or for assembly jobs. The convenient automatic on/off function switches these professional and exceptionally quiet wet/dry dust extractors on and off via the switch on the connected power tool. FEIN Dustex dust extractors also feature a soft start function which reduces the start-up current to avoid unnecessarily tripping lower rated fuses. The dust extractors are supplied with an extra-long power cable and a suction hose, giving the user maximum range and flexibility. FEIN Dustex safety extractors can reliably remove class M hazardous dusts.



---

### Wet / dry dust extractor

Page 180

For clean results and safe,  
healthy working conditions.



		Dustex 25 L set	Dustex 25 L	Dustex 35 L set	Dustex 35 L	Dustex 35 LX	Dustex 35 LX AC	Dustex 35 MX	Dustex 35 MX AC
		Compact, powerful wet and dry dust extractor for connecting to power tools when working in the workshop and for assembly work, with large accessory set.	Compact, powerful wet and dry dust extractor for connecting to power tools when working in the workshop and for assembly work.	Powerful wet and dry dust extractor for connecting to power tools when working in the workshop and for assembly work, with large accessory set.	Powerful wet and dry dust extractor for connecting to power tools when working in the workshop and for assembly work.	Powerful, professional wet/dry dust extractor of dust class L for attachment of various case systems including extensive accessories.	Powerful, professional wet/dry dust extractor of dust class L with fully automatic filter cleaning for attachment of various case systems including extensive accessories.	Powerful, professional wet/dry dust extractor of dust class M for attachment of various case systems including extensive accessories.	Powerful, professional wet/dry dust extractor of dust class M with fully automatic filter cleaning for attachment of various case systems including extensive accessories.
<b>Page</b>		181	181	181	182	182	182	183	183
<b>Equipment</b>	Automatic start/stop	•	•	•	•	•	•	•	•
	Soft start	•	•	•	•	•	•	•	•
	Automatic filter cleaning						•		•
	Antistatic preparation						•	•	•
	Case storage						•	•	•
<b>Technical features</b>	Dust class	L	L	L	L	L	L	M	M
	Maximum power input	1 380 W	1 380 W	1 380 W	1 380 W	1 380 W	1 380 W	1 380 W	1 380 W
	Air flow	4 320 l/min	4 320 l/min	4 320 l/min	4 320 l/min	4 320 l/min	4 320 l/min	4 320 l/min	4 320 l/min
	Max. vacuum	253 hPa	253 hPa	253 hPa	253 hPa	254 hPa	254 hPa	254 hPa	254 hPa
	Tank volume	22 l	22 l	32 l	32 l	35 l	35 l	35 l	35 l
	Weight according to EPTA	8 kg	8 kg	9 kg	9 kg	13,5 kg	14,1 kg	13,5 kg	14,1 kg

• included

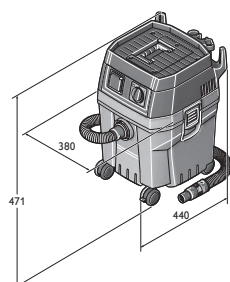

Dustex 25 L  
Dustex 25 L Set

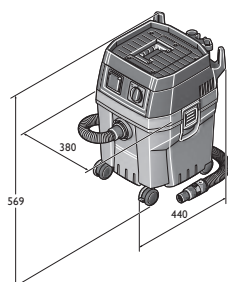

Dustex 35 L  
Dustex 35 L Set

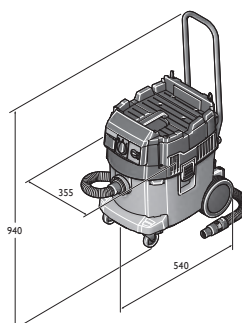

Dustex 35 LX  
Dustex 35 LX AC

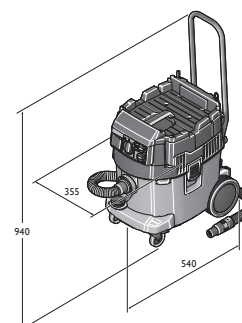

Dustex 35 MX  
Dustex 35 MX AC

**Dustex 25 L set**

Compact, powerful wet and dry dust extractor for connecting to power tools when working in the workshop and for assembly work, with large accessory set.



For accessories, see page 184

Maximum power input	W	1 380
Air flow	l/min	4 320
Max. vacuum	hPa	253
Tank volume	l	22
Cable with plug	m	6
Weight according to EPTA	kg	8
<b>Part number</b>	<b>9 20 27 060 00 0</b>	
<b>EAN</b>	<b>4014586878362</b>	
<b>Price in € [PC01]</b>	<b>313,95</b>	

**FEIN benefits:**

- ▶ Powerful turbine for 72 l/s volumetric flow and 253 mbar vacuum (240V).
- ▶ Low noise level of 67 dB (A).
- ▶ Large range thanks to 6 m power cable and 4 m suction hose.
- ▶ Large, 360° rotating castors for optimum manoeuvrability even in tight spaces.
- ▶ Tool collar with suction force regulation to set the suction power with ease.
- ▶ Auto start socket with switch-on delay to avoid power surges.
- ▶ Practical storage area with edge.
- ▶ Approval for dust class L.

**Price includes:**

1x 4 m suction hose, diameter 35 mm, 1 tool collar with suction force regulation, 1 Fleece filter bag, 1 Flat-fold filter, 2 suction pipes (metal), 1 combi nozzle with interchangeable inserts, 1 groove nozzle, 1 suction brush, 1 elbow

**Dustex 25 L**

Compact, powerful wet and dry dust extractor for connecting to power tools when working in the workshop and for assembly work.



For accessories, see page 184

Maximum power input	W	1 380
Air flow	l/min	4 320
Max. vacuum	hPa	253
Tank volume	l	22
Cable with plug	m	6
Weight according to EPTA	kg	8
<b>Part number</b>	<b>9 20 27 223 00 0</b>	
<b>EAN</b>	<b>4014586877365</b>	
<b>Price in € [PC01]</b>	<b>271,95</b>	

**FEIN benefits:**

- ▶ Powerful turbine for 72 l/s volumetric flow and 253 mbar vacuum (240V).
- ▶ Low noise level of 67 dB (A).
- ▶ Large range thanks to 6 m power cable and 4 m suction hose.
- ▶ Large, 360° rotating castors for optimum manoeuvrability even in tight spaces.
- ▶ Tool collar with suction force regulation to set the suction power with ease.
- ▶ Auto start socket with switch-on delay to avoid power surges.
- ▶ Practical storage area with edge.
- ▶ Approval for dust class L.

**Price includes:**

1x 4 m suction hose, diameter 35 mm, 1 tool collar with suction force regulation, 1 Fleece filter bag, 1 Flat-fold filter

**Dustex 35 L set**

Powerful wet and dry dust extractor for connecting to power tools when working in the workshop and for assembly work, with large accessory set.



For accessories, see page 184

Maximum power input	W	1 380
Air flow	l/min	4 320
Max. vacuum	hPa	253
Tank volume	l	32
Cable with plug	m	6
Weight according to EPTA	kg	9
<b>Part number</b>	<b>9 20 28 060 00 0</b>	
<b>EAN</b>	<b>4014586878423</b>	
<b>Price in € [PC01]</b>	<b>360,15</b>	

**FEIN benefits:**

- ▶ Powerful turbine for 72 l/s volumetric flow and 253 mbar vacuum (240V).
- ▶ Low noise level of 67 dB (A).
- ▶ Large range thanks to 6 m power cable and 4 m suction hose.
- ▶ Large, 360° rotating castors for optimum manoeuvrability even in tight spaces.
- ▶ Tool collar with suction force regulation to set the suction power with ease.
- ▶ Auto start socket with switch-on delay to avoid power surges.
- ▶ Practical storage area with edge.
- ▶ Approval for dust class L.

**Price includes:**

1 tool collar with suction force regulation, 1 combi nozzle with interchangeable inserts, 1x 4 m suction hose, diameter 35 mm, 1 suction brush, 1 elbow, 2 suction pipes (metal), 1 groove nozzle, 1 Flat-fold filter, 1 Fleece filter bag



**Dustex 35 L**

Powerful wet and dry dust extractor for connecting power tools when working in the workshop and for assembly work.



For accessories, see page 184

Maximum power input	W	1 380
Air flow	l/min	4 320
Max. vacuum	hPa	253
Tank volume	l	32
Cable with plug	m	6
Weight according to EPTA	kg	9
<b>Part number</b>	<b>9 20 28 223 00 0</b>	
<b>EAN</b>	<b>4014586877389</b>	
<b>Price in € [PC01]</b>	<b>316,05</b>	

**FEIN benefits:**

- ▶ Powerful turbine for 72 l/s volumetric flow and 253 mbar vacuum (240V).
- ▶ Low noise level of 67 dB (A).
- ▶ Large range thanks to 6 m power cable and 4 m suction hose.
- ▶ Large, 360° rotating castors for optimum manoeuvrability even in tight spaces.
- ▶ Auto start socket with switch-on delay to avoid power surges.
- ▶ Approval for dust class L.
- ▶ Practical storage area with edge.
- ▶ Tool collar with suction force regulation to set the suction power with ease.

**Price includes:**

1x 4 m suction hose, diameter 35 mm, 1 tool collar with suction force regulation, 1 Fleece filter bag, 1 Flat-fold filter

**Dustex 35 LX**

Powerful, professional wet/dry dust extractor of dust class L for attachment of various case systems including extensive accessories.



For accessories, see page 184

Maximum power input	W	1 380
Air flow	l/min	4 320
Max. vacuum	hPa	254
Tank volume	l	35
Cable with plug	m	7,5
Sound pressure level	dB	67
Weight according to EPTA	kg	13,5
<b>Part number</b>	<b>9 20 29 060 00 0</b>	
<b>EAN</b>	<b>4014586882956</b>	
<b>Price in € [PC01]</b>	<b>480,90</b>	

**FEIN benefits:**

- ▶ Tool cases of various systems can be simply positioned on the extraction head and secured.
- ▶ Ergonomic transport of the complete unit, including power tool and extractor, thanks to push bar and case and accessory attachment.
- ▶ Reliable suction of different types of dirt from liquids to fine dusts.
- ▶ Approval for dust class L.
- ▶ With PES flat fold filter and electronic shut-off for outstanding wet extraction performance.
- ▶ Auto start socket with switch-on delay to avoid power surges.
- ▶ The 7.5 m mains cable and 4 m hose provide a large working radius.

**Price includes:**

1 push bar, 1 PES flat fold filter, 1 premium fleece filter bag, 1x 4 m suction hose, diameter 35 mm, 1 tool collar with suction force regulation, 1 stepped collar, 2 suction pipes (metal), 1 combi nozzle with interchangeable inserts, 1 crevice nozzle, 1 suction brush, 1 elbow

**Dustex 35 LX AC**

Powerful, professional wet/dry dust extractor of dust class L with fully automatic filter cleaning for attachment of various case systems including extensive accessories.



For accessories, see page 184

Maximum power input	W	1 380
Air flow	l/min	4 320
Max. vacuum	hPa	254
Tank volume	l	35
Cable with plug	m	7,5
Sound pressure level	dB	67
Weight according to EPTA	kg	14,1
<b>Part number</b>	<b>9 20 30 060 00 0</b>	
<b>EAN</b>	<b>4014586882994</b>	
<b>Price in € [PC01]</b>	<b>588,00</b>	

**FEIN benefits:**

- ▶ Tool cases of various systems can be simply positioned on the extraction head and secured.
- ▶ Ergonomic transport of the complete unit, including power tool and extractor, thanks to push bar and case and accessory attachment.
- ▶ Fully automatic filter cleaning (AC) makes the flat fold filter last longer for uninterrupted working.
- ▶ Reliable suction of different types of dirt from liquids to fine dusts.
- ▶ Approval for dust class L.
- ▶ With PES flat fold filter and electronic shut-off for outstanding wet extraction performance.
- ▶ Auto start socket with switch-on delay to avoid power surges.
- ▶ The 7.5 m mains cable and 4 m hose provide a large working radius.

**Price includes:**

1 push bar, 1 PES flat fold filter, 1 disposal bag, 1x 4 m suction hose, diameter 35 mm, 1 tool collar with suction force regulation, 1 stepped collar, 2 suction pipes (metal), 1 combi nozzle with interchangeable inserts, 1 crevice nozzle, 1 suction brush, 1 elbow



**Dustex 35 MX**

Powerful, professional wet/dry dust extractor of dust class M for attachment of various case systems including extensive accessories.



For accessories, see page 184

Maximum power input	W	1 380
Air flow	l/min	4 320
Max. vacuum	hPa	254
Tank volume	l	35
Cable with plug	m	7,5
Sound pressure level	dB	67
Weight according to EPTA	kg	13,5
<b>Part number</b>		<b>9 20 31 060 00 0</b>
<b>EAN</b>		<b>4014586883052</b>
<b>Price in € [PC01]</b>		<b>637,35</b>

**FEIN benefits:**

- ▶ Approved for holding hazardous dusts of class M.
- ▶ Tool cases of various systems can be simply positioned on the extraction head and secured.
- ▶ Ergonomic transport of the complete unit, including power tool and extractor, thanks to push bar and case and accessory attachment.
- ▶ Reliable suction of different types of dirt from liquids to fine dusts.
- ▶ With PES flat fold filter and electronic shut-off for outstanding wet extraction performance.
- ▶ Auto start socket with switch-on delay to avoid power surges.
- ▶ The 7.5 m mains cable and 4 m hose provide a large working radius.

**Price includes:**

1 push bar, 1 PES flat fold filter, 1 premium fleece filter bag, 1x 4 m ES suction hose, diameter 35 mm, 1 tool collar with suction force regulation, 1 stepped collar, 2 suction pipes (metal), 1 combi nozzle with interchangeable inserts, 1 crevice nozzle, 1 suction brush, 1 elbow

**Dustex 35 MX AC**

Powerful, professional wet/dry dust extractor of dust class M with fully automatic filter cleaning for attachment of various case systems including extensive accessories.



For accessories, see page 184

Maximum power input	W	1 380
Air flow	l/min	4 320
Max. vacuum	hPa	254
Tank volume	l	35
Cable with plug	m	7,5
Sound pressure level	dB	67
Weight according to EPTA	kg	14,1
<b>Part number</b>		<b>9 20 32 060 00 0</b>
<b>EAN</b>		<b>4014586883069</b>
<b>Price in € [PC01]</b>		<b>733,95</b>

**FEIN benefits:**

- ▶ Approved for holding hazardous dusts of class M.
- ▶ Tool cases of various systems can be simply positioned on the extraction head and secured.
- ▶ Fully automatic filter cleaning (AC) makes the flat fold filter last longer for uninterrupted working.
- ▶ Ergonomic transport of the complete unit, including power tool and extractor, thanks to push bar and case and accessory attachment.
- ▶ Reliable suction of different types of dirt from liquids to fine dusts.
- ▶ With PES flat fold filter and electronic shut-off for outstanding wet extraction performance.
- ▶ Auto start socket with switch-on delay to avoid power surges.
- ▶ The 7.5 m mains cable and 4 m hose provide a large working radius.

**Price includes:**

1 push bar, 1 PES flat fold filter, 1 disposal bag, 1x 4 m ES suction hose, diameter 35 mm, 1 tool collar with suction force regulation, 1 stepped collar, 2 suction pipes (metal), 1 combi nozzle with interchangeable inserts, 1 crevice nozzle, 1 suction brush, 1 elbow

**General accessories**

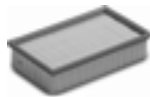

**Flat-fold filter**  
Cellulose, M dust class certification

Part number	Price in €
3 13 45 012 01 0	27,31



**Flat-fold filter**  
PES, M dust class certification, superior filter

Part number	Price in €
3 13 45 059 01 0	52,48



**Flat-fold filter**  
HEPA

Part number	Price in €
3 13 45 060 01 0	85,25



**Suction hose**

Ø mm	L m	Part number	Price in €
27	4	3 13 45 065 01 0	68,54
35	4	3 13 45 066 01 0	56,76



**Suction hose**  
Electrostatically discharging, orange-black.

Ø mm	L m	Part number	Price in €
27	4	3 13 45 121 01 0	138,16
35	4	3 13 45 120 01 0	159,58



**Extension hose**

Ø mm	L m	Part number	Price in €
27	2,5	3 13 45 067 01 0	63,19
35	2,5	3 13 45 068 01 0	51,41



**Repair set**  
Suitable for 35 mm diameter suction hose

Part number	Price in €
3 13 45 069 01 0	27,31



**Elbow**

Part number	Price in €
3 13 45 070 01 0	11,46



**Elbow**  
with leak air aperture.

Ø mm	Part number	Price in €
35	3 13 45 263 01 0	17,03



**Suction tube**  
Metal version, pack of 2

Part number	Price in €
3 13 45 071 01 0	27,31



**Floor nozzle**  
Reversible, with stainless steel sliding surface and all-round bristles. Suitable for hard floors and textile floor coverings

Part number	Price in €
3 13 45 072 01 0	34,91



**Combination nozzle**  
For wet and dry work with interchangeable inserts, rubber lips and brush strips

Part number	Price in €
3 13 45 073 01 0	32,77



**Aluminium combi nozzle**  
For wet and dry work with interchangeable inserts, rubber lips and brush strips

Part number	Price in €
3 13 45 137 01 0	101,75



**Crevice nozzle**

Part number	Price in €
3 13 45 074 01 0	5,46



**Upholstery nozzle**  
With brush strips

Part number	Price in €
3 13 45 075 01 0	8,24



**Suction brush,**  
can be rotated, with natural bristles, 70 x 45 mm bristle area

Part number	Price in €
3 13 45 076 01 0	10,38



**Intake brush**  
Natural bristles, 120 x 45 mm bristle area

Part number	Price in €
3 13 45 077 01 0	16,39

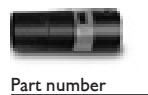

**Tool collar with suction force regulation**  
38 mm diameter, power tool side

Part number	Price in €
3 13 45 123 01 0	26,78



**Tool collar with suction force regulation**  
Electrically conducting, diameter 27 mm, power tool side.

Part number	Price in €
3 13 45 250 01 0	24,58



**Stepped collar**  
4 levels

Part number	Price in €
3 13 45 079 01 0	10,38



**Cable holder**  
to guide cable on suction hose, suitable for suction hose diameter of 27-35 mm

No. in pack pcs	Part number	Price in €
5	3 13 45 119 01 0	6,43

**Accessory set**

2 suction pipes (metal), 1 combi nozzle with interchangeable inserts, 1 crevice nozzle, 1 suction brush, 1 elbow

Part number	Price in €
3 13 45 071 02 0	73,90

**Accessory set**

1 suction hose, 2 suction pipes (metal), 1 combi nozzle with interchangeable inserts, 1 crevice nozzle, 1 suction brush, 1 elbow

Ø mm	Part number	Price in €
40	3 13 45 133 02 0	77,11

**Accessories for Dustex 35 LX / MX****Disposal bag**

Open, recommended for AC models only

No. in pack pcs	Part number	Price in €
5	3 13 45 063 01 0	31,06

**Premium fleece filter bag**

Reinforced material and seams for fine and abrasive dusts.

No. in pack pcs	Part number	Price in €
5	3 13 45 251 01 0	45,79

**Accessories for FEIN Dustex 35 L****Fleece filter bag**

No. in pack pcs	Part number	Price in €
5	3 13 45 062 01 0	28,38

**Premium fleece filter bag**

Reinforced material and seams for fine and abrasive dusts.

No. in pack pcs	Part number	Price in €
5	3 13 45 251 01 0	45,79

**Permanent filter**

Replaces the fleece filter bag

Part number	Price in €
3 13 45 064 01 0	53,55

**HEPA filter bag**

No. in pack pcs	Part number	Price in €
3	3 13 45 130 01 0	94,25

**Accessories for FEIN Dustex 25 L****Fleece filter bag**

No. in pack pcs	Part number	Price in €
5	3 13 45 061 01 0	21,85

**Permanent filter**

Replaces the fleece filter bag

Part number	Price in €
3 13 45 064 01 0	53,55

**Accessories for Dustex II, Dustex 25, Dustex 40****Filter bag**

Extra fine version for higher levels of material separation, pack of 5

Model	Part number	Price in €
Dustex II, 25	3 13 22 757 01 6	39,18
Dustex 40	3 13 22 811 01 0	85,24

**Filter bag**

Standard version, pack of 5

Model	Part number	Price in €
Dustex II, 25	3 13 22 781 01 7	22,94
Dustex 40	3 13 22 810 01 0	41,79

**Filter cartridge**

Part number	Price in €
3 13 22 765 00 9	52,44

**Suction hose**

Ø 36 mm, length 5 m

Part number	Price in €
3 13 22 767 01 5	45,89

**Connecting piece**

Universal device to connect power tools and accessories with dust extraction to vacuum cleaner. Flexible rubber sleeve, length 70 mm, inner diameter 31.5 mm.

Part number	Price in €
3 13 22 771 00 9	4,91

**Stepped collar**

for various connection diameters, e.g. for connecting up equipment from other manufacturers.

Part number	Price in €
3 13 22 772 00 2	9,83



# Outstanding surface finishes for stainless steel, wood and paint.

When it comes to surface processing, only one factor counts: flawless results. Whether you're sanding or polishing, with the extensive range of FEIN power tools and specially designed professional sets you are in the best possible position to satisfy the exact specified requirements in surface finish. This is equally true for stainless steel machining, woodworking, interior fitting, renovation, vehicle or boat repairs and special vehicle construction. FEIN is the name you can count on: with powerful, virtually indestructible power tools, excellent ergonomics for minimum fatigue and maximum efficiency, and practical accessories – for perfect results. You will find more surface processing products in the chapters on Oscillation and Stationary Belt Grinders.



---

## Sanders

**Page****188**

The perfect tools for rough sanding and fine sanding of surfaces, pipes and profiles.

---

## Polishers

**Page****202**

Protecting and caring for sensitive and high-quality surfaces.



	MSf 636-1	RS 12-70 E	RS 12-70 E - Professional stainless steel set	WPO 14-25 E	WPO 14-25 E - Stainless steel Start set	
	Extremely powerful eccentric sander with optimum dust extraction for all surfaces.	Pipe sander with extremely high sanding capacity for stainless steel pipes and pipe bends up to 80 mm in diameter.	Stainless steel starter set for standard applications in pipe machining.	Extremely powerful sander/polisher for cool machining of stainless steel surfaces.	Stainless steel starter set for standard applications in surface machining.	
Page	190	190	190	191	191	
Application	Rough sanding	▲▲	▲▲	▲▲	▲▲	
	Fine sanding	▲▲	▲▲	▲▲	▲▲	
	Dry sanding	▲▲	▲▲	▲▲	▲▲	
	Micro-sanding	▲▲	▲▲	▲▲	▲▲	
	polishing	▲	▲▲	▲▲	▲▲	
Equipment	FEIN high-power motor		●	●	●	
	Suction	●				
	Spindle lock				●	
	Restart protection		●	●	●	
Soft start		●	●	●	●	
Technical features	Input	380 W	1 200 W	1 200 W	1 200 W	1 200 W
	Speed, no load	8 800 1/min	2 700 - 7 000 1/min	2 700 - 7 000 1/min	900 - 2 500 1/min	900 - 2 500 1/min
	Weight according to EPTA	2,4 kg	3,8 kg	3,8 kg	2,5 kg	2,5 kg
	Polishing disc Ø	150 mm			230 mm	230 mm
	Sanding pad Ø	150 mm			230 mm	230 mm
	Mounting thread	5/16"			M 14	M 14
	Belt speed		22 m/sek	22 m/sek		
	Pipes up to Ø		8 - 80 mm	8 - 80 mm		

▲ suitability    ▲▲ optimal suitability    ● included

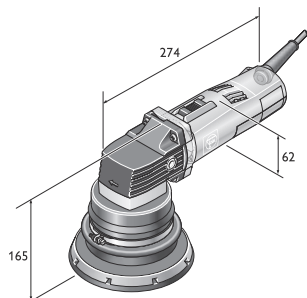

MSf 636-1

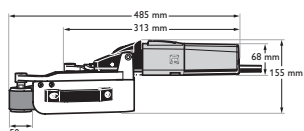

RS 12-70 E

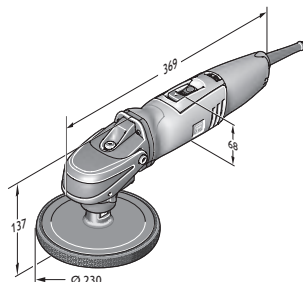

WPO 14-25 E



RS 10-70 E



	<b>ROT 14-200 E</b>	<b>RS 10-70 E Start set</b>	<b>KS 10-38 E set</b>	<b>WSG 17-70 Inox Start set</b>	<b>BF 10-280 E</b>	<b>BF 10-280 E Start set</b>
	Extremely powerful rotary sander for high material removal on metal, wood, coatings and fibreglass-reinforced plastics (FRP).	Handy, compact pipe sander for stainless steel pipes with a diameter of up to Ø 45 mm.	Fillet weld grinder for difficult-to-reach spots in metal constructions.	Stainless steel starter set for preparing to finish surfaces, pipes and profiles.	Extremely powerful belt file for corners and edges in stainless steel machining.	Start set belt file for corners and edges in stainless steel machining.
	191	192	192	192	193	193
	▲▲	▲▲	▲▲	▲▲	▲▲	▲▲
	▲▲	▲▲	▲▲	▲▲	▲▲	▲▲
	▲	▲▲	▲▲	▲▲	▲▲	▲▲
	●	●	●	●	●	●
	●			●		
	●	●	●	●	●	●
	●	●	●	●	●	●
	1 200 W	800 W	800 W	1 700 W	800 W	800 W
	900 - 2 500 1/min	2 500 - 7 000 1/min	1 350 - 3 750 1/min	2 700 - 8 500 1/min	10 000 - 28 000 1/min	10 000 - 28 000 1/min
	2,6 kg	2,9 kg	3,2 kg	2,4 kg	2,1 kg	2,1 kg
	200 mm			125 mm		
	200 mm			125 mm		
	M 14			M 14		
		3,5 - 11 m/sek			12 - 32 m/sek	12 - 32 m/sek
		8 - 45 mm				

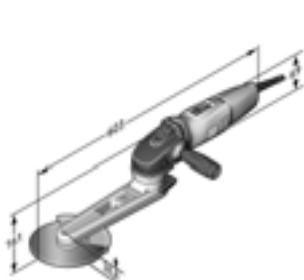

KS 10-38 E Set

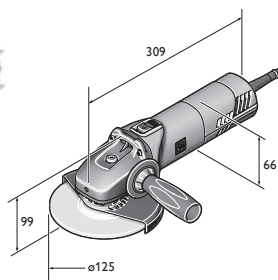

WSG 17-70

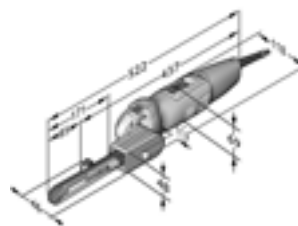

BF 10-280 E



**MSf 636-1**

Extremely powerful eccentric sander with optimum dust extraction for all surfaces.



For accessories, see page 194

Input	W	380
Speed, no load	1/min	8 800
Sanding pad Ø	mm	150
Polishing disc Ø	mm	150
Hose connection Ø	mm	32
Connector thread backing pad		5/16"-24 UNF
Mounting thread		5/16"
Stroke	mm	8,4
Cable with plug	m	5
Weight according to EPTA	kg	2,4
<b>Part number</b>	<b>7 220 78 00 22 5</b>	
<b>EAN</b>	<b>4014586811260</b>	
<b>Price in € [PC01]</b>	<b>576,45</b>	

**FEIN benefits:**

- ▶ Extra strong eccentric stroke means excellent sanding capacity for surfaces large or small.
- ▶ Hole pattern on sanding sheets, backing pad and pad edge makes for perfect dust extraction.
- ▶ Optimum finishing results for high-quality paints, fibreglass, wood, mineral substances (e.g. corian), plastic and metal.
- ▶ Slimline motor for good handling.
- ▶ Durable metal gear head.
- ▶ Sanding sheets with hook and loop fastening.
- ▶ Carbon brushes with self cut-off function.
- ▶ Wide range of accessories.

**Price includes:**

1 eccentric head Ø 150 mm, 1 backing pad, medium, Ø 150 mm, 1 suction wheel guard, 1 set of keys

**RS 12-70 E**

Pipe sander with extremely high sanding capacity for stainless steel pipes and pipe bends up to 80 mm in diameter.



For accessories, see page 194

Input	W	1 200
Output	W	750
Speed, no load	1/min	2 700 - 7 000
Minimum wall clearance	mm	50
Belt speed	m/sek	22
Pipes up to Ø	mm	8 - 80
Cable with plug	m	4
Weight according to EPTA	kg	3,8
<b>Part number</b>	<b>7 221 13 50 01 4</b>	
<b>EAN</b>	<b>4014586853819</b>	
<b>Price in € [PC01]</b>	<b>1.132,95</b>	

**FEIN benefits:**

- ▶ Effective sanding of welded seams thanks to optimum cutting speeds of the sanding belts.
- ▶ Infinitely variable speed for sanding, satin-finishing and high-gloss polishing of ready-fitted hand rails.
- ▶ Flexible sanding belts optimally adapt to even narrow pipe bends, creating surfaces without awkward transitions.
- ▶ 360° peripheral sanding in just 2 steps.
- ▶ Optional guide pulleys for narrow distances from the wall.
- ▶ Restart protection.
- ▶ Wide range of accessories.
- ▶ Dustproof ball bearing.
- ▶ Carbon brushes with self cut-off function.

**RS 12-70 E –**

**Professional stainless steel set**

Stainless steel starter set for standard applications in pipe machining.



For accessories, see page 194

Input	W	1 200
Output	W	750
Speed, no load	1/min	2 700 - 7 000
Minimum wall clearance	mm	50
Belt speed	m/sek	22
Pipes up to Ø	mm	8 - 80
Cable with plug	m	4
Weight according to EPTA	kg	3,8
<b>Part number</b>	<b>7 221 13 51 01 3</b>	
<b>EAN</b>	<b>4014586853826</b>	
<b>Price in € [PC01]</b>	<b>1.332,45</b>	

**FEIN benefits:**

- ▶ Effective sanding of welded seams thanks to optimum cutting speeds of the sanding belts.
- ▶ Infinitely variable speed for sanding, satin-finishing and high-gloss polishing of ready-fitted hand rails.
- ▶ Flexible sanding belts optimally adapt to even narrow pipe bends, creating surfaces without awkward transitions.
- ▶ 360° peripheral sanding in just 2 steps.
- ▶ Optional guide pulleys for narrow distances from the wall.
- ▶ Restart protection.
- ▶ Wide range of accessories.
- ▶ Dustproof ball bearing.
- ▶ Carbon brushes with self cut-off function.

**Price includes:**

2 x 10 pcs. polishing belts, 20 x 815 mm P120/P180, 2 x 10 pcs. polishing belts, 40 x 815 mm P120/P180, 5 fleece belts 20 x 820 mm very fine, 1 plastic carrying case

**WPO 14-25 E**

Extremely powerful sander/polisher for cool machining of stainless steel surfaces.



For accessories, see page 194

Input	W	1 200
Output	W	750
Speed, no load	1/min	900 - 2 500
Sanding pad Ø	mm	230
Polishing disc Ø	mm	230
Mounting thread		M 14
Cable with plug	m	4
Weight according to EPTA	kg	2,5
<b>Part number</b>		<b>7 221 49 00 23 0</b>
<b>EAN</b>		<b>4014586862729</b>
<b>Price in € [PC01]</b>		<b>418,95</b>

**FEIN benefits:**

- ▶ Extremely powerful even at low speeds thanks to mechanical gear reduction and FEIN high power motor.
- ▶ Infinitely variable speed, ideal for sanding, satin finishing, brushing and high-gloss polishing of stainless steel.
- ▶ Universal suitability as fully-functional sander, polisher and satin-finisher.
- ▶ Excellent handling.
- ▶ Spindle lock.
- ▶ Right or left-handed operation.
- ▶ Restart protection.
- ▶ Soft start.
- ▶ H 07 industrial cable.
- ▶ Dustproof ball bearing.
- ▶ Carbon brushes with self cut-off function.
- ▶ Comprehensive range of accessories available.

**Price includes:**

1 anti-vibration handle

**WPO 14-25 E - Stainless steel  
Start set**

Stainless steel starter set for standard applications in surface machining.



For accessories, see page 194

Input	W	1 200
Output	W	750
Speed, no load	1/min	900 - 2 500
Sanding pad Ø	mm	230
Polishing disc Ø	mm	230
Mounting thread		M 14
Cable with plug	m	4
Weight according to EPTA	kg	2,5
<b>Part number</b>		<b>7 221 49 50 01 0</b>
<b>EAN</b>		<b>4014586862743</b>
<b>Price in € [PC01]</b>		<b>719,25</b>

**FEIN benefits:**

- ▶ Extremely powerful even at low speeds thanks to mechanical gear reduction and FEIN high power motor.
- ▶ Infinitely variable speed, ideal for sanding, satin finishing, brushing and high-gloss polishing of stainless steel.
- ▶ Universal suitability as fully-functional sander, polisher and satin-finisher.
- ▶ Excellent handling.
- ▶ Spindle lock.
- ▶ Right or left-handed operation.
- ▶ Restart protection.
- ▶ Soft start.
- ▶ H 07 industrial cable.
- ▶ Dustproof ball bearing.
- ▶ Carbon brushes with self cut-off function.
- ▶ Comprehensive range of accessories available.

**Price includes:**

1 FEIN angle polisher WPO 14-25 E in plastic tool case, 1 holder, rotating, safety guard, 1 work arbour, 1 corrugated sanding fleece, 1 supporting plate with velcro adhesion section (Ø 115 mm, M14), 10 sanding fleeces with velcro (Ø 115 mm, fine), 1 elastic sanding roller (100 x 100 mm, grain 60), 1 lamella fleece cylinder (100 x 100 mm, grain 180), 2 keys, 1 anti-vibration handle

**ROT 14-200 E**

Extremely powerful rotary sander for high material removal on metal, wood, coatings and fibreglass-reinforced plastics (FRP).



For accessories, see page 194

Input	W	1 200
Output	W	750
Speed, no load	1/min	900 - 2 500
Sanding pad Ø	mm	200
Polishing disc Ø	mm	200
Hose connection Ø	mm	38
Mounting thread		M 14
Cable with plug	m	4
Weight according to EPTA	kg	2,6
<b>Part number</b>		<b>7 221 65 50 01 0</b>
<b>EAN</b>		<b>4014586867236</b>
<b>Price in € [PC01]</b>		<b>568,05</b>

**FEIN benefits:**

- ▶ 200 mm backing pad - extremely powerful across the entire speed range.
- ▶ Dust-free working with extractor hood, suitable for 150 and 200 mm backing pad.
- ▶ Double gear reduction ensures constant speeds even under the highest loads.
- ▶ Can be combined with the vacuum cleaners from the FEIN Dustex range.
- ▶ Can be used universally as a grinder and polisher.
- ▶ Infinitely variable speed, ideal for protecting sensitive surfaces.
- ▶ Excellent handling.
- ▶ Spindle lock.
- ▶ With mounted handle cover for optimum grip when polishing.
- ▶ Right or left-handed operation.
- ▶ Restart protection.
- ▶ H 07 industrial cable.
- ▶ Dustproof ball bearing.
- ▶ Extremely light weight.
- ▶ Large tool case for consumable material and accessories.

**Price includes:**

1 FEIN angle polisher WPO 14-25 E in plastic tool case, 1 Extractor hood, 1 backing pad, hard, Ø 200 mm, 1 anti-vibration handle

**RS 10-70 E Start set**

Handy, compact pipe sander for stainless steel pipes with a diameter of up to Ø 45 mm.



For accessories, see page 194

Input	W	800
Output	W	550
Speed, no load	1/min	2 500 - 7 000
Minimum wall clearance	mm	50
Belt speed	m/sek	3,5 - 11
Pipes up to Ø	mm	8 - 45
Cable with plug	m	4
Weight according to EPTA	kg	2,9
<b>Part number</b>		<b>7 221 66 60 00 0</b>
<b>EAN</b>		<b>4014586867519</b>
<b>Price in € [PC01]</b>		<b>1.090,95</b>

**FEIN benefits:**

- ▶ FEIN high-power motor for constant speed even when loaded.
- ▶ Optimum belt speeds for effective use of various grinding, fleece and polishing belts.
- ▶ Extremely easy to use - grinding arm can be swivelled, tool-free belt installation and adjustment.
- ▶ Automatic belt adjustment.
- ▶ Perfect belt guidance.
- ▶ Clasping angle of up to 180°.
- ▶ Infinitely variable speed, ideal for protecting sensitive surfaces.
- ▶ Soft start.
- ▶ Restart protection.
- ▶ H 07 industrial cable.
- ▶ Comprehensive range of accessories available.

**Price includes:**

1 pipe sander RS 10-70 E in plastic tool case, 10 each of grinding belts (grit 120, 180), 5 fleece belts (fine)

**KS 10-38 E set**

Fillet weld grinder for difficult-to-reach spots in metal constructions.



For accessories, see page 194

Input	W	800
Speed, no load	1/min	1 350 - 3 750
Peripheral speed	m/sec	29,5
Tool diameter	mm	150
Cable with plug	m	4
Weight according to EPTA	kg	3,2
<b>Part number</b>		<b>7 221 67 60 00 0</b>
<b>EAN</b>		<b>4014586868936</b>
<b>Price in € [PC01]</b>		<b>740,25</b>

**FEIN benefits:**

- ▶ Flexible use thanks to drive head that can be swivelled without the need for tools.
- ▶ Flat design for corners, angles and difficult-to-reach spots.
- ▶ Long belt drive service life thanks to zero-maintenance tensioning system.
- ▶ Spindle brake for quick tool changes.
- ▶ Spark hood can be adjusted and removed without the need for tools.
- ▶ Electronic speed setting.
- ▶ Made in Germany quality.
- ▶ H 07 industrial cable.
- ▶ Soft start.
- ▶ Restart protection.

**Price includes:**

1 fillet weld sander KS 10-38 E in plastic case, 1 anti-vibration handle, Medium fleece discs, diameter 150 mm, one 3 mm thick and one 6 mm thick, Fine fleece discs, diameter 150 mm, one 3 mm thick and one 6 mm thick, Profiling stone for profiling the fleece discs

**WSG 17-70 Inox Start set**

Stainless steel starter set for preparing to finish surfaces, pipes and profiles.



For accessories, see page 194

Input	W	1 700
Output	W	1 000
Speed, no load	1/min	2 700 - 8 500
Sanding pad Ø	mm	125
Polishing disc Ø	mm	125
Mounting thread		M 14
Cable with plug	m	4
Weight according to EPTA	kg	2,4
<b>Part number</b>		<b>7 222 13 61 00 0</b>
<b>EAN</b>		<b>4014586883564</b>
<b>Price in € [PC19]</b>		<b>413,70</b>

**FEIN benefits:**

- ▶ POWERtronic for enormous power, power reserve and exceptional speed stability under load.
- ▶ Variable speed allows various tools to be used for applications ranging from satin-finishing to sanding stainless steel.
- ▶ Longer carbon brush life and tool removes more material than comparable angle grinders.
- ▶ Industrial cable H07, length 4m.
- ▶ The best vibration performance in its class.
- ▶ Restart protection.
- ▶ Solid metal gearbox head for maximum robustness and service life.
- ▶ Electronic overload protection.
- ▶ Blockage monitoring.
- ▶ The lightest and shortest model of its kind.
- ▶ Soft start.

**Price includes:**

1 FEIN compact angle grinder WSG 17-70 Inox in plastic tool case, 1 serrated sanding disc, medium, 1 finishing disc (diameter 125 mm), 5 each of Pyramix sanding sheet, perforated, diameter 115 mm (grit 280, 400, 800), 25 sanding sheets (grit 80, diameter 115 mm), 1 cooling backing pad (diameter 75 mm, M14), 1 supporting plate with velcro adhesion section (Ø 115 mm, M14)



**BF 10-280 E**

Extremely powerful belt file for corners and edges in stainless steel machining.



For accessories, see page 194

Input	W	800
Output	W	550
Speed, no load	1/min	10 000 - 28 000
Belt speed	m/sek	12 - 32
Belt size	mm	520 x 3/6/20
Cable with plug	m	4
Weight according to EPTA	kg	2,1
<b>Part number</b>	<b>7 228 05 50 00 0</b>	
<b>EAN</b>	<b>4014586867250</b>	
<b>Price in € [PC01]</b>	<b>514,50</b>	

**FEIN benefits:**

- ▶ FEIN high-power motor for highly effective material removal and constant speed even at high loads.
- ▶ Optimum belt speeds for effective use of various grinding, fleece and polishing belts.
- ▶ Extremely easy to handle - tool-free, grinding arm can be swivelled 180°, tool-free belt installation and adjustment.
- ▶ Perfect belt guidance.
- ▶ Belt widths of between 3 and 20 mm.
- ▶ Infinitely variable speed, ideal for protecting sensitive surfaces.
- ▶ Stepped and straight grinding arms for a variety of applications.
- ▶ Soft start.
- ▶ Restart protection.
- ▶ H 07 industrial cable.
- ▶ Comprehensive range of accessories available.

**Price includes:**

1 stepped grinding arm

**BF 10-280 E Start set**

Start set belt file for corners and edges in stainless steel machining.



For accessories, see page 194

Input	W	800
Output	W	550
Speed, no load	1/min	10 000 - 28 000
Belt speed	m/sek	12 - 32
Belt size	mm	520 x 3/6/20
Cable with plug	m	4
Weight according to EPTA	kg	2,1
<b>Part number</b>	<b>7 228 05 51 00 0</b>	
<b>EAN</b>	<b>4014586867267</b>	
<b>Price in € [PC01]</b>	<b>604,80</b>	

**FEIN benefits:**

- ▶ FEIN high-power motor for highly effective material removal and constant speed even at high loads.
- ▶ Extremely easy to handle - tool-free, grinding arm can be swivelled 180°, tool-free belt installation and adjustment.
- ▶ Start set with stepped and straight grinding arms for a variety of applications, ceramic grinding belts for effective machining of welded seams and fleece belts for finishing work in various widths.
- ▶ Optimum belt speeds.
- ▶ Perfect belt guidance.
- ▶ Belt widths of between 3 and 20 mm.
- ▶ Infinitely variable speed, ideal for protecting sensitive surfaces.
- ▶ Soft start.
- ▶ Restart protection.
- ▶ H 07 industrial cable.
- ▶ Comprehensive range of accessories available.

**Price includes:**

1 belt file BF 10-280 E in plastic tool case, 3 grinding arms (1 each of 3/6 mm stepped, 6 mm straight, 20 mm straight), 10 grinding belts, 3 mm (grit 120), 10 grinding belts, 6 mm (grit 120), 10 grinding belts, 20 mm (grit 120), 5 fleece belts, 6 mm (medium)

**Accessories for WSG 17-70 Inox, ROT 14-200 E, MSf 636-1**



**Tool case**  
Plastic, inner dimensions: 470 x 275 x 116 mm

Part number	Price in €
3 39 01 118 01 0	37,26



**Plastic box**  
Box insert with lockable lid for small parts and accessories, suitable for tool box 3 39 01 118 01 0, max 5 items/box.

Part number	Price in €
3 39 01 119 00 0	3,97

**Accessories for RS 12-70 E**



**Basic pipe sander set**  
Cleaning off dirt, removing scratches and achieving a perfect satin finish. Consisting of: 2 x 10 grinding belts, 20 x 815 mm, P 120/P180; 2 x 10 grinding belts, 40 x 815 mm, P120/P180; 5 fleece belts, 20 x 820 mm, very fine 280

Part number	Price in €
6 37 14 050 02 1	196,74



**Pipe sander polishing set**  
From preparing to polish to achieving a perfect mirror polish. Consisting of: 2 x 10 grinding belts, 20 x 815 mm, P320/P400; 1 x 3 polishing belts, 20 x 815 mm; 1 tube pre-polishing cream, red (200ml); 1 tube colouring paste, white (200ml)

Part number	Price in €
6 37 14 052 02 3	161,61



**Ceramic sanding belts**  
Maximum material removal and very long service life. Also suitable for removing fine welded seams

Dimensions mm	No. in pack pcs	Part number	Price in €
20 x 815	10	6 37 14 130 01 0	42,70
40 x 815	10	6 37 14 131 01 0	67,08



**Grinding belts**  
Highly flexible sanding belts, ideal for sanding pipe bends  
20 x 815 mm

Grain	No. in pack pcs	Part number	Price in €
120	10	6 37 14 050 01 5	29,63
180	10	6 37 14 051 01 4	29,63
320	10	6 37 14 052 01 7	29,63
400	10	6 37 14 053 01 1	29,63



**Grinding belts**  
Highly flexible sanding belts, ideal for sanding pipe bends  
40 x 815 mm

Grain	No. in pack pcs	Part number	Price in €
120	10	6 37 14 054 01 9	48,65
180	10	6 37 14 055 01 3	48,65



**Fleece strips**  
Very soft version for smooth surfaces, even with tight pipe bends  
20 x 815 mm

Grain	No. in pack pcs	Part number	Price in €
80	5	6 37 14 056 01 6	34,22
120	5	6 37 14 057 01 0	34,22
280	5	6 37 14 058 01 8	40,11



**Polishing belts**  
20 x 815 mm, very soft version, for smooth mirror polish even with tight pipe bends

Part number	Price in €
6 37 26 010 01 8	57,98



**Rotating roller**  
For narrow spaces (distance from wall 50 mm)

Part number	Price in €
3 13 35 017 01 1	67,43

**Accessories for BF 10-280 E**



**Stepped grinding arm**

Belt width mm	Part number	Price in €
3/6	6 38 10 026 01 0	63,01



**Straight grinding arm**

Belt width mm	Part number	Price in €
6	6 38 10 027 01 0	63,01
20	6 38 10 030 01 0	82,39



**Ceramic grinding belt**  
Maximum material removal and very long service life. Also suitable for removing fine welded seams  
Pack of 10, 520 mm long.

Grain	Width mm	Part number	Price in €
80	3	6 37 14 061 01 0	13,23
120	3	6 37 14 062 01 0	13,23
180	3	6 37 14 063 01 0	13,23
80	6	6 37 14 068 01 0	14,67
120	6	6 37 14 069 01 0	14,67
180	6	6 37 14 070 01 0	14,67
80	20	6 37 14 089 01 0	20,20
120	20	6 37 14 090 01 0	20,20
180	20	6 37 14 091 01 0	20,20



**Fleece belt**  
Soft version for smooth surfaces.  
Pack of 5, 520 mm long.

Width mm	Model	Part number	Price in €
6	course	6 37 14 114 01 0	18,72
6	medium	6 37 14 115 01 0	18,72
6	fine	6 37 14 116 01 0	18,72
20	course	6 37 14 123 01 0	26,31
20	medium	6 37 14 124 01 0	26,31
20	fine	6 37 14 125 01 0	26,31



**Polishing belt**  
Soft version, for a smooth mirror polish in conjunction with FEIN polishing pastes.  
Pack of 3, 520 mm long.

Width mm	Part number	Price in €
6	6 37 26 016 01 0	12,00
20	6 37 26 019 01 0	16,53



**Accessories for WSG 17-70 Inox**



**Quick-clamping nut**  
to change discs without need for tool, low height of just 8 mm

Part number	Price in €
6 38 02 191 01 0	26,74



**Work gloves**  
Vibration-attenuating, certified according to EN 388/420, EN ISO 10819, EEC No. 0200, No. in pack 1 pair

Size	Part number	Price in €
9 L	3 21 73 003 00 3	72,18
10 XL	3 21 73 004 00 1	72,18
11 XXL	3 21 73 005 00 5	72,18



**Wheel guard**  
for serrated and roughing discs

Ø mm	Part number	Price in €
125	3 18 10 300 00 0	8,39



**Safety hood for cutting work**  
for safe working with cutting wheels

Ø mm	Part number	Price in €
125	6 38 11 017 01 0	27,86



**Inner flange**

Part number	Price in €
6 38 01 120 00 6	6,68



**Threaded flange**  
M 14, for flexible grinding/cutting discs, fan-pattern grinding wheels and round brush

Part number	Price in €
6 38 02 052 00 0	6,68



**Threaded flange**  
M 14, for elastic backing pad and for twisted steel wire brush

Part number	Price in €
6 38 01 154 00 7	6,68



**Elastic backing pad**  
with flange M 14, for fibre sanding sheets Ø 125 mm

Ø mm	Part number	Price in €
125	6 38 06 087 01 3	5,57



**Backing pad**  
M 14, Ø 125 mm, with Velcro attachment, for sanding sheets with Velcro rapid attachment

Ø mm	Part number	Price in €
115	6 38 06 168 01 2	10,33



**Backing pad**  
with Velcro attachment, for working with sanding fleece, M 14

Ø mm	Part number	Price in €
115	6 38 06 172 01 0	13,98



**Fleece sanding discs**  
Ø 115 mm, with Velcro attachment, for use with support plate 6 38 06 172 01 0

Model	No. in pack		Part number	Price in €
	pcs			
course	10		6 37 32 001 01 8	34,23
medium	10		6 37 32 002 01 1	32,49
fine	10		6 37 32 003 01 5	27,85



**Cool sanding pad**  
Rear-ventilated backing pad, ideal for Pyramix sanding discs

Ø mm	Part number	Price in €
115	6 38 06 193 01 0	11,12



**Cool sanding pad**  
Rear-ventilated backing pad, ideal for Pyramix sanding discs for use when the outer edge of the sanding discs has been removed.

Ø mm	Part number	Price in €
75	6 38 06 196 01 0	10,94



**Pyramix sanding sheet**  
The Pyramix hook and loop sanding disc features a new perforation pattern which means it can now also be used after the first edge has been worn away. Ø 115 mm. For removing deep scratches

Grain	No. in pack		Part number	Price in €
	pcs			
280	5		6 37 17 239 01 0	23,12
280	25		6 37 17 239 02 0	101,78



**Pyramix sanding sheet**  
The Pyramix hook and loop sanding disc features a new perforation pattern which means it can now also be used after the first edge has been worn away. Ø 115 mm. For removing minor scratches, creating sanding pattern, reducing roughness depth

Grain	No. in pack		Part number	Price in €
	pcs			
400	5		6 37 17 240 01 0	23,12
400	25		6 37 17 240 02 0	101,78



**Pyramix sanding sheet**  
The Pyramix hook and loop sanding disc features a new perforation pattern which means it can now also be used after the first edge has been worn away. Ø 115 mm. For removing very minor scratches, creating sanding pattern, reducing roughness depth

Grain	No. in pack		Part number	Price in €
	pcs			
800	5		6 37 17 241 01 0	23,12
800	25		6 37 17 241 02 0	101,78





**Pyramix sanding sheet**

The Pyramix hook and loop sanding disc features a new perforation pattern which means it can now also be used after the first edge has been worn away. Ø 115 mm. Reducing roughness depth, optimum preconditions for subsequent polishing

Grain	No. in pack pcs	Part number	Price in €
1 400	5	6 37 17 242 01 0	23,12
1 400	25	6 37 17 242 02 0	101,78



**Flap wheel**

diameter 125 mm, M 14

Grain	Part number	Price in €
120	6 37 21 052 01 0	24,23



**Finishing disc**

Ø 125 mm, for final finish

Part number	Price in €
6 37 32 005 01 0	24,49



**Abras.flap disc med.**

Ø 125 mm, for removing fine welded seams without damaging adjacent surfaces

No. in pack pcs	Part number	Price in €
10	6 37 30 018 01 0	171,00



**Stainless steel set for grinding pipes / profiles**

Sand fine welded seams without damaging adjacent surfaces. With subsequent surface finish. Consisting of: 10 x medium serrated grinding discs (6 37 30 018 01 0), 1 flap wheel, grit 120 (6 37 21 052 01 0), 1 finishing disc (6 37 32 005 01 0).

Part number	Price in €
6 37 21 052 02 0	216,14



**Stainless steel set – Preparing to polish surfaces / pipes / profiles**

Quickly and effectively removes scratches; optimum preparation for polishing with matched sanding pattern; when preparing for polishing: effective material removal in little time. Consisting of: 5 Pyramix sanding sheets, grit 280 (6 37 17 239 01 0), 5 Pyramix sanding sheets, grit 400 (6 37 17 240 01 0), 5 sanding sheets, grit 800 (6 37 17 241 01 0), 5 Pyramix sanding sheets, grit 1 400 (6 37 17 242 01 0), 1 cooling backing pad, Ø 75 mm (6 38 06 196 01 0), 25 sanding sheets, grit 80 (6 37 28 135 01 0), 1 cooling backing pad, Ø 115 mm (6 38 06 193 01 0)

Part number	Price in €
6 38 06 193 04 0	132,08

**Accessories for KS 10-38 E**



**Fleece disc**

With a high sanding capacity for sanding, descaling and satin-finishing fillet welds.

Ø mm	Thickness mm	Model	Part number	Price in €
150	3	course	6 37 34 001 01 0	27,66
150	6	course	6 37 34 002 01 0	34,71



**Fleece disc**

For sanding, levelling, descaling and fine satin-finishing of fillet welds. Removes scratches on profiles and surfaces with ease.

Ø mm	Thickness mm	Model	Part number	Price in €
150	3	medium	6 37 34 003 01 0	20,59
150	6	hard	6 37 34 004 01 0	25,28



**Fleece disc**

Removes tarnishing and minor scratches, ideal for preparing to polish fillet welds.

Ø mm	Thickness mm	Model	Part number	Price in €
150	3	fine	6 37 34 005 01 0	20,59
150	6	fine	6 37 34 006 01 0	25,28



**Fleece disc**

For pre-polishing surfaces of fillet welds. Quickly removes tarnishing without wearing away the welded seam.

Ø mm	Thickness mm	Model	Part number	Price in €
150	6	very fine	6 37 34 007 01 0	22,35



**Felt disc**

For polishing fillet welds to a mirror polish in conjunction with FEIN polishing paste.

Ø mm	Thickness mm	Part number	Price in €
150	6	6 37 18 011 01 0	14,48



**Profiling stone**

For sanding the fleece discs for even fillet weld profiles.

Part number	Price in €
6 37 19 011 01 0	18,24

**Accessory RS 10-70 E**



**Grinding belts**

Highly flexible sanding belts, ideal for sanding pipe bends. No. in pack 10, 30 x 533 mm.

Grain	Part number	Price in €
80	6 37 14 136 01 0	23,63
120	6 37 14 137 01 0	23,63
180	6 37 14 138 01 0	23,63
320	6 37 14 139 01 0	23,63
400	6 37 14 140 01 0	23,63



**Fleece strips**

Very soft version for smooth surfaces, even with tight pipe bends. No. in pack 5, 30 x 533 mm.

Model	Part number	Price in €
course	6 37 14 141 01 0	32,35
medium	6 37 14 142 01 0	32,35
fine	6 37 14 143 01 0	32,35





**Polishing belts**

Very soft version for smooth mirror polish, even with tight pipe bends.  
No. in pack 3, 30 x 533 mm.

Part number	Price in €
6 37 14 144 01 0	18,78

**Accessories for ROT 14-200 E**



**Protect.suction hood**

Part number	Price in €
3 18 10 264 01 0	18,64

**Protect.suction hood**

Part number	Price in €
3 18 10 240 01 4	20,87



**Connecting piece**

Universal device to connect power tools and accessories with dust extraction to vacuum cleaner. Flexible rubber sleeve, length 70 mm, inner diameter 31.5 mm.

Part number	Price in €
3 13 22 771 00 9	4,91



**Sanding sheets**

perforated, Ø 150 mm, with Velcro rapid attachment  
Application: Wood, metal, car bodies, welds. Quality: fully synthetic-resin bonded, corundum. Features: high sanding capacity.

Grain	No. in pack pcs	Part number	Price in €
60	50	6 37 28 022 01 7	51,46



**Sanding pad**

Ø 150 mm, with holes, with hook and loop fastener

Model	Part number	Price in €
hard	6 38 06 116 02 1	97,01
extra soft	6 38 06 166 02 6	95,55



**Sanding pad**

Ø 200 mm, with holes, with hook and loop fastener

Model	Part number	Price in €
hard	6 38 06 102 02 3	106,63
medium	6 38 06 095 02 1	107,33
extra soft	6 38 06 118 02 3	107,33



**Lambskin**

with Velcro rapid attachment.

Ø mm	Part number	Price in €
200	6 37 23 010 00 6	16,50

**Accessories for MSf 636-1**

**Hook and loop fastener**

Ø 150 mm

Ø mm	Part number	Price in €
150	3 14 26 030 00 5	15,77

**Sanding pad**

Ø 115 mm, without holes, with hook and loop fastener, hard

Part number	Price in €
6 38 06 167 02 0	35,21

**Eccentric head**

Ø 115 mm

Part number	Price in €
3 12 07 131 02 9	149,79



**Sanding sheets**

Ø 115 mm, for removing very deep scratches and fine welded seams

Grain	No. in pack pcs	Part number	Price in €
80	50	6 37 28 096 01 9	25,00



**Sanding pad**

Ø 125 mm, perforated, with hook and loop fastening

Model	Part number	Price in €
hard	6 38 06 103 02 7	72,38
medium	6 38 06 088 02 7	73,41
soft	6 38 06 117 02 5	93,65

**Sanding sheets**

perforated, Ø 125 mm, with Velcro rapid attachment  
Application: wood, paints, filler, automotive paints, fibreglass, plastics. Quality: fully synthetic-resin bonded, medium bond, corundum. Feature: greatly reduces glazing, high sanding capacity, flexible.

Grain	No. in pack pcs	Part number	Price in €
80	50	6 37 28 001 01 6	33,82
100	50	6 37 28 002 01 9	33,82



**Sanding pad**

Ø 150 mm, with holes, with hook and loop fastener

Model	Part number	Price in €
hard	6 38 06 101 02 0	84,48
medium	6 38 06 090 02 3	86,15
soft	6 38 06 114 02 4	80,73



**Eccentric head**

Ø 150 mm

Part number	Price in €
3 12 07 103 01 3	107,01



**Sanding sheets**

perforated, Ø 150 mm, with Velcro rapid attachment  
Application: Metal, car bodies, soldered points, welds, fibreglass.  
Quality: high-performance emery canvas, fully synthetic-resin bonded, corundum. Features: highly stable, high sanding capacity.

Grain	No. in pack pcs	Part number	Price in €
40	50	6 37 28 009 01 4	95,30
60	50	6 37 28 010 01 6	89,09
80	50	6 37 28 056 01 3	80,97
100	50	6 37 28 054 01 6	80,97



**Sanding sheets**

perforated, Ø 150 mm, with Velcro rapid attachment  
Application: wood, paint, automotive paints, filler, fibreglass, plastics. Quality: fully synthetic-resin bonded, corundum. Feature: greatly reduces glazing, flexible.

Grain	No. in pack pcs	Part number	Price in €
80	50	6 37 28 074 01 4	44,79
120	50	6 37 28 084 01 3	38,60
150	50	6 37 28 012 01 8	38,60
180	50	6 37 28 013 01 2	38,60
220	50	6 37 28 014 01 0	38,60
240	50	6 37 28 015 01 4	38,60
320	50	6 37 28 017 01 1	38,60
400	50	6 37 28 061 01 0	38,60



**Sanding sheets**

perforated, Ø 150 mm, with Velcro rapid attachment  
Application: Wood, metal, car bodies, welds. Quality: fully synthetic-resin bonded, light bond, corundum. Features: high sanding capacity.

Grain	No. in pack pcs	Part number	Price in €
40	50	6 37 28 072 01 2	47,63
60	50	6 37 28 073 01 6	45,73



**Lambskin**

with Velcro rapid attachment.

Ø mm	Part number	Price in €
125	6 37 23 008 00 0	7,53

**Accessories for KS 10-38 E, BF 10-280 E, RS 10-70 E, RS 12-70 E, WPO 14-25 E**



**Microfibre cloth**

Fine weave quality for cleaning polishing residue. Hem-free version means no scratches and no lint

Part number	Price in €
6 37 33 003 01 0	7,18

**Accessories for WPO 14-25 E**



**Standard stainless steel set for surfaces**

Set for standard applications in surface machining: cleaning off dirt with corrugated fleece, removing tarnishing and achieving a high-quality satin finish. Consisting of: 1 elastic sanding cylinder, grit 60 (6 37 21 006 01 2), 1 lamella fleece cylinder (6 37 21 009 01 8), 1 corrugated sanding fleece (6 37 23 021 01 3), 1 fine fleece sanding disc, pack of 10 (6 37 32 003 01 5), 1 support plate (6 38 06 172 01 0), 1 work arbour (6 38 03 066 02 4), 1 pin-type face spanner (6 29 10 022 00 2), 1 open-ended spanner 19 x 22 (6 29 04 003 00 0)

Part number	Price in €
6 37 21 006 04 0	191,16



**Stainless steel set for grinding surfaces**

Effective material removal for surfaces. Consisting of: 1 expansion cylinder (6 38 06 192 01 0), 5 sanding sleeves, grit 60 (6 37 14 132 01 0), 5 sanding sleeves, grit 80 (6 37 14 133 01 0), 5 sanding sleeves, grit 120 (6 37 14 134 01 0)

Part number	Price in €
6 38 06 192 02 0	192,55



**Stainless steel set for satin-finishing surfaces**

Perfect smooth satin finish. Very low build-up of heat during machining. Consisting of: 1 medium elastic sanding cylinder, grit 60 (6 37 21 006 01 2), 1 fine elastic sanding cylinder, grit 180 (6 37 21 007 01 6), 1 fine sine fleece sanding cylinder, grit 180 (6 37 21 051 01 0)

Part number	Price in €
6 37 21 050 02 0	204,96



**Standard stainless steel set for pipes**

Set for standard applications in the machining of straight pipes. Cleaning off dirt, removing tarnishing and achieving a high-quality satin finish. Consisting of: 1 grinding belt roller (6 38 06 181 01 6), 1 grinding belt, grit 60, pack of 10 (6 37 14 044 01 0), 1 grinding belt, grit 120, pack of 10 (6 37 14 045 01 4), 1 medium fleece belt (6 37 14 048 01 9), 1 fine fleece belt (6 37 14 049 01 3), 1 adhesive strip (6 38 09 004 01 9)

Part number	Price in €
6 38 06 181 03 0	135,80



**Stainless steel set – Satin-finishing profiles**

Satin-finishing of profiles for a perfect sanding pattern. Consisting of: 1 elastic cylinder, grit 60, medium (6 37 21 054 01 0), 1 elastic cylinder, grit 180, fine (6 37 21 055 01 0), 1 sine fleece sanding cylinder, fine (6 37 21 056 01 0), 1 work arbour (6 38 03 071 02 0)

Part number	Price in €
6 37 21 054 02 0	168,42



**Stainless steel set for polishing surfaces / pipes / profiles**

Polishing surfaces to a mirror polish. No lint build-up on the polishing rings. Consisting of: 1 sisal polishing ring (6 37 23 011 01 4), 2 rigid polishing ring cloths (6 37 23 013 01 1), 2 soft polishing ring cloths (6 37 23 014 01 9), 1 brush paste (6 37 26 027 01 0), 1 pre-polishing paste (6 37 26 028 01 0), 1 colouring paste (6 37 26 029 01 0), 1 work arbour (6 38 03 027 03 8), 1 pin-type face spanner (6 29 10 022 00 2), 1 open-ended spanner 19 x 22 (6 29 04 003 00 0)

Part number	Price in €
6 37 23 011 04 0	106,91



**Elastic sanding cylinder**

Bore 19 mm  
100 x 100 mm

Grain	Model	Part number	Price in €
60	medium	6 37 21 006 01 2	82,76
180	fine	6 37 21 007 01 6	82,76



**Elastic sanding cylinder**

Bore 19 mm  
100 x 50 mm

Grain	Model	Part number	Price in €
60	medium	6 37 21 054 01 0	57,54
180	fine	6 37 21 055 01 0	57,54



**Sine fleece sanding cylinder**

Bore 19 mm  
Ø 100 x 50 mm, with sine wave, for smooth satin finish

Grain	Model	Part number	Price in €
180	fine	6 37 21 056 01 0	33,33



**Sine fleece sanding cylinder**

Bore 19 mm  
Ø 100 x 100 mm, with sine wave, for smooth satin finish

Grain	Model	Part number	Price in €
180	fine	6 37 21 051 01 0	47,20



**Flap wheel**

diameter 150 mm, bore 14 mm  
For remedying minor mistakes and scratches

Part number	Price in €
6 37 21 003 01 7	53,32



**Flap wheel**

diameter 150 mm, bore 14 mm  
for medium brush applications

Part number	Price in €
6 37 21 004 01 5	53,32



**Flap wheel**

diameter 150 mm, bore 14 mm  
For for fine brush strokes, satin finish.

Part number	Price in €
6 37 21 005 01 9	53,32



**Lamella fleece cylinder**

diameter 100 x 100 mm, bore 19 mm  
For medium satin finish

Grain	Model	Part number	Price in €
100	medium	6 37 21 008 01 4	36,00



**Lamella fleece cylinder**

diameter 100 x 100 mm, bore 19 mm  
For fine satin finish

Grain	Model	Part number	Price in €
180	fine	6 37 21 009 01 8	36,00



**Lamella fleece cylinder**

diameter 100 x 100 mm, bore 19 mm  
For very fine satin finish

Grain	Model	Part number	Price in €
280	very fine	6 37 21 010 01 0	36,00



**Sanding fleece**

with corrugated folds, width approx. 30 mm, bore hole 14 mm,  
for light finishing work, derusting, polishing, and decorative  
work

Ø mm	Part number	Price in €
150	6 37 23 021 01 3	15,09
200	6 37 23 022 01 6	17,88



**Fleece sanding discs**

Ø 115 mm, with Velcro attachment, for use with support plate  
6 38 06 172 01 0

Model	No. in pack pcs	Part number	Price in €
course	10	6 37 32 001 01 8	34,23
medium	10	6 37 32 002 01 1	32,49
fine	10	6 37 32 003 01 5	27,85



**Backing pad**

with Velcro attachment, for working with sanding fleece, M 14

Ø mm	Part number	Price in €
115	6 38 06 172 01 0	13,98



**Sanding strip roll**

Bore 19 mm  
100 x 70 mm

Part number	Price in €
6 38 06 181 01 6	69,20



**Grinding belts**

600 x 30 mm

Grain	No. in pack pcs	Part number	Price in €
60	10	6 37 14 044 01 0	20,95
120	10	6 37 14 045 01 4	20,95
240	10	6 37 14 046 01 7	20,95

**Adhesive strip**

For re-fastening grinding belts in closed pipe systems, 50 m

Part number	Price in €
6 38 09 004 01 9	10,28



**Fleece strips**

With button closure for refastening, ideal for closed pipe  
systems, 600 x 30 mm

Model	Part number	Price in €
course	6 37 14 047 01 1	11,16
medium	6 37 14 048 01 9	11,16
fine	6 37 14 049 01 3	11,16



**Polishing rings, Sisal, cloth**

for

- fine finishing/brushing and levelling of non-ferrous metals following preliminary sanding with grain 240-280 using polishing paste "yellow".
- fine finishing/brushing and levelling of iron/steel, and stainless steel following preliminary sanding with grain 280-320 using polishing paste "yellow"
- matt-shining/brushing non-ferrous metals, iron/steel, and stainless steel using polishing paste "yellow".
- Preliminary polishing of iron/steel and stainless steel with preliminary polishing paste "orange" width about 30 mm, 14 mm bore

Ø mm	Part number	Price in €
150	6 37 23 011 01 4	16,80
200	6 37 23 012 01 7	23,46



**Polishing rings, hard cloth**

Width approx. 15 mm, bore hole 14 mm, for preliminary polishing and polishing of non-ferrous metals, iron/steel, stainless steel with preliminary polishing paste "orange"

Ø mm	Part number	Price in €
150	6 37 23 013 01 1	9,80
200	6 37 23 015 01 3	11,59



**Polishing rings, soft cloth**

Width approx. 15 mm, bore hole 14 mm, for high-gloss polishing of non-ferrous metals, iron/steel, stainless steel and chrome with final polishing paste "white"

Ø mm	Part number	Price in €
150	6 37 23 014 01 9	7,63
200	6 37 23 016 01 6	11,17

**Polishing rings, fleece, extra soft**

Width approx. 15 mm, bore hole 14 mm, for final polishing of non-ferrous metals, iron/steel, stainless steel and many plastics with final polishing paste "white"

Ø mm	Part number	Price in €
150	6 37 23 019 01 2	9,36
200	6 37 23 020 01 4	14,61



**Polishing wheel**

diameter 150 mm, width 60 mm, elastic, bore 14 mm for brush polishing, grain 16 (coarse), soft, "green"

Part number	Price in €
6 37 13 013 01 8	121,12



**Polishing wheel**

diameter 150 mm, width 60 mm, elastic, bore 14 mm for delicate surfaces, grit 24 (medium), soft, "blue"

Part number	Price in €
6 37 13 015 01 0	121,12

**Polishing wheel**

diameter 150 mm, width 60 mm, elastic, bore 14 mm for fine polishing, grit 46, soft, "brown"

Part number	Price in €
6 37 13 016 01 3	121,12



**Flap wheel**

Width 50 mm, for polishing rust-resistant steel, bore 14 mm

Ø mm	Part number	Price in €
200	6 37 21 001 00 1	124,43



**Brushing paste**

yellow, for Sisal/cloth for matt-shining of non-ferrous metals, iron/steel, and stainless steel

Part number	Price in €
6 37 26 027 01 0	7,35



**Preliminary polishing paste**

orange, for firm cloth, for matt-shining and polishing of non-ferrous metals, iron/steel, and stainless steel

Part number	Price in €
6 37 26 028 01 0	7,35



**Rumbling paste**

white, for soft cloth, for high-gloss polishing of non-ferrous metals, iron/steel, stainless steel, and chrome

Part number	Price in €
6 37 26 029 01 0	7,35



**Holder**

for side handle, 360° rotatable

Part number	Price in €
6 37 33 006 01 0	55,90



**Wheel arbor**

For satin-finishing tools (cylinders and rollers), tool holder Ø 19 mm

Length mm	Part number	Price in €
50	6 38 03 071 02 0	43,01
100	6 38 03 067 02 8	49,91



**Wheel arbor**

with clamping flange M 14, for polishing rings, clamping range 15-35 mm

Part number	Price in €
6 38 03 027 03 8	28,76



**Wheel arbor**

With wheel flange M 14, for lamella sanding discs, buffing and polishing discs, holding range 15 – 50 mm, tool mounting diameter 14 mm

Part number	Price in €
6 38 03 066 02 4	31,93



**Safety guard**

as hand guard

Part number	Price in €
3 02 29 216 00 5	5,20



**Expansion roller**

Bore 19 mm  
Ø 100 x 100 mm, for vibration-free, secure holding of sanding sleeves

Part number	Price in €
6 38 06 192 01 0	158,66



**Sanding sleeve**

For removing small welded seams and very deep scratches and mill scale

Grain	No. in pack pcs	Part number	Price in €
60	5	6 37 14 132 01 0	10,92



**Sanding sleeve**

For removing deep scratches

Grain	No. in pack pcs	Part number	Price in €
80	5	6 37 14 133 01 0	10,63



**Sanding sleeve**

For removing scratches, stage prior to satin-finishing

Grain	No. in pack pcs	Part number	Price in €
120	5	6 37 14 134 01 0	10,21

**Accessories for KS 10-38 E, WSG 17-70 Inox,  
ROT 14-200 E, WPO 14-25 E**



**anti-vibration handle**

M 8, vibration absorbing, to reduce the vibrations during longer jobs.

Part number	Price in €
3 21 19 124 01 0	8,48

**Accessories for ROT 14-200 E, MSf 636-1**



**Lambskin**

with Velcro rapid attachment.

Ø mm	Part number	Price in €
150	6 37 23 009 00 4	9,66



**Tool case**

Plastic, inner dimensions: 470 x 275 x 232 mm

Part number	Price in €
3 39 01 122 01 0	63,36

**Accessories for KS 10-38 E, BF 10-280 E, RS 10-70 E, RS 12-70 E**



**Pre-polishing cream, red**

for pre-polishing

Part number	Price in €
6 37 26 008 01 2	25,85



**Colouring paste, white**

for buffing and high-gloss polishing

Part number	Price in €
6 37 26 009 01 6	25,85



		WPO 14-15 E	WPO 14-15 E marine polishing set	WPO 14-15 E Set	WPO 14-15 E marine polishing set	WPO 14-25 E	WPO 10-25 E	WPO 10-25 E Set
		Extremely powerful angle polisher for vehicle and boat repairs.	Polishing set for boat repairs.	Extremely powerful angle polisher for vehicle and boat repairs.	Polishing set for boat repairs.	Extremely powerful angle polisher for refurbishing paintwork.	Powerful easy-to-use angle polisher for refurbishing paintwork.	
<b>Page</b>		203	203	203	204	204	204	205
<b>Application</b>	Rough sanding	▲	▲▲	▲	▲▲	▲▲		
	Fine sanding	▲	▲▲	▲	▲▲	▲▲		
	Micro-sanding	▲▲	▲▲	▲▲	▲▲	▲▲		
	Dry sanding	▲▲	▲▲	▲▲	▲▲	▲▲		
<b>Equipment</b>	polishing	▲▲	▲▲	▲▲	▲▲	▲▲	▲▲	▲▲
	FEIN high-power motor	●	●	●	●	●	●	●
	Suction		●					
	Spindle lock	●	●	●	●	●	●	●
	Restart protection	●	●	●	●	●	●	●
Soft start	●	●	●	●	●	●	●	
<b>Technical features</b>	Input	1 200 W	1 200 W	1 200 W	1 200 W	1 200 W	800 W	800 W
	Speed, no load	500 - 1 500 1/min	500 - 1 500 1/min	500 - 1 500 1/min	500 - 1 500 1/min	900 - 2 500 1/min	900 - 2 500 1/min	900 - 2 500 1/min
	Weight according to EPTA	2,5 kg	2,5 kg	2,5 kg	2,5 kg	2,5 kg	2,2 kg	2,2 kg
	Polishing disc Ø	230 mm	230 mm	230 mm	230 mm	230 mm	150 mm	150 mm
	Mounting thread	M 14	M 14	M 14	M 14	M 14	M 14	M 14

▲ suitability    ▲▲ optimal suitability    ● included

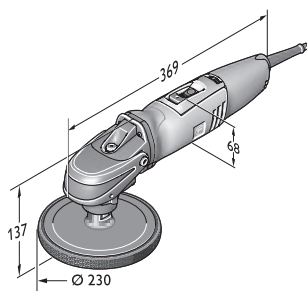

WPO 14-15 E

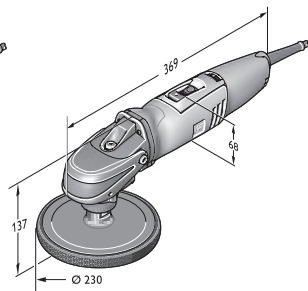

WPO 14-25 E

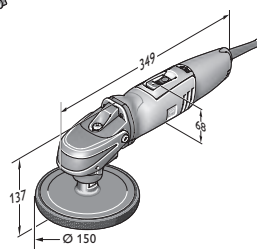

WPO 10-25 E



**WPO 14-15 E**

Extremely powerful angle polisher for vehicle and boat repairs.



For accessories, see page 205

Input	W	1 200
Output	W	750
Speed, no load	1/min	500 - 1 500
Polishing disc Ø	mm	230
Mounting thread		M 14
Cable with plug	m	4
Weight according to EPTA	kg	2,5
<b>Part number</b>		<b>7 221 48 00 23 0</b>
<b>EAN</b>		<b>4014586862699</b>
<b>Price in € [PC01]</b>		<b>418,95</b>

**FEIN benefits:**

- ▶ Ideal speed range with infinitely variable speed control for professional surface processing on vehicles and boats.
- ▶ Maximum speed stability at any load over the full setting range thanks to mechanical gear reduction in conjunction with the FEIN high-power motor.
- ▶ Special system accessories for the efficient refurbishment of used car paintwork, new car paintwork and highly scratch-resistant paints, and for cleaning, sanding and polishing boat surfaces and gelcoat layers.
- ▶ Convenient speed adjustment.
- ▶ Does not heat up in continuous use.
- ▶ Handle cover for excellent ergonomics.
- ▶ Spindle lock.
- ▶ Right or left-handed operation.
- ▶ Restart protection.
- ▶ Soft start.
- ▶ Carbon brushes with self cut-off function.
- ▶ Can be converted to rotary sander with extractor hood and backing pad.

**Price includes:**

1 Grip hood, 1 additional handle

**WPO 14-15 E marine polishing set**

Polishing set for boat repairs.



For accessories, see page 205

Input	W	1 200
Output	W	750
Speed, no load	1/min	500 - 1 500
Polishing disc Ø	mm	230
Mounting thread		M 14
Cable with plug	m	4
Weight according to EPTA	kg	2,5
<b>Part number</b>		<b>7 221 48 50 01 0</b>
<b>EAN</b>		<b>4014586862712</b>
<b>Price in € [PC01]</b>		<b>522,90</b>

**FEIN benefits:**

- ▶ Ideal speed range with infinitely variable speed control for professional surface machining on boats.
- ▶ Maximum speed stability at any load over the full setting range thanks to mechanical gear reduction in conjunction with the FEIN high-power motor.
- ▶ Special system accessories for the efficient refurbishment of used car paintwork, new car paintwork and highly scratch-resistant paints, and for cleaning, sanding and polishing boat surfaces and gelcoat layers.
- ▶ Convenient speed adjustment.
- ▶ Does not heat up in continuous use.
- ▶ Handle cover for excellent ergonomics.
- ▶ Spindle lock.
- ▶ Right or left-handed operation.
- ▶ Restart protection.
- ▶ Soft start.
- ▶ Carbon brushes with self cut-off function.
- ▶ Can be converted to rotary sander with extractor hood and backing pad.
- ▶ Wide range of accessories.
- ▶ Tool also available without accessories (7 221 48).

**Price includes:**

1 FEIN PowerPolisher WPO 14-15 E with handle cover and also with side anti-vibration handle in sturdy plastic case, 1 support plate with hook and loop fastening, Ø 170 mm, 1 polishing pad, Ø 195 mm, 1 lamb's wool, dome shape, Ø 235 mm, 1 Extractor hood, 1 sanding pad Ø 150 mm, 2 sanding fleeces for antifouling, 1 bristle fleece, 2 of each sanding sheet, Ø 150 mm, perforated, (G 80, 150, 180)

**WPO 14-15 E Set**

Extremely powerful angle polisher for vehicle and boat repairs.



For accessories, see page 205

Input	W	1 200
Output	W	750
Speed, no load	1/min	500 - 1 500
Polishing disc Ø	mm	230
Mounting thread		M 14
Cable with plug	m	4
Weight according to EPTA	kg	2,5
<b>Part number</b>		<b>7 221 48 51 01 0</b>
<b>EAN</b>		<b>4014586867069</b>
<b>Price in € [PC01]</b>		<b>430,50</b>

**FEIN benefits:**

- ▶ Ideal speed range with infinitely variable speed control for professional surface processing on vehicles and boats.
- ▶ Maximum speed stability at any load over the full setting range thanks to mechanical gear reduction in conjunction with the FEIN high-power motor.
- ▶ Special system accessories for the efficient refurbishment of used car paintwork, new car paintwork and highly scratch-resistant paints, and for cleaning, sanding and polishing boat surfaces and gelcoat layers.
- ▶ Convenient speed adjustment.
- ▶ Does not heat up in continuous use.
- ▶ Handle cover for excellent ergonomics.
- ▶ Spindle lock.
- ▶ Right or left-handed operation.
- ▶ Restart protection.
- ▶ Soft start.
- ▶ Carbon brushes with self cut-off function.
- ▶ Can be converted to rotary sander with extractor hood and backing pad.
- ▶ Tool also available without accessories (7 221 48).

**Price includes:**

1 anti-vibration handle, 1 Grip hood, 1 Support plate with Velcro attachment, Ø 150 mm, 1 Polishing sponge, Ø 150 mm, medium



**WPO 14-15 E marine polishing set** Polishing set for boat repairs.



For accessories, see page 205

Input	W	1 200
Output	W	750
Speed, no load	1/min	500 - 1 500
Polishing disc Ø	mm	230
Mounting thread		M 14
Cable with plug	m	4
Weight according to EPTA	kg	2,5
<b>Part number</b>		<b>7 221 48 60 00 0</b>
<b>EAN</b>		<b>4014586872216</b>
<b>Price in € [PC01]</b>		<b>399,00</b>

**FEIN benefits:**

- ▶ Ideal speed range with infinitely variable speed control for professional surface machining on boats.
- ▶ Maximum speed stability at any load over the full setting range thanks to mechanical gear reduction in conjunction with the FEIN high-power motor.
- ▶ Special system accessories for the efficient refurbishment of used car paintwork, new car paintwork and highly scratch-resistant paints, and for cleaning, sanding and polishing boat surfaces and gelcoat layers.
- ▶ Convenient speed adjustment.
- ▶ Does not heat up in continuous use.
- ▶ Handle cover for excellent ergonomics.
- ▶ Spindle lock.
- ▶ Right or left-handed operation.
- ▶ Restart protection.
- ▶ Soft start.
- ▶ Carbon brushes with self cut-off function.
- ▶ Can be converted to rotary sander with extractor hood and backing pad.
- ▶ Wide range of accessories.
- ▶ Tool also available without accessories (7 221 48).

**Price includes:**

1 FEIN PowerPolisher WPO 14-15 E with handle cover and also with side anti-vibration handle in sturdy plastic case, 1 support plate with hook and loop fastening, Ø 170 mm, 1 polishing pad, Ø 195 mm

**WPO 14-25 E**

Extremely powerful angle polisher for refurbishing paintwork.



For accessories, see page 205

Input	W	1 200
Output	W	750
Speed, no load	1/min	900 - 2 500
Polishing disc Ø	mm	230
Mounting thread		M 14
Cable with plug	m	4
Weight according to EPTA	kg	2,5
<b>Part number</b>		<b>7 221 49 51 01 0</b>
<b>EAN</b>		<b>4014586867113</b>
<b>Price in € [PC01]</b>		<b>430,50</b>

**FEIN benefits:**

- ▶ Ideal speed range with infinitely variable speed control for professional surface processing on vehicles and boats.
- ▶ Special system accessories for the efficient refurbishment of used car paintwork, new car paintwork and highly scratch-resistant paints, and for cleaning, sanding and polishing boat surfaces and gelcoat layers.
- ▶ Maximum speed stability at any load over the full setting range thanks to mechanical gear reduction in conjunction with the FEIN high-power motor.
- ▶ Excellent handling.
- ▶ Spindle lock.
- ▶ Right or left-handed operation.
- ▶ Restart protection.
- ▶ Soft start.
- ▶ H 07 industrial cable.
- ▶ Dustproof ball bearing.
- ▶ Carbon brushes with self cut-off function.
- ▶ Comprehensive range of accessories available.
- ▶ Tool also available without accessories (7 221 49).

**Price includes:**

1 anti-vibration handle, 1 Grip hood, 1 Support plate with Velcro attachment, Ø 150 mm, 1 Polishing sponge, Ø 150 mm, medium

**WPO 10-25 E**

Powerful easy-to-use angle polisher for refurbishing paintwork.



For accessories, see page 205

Input	W	800
Output	W	550
Speed, no load	1/min	900 - 2 500
Polishing disc Ø	mm	150
Mounting thread		M 14
Cable with plug	m	4
Weight according to EPTA	kg	2,2
<b>Part number</b>		<b>7 221 63 00 23 0</b>
<b>EAN</b>		<b>4014586866055</b>
<b>Price in € [PC01]</b>		<b>375,90</b>

**FEIN benefits:**

- ▶ Ideal speed range with infinitely variable speed control for professional surface machining on vehicles.
- ▶ Maximum speed stability at any load over the full setting range thanks to mechanical gear reduction in conjunction with the FEIN high-power motor.
- ▶ Special system accessories for effective refurbishing of new and used cars and highly scratch-resistant paintwork.
- ▶ Convenient speed adjustment.
- ▶ Does not heat up in continuous use.
- ▶ Handle cover for excellent ergonomics.
- ▶ Spindle lock.
- ▶ Right or left-handed operation.
- ▶ Restart protection.
- ▶ Soft start.
- ▶ Carbon brushes with self cut-off function.

**Price includes:**

1 additional handle, 1 Grip hood

**WPO 10-25 E Set**

Powerful easy-to-use angle polisher for refurbishing paintwork.



For accessories, see page 205

Input	W	800
Output	W	550
Speed, no load	1/min	900 - 2 500
Polishing disc Ø	mm	150
Mounting thread		M 14
Cable with plug	m	4
Weight according to EPTA	kg	2,2
<b>Part number</b>		<b>7 221 63 51 01 0</b>
<b>EAN</b>		<b>4014586867199</b>
<b>Price in € [PC01]</b>		<b>387,45</b>

**FEIN benefits:**

- ▶ Ideal speed range with infinitely variable speed control for professional surface machining on vehicles.
- ▶ Maximum speed stability at any load over the full setting range thanks to mechanical gear reduction in conjunction with the FEIN high-power motor.
- ▶ Special system accessories for effective refurbishing of new and used cars and highly scratch-resistant paintwork.
- ▶ Convenient speed adjustment.
- ▶ Does not heat up in continuous use.
- ▶ Handle cover for excellent ergonomics.
- ▶ Spindle lock.
- ▶ Right or left-handed operation.
- ▶ Restart protection.
- ▶ Soft start.
- ▶ Carbon brushes with self cut-off function.
- ▶ Tool also available without accessories (7 221 63).

**Price includes:**

1 anti-vibration handle, 1 Grip hood, 1 Support plate with Velcro attachment, Ø 150 mm, 1 Polishing sponge, Ø 150 mm, medium

**Polishers**

**General accessories**



**Tool case**

Plastic, inner dimensions: 470 x 275 x 232 mm

Part number	Price in €
3 39 01 122 01 0	63,36



**Microfibre cloth**

Fine weave quality for cleaning polishing residue. Hem-free version means no scratches and no lint

Part number	Price in €
6 37 33 003 01 0	7,18

**Accessories for WPO 10-25 E, WPO 14-15 E, WPO 14-15 XE, WPO 14-25 E**



**Paint refurbishing and finishing set**

Ideal range of accessories for refurbishing weathered and new paintwork. Also perfectly suited to finishing fresh paintwork (not suitable for matt paintwork). Plastic case contains: 1 FEIN single-stage polish, 1 kg; 1 FEIN top wax paint seal, 1 kg; 1 support plate, 150 mm; 1 lambskin, 150 mm; 2 medium-hard orange polishing sponges, 150 mm; 1 waffle pad; 53 mini sanding discs, grit 2 800; 1 manual sanding block; 1 moistening cube; 1 cleaning putty, 200 g; 2 microfibre cloths.

Part number	Price in €
6 37 23 028 04 0	203,56

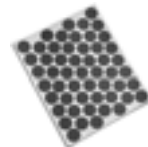

**Sanding disc**

Micro-fine self-adhesive sandpaper, 2 800 grain, for treating lacquer faults such as lacquer inclusions. 1 sheet of 53 sanding discs, Ø 30 mm. Fits on hand sanding block 6 37 33 002 01 0

Part number	Price in €
6 37 17 221 01 0	9,53



**Humidification sponge**

Easy-to-use foam cube for hygienic moisturizing the sanding discs.

Part number	Price in €
6 37 33 001 01 0	3,15



**Wax sealing**

Sprayable lacquer varnish for cleaning and permanently sealing polished surfaces. Removes polishing agent residues from plastic parts.

Contents ml	Part number	Price in €
500	6 37 26 025 01 0	17,92



**Sanding block**

Easy-to-use sanding block for holding self-adhesive sanding discs on both sides.

Part number	Price in €
6 37 33 002 01 0	11,75



**Cleaning putty**

FEIN cleaning putty gently removes deposits from paintwork and glass such as paint overspray, surface rust, tar, tree gums, insects, environmental deposits and brake dust from rims.

Part number	Price in €
6 37 33 007 01 0	32,47



**FEIN single-stage polish**

Ideal for slightly to severely damaged scratch-resistant paintwork. Excellent shine results in just one step. Silicone-free. Also ideal for gelcoat applications on yachts.

Contents kg	Part number	Price in €
1	6 37 26 014 01 0	41,76



**Backing pad**  
with Velcro attachment, M 14

Ø mm	Part number	Price in €
80	6 38 06 179 01 5	20,56
125	6 38 06 169 01 6	12,90
130	6 38 06 178 01 1	28,97
150	6 38 06 170 01 8	15,61



**Backing pad**  
for lamb's fleece with tensioning cord, rubber coated, M 14

Ø mm	Part number	Price in €
120	6 38 06 012 00 8	15,81



**Polishing sponge**  
For polishing painted surfaces. Various hardness grades: soft for new paintwork, medium for slightly weathered paintwork and applying wax, hard for severely weathered paintwork. Quick hook and loop fastening, height 40 mm.

Ø mm	Model	Part number	Price in €
100	soft	6 37 23 024 01 8	18,83
100	hard	6 37 23 023 01 0	18,83
125	medium	6 37 23 017 01 0	13,07
150	medium	6 37 23 018 01 8	14,41



**Polishing sponge orange 150 mm**  
Polishing sponge with fine pores, medium hard for new and old lacquers Ø 150 mm

Part number	Price in €
6 37 23 028 01 0	15,67



**Waffled sponge**  
Extremely fine and soft polishing sponge for removing holograms on dark lacquers. Ø 150 mm

Part number	Price in €
6 37 23 029 01 0	15,67



**Lambskin**  
with tensioning cord

Ø mm	Part number	Price in €
120	6 37 23 007 00 2	7,94



**Lambskin**  
with Velcro rapid attachment.

Ø mm	Part number	Price in €
125	6 37 23 008 00 0	7,53
150	6 37 23 009 00 4	9,66



**FEIN top wax paint seal**  
Long-lasting paint seals thanks to high-quality natural and synthetic waxes. For a sensational shine. Silicone-free.

Contents kg	Part number	Price in €
1	6 37 26 015 01 0	36,55

**Accessories for WPO 14-15 E**



**Backing pad**  
with Velcro attachment, M 14

Ø mm	Part number	Price in €
170	6 38 06 187 01 0	37,14



**Polishing sponge**  
Ø 195 mm for backing pads with a Ø of 170 mm, 6 38 06 187 01 0, M14 with hook and loop fastening system. Recommended working speed 500-1 000 rpm.

Ø mm	Part number	Price in €
195	6 37 23 034 01 0	17,38



**Bristle fleece**  
Bristle fleece for cleaning or polishing boat hulls and decks, with a Ø of 195 mm for backing pads with a Ø of 170 mm, 6 38 06 187 01 0, M14 with hook and loop fastening system. For fibreglass anti-slip structures. Recommended working speed: approx. 500 rpm.

Ø mm	Part number	Price in €
195	6 37 23 033 01 0	28,65



**Lamb's wool, dome shape**  
Diameter approx. 230 mm for backing pads with a Ø of 170 mm, 6 38 06 187 01 0, M 14 with hook and loop fastening system. Recommended working speed 500-1 200 rpm. Quality TOPWOOL, fleece polishing wheel. Lamb's wool/synthetic blend, washable.

Ø mm	Part number	Price in €
230	6 37 23 035 01 0	22,98



**Sanding pad**  
With hook and loop fastening, Ø 150 mm with M 14 suction hole. Hole circle suitable for FEIN and other sanding materials.

Ø mm	Part number	Price in €
150	6 38 06 188 01 0	61,98

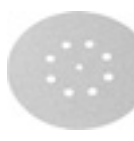

**Sanding sheets**  
perforated, Ø 150 mm, with Velcro rapid attachment  
Application: Metal, car bodies, soldered points, welds, fibreglass.  
Quality: high-performance emery canvas, fully synthetic-resin bonded, corundum. Features: highly stable, high sanding capacity.

Grain	No. in pack pcs	Part number	Price in €
60	50	6 37 28 010 01 6	89,09

**Sanding sheets**

perforated, Ø 150 mm, with Velcro rapid attachment

Application: wood, paint, automotive paints, filler, fibreglass, plastics. Quality: fully synthetic-resin bonded, corundum. Feature: greatly reduces glazing, flexible.

Grain	No. in pack pcs	Part number	Price in €
80	50	6 37 28 074 01 4	44,79
120	50	6 37 28 084 01 3	38,60
150	50	6 37 28 012 01 8	38,60
180	50	6 37 28 013 01 2	38,60
240	50	6 37 28 015 01 4	38,60
320	50	6 37 28 017 01 1	38,60

**Sanding fleece for antifoul**

Sanding fleece for light sanding and sanding down of coats of antifoul product. Produces a stunning sanding pattern without choking the sanding fleece. Very long service life.

Ø mm	No. in pack pcs	Part number	Price in €
150	5	6 37 32 004 01 0	19,87

**Protect.suction hood**

Part number	Price in €
3 18 10 264 01 0	18,64

**Connecting piece**

Universal device to connect power tools and accessories with dust extraction to vacuum cleaner. Flexible rubber sleeve, length 70 mm, inner diameter 31.5 mm.

Part number	Price in €
3 13 22 771 00 9	4,91

**Accessories for WPO 10-25 E, WPO 14-15 E****Tool case**

Plastic, inner dimensions: 470 x 275 x 116 mm

Part number	Price in €
3 39 01 118 01 0	37,26

**Accessories for WPO 14-15 E, WPO 14-25 E****Nylon barrel brush**

Ø 125 mm, grain 46, M 14, for brushing after removal by caustics, cleaning roof beams, restoration of antique furniture, roughing paint for new coats, deburring, and light derusting of metal parts

Part number	Price in €
6 37 22 048 01 4	37,15

**Accessories for WPO 14-15 E, WPO 14-15 XE****Backing pad**

with Velcro attachment, M 14

Ø mm	Part number	Price in €
200	6 38 06 171 01 7	24,61

**Backing pad**

for lamb's fleece with tensioning cord, rubber coated, M 14

Ø mm	Part number	Price in €
170	6 38 06 030 00 4	21,91

**Polishing sponge**

For polishing painted surfaces. Various hardness grades: soft for new paintwork, medium for slightly weathered paintwork and applying wax, hard for severely weathered paintwork. Quick hook and loop fastening, height 40 mm.

Ø mm	Model	Part number	Price in €
160	soft	6 37 23 026 01 5	23,96
160	hard	6 37 23 025 01 2	23,96

**Lambskin**

with tensioning cord

Ø mm	Part number	Price in €
170	6 37 23 003 00 3	14,52

**Lambskin**

with Velcro rapid attachment.

Ø mm	Part number	Price in €
200	6 37 23 010 00 6	16,50





## Over 40 years of experience: oscillating power tools from FEIN.

Backed by the unique experience acquired over more than 40 years of oscillation technology, FEIN offers three systems FEIN MULTIMASTER, FEIN SUPERCUT CONSTRUCTION and FEIN SUPERCUT AUTOMOTIVE - which make up an unbeatably versatile and powerful range of oscillating power tools. Each system is synonymous with professional application solutions and unrivalled load handling with a solution for every requirement. The FEIN SUPERCUT is the specialist for interior work with wood, repairing/replacing windows, tile restoration/ bathroom renovation, heating/sanitary installation, grout renewal, marine applications and vehicle glazing. As a universal system,

the FEIN MULTIMASTER is the right choice for everyone who strives for a versatile, professional tool. A wide range of accessories opens up a multitude of possible applications.



---

**FEIN MULTIMASTER / MULTITALENT** **Page 210**

The universal system for interior work and renovation.

**STARLOCK PLUS**



---

**FEIN SUPERCUT CONSTRUCTION** **Page 214**

The most powerful system for interior work and renovation.

**STARLOCK MAX**



---

**FEIN SUPERCUT CONSTRUCTION** **Page 231**

The most powerful system for interior work and renovation.



---

**FEIN SUPERCUT AUTOMOTIVE** **Page 239**

The most powerful system for vehicle repairs.



	FEIN MULTIMASTER FMM 350 QSL Top	FEIN MULTIMASTER FMM 350 QSL QuickStart	FEIN MULTIMASTER FMM 350 QSL Top Extra	FEIN MULTIMASTER FMM 350 QSL Marine	FEIN MULTITALENT FMT 250 QSL QuickStart	FEIN MULTITALENT FMT 250 SL Start	
	The powerful and universal system for interior work and renovation with the most extensive accessories for a fantastic range of applications.	The powerful and universal system for interior work and renovation with accessories for a wide range of applications.	The powerful and universal system for interior work and renovation with very wide range of accessories for outstanding versatility, including a versatile extractor.	The powerful and universal system with extensive accessories for interior, maintenance and repair work on yachts.	The universal system for interior work and renovation with QuickIN and the basic accessories needed for sanding and sawing.	The universal system for interior work and renovation with the basic accessories needed for sanding and sawing.	
<b>Page</b>	211	211	212	212	213	213	
<b>Technical features</b>	Input	350 W	350 W	350 W	350 W	250 W	250 W
	Oscillations	10 000 - 19 500 1/min	10 000 - 19 500 1/min	10 000 - 19 500 1/min	10 000 - 19 500 1/min	11 000 - 20 000 1/min	11 000 - 20 000 1/min
	Weight according to EPTA	1,4 kg	1,4 kg	1,4 kg	1,4 kg	1,4 kg	1,3 kg
	Sanding pad width	80 mm	80 mm	80 mm	80 mm	80 mm	80 mm
	Tool Holder	StarlockPlus	StarlockPlus	StarlockPlus	StarlockPlus	StarlockPlus	StarlockPlus
	Tool change	QuickIN	QuickIN	QuickIN	QuickIN	QuickIN	Manual with screw, hexagon socket
	Amplitude	2 x 1,7°	2 x 1,7°	2 x 1,7°	2 x 1,7°	2 x 1,6°	2 x 1,6°
	Mechanical interface	●	●	●	●		

● included

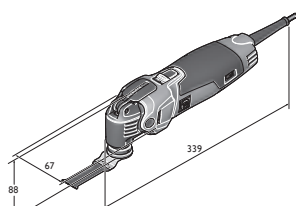

FMM 350 QSL

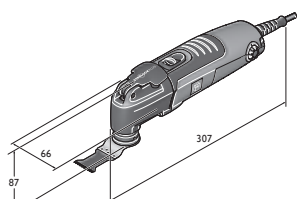

FMT 250 QSL  
FMT 250 SL





**FEIN MULTIMASTER FMM 350 QSL Top**

The powerful and universal system for interior work and renovation with the most extensive accessories for a fantastic range of applications.



For accessories, see page 218

For cordless variant of tool, see page 36

Input	W	350
Oscillations	1/min	10 000 - 19 500
Tool Holder		StarlockPlus
Tool change		QuickIN
Amplitude		2 x 1,7°
Sanding pad width	mm	80
Cable with plug	m	5
Weight according to EPTA	kg	1,4
<b>Part number</b>		<b>7 229 52 61 00 0</b>
<b>EAN</b>		<b>4014586884578</b>
<b>Price in € [PC03]</b>		<b>278,25</b>

**FEIN benefits:**

- ▶ FEIN anti-vibration system. Up to 70% fewer vibrations as the external motor housing is completely separate. For permanently safe working.
- ▶ Starlock standard tool mounting. 3D form ensures the perfect fit for accessories. 100% power transmission without losses for up to 35% more work progress.
- ▶ QuickIN tool change. Patented tool-free FEIN rapid clamping system for safe and easy tool changes in less than 3 seconds.
- ▶ StarlockPlus for outstanding versatility through access to the complete range of Starlock and StarlockPlus accessories.
- ▶ Very powerful 350 W FEIN high-power motor for maximum cutting speeds and work progress.
- ▶ Tacho generator. High-quality electronics for constant speeds under load. Infinitely variable electronic speed setting.
- ▶ Metal gearbox. Ability to withstand high loading and outstanding service life.
- ▶ Integrated interface for additional system accessories such as depth stop etc.
- ▶ Large working radius thanks to finely stranded 5 metre rubber cable of industrial quality.

**Price includes:**

1 FEIN MULTIMASTER FMM 350 QSL, 1 sanding pad, Sanding sheets, 3 each of grit 60, 80, 120, 180, 1 Sanding plate with holes, Perforated sanding sheets, 3 each of grit 60, 80, 120, 180, 1 backing pad Ø 115 mm, perforated, Perforated sanding sheets, 2 each of grit 60, 80, 180, 1 dust extraction device, 1 fixed scraper, 1 E-CUT long-life saw blade (35 mm), 1 Universal E-CUT saw blade (44 mm), 1 E-CUT long-life saw blade (65 mm), 1 HSS segment saw blade, 1 carbide segment saw blade, 1 carbide rasp (triangular), perforated, 1 plastic carrying case

**FEIN MULTIMASTER FMM 350 QSL QuickStart**

The powerful and universal system for interior work and renovation with accessories for a wide range of applications.



For accessories, see page 218

For cordless variant of tool, see page 36

Input	W	350
Oscillations	1/min	10 000 - 19 500
Tool Holder		StarlockPlus
Tool change		QuickIN
Amplitude		2 x 1,7°
Sanding pad width	mm	80
Cable with plug	m	5
Weight according to EPTA	kg	1,4
<b>Part number</b>		<b>7 229 52 62 00 0</b>
<b>EAN</b>		<b>4014586884691</b>
<b>Price in € [PC03]</b>		<b>231,00</b>

**FEIN benefits:**

- ▶ FEIN anti-vibration system. Up to 70% fewer vibrations as the external motor housing is completely separate. For permanently safe working.
- ▶ Starlock standard tool mounting. 3D form ensures the perfect fit for accessories. 100% power transmission without losses for up to 35% more work progress.
- ▶ QuickIN tool change. Patented tool-free FEIN rapid clamping system for safe and easy tool changes in less than 3 seconds.
- ▶ StarlockPlus for outstanding versatility through access to the complete range of Starlock and StarlockPlus accessories.
- ▶ Very powerful 350 W FEIN high-power motor for maximum cutting speeds and work progress.
- ▶ Tacho generator. High-quality electronics for constant speeds under load. Infinitely variable electronic speed setting.
- ▶ Metal gearbox. Ability to withstand high loading and outstanding service life.
- ▶ Integrated interface for additional system accessories such as depth stop etc.
- ▶ Large working radius thanks to finely stranded 5 metre rubber cable of industrial quality.

**Price includes:**

1 FEIN MULTIMASTER FMM 350 QSL, 1 sanding pad, Sanding sheets, 3 each of grit 60, 80, 120, 180, 1 fixed scraper, 1 Universal E-CUT saw blade (44 mm), 1 E-CUT long-life saw blade (65 mm), 1 HSS segment saw blade, 1 plastic carrying case

**FEIN MULTIMASTER FMM 350 QSL  
Top Extra**

The powerful and universal system for interior work and renovation with very wide range of accessories for outstanding versatility, including a versatile extractor.



For accessories, see page 218

For cordless variant of tool, see page 36

Input	W	350
Oscillations	1/min	10 000 - 19 500
Tool Holder		StarlockPlus
Tool change		QuickIN
Amplitude		2 x 1,7°
Sanding pad width	mm	80
Cable with plug	m	5
Weight according to EPTA	kg	1,4
<b>Part number</b>		<b>7 229 52 63 00 0</b>
<b>EAN</b>		<b>4014586884462</b>
<b>Price in € [PC03]</b>		<b>523,95</b>

**FEIN benefits:**

- ▶ FEIN anti-vibration system. Up to 70% fewer vibrations as the external motor housing is completely separate. For permanently safe working.
- ▶ Starlock standard tool mounting. 3D form ensures the perfect fit for accessories. 100% power transmission without losses for up to 35% more work progress.
- ▶ QuickIN tool change. Patented tool-free FEIN rapid clamping system for safe and easy tool changes in less than 3 seconds.
- ▶ StarlockPlus for outstanding versatility through access to the complete range of Starlock and StarlockPlus accessories.
- ▶ Very powerful 350 W FEIN high-power motor for maximum cutting speeds and work progress.
- ▶ Tacho generator. High-quality electronics for constant speeds under load. Infinitely variable electronic speed setting.
- ▶ Metal gearbox. Ability to withstand high loading and outstanding service life.
- ▶ Integrated interface for additional system accessories such as depth stop etc.
- ▶ Large working radius thanks to finely stranded 5 metre rubber cable of industrial quality.

**Price includes:**

1 FEIN MULTIMASTER FMM 350 QSL, 1 sanding pad, Sanding sheets, 3 each of grit 60, 80, 120, 180, 1 Sanding plate with holes, Perforated sanding sheets, 3 each of grit 60, 80, 120, 180, 1 backing pad Ø 115 mm, perforated, Perforated sanding sheets, 2 each of grit 60, 80, 180, 1 dust extraction device, 1 fixed scraper, 1 E-Cut long-life saw blade (35 mm), 1 Universal E-Cut saw blade (44 mm), 1 E-Cut long-life saw blade (65 mm), 1 HSS segment saw blade, 1 carbide segment saw blade, 1 carbide rasp (triangular), perforated, 1 plastic carrying case, 1 FEIN Dustex 25 L dust extractor

**FEIN MULTIMASTER FMM 350 QSL  
Marine**

The powerful and universal system with extensive accessories for interior, maintenance and repair work on yachts.



For accessories, see page 218

For cordless variant of tool, see page 36

Input	W	350
Oscillations	1/min	10 000 - 19 500
Tool Holder		StarlockPlus
Tool change		QuickIN
Amplitude		2 x 1,7°
Sanding pad width	mm	80
Cable with plug	m	5
Weight according to EPTA	kg	1,4
<b>Part number</b>		<b>7 229 52 66 00 0</b>
<b>EAN</b>		<b>4014586884851</b>
<b>Price in € [PC03]</b>		<b>304,50</b>

**FEIN benefits:**

- ▶ FEIN anti-vibration system. Up to 70% fewer vibrations as the external motor housing is completely separate. For permanently safe working.
- ▶ Starlock standard tool mounting. 3D form ensures the perfect fit for accessories. 100% power transmission without losses for up to 35% more work progress.
- ▶ QuickIN tool change. Patented tool-free FEIN rapid clamping system for safe and easy tool changes in less than 3 seconds.
- ▶ StarlockPlus for outstanding versatility through access to the complete range of Starlock and StarlockPlus accessories.
- ▶ Very powerful 350 W FEIN high-power motor for maximum cutting speeds and work progress.
- ▶ Tacho generator. High-quality electronics for constant speeds under load. Infinitely variable electronic speed setting.
- ▶ Metal gearbox. Ability to withstand high loading and outstanding service life.
- ▶ Integrated interface for additional system accessories such as depth stop etc.
- ▶ Large working radius thanks to finely stranded 5 metre rubber cable of industrial quality.

**Price includes:**

1 FEIN MULTIMASTER FMM 350 QSL, 1 sanding pad, Perforated sanding sheets, 3 each of grit 60, 80, 120, 180, 1 Sanding plate with holes, Sanding sheets, 3 each of grit 60, 80, 120, 180, 1 backing pad Ø 115 mm, perforated, Perforated sanding sheets, 2 each of grit 60, 80, 180, 1 fixed scraper, 2 felt polishing pads, triangular, 2 felt polishing pads 115 mm in diameter, 1 dust extraction device, 1 carbide segment saw blade, 1 carbide file, 1 E-Cut long-life saw blade (10 mm), 1 of each deck cutter blade (4+5 mm), 1 Universal E-Cut saw blade (44 mm), 1 E-Cut long-life saw blade (35 mm), 1 HSS saw blade (diameter 85 mm), 1 plastic carrying case



**FEIN MULTITALENT FMT 250 QSL QuickStart**



For accessories, see page 218  
For cordless variant of tool, see page 36

The universal system for interior work and renovation with QuickIN and the basic accessories needed for sanding and sawing.

Input	W	250
Oscillations	1/min	11 000 - 20 000
Tool Holder		StarlockPlus
Tool change		QuickIN
Amplitude		2 x 1,6°
Sanding pad width	mm	80
Cable with plug	m	5
Weight according to EPTA	kg	1,4
<b>Part number</b>		<b>7 229 53 61 00 0</b>
<b>EAN</b>		<b>4014586884905</b>
<b>Price in € [PC03]</b>		<b>179,55</b>

**FEIN benefits:**

- ▶ Starlock standard tool mounting. 3D form ensures the perfect fit for accessories. 100% power transmission without losses for up to 35% more work progress.
- ▶ QuickIN tool change. Patented tool-free FEIN rapid clamping system for safe and easy tool changes in less than 3 seconds.
- ▶ StarlockPlus for outstanding versatility through access to the complete range of Starlock and StarlockPlus accessories.
- ▶ Powerful 250 W FEIN high-power motor designed for continuous use.
- ▶ Electronic speed setting.
- ▶ Metal gearbox. Ability to withstand high loading and outstanding service life.
- ▶ Barrel-type design for maximum stability.
- ▶ Large working radius thanks to finely stranded 5 metre rubber cable of industrial quality.

**Price includes:**

1 FEIN MULTITALENT FMT 250 QSL, 1 sanding pad, Sanding sheets, 3 each of grit 80, 120, 180, 1 Universal E-CUT saw blade (44 mm), 1 plastic carrying case

**FEIN MULTITALENT FMT 250 SL Start**



For accessories, see page 218  
For cordless variant of tool, see page 36

The universal system for interior work and renovation with the basic accessories needed for sanding and sawing.

Input	W	250
Oscillations	1/min	11 000 - 20 000
Tool Holder		StarlockPlus
Tool change		Manual with screw, hexagon socket
Amplitude		2 x 1,6°
Sanding pad width	mm	80
Cable with plug	m	5
Weight according to EPTA	kg	1,3
<b>Part number</b>		<b>7 229 54 61 00 0</b>
<b>EAN</b>		<b>4014586885025</b>
<b>Price in € [PC03]</b>		<b>136,50</b>

**FEIN benefits:**

- ▶ Starlock standard tool mounting. 3D form ensures the perfect fit for accessories. 100% power transmission without losses for up to 35% more work progress.
- ▶ StarlockPlus for outstanding versatility through access to the complete range of Starlock and StarlockPlus accessories.
- ▶ Powerful 250 W FEIN high-power motor designed for continuous use.
- ▶ Electronic speed setting.
- ▶ Metal gearbox. Ability to withstand high loading and outstanding service life.
- ▶ Barrel-type design for maximum stability.
- ▶ Large working radius thanks to finely stranded 5 metre rubber cable of industrial quality.

**Price includes:**

1 plastic carrying case, Sanding sheets, 3 each of grit 80, 120, 180, 1 FEIN MULTITALENT FMT 250, 1 sanding pad, 1 Universal E-CUT saw blade (44 mm)



	FEIN SUPERCUT FSC 500 QSL	FEIN SUPERCUT FSC 500 QSL for interior work with wood	FEIN SUPERCUT FSC 500 QSL for repairing/re- placing windows	FEIN SUPERCUT FSC 500 QSL for tile restoration/ bathroom renova- tion	FEIN SUPERCUT FSC 500 QSL for heating/sani- tary installation	FEIN SUPERCUT FSC 500 QSL Composite	FEIN SUPERCUT FSC 500 QSL for grout renewal
	The powerful oscillator with quick clamping system for interior fitting and renovation.	The most powerful system for interior work and renovation with special accessories for fast and precise sawing work when fitting wood.	The most powerful system for interior work and renovation with special accessories for dismantling old windows and replacing putty-mounted insulating glass.	The most powerful system for interior work and renovation with special accessories for perfect removal of tiles and joints in bathroom renovation.	The most powerful system for interior work and renovation with special accessories for the key applications in sanitary repairs.	The most powerful system for interior work and renovation, for all key applications in the machining of CFRP and GRP parts.	The most powerful system for interior work and renovation with special accessories for grout renewal.
<b>Page</b>	215	215	215	216	216	217	217
<b>Technical features</b>	Input	450 W	450 W	450 W	450 W	450 W	450 W
	Output	250 W	250 W	250 W	250 W	250 W	250 W
	Oscillations	10 000 - 19 500 1/min	10 000 - 19 500 1/min	10 000 - 19 500 1/min	10 000 - 19 500 1/min	10 000 - 19 500 1/min	10 000 - 19 500 1/min
	Weight according to EPTA	1,6 kg	1,6 kg	1,6 kg	1,6 kg	1,6 kg	1,6 kg
	Cable with plug	5 m	5 m	5 m	5 m	5 m	5 m
	Tool Holder	StarlockMax	StarlockMax	StarlockMax	StarlockMax	StarlockMax	StarlockMax
	Tool change	QuickIN	QuickIN	QuickIN	QuickIN	QuickIN	QuickIN
	Mechanical interface	●	●	●	●	●	●

- included

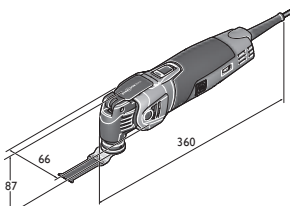

FSC 500 QSL



**FEIN SUPERCUT FSC 500 QSL**

The powerful oscillator with quick clamping system for interior fitting and renovation.



For accessories, see page 218  
For cordless variant of tool, see page 40

Input	W	450
Output	W	250
Oscillations	1/min	10 000 - 19 500
Tool Holder		StarlockMax
Tool change		QuickIN
Cable with plug	m	5
Weight according to EPTA	kg	1,6
<b>Part number</b>		<b>7 229 46 61 00 0</b>
<b>EAN</b>		<b>4014586885247</b>
<b>Price in € [PC03]</b>		<b>418,95</b>

- FEIN benefits:**
- ▶ FEIN anti-vibration system. Up to 70% fewer vibrations as the external motor housing is completely separate. For permanently safe working.
  - ▶ Starlock standard tool mounting. 3D form ensures the perfect fit for accessories. 100% power transmission without losses for up to 35% more work progress.
  - ▶ QuickIN tool change. Patented tool-free FEIN rapid clamping system for safe and easy tool changes in less than 3 seconds.
  - ▶ StarlockMax for unlimited versatility through access to the complete range of Starlock accessories.
  - ▶ 450 W FEIN high-power motor with high copper content for outstanding cutting speeds and maximum work progress, suited to continuous use and overload.
  - ▶ Tacho generator. High-quality electronics for constant speeds under load. Infinitely variable electronic speed setting.
  - ▶ Metal gearbox. Ability to withstand high loading and outstanding service life.
  - ▶ Integrated interface for additional system accessories such as depth stop etc.
  - ▶ Large working radius thanks to finely stranded 5 metre rubber cable of industrial quality.

**Price includes:**  
1 FEIN SUPERCUT FSC 500 QSL, 1 Systainer Sys 1

**FEIN SUPERCUT FSC 500 QSL for interior work with wood**

The most powerful system for interior work and renovation with special accessories for fast and precise sawing work when fitting wood.



For accessories, see page 218  
For cordless variant of tool, see page 40

Input	W	450
Output	W	250
Oscillations	1/min	10 000 - 19 500
Tool Holder		StarlockMax
Tool change		QuickIN
Cable with plug	m	5
Weight according to EPTA	kg	1,6
<b>Part number</b>		<b>7 229 46 62 00 0</b>
<b>EAN</b>		<b>4014586885308</b>
<b>Price in € [PC03]</b>		<b>523,95</b>

- FEIN benefits:**
- ▶ FEIN anti-vibration system. Up to 70% fewer vibrations as the external motor housing is completely separate. For permanently safe working.
  - ▶ Starlock standard tool mounting. 3D form ensures the perfect fit for accessories. 100% power transmission without losses for up to 35% more work progress.
  - ▶ QuickIN tool change. Patented tool-free FEIN rapid clamping system for safe and easy tool changes in less than 3 seconds.
  - ▶ StarlockMax for unlimited versatility through access to the complete range of Starlock accessories.
  - ▶ 450 W FEIN high-power motor with high copper content for outstanding cutting speeds and maximum work progress, suited to continuous use and overload.
  - ▶ Tacho generator. High-quality electronics for constant speeds under load. Infinitely variable electronic speed setting.
  - ▶ Metal gearbox. Ability to withstand high loading and outstanding service life.
  - ▶ Integrated interface for additional system accessories such as depth stop etc.
  - ▶ Large working radius thanks to finely stranded 5 metre rubber cable of industrial quality.

**Price includes:**  
1 FEIN SUPERCUT FSC 500 QSL, 1 HSS saw blade wood Ø 100 mm, 1 depth stop, 2 E-CUT precision BIM saw blades (form 205, 208), 5 E-CUT long-life saw blades (form 183, 160, 161, 201, 203), 2 E-CUT universal saw blades (form 151, 152), 1 sanding pad, 5 Sanding sheets each grit size (K 80, 120, 180), 1 Systainer Sys 1

**FEIN SUPERCUT FSC 500 QSL for repairing/replacing windows**

The most powerful system for interior work and renovation with special accessories for dismantling old windows and replacing putty-mounted insulating glass.



For accessories, see page 218  
For cordless variant of tool, see page 40

Input	W	450
Output	W	250
Oscillations	1/min	10 000 - 19 500
Tool Holder		StarlockMax
Tool change		QuickIN
Cable with plug	m	5
Weight according to EPTA	kg	1,6
<b>Part number</b>		<b>7 229 46 63 00 0</b>
<b>EAN</b>		<b>4014586885353</b>
<b>Price in € [PC03]</b>		<b>523,95</b>

- FEIN benefits:**
- ▶ FEIN anti-vibration system. Up to 70% fewer vibrations as the external motor housing is completely separate. For permanently safe working.
  - ▶ Starlock standard tool mounting. 3D form ensures the perfect fit for accessories. 100% power transmission without losses for up to 35% more work progress.
  - ▶ QuickIN tool change. Patented tool-free FEIN rapid clamping system for safe and easy tool changes in less than 3 seconds.
  - ▶ StarlockMax for unlimited versatility through access to the complete range of Starlock accessories.
  - ▶ 450 W FEIN high-power motor with high copper content for outstanding cutting speeds and maximum work progress, suited to continuous use and overload.
  - ▶ Tacho generator. High-quality electronics for constant speeds under load. Infinitely variable electronic speed setting.
  - ▶ Metal gearbox. Ability to withstand high loading and outstanding service life.
  - ▶ Integrated interface for additional system accessories such as depth stop etc.
  - ▶ Large working radius thanks to finely stranded 5 metre rubber cable of industrial quality.

**Price includes:**  
1 FEIN SUPERCUT FSC 500 QSL, 1 HSS saw blade wood Ø 100 mm, 1 HSS saw blade for metal (diameter 100 mm), 1 E-CUT long-life saw blade (form 203), 1 E-CUT universal saw blade (form 152), 1 Cutter blade, mushroom shaped, 1 segment saw blade (form 244), 1 depth stop, 1 sanding pad, 5 Sanding sheets each grit size (K 80, 120, 180), 1 Systainer Sys 1

Oscillating multi-tool

**FEIN SUPERCUT FSC 500 QSL**  
for tile restoration/bathroom renovation



For accessories, see page 218

For cordless variant of tool, see page 40

The most powerful system for interior work and renovation with special accessories for perfect removal of tiles and joints in bathroom renovation.

Input	W	450
Output	W	250
Oscillations	1/min	10 000 - 19 500
Tool Holder		StarlockMax
Tool change		QuickIN
Cable with plug	m	5
Weight according to EPTA	kg	1,6
<b>Part number</b>		<b>7 229 46 64 00 0</b>
<b>EAN</b>		<b>4014586885360</b>
<b>Price in € [PC03]</b>		<b>523,95</b>

**FEIN benefits:**

- ▶ FEIN anti-vibration system. Up to 70% fewer vibrations as the external motor housing is completely separate. For permanently safe working.
- ▶ Starlock standard tool mounting. 3D form ensures the perfect fit for accessories. 100% power transmission without losses for up to 35% more work progress.
- ▶ QuickIN tool change. Patented tool-free FEIN rapid clamping system for safe and easy tool changes in less than 3 seconds.
- ▶ StarlockMax for unlimited versatility through access to the complete range of Starlock accessories.
- ▶ 450 W FEIN high-power motor with high copper content for outstanding cutting speeds and maximum work progress, suited to continuous use and overload.
- ▶ Tacho generator. High-quality electronics for constant speeds under load. Infinitely variable electronic speed setting.
- ▶ Metal gearbox. Ability to withstand high loading and outstanding service life.
- ▶ Integrated interface for additional system accessories such as depth stop etc.
- ▶ Large working radius thanks to finely stranded 5 metre rubber cable of industrial quality.

**Price includes:**

1 FEIN SUPERCUT FSC 500 QSL, 1 segment blade, diamond-coated (form 243), 1 carbide saw blade, diameter 105 mm (form 214), 2 E-CUT universal saw blades (form 151, 152), 1 Cutter blade, mushroom shaped, 1 Stopper knife, 2 Rasps, carbide-coated, triangular, perforated for dust extractor, 1 Systainer Sys 1

**FEIN SUPERCUT FSC 500 QSL**  
for heating/sanitary installation



For accessories, see page 218

For cordless variant of tool, see page 40

The most powerful system for interior work and renovation with special accessories for the key applications in sanitary repairs.

Input	W	450
Output	W	250
Oscillations	1/min	10 000 - 19 500
Tool Holder		StarlockMax
Tool change		QuickIN
Cable with plug	m	5
Weight according to EPTA	kg	1,6
<b>Part number</b>		<b>7 229 46 65 00 0</b>
<b>EAN</b>		<b>4014586885407</b>
<b>Price in € [PC03]</b>		<b>523,95</b>

**FEIN benefits:**

- ▶ FEIN anti-vibration system. Up to 70% fewer vibrations as the external motor housing is completely separate. For permanently safe working.
- ▶ Starlock standard tool mounting. 3D form ensures the perfect fit for accessories. 100% power transmission without losses for up to 35% more work progress.
- ▶ QuickIN tool change. Patented tool-free FEIN rapid clamping system for safe and easy tool changes in less than 3 seconds.
- ▶ StarlockMax for unlimited versatility through access to the complete range of Starlock accessories.
- ▶ 450 W FEIN high-power motor with high copper content for outstanding cutting speeds and maximum work progress, suited to continuous use and overload.
- ▶ Tacho generator. High-quality electronics for constant speeds under load. Infinitely variable electronic speed setting.
- ▶ Metal gearbox. Ability to withstand high loading and outstanding service life.
- ▶ Integrated interface for additional system accessories such as depth stop etc.
- ▶ Large working radius thanks to finely stranded 5 metre rubber cable of industrial quality.

**Price includes:**

1 FEIN SUPERCUT FSC 500 QSL, 1 segment blade, diamond-coated (form 243), 1 of each cutting tool (12, 13 and 22 mm), 1 cutter blade, straight, long (form 239), 2 E-CUT universal saw blades (form 151, 152), 1 Stopper knife, 1 carbide-coated rasp, triangular, perforated for dust extraction, 1 Systainer Sys 1

**FEIN SUPERCUT FSC 500 QSL Composite**



For accessories, see page 218  
For cordless variant of tool, see page 40

The most powerful system for interior work and renovation, for all key applications in the machining of CFRP and GRP parts.

Input	W	450
Output	W	250
Oscillations	1/min	10 000 - 19 500
Tool Holder		StarlockMax
Tool change		QuickIN
Cable with plug	m	5
Weight according to EPTA	kg	1,6
<b>Part number</b>		<b>7 229 46 67 00 0</b>
<b>EAN</b>		<b>4014586885414</b>
<b>Price in € [PC03]</b>		<b>555,45</b>

**FEIN benefits:**

- ▶ FEIN anti-vibration system. Up to 70% fewer vibrations as the external motor housing is completely separate. For permanently safe working.
- ▶ Starlock standard tool mounting. 3D form ensures the perfect fit for accessories. 100% power transmission without losses for up to 35% more work progress.
- ▶ QuickIN tool change. Patented tool-free FEIN rapid clamping system for safe and easy tool changes in less than 3 seconds.
- ▶ StarlockMax for unlimited versatility through access to the complete range of Starlock accessories.
- ▶ 450 W FEIN high-power motor with high copper content for outstanding cutting speeds and maximum work progress, suited to continuous use and overload.
- ▶ Tacho generator. High-quality electronics for constant speeds under load. Infinitely variable electronic speed setting.
- ▶ Metal gearbox. Ability to withstand high loading and outstanding service life.
- ▶ Integrated interface for additional system accessories such as depth stop etc.
- ▶ Large working radius thanks to finely stranded 5 metre rubber cable of industrial quality.

**Price includes:**

1 FEIN SUPERCUT FSC 500 QSL, 1 E-Cut universal saw blade (form 152), 1 diamond saw blade, diameter 105 mm, 1 E-Cut carbide saw blade (form 191), 1 carbide file, 1 sanding pad, 5 Sanding sheets each grit size (K 80, 120, 180), 1 carbide-coated rasp, triangular, perforated for dust extraction, 1 dust extraction device, 1 plastic carrying case

**FEIN SUPERCUT FSC 500 QSL for grout renewal**



For accessories, see page 218  
For cordless variant of tool, see page 40

The most powerful system for interior work and renovation with special accessories for grout renewal.

Input	W	450
Output	W	250
Oscillations	1/min	10 000 - 19 500
Tool Holder		StarlockMax
Tool change		QuickIN
Cable with plug	m	5
Weight according to EPTA	kg	1,6
<b>Part number</b>		<b>7 229 46 70 00 0</b>
<b>EAN</b>		<b>4014586886176</b>
<b>Price in € [PC03]</b>		<b>586,95</b>

**FEIN benefits:**

- ▶ FEIN anti-vibration system. Up to 70% fewer vibrations as the external motor housing is completely separate. For permanently safe working.
- ▶ Starlock standard tool mounting. 3D form ensures the perfect fit for accessories. 100% power transmission without losses for up to 35% more work progress.
- ▶ QuickIN tool change. Patented tool-free FEIN rapid clamping system for safe and easy tool changes in less than 3 seconds.
- ▶ StarlockMax for unlimited versatility through access to the complete range of Starlock accessories.
- ▶ 450 W FEIN high-power motor with high copper content for outstanding cutting speeds and maximum work progress, suited to continuous use and overload.
- ▶ Tacho generator. High-quality electronics for constant speeds under load. Infinitely variable electronic speed setting.
- ▶ Metal gearbox. Ability to withstand high loading and outstanding service life.
- ▶ Integrated interface for additional system accessories such as depth stop etc.
- ▶ Large working radius thanks to finely stranded 5 metre rubber cable of industrial quality.

**Price includes:**

1 FEIN SUPERCUT FSC 500 QSL, 1 dust extraction device, 1 Vibration-attenuating bail handle, 1 cutter blade, straight, long (form 239), 5 Cutter blades, straight (form 236), 1 cleaning knife, diamond-coated, straight (form 237), 1 cleaning block, 1 plastic carrying case

Oscillating multi-tool







# Starlock: The new system standard for oscillating power tools.

Combined with the new FEIN tools, Starlock enables extremely reliable and fast accessory changes in a record time of less than 3 seconds. It also guarantees a secure fit and therefore optimum power transfer. The result: up to around 35% faster work progress depending on the accessory, noticeably improved precision and reduced noise. The new accessories are of course 100% compatible with all older FEIN oscillators on the market. To protect the individual tools from overload and damage, the system is divided into 3 performance classes: Starlock, StarlockPlus and StarlockMax. What has not changed: New products are continually being added to the range of FEIN genuine accessories, which

is the largest accessory range on the market. The performance potential of an oscillating tool can only be fully exploited with the right accessories. The exceptional quality and service life of FEIN genuine accessories combined with the perfect results delivers excellent value for money. FEIN genuine accessories are always the best choice.

The following table shows at a glance which accessory suits which product:

	<b>STARLOCK</b> 	<b>STARLOCK PLUS</b> 	<b>STARLOCK MAX</b> 	
	Universal Starlock fitting, suitable for all popular multi-function tools.	StarlockPlus fitting, suitable for all popular multi-function tools with StarlockPlus and StarlockMax fitting and for all FEIN MULTITALENT and MULTIMASTER tools up until 04/16.	StarlockMax fitting, can be used on all multi-function tools with suitable fitting. With adapter, suitable for all FEIN SUPERCUT before 04/16 too.	FEIN SUPERCUT 12-sided fitting, suitable for all FEIN SUPERCUT FSC 2.0 (Q), FSC 1.6 (Q), (A)FSC 1.7 (Q), AFSC 18.
<b>Starlock (SL)</b>	SL	SLP	SLM	
BOSCH GOP 12 V-28 PMF 220 CE, PMF 250 CES	✓	✗	✗	✗
<b>StarlockPlus (SLP)</b>				
FEIN MULTITALENT: AFMT 12 SL, AFMT 12 QSL FMT 250 SL, FMT 250 QSL				
FEIN MULTIMASTER: AFMM 18 QSL FMM 350 QSL	✓	✓	✗	✗
BOSCH: GOP 30-28, GOP 40-30, GOP 18 V-28 PMF 350 CES				
<b>StarlockMax (SLM)</b>				
FEIN SUPERCUT: AFSC 18 QSL, AFSC 18 QCSL FSC 500 QSL	✓	✓	✓	✗
BOSCH GOP 55-36				
<b>Compatibility with FEIN tools without Starlock mounting</b>				
FEIN MULTITALENT/ MULTIMASTER (- 03/2016)	✓	✓	✗	✗
FEIN SUPERCUT CONSTRUCTION (- 03/2016) FSC 2.0 Q, AFSC 18		✓		
FEIN SUPERCUT AUTOMOTIVE FSC 1.6 Q, FSC 1.7 Q, AFSC 1.7 Q, AFSC 1.7 QC		+ adapter 3 52 22 952 05 0		✓
FEIN SUPERCUT AUTOMOTIVE FSC 1.6, FSC 1.7		✓ + adapter 3 52 22 952 04 0		
<b>Miscellaneous multi-tools</b>				
Makita, Hitachi, Metabo, Milwaukee, AEG, Einhell, Ryobi, Skil, etc.	✓	✗	✗	✗

Starlock, the new standard tool mounting for multi-tools with patent pending, was jointly developed by FEIN and Bosch. Starlock, StarlockPlus and StarlockMax are registered trademarks of C. & E. Fein GmbH and Robert Bosch GmbH.



**Sawing**



**Saw blade**

For all soft materials. Segmented, ideal for working in corners and on edges without overcutting.

Ø mm	Mount	Part number	Price in €
85	SL	6 35 02 113 21 0	19,19



**HSS saw blade**

Solid HSS saw blade with metal teeth for sheet metal up to approx. 1 mm. Also for plastics, fibreglass-reinforced plastic, wood, putty and copper/copper alloys. Outstanding cutting speed. Clean, thin cutting line. Circular shape delivers good cost-effectiveness.

Ø mm	Mount	No. in pack pcs	Part number	Price in €
85	SL	1	6 35 02 097 21 0	19,66
85	SL	2	6 35 02 097 22 0	37,35
85	SL	5	6 35 02 097 23 0	88,45



**HSS saw blade**

Solid HSS saw blade with metal teeth for sheet metal up to approx. 1 mm. Also for plastics, fibreglass-reinforced plastic, wood, putty and copper/copper alloys. Outstanding cutting speed. Clean, thin cutting line. Segmented, ideal for working in corners and on edges without overcutting.

Ø mm	Mount	No. in pack pcs	Part number	Price in €
85	SL	1	6 35 02 106 21 0	22,54
85	SL	2	6 35 02 106 22 0	42,83
85	SL	5	6 35 02 106 23 0	101,45



**HSS saw blade**

Bimetal for long tool life. Metal teeth for sheet metal up to approx. 1 mm. Also for plastics, fibreglass-reinforced plastic, wood, putty and copper/copper alloys. Work flush with the surface. Circular shape delivers good cost-effectiveness.

Ø mm	Mount	No. in pack pcs	Part number	Price in €
85	SL	1	6 35 02 174 21 0	40,17
85	SL	5	6 35 02 174 23 0	180,78



**HSS saw blade**

Bimetal for long tool life. Metal teeth for sheet metal up to approx. 1 mm. Also for plastics, fibreglass-reinforced plastic, wood, putty and copper/copper alloys. Work flush with the surface. Circular shape and extra large diameter deliver optimum cost-effectiveness.

Ø mm	Mount	No. in pack pcs	Part number	Price in €
100	SLP	1	6 35 02 175 21 0	41,82
100	SLP	5	6 35 02 175 23 0	188,20



**HSS saw blade**

Bimetal for long tool life. Metal teeth for sheet metal up to approx. 1 mm. Also for plastics, fibreglass-reinforced plastic, wood, putty and copper/copper alloys. Work flush with the surface. Segmented, ideal for working in corners and on edges without overcutting.

Ø mm	Mount	No. in pack pcs	Part number	Price in €
100	SLP	1	6 35 02 196 21 0	41,82
100	SLP	5	6 35 02 196 23 0	188,20



**HSS saw blade**

Bimetal for long tool life. Set wood teeth. Outstanding tool life, high cutting quality and speed. As "mini circular saw", ideal for long, straight cuts and for making cut-outs in laid parquet, laminate and wall panelling.

Ø mm	Mount	No. in pack pcs	Part number	Price in €
100	SLP	1	6 35 02 176 21 0	49,82



**HSS saw blade set**

Bimetal for long tool life. Set wood teeth. Outstanding tool life, high cutting quality and speed. As "mini circular saw", ideal for long, straight cuts and for making cut-outs in laid parquet, laminate and wall panelling. The depth stop can also be used with many other FEIN accessories. For accurate working at depth. StarlockPlus fitting, suitable for all popular multi-function tools with StarlockPlus and StarlockMax fitting and for all FEIN MULTITALENT and MULTIMASTER tools up until 04/16. Scope of supply: 1 HSS saw blade, 1 depth stop (suitable for FMM 350 QSL, AFMM 18 QSL, AFSC 18 QSL, FSC 500 QSL)

Ø mm	Mount	Part number	Price in €
100	SLP	3 52 22 952 01 0	64,81



**Contact guard**

Spare contact guard for HSS saw blade 6 35 02 176 21 0.

Part number	Price in €
3 43 00 000 00 1	4,33



**Depth stop**

Depth stop for all saw blades. For accurate working at depth. Effective protection for blade and workpiece. Contents: 1 adapter for attachment to the machine, rotates freely through 360°. 1 depth stop, 1 depth-adjustable guide block. Can only be used with (A)FMM or (A)FSC.

Part number	Price in €
3 21 27 069 01 0	18,52



**Best of E-Cut accessory set**

Includes 6 different E-Cut saw blades with bimetallic teeth at a special price in a practical plastic storage box. Contents: E-Cut universal saw blades (1 x 28 mm and 1 x 44 mm wide) and E-Cut long-life saw blades (2 x 35 mm and 2 x 65 mm wide).

Mount	Part number	Price in €
SLP	3 52 22 942 05 0	61,95



**E-Cut-Combo**

Collection of the 3 most popular FEIN E-Cut saw blades for universal use. Better value than buying items separately. Perfectly equipped for all sawing applications. Supplied: 1 E-Cut long-life saw blade 35 mm wide, 1 E-Cut long-life saw blade 65 mm wide and 1 E-Cut universal saw blade 44 mm wide.

Mount	Part number	Price in €
SLP	3 52 22 952 03 0	41,90



**E-Cut long-life saw blade**

Bimetal with set wood teeth for all wood, plasterboard and plastic materials. Outstanding tool life, high cutting quality and speed. Extremely robust, not affected by nails (up to diameter of approx. 4 mm) in wood, masonry etc. Short, very narrow shape for the smallest of recesses.

Width mm	Length mm	Mount	No. in pack pcs	Part number	Price in €
10	30	SL	1	6 35 02 184 21 0	8,11
10	30	SL	3	6 35 02 184 22 0	23,10
10	30	SL	5	6 35 02 184 23 0	36,48
10	30	SL	10	6 35 02 184 24 0	68,90
10	30	SL	50	6 35 02 184 25 0	303,98
20	34	SL	1	6 35 02 183 21 0	10,50
20	34	SL	3	6 35 02 183 22 0	29,93
20	34	SL	5	6 35 02 183 23 0	47,25
20	34	SL	10	6 35 02 183 24 0	89,25
20	34	SL	50	6 35 02 183 25 0	393,75

Oscillating multi-tool



**E-Cut long-life saw blade**

Bimetal with set wood teeth for all wood, plasterboard and plastic materials. Outstanding tool life, high cutting quality and speed. Extremely robust, not affected by nails (up to diameter of approx. 4 mm) in wood, masonry etc. Medium width, with waist for optimum cutting speed and good swarf removal.

Width mm	Length mm	Mount	No. in pack pcs	Part number	Price in €
35	50	SL	1	6 35 02 160 21 0	13,76
35	50	SL	3	6 35 02 160 22 0	39,21
35	50	SL	5	6 35 02 160 23 0	61,90
35	50	SL	10	6 35 02 160 24 0	116,92
35	50	SL	50	6 35 02 160 25 0	515,81



**E-Cut long-life saw blade**

Bimetal with set wood teeth for all wood, plasterboard and plastic materials. Outstanding tool life, high cutting quality and speed. Extremely robust, not affected by nails (up to diameter of approx. 4 mm) in wood, masonry etc. Wide shape for maximum cutting performance and long, straight cuts.

Width mm	Length mm	Mount	No. in pack pcs	Part number	Price in €
50	50	SL	1	6 35 02 221 21 0	14,92
50	50	SL	3	6 35 02 221 22 0	42,53
50	50	SL	5	6 35 02 221 23 0	67,15
50	50	SL	10	6 35 02 221 24 0	126,83
50	50	SL	50	6 35 02 221 25 0	559,52
65	50	SL	1	6 35 02 228 21 0	13,97
65	50	SL	3	6 35 02 228 22 0	39,81
65	50	SL	5	6 35 02 228 23 0	62,84
65	50	SL	10	6 35 02 228 24 0	118,70
65	50	SL	50	6 35 02 228 25 0	523,69



**E-Cut long-life saw blade**

Bimetal with set wood teeth for all wood, plasterboard and plastic materials. Outstanding tool life, high cutting quality and speed. Extremely robust, not affected by nails (up to diameter of approx. 4 mm) in wood, masonry etc. Extra wide shape for maximum cutting performance and long, straight cuts.

Width mm	Length mm	Mount	No. in pack pcs	Part number	Price in €
65	50	SLP	1	6 35 02 161 21 0	15,21
65	50	SLP	3	6 35 02 161 22 0	43,38
65	50	SLP	5	6 35 02 161 23 0	68,49
65	50	SLP	10	6 35 02 161 24 0	129,37
65	50	SLP	50	6 35 02 161 25 0	570,72



**E-Cut standard saw blade**

Set teeth for all wood, plasterboard and plastic materials, high cutting quality and speed. Medium width, with waist for optimum cutting speed and good swarf removal.

Width mm	Length mm	Mount	No. in pack pcs	Part number	Price in €
35	50	SL	1	6 35 02 133 21 0	11,94
35	50	SL	3	6 35 02 133 22 0	34,02
35	50	SL	5	6 35 02 133 23 0	53,73
35	34	SL	10	6 35 02 133 24 0	101,48
35	50	SL	50	6 35 02 133 25 0	447,70



**E-Cut standard saw blade**

Set teeth for all wood, plasterboard and plastic materials, high cutting quality and speed. Wide shape for maximum cutting performance and long, straight cuts.

Width mm	Length mm	Mount	No. in pack pcs	Part number	Price in €
65	50	SLP	1	6 35 02 134 21 0	13,16
65	50	SLP	3	6 35 02 134 22 0	37,49
65	50	SLP	5	6 35 02 134 23 0	59,19
65	50	SLP	10	6 35 02 134 24 0	111,79
65	50	SLP	50	6 35 02 134 25 0	493,20



**E-Cut standard saw blade curved**

Set teeth for all wood, plasterboard and plastic materials, high cutting quality and speed. Curved cutting geometry for optimum plunging and clean precise cut edges, especially on smooth surfaces. Narrow, with waist for optimum cutting speed and good swarf removal.

Width mm	Length mm	Mount	No. in pack pcs	Part number	Price in €
35	55	SL	1	6 35 02 227 21 0	12,18
35	55	SL	3	6 35 02 227 22 0	34,71
35	55	SL	5	6 35 02 227 23 0	54,81
35	55	SL	10	6 35 02 227 24 0	103,53
35	55	SL	50	6 35 02 227 25 0	456,75



**E-Cut standard saw blade curved**

Set teeth for all wood, plasterboard and plastic materials, high cutting quality and speed. Curved cutting geometry for optimum plunging and clean precise cut edges, especially on smooth surfaces. Medium width for various uses.

Width mm	Length mm	Mount	No. in pack pcs	Part number	Price in €
50	50	SL	1	6 35 02 226 21 0	12,72
50	50	SL	3	6 35 02 226 22 0	36,24
50	50	SL	5	6 35 02 226 23 0	57,23
50	50	SL	10	6 35 02 226 24 0	108,09
50	50	SL	50	6 35 02 226 25 0	476,84



**E-Cut standard saw blade curved**

Set teeth for all wood, plasterboard and plastic materials, high cutting quality and speed. Curved cutting geometry for optimum plunging and clean precise cut edges, especially on smooth surfaces. Wide shape for maximum cutting performance and long, straight cuts.

Width mm	Length mm	Mount	No. in pack pcs	Part number	Price in €
65	50	SL	1	6 35 02 225 21 0	13,16
65	50	SL	3	6 35 02 225 22 0	37,50
65	50	SL	5	6 35 02 225 23 0	59,21
65	50	SL	10	6 35 02 225 24 0	111,84
65	50	SL	50	6 35 02 225 25 0	493,37



**E-Cut precision BIM saw blade**

Bimetal with double-row Japan teeth for all wooden materials, plasterboard and soft plastics. Improved tool life and robustness. The fastest cutting speed and maximum precision. Narrow, with waist for optimum cutting speed and good swarf removal.

Width mm	Length mm	Mount	No. in pack pcs	Part number	Price in €
35	50	SL	1	6 35 02 205 21 0	15,95
35	50	SL	3	6 35 02 205 22 0	45,45
35	50	SL	5	6 35 02 205 23 0	71,78
35	50	SL	10	6 35 02 205 24 0	135,58
35	50	SL	50	6 35 02 205 25 0	598,11



**E-Cut precision BIM saw blade**

Bimetal with double-row Japan teeth for all wooden materials, plasterboard and soft plastics. Improved tool life and robustness. The fastest cutting speed and maximum precision. Medium width for various uses.

Width mm	Length mm	Mount	No. in pack		Price in €
			pcs	Part number	
45	50	SLP	1	6 35 02 206 21 0	16,71
45	50	SLP	3	6 35 02 206 22 0	47,62
45	50	SLP	5	6 35 02 206 23 0	75,18
45	50	SLP	10	6 35 02 206 24 0	142,01
45	50	SLP	50	6 35 02 206 25 0	626,54



**E-Cut precision BIM saw blade**

Bimetal with double-row Japan teeth for all wooden materials, plasterboard and soft plastics. Improved tool life and robustness. The fastest cutting speed and maximum precision. Wide shape for effective sawing.

Width mm	Length mm	Mount	No. in pack		Price in €
			pcs	Part number	
55	50	SLP	1	6 35 02 207 21 0	17,15
55	50	SLP	3	6 35 02 207 22 0	48,87
55	50	SLP	5	6 35 02 207 23 0	77,16
55	50	SLP	10	6 35 02 207 24 0	145,75
55	50	SLP	50	6 35 02 207 25 0	643,01



**E-Cut precision BIM saw blade**

Bimetal with double-row Japan teeth for all wooden materials, plasterboard and soft plastics. Improved tool life and robustness. The fastest cutting speed and maximum precision. Extra wide shape for maximum cutting performance and long, straight cuts.

Width mm	Length mm	Mount	No. in pack		Price in €
			pcs	Part number	
65	50	SLP	1	6 35 02 208 21 0	17,59
65	50	SLP	3	6 35 02 208 22 0	50,13
65	50	SLP	5	6 35 02 208 23 0	79,14
65	50	SLP	10	6 35 02 208 24 0	149,48
65	50	SLP	50	6 35 02 208 25 0	659,47
65	50	SL	1	6 35 02 229 21 0	14,49
65	50	SL	3	6 35 02 229 22 0	41,30
65	50	SL	5	6 35 02 229 23 0	65,21
65	50	SL	10	6 35 02 229 24 0	123,17
65	50	SL	50	6 35 02 229 25 0	543,38



**E-Cut precision saw blade**

Double-row Japan teeth for all wooden materials, plasterboard and soft plastics. The fastest cutting speed and maximum precision. Narrow, with waist for optimum cutting speed and good swarf removal.

Width mm	Length mm	Mount	No. in pack		Price in €
			pcs	Part number	
35	50	SL	1	6 35 02 126 21 0	14,35
35	50	SL	3	6 35 02 126 22 0	40,91
35	50	SL	5	6 35 02 126 23 0	64,60
35	50	SL	10	6 35 02 126 24 0	122,01
35	50	SL	50	6 35 02 126 25 0	538,26



**E-Cut precision saw blade**

Double-row Japan teeth for all wooden materials, plasterboard and soft plastics. The fastest cutting speed and maximum precision. Medium width for various uses.

Width mm	Length mm	Mount	No. in pack		Price in €
			pcs	Part number	
45	50	SLP	1	6 35 02 198 21 0	15,04
45	50	SLP	3	6 35 02 198 22 0	42,85
45	50	SLP	5	6 35 02 198 23 0	67,66
45	50	SLP	10	6 35 02 198 24 0	127,82
45	50	SLP	50	6 35 02 198 25 0	563,88



**E-Cut precision saw blade**

Double-row Japan teeth for all wooden materials, plasterboard and soft plastics. The fastest cutting speed and maximum precision. Wide shape for effective sawing.

Width mm	Length mm	Mount	No. in pack		Price in €
			pcs	Part number	
55	50	SLP	1	6 35 02 199 21 0	15,44
55	50	SLP	3	6 35 02 199 22 0	43,98
55	50	SLP	5	6 35 02 199 23 0	69,46
55	50	SLP	10	6 35 02 199 24 0	131,19
55	50	SLP	50	6 35 02 199 25 0	578,75



**E-Cut precision saw blade**

Double-row Japan teeth for all wooden materials, plasterboard and soft plastics. The fastest cutting speed and maximum precision. Extra wide shape for maximum cutting performance and long, straight cuts.

Width mm	Length mm	Mount	No. in pack		Price in €
			pcs	Part number	
65	50	SLP	1	6 35 02 127 21 0	15,83
65	50	SLP	3	6 35 02 127 22 0	45,11
65	50	SLP	5	6 35 02 127 23 0	71,23
65	50	SLP	10	6 35 02 127 24 0	134,55
65	50	SLP	50	6 35 02 127 25 0	593,61
65	50	SL	1	6 35 02 230 21 0	13,97
65	50	SL	3	6 35 02 230 22 0	39,81
65	50	SL	5	6 35 02 230 23 0	62,84
65	50	SL	10	6 35 02 230 24 0	118,70
65	50	SL	50	6 35 02 230 25 0	523,69



**E-Cut universal saw blade**

Bimetal with corrugated universal teeth. Wide range of applications for sheet metal up to 2 mm, aluminium profiles, copper pipes, wood, plasterboard and plastics. Narrow, with waist for optimum cutting speed and good swarf removal.

Width mm	Length mm	Mount	No. in pack		Price in €
			pcs	Part number	
28	60	SLP	1	6 35 02 151 21 0	15,70
28	60	SLP	3	6 35 02 151 22 0	44,71
28	60	SLP	5	6 35 02 151 23 0	70,56
28	60	SLP	10	6 35 02 151 24 0	133,14
28	50	SLP	50	6 35 02 151 25 0	587,72
28	55	SL	1	6 35 02 222 21 0	15,48
28	55	SL	3	6 35 02 222 22 0	44,11
28	55	SL	5	6 35 02 222 23 0	69,65
28	55	SL	10	6 35 02 222 24 0	131,55
28	55	SL	50	6 35 02 222 25 0	580,39



**E-Cut universal saw blade**

Bimetal with corrugated universal teeth. Wide range of applications for sheet metal up to 2 mm, aluminium profiles, copper pipes, wood, plasterboard and plastics. Medium width, with waist for optimum cutting speed and good swarf removal.

Width mm	Length mm	Mount	No. in pack		Price in €
			pcs	Part number	
44	60	SLP	1	6 35 02 152 21 0	16,58
44	60	SLP	3	6 35 02 152 22 0	47,25
44	60	SLP	5	6 35 02 152 23 0	74,60
44	60	SLP	10	6 35 02 152 24 0	140,92
44	60	SLP	50	6 35 02 152 25 0	621,72
44	55	SL	1	6 35 02 223 21 0	16,25
44	55	SL	3	6 35 02 223 22 0	46,33
44	55	SL	5	6 35 02 223 23 0	73,14
44	55	SL	10	6 35 02 223 24 0	138,16
44	55	SL	50	6 35 02 223 25 0	609,53

Oscillating multi-tool



**E-Cut fine saw blade**

Bimetal with fine teeth for sheet metal up to 2 mm, aluminium profiles, copper pipes. Also for fibreglass-reinforced plastic and other hard plastics. Extremely precise cuts which are very easy to control with particularly thin cutting line. Narrow, with waist for optimum cutting speed and good swarf removal.

Width mm	Length mm	Mount	No. in pack pcs	Part number	Price in €
30	50	SL	1	6 35 02 157 21 0	10,50
30	50	SL	3	6 35 02 157 22 0	29,93
30	50	SL	5	6 35 02 157 23 0	47,25
30	50	SL	10	6 35 02 157 24 0	89,25
30	50	SL	50	6 35 02 157 25 0	393,75



**Carbide saw blade**

Open teeth for perfect, clean cut edges in carbon fibre-reinforced plastic/fibreglass-reinforced plastic materials without delamination. Distortion-free, long, straight cuts at high cutting speed and with precision. Extra thin version. Cutting width approx. 1.2 mm. Segmented, ideal for working in corners and on edges without overcutting.

Ø mm	Mount	Part number	Price in €
90	SLP	6 35 02 187 21 0	38,85



**Diamond-coated saw blade**

Open teeth for perfect, clean cut edges in carbon fibre-reinforced plastic/fibreglass-reinforced plastic materials without delamination. Distortion-free, long, straight cuts at high cutting speed and with precision. Diamond coating for outstanding service life. Extra thin version. Cutting width approx. 1.2 mm. Segmented, ideal for working in corners and on edges without overcutting.

Ø mm	Mount	Part number	Price in €
90	SLP	6 35 02 188 21 0	78,82



**E-Cut carbide saw blade**

Gentle sawing with perfect, clean cut edges in carbon fibre-reinforced plastic/fibreglass-reinforced plastic materials without delamination. Particularly well suited to precise cut-outs and short cuts. Precise working into the corners and on edges.

Width mm	Length mm	Mount	Part number	Price in €
35	50	SLP	6 35 02 191 21 0	27,42



**E-Cut diamond saw blade**

Diamond coating for outstanding service life. Gentle sawing with perfect, clean cut edges in carbon fibre-reinforced plastic/fibreglass-reinforced plastic materials without delamination. Particularly well suited to precise cut-outs and short cuts. Precise working into the corners and on edges.

Width mm	Length mm	Mount	Part number	Price in €
35	50	SLP	6 35 02 193 21 0	44,55



**Best of Renovation accessory set**

34-part accessory set for a wide range of renovation jobs at a special price in a practical plastic storage box. Universal use for sawing, sanding, cutting and much more. Attractive savings over purchasing the items individually. Contents: E-Cut long-life saw blades (1 x 10 mm and 1 x 20 mm), E-Cut long-life saw blades (3 x 35 and 3 x 65 mm), E-Cut universal saw blades (1 x 28 mm and 1 x 44 mm), 1 segmented HSS saw blade, diameter 85 mm, 1 segmented carbide saw blade, diameter 90 mm, 1 carbide file 10 mm, 1 rigid short stopper knife, 1 unperforated triangular sanding pad, with sanding sheets 3 each of 60, 80, 120, 180 grit, 1 backing pad, diameter 115 mm with sanding sheets, 2 each of 60, 80, 180 grit.

Mount	Part number	Price in €
SLP	3 52 22 942 06 0	166,95

**Grinding**



**Best of Sanding accessory set**

61-part accessory set for all sanding work on corners and edges as well as medium to large surfaces in a practical plastic storage box. Attractive savings over purchasing the items individually. Contents: 1 x triangular unperforated sanding pad, with sanding sheets, 10 each of 60, 80, 120, 180 grit, 1 backing pad 115 mm in diameter with sanding sheets, 6 each of 60, 80, 180 grit, 1 triangular carbide rasp.

Mount	Part number	Price in €
SLP	3 52 22 942 04 0	61,95



**Sanding pad set, unperforated**

Standard version. Plastic carrier plate for preventing damage and marks on the workpiece. Triangular shape, hook and loop fastening.

Mount	No. in pack pcs	Part number	Price in €
SL	2	6 38 06 129 22 0	10,72



**Sanding pad set, flat**

For very narrow, flat openings (e.g. slats on cupboards, window shutters). Plastic carrier plate for preventing damage and marks on the workpiece. Triangular shape, flat version, hook and loop fastening.

Mount	No. in pack pcs	Part number	Price in €
SL	2	6 38 06 142 22 0	14,52



**Supersoft sanding pad**

For special areas of application such as touching up aluminium rims and paint repairs. Plastic carrier plate for preventing damage and marks on the workpiece. Only use with "Sanding sheets, super-soft". Triangular shape, super-soft version, hook and loop fastening.

Mount	No. in pack pcs	Part number	Price in €
SL	2	6 38 06 141 22 0	14,52



**Set of sanding sheets**

50 sanding sheets of various grits for the universal use of coarse to fine sanding on virtually all materials. High sanding capacity, little clogging and long service life guaranteed thanks to corundum abrasive grit and full bonding with artificial resins. Content: sanding sheets, 10 each of grit 60, 80, 120, 180 and 240, non-perforated, with hook and loop fastening. Better value than buying items separately.

Part number	Price in €
6 37 17 082 03 3	16,07





**Sanding sheets**

High sanding capacity, little clogging and long service life guaranteed thanks to corundum abrasive grit and full bonding with artificial resins. For universal use on virtually all materials. Non-perforated, hook and loop fastening.

Grain	No. in pack pcs	Part number	Price in €
36	5	6 37 17 086 04 8	4,17
40	5	6 37 17 081 04 6	3,86
60	5	6 37 17 082 04 9	3,86
80	5	6 37 17 083 04 3	3,86
100	5	6 37 17 084 04 1	3,86
120	5	6 37 17 085 04 5	3,86
150	5	6 37 17 087 04 2	3,86
180	5	6 37 17 088 04 0	3,86
220	5	6 37 17 089 04 4	3,86
240	5	6 37 17 090 04 6	3,86
36	50	6 37 17 086 01 0	23,31
40	50	6 37 17 081 01 8	16,07
60	50	6 37 17 082 01 1	16,07
80	50	6 37 17 083 01 5	16,07
100	50	6 37 17 084 01 3	16,07
120	50	6 37 17 085 01 7	16,07
150	50	6 37 17 087 01 4	16,07
180	50	6 37 17 088 01 2	16,07
220	50	6 37 17 089 01 6	16,07
240	50	6 37 17 090 01 8	16,07



**Sanding sheets, zirconium**

Excellent sanding capacity on extremely hard surfaces such as varnish (e.g. parquet paint) or metal. The sanding sheet for all floor covering work. Extremely sturdy paper quality thanks to extremely tough full bonding with artificial resins and high-quality zirconium corundum coating. Non-perforated, hook and loop fastening.

Grain	No. in pack pcs	Part number	Price in €
40	35	6 37 17 243 01 0	15,37
60	35	6 37 17 244 01 0	15,37
80	35	6 37 17 245 01 0	15,37



**Supersoft sanding sheets**

Special sanding sheets for machining aluminium rims, performing touch-up work on dust inclusions, dealing with paint runs, overspray on wood, plastic, metal, etc. Only to be used in conjunction with the sanding pad 6 38 06 141 02 6. Non-perforated, hook and loop fastening.

Grain	No. in pack pcs	Part number	Price in €
240	50	6 37 17 126 01 5	16,79
320	50	6 37 17 127 01 9	16,79
400	50	6 37 17 128 01 7	16,79
500	50	6 37 17 179 01 6	16,79



**Stone sanding sheets**

Specially for working with natural and artificial stone. Available up to grit 800 for a perfect surface finish in fine sanding. Non-perforated, hook and loop fastening.

Grain	No. in pack pcs	Part number	Price in €
40	50	6 37 17 120 01 4	18,39
80	50	6 37 17 121 01 3	16,89
120	50	6 37 17 122 01 6	16,43
220	50	6 37 17 123 01 0	16,43
320	50	6 37 17 124 01 8	16,43
400	50	6 37 17 125 01 2	16,43
600	50	6 37 17 175 01 7	16,43
800	50	6 37 17 176 01 0	16,43



**Sanding finger**

For use in very narrow and deep places, in channels, grooves, openings and folds. Also in mould-making, on concave forms and in convex forms. Plastic carrier plate for preventing damage and marks on the workpiece. Finger shape, hook and loop fastening.

Mount	No. in pack pcs	Part number	Price in €
SL	2	6 38 06 159 22 0	11,49



**Sanding sheets for sanding fingers**

With Velcro rapid attachment, fully bonded with artificial resin, high sanding capacity, corundum. For use on: wood, metal, soldered joints, fibreglass, plastic, paint, filler, leather.

Grain	No. in pack pcs	Part number	Price in €
40	20	6 37 17 184 01 2	5,36
60	20	6 37 17 185 01 6	5,36
80	20	6 37 17 186 01 9	5,36
100	20	6 37 17 187 01 3	5,36
120	20	6 37 17 188 01 1	5,36
150	20	6 37 17 189 01 5	5,36
180	20	6 37 17 190 01 7	5,36
220	20	6 37 17 191 01 6	5,36
240	20	6 37 17 192 01 9	5,36



**Profile grinding set**

22-part set for sanding in grooves and on outside radii. Contents: 1 holder with 6 different profile inserts. 1 x V-form for 90° angle, 1 x trapezium form for tongue-and-groove connections, 1 x straight form for profiles, 1 x convex form (large), 1 x concave and 1 x convex form (small) and sanding sheets, 5 each of 80, 120 and 180 grit.

Mount	Part number	Price in €
SLP	6 38 10 031 01 0	41,57



**Sandpaper for profile sanding set**

High sanding capacity, little clogging and long service life guaranteed thanks to corundum abrasive grit and full bonding with artificial resins. For universal use on virtually all materials, non-perforated.

Grain	No. in pack pcs	Part number	Price in €
80	25	6 37 17 217 01 6	8,67
120	25	6 37 17 218 01 4	8,67
180	25	6 37 17 219 01 8	8,67



**Sanding pad set, perforated**

Standard version for sanding with dust extraction. Plastic carrier plate for preventing damage and marks on the workpiece. Triangular shape, perforated version, hook and loop fastening.

Mount	No. in pack pcs	Part number	Price in €
SL	2	6 38 06 136 22 0	16,44



**Set of sanding sheets**

50 sanding sheets of various grits for the universal use of coarse to fine sanding on virtually all materials. High sanding capacity, little clogging and long service life guaranteed thanks to corundum abrasive grit and full bonding with artificial resins. Content: sanding sheets, 10 each of grit 60, 80, 120, 180, 240, perforated, for use with perforated sanding pad and dust extraction, hook and loop fastening. Better value than buying items separately.

Part number	Price in €
6 37 17 109 03 5	17,20

Oscillating multi-tool



**Sanding sheets, perforated**

High sanding capacity, little clogging and long service life guaranteed thanks to corundum abrasive grit and full bonding with artificial resins. For universal use on virtually all materials. Perforated, for use with perforated sanding pad and dust extraction, hook and loop fastening.

Grain	No. in pack pcs	Part number	Price in €
36	5	6 37 17 107 04 9	4,96
40	5	6 37 17 108 04 7	4,17
60	5	6 37 17 109 04 1	4,17
80	5	6 37 17 110 04 3	4,17
100	5	6 37 17 111 04 2	4,17
120	5	6 37 17 112 04 5	4,17
150	5	6 37 17 113 04 9	4,17
180	5	6 37 17 114 04 7	4,17
220	5	6 37 17 115 04 1	4,17
240	5	6 37 17 116 04 4	4,17
36	50	6 37 17 107 01 1	26,78
40	50	6 37 17 108 01 9	17,20
60	50	6 37 17 109 01 3	17,20
80	50	6 37 17 110 01 5	17,20
100	50	6 37 17 111 01 4	17,20
120	50	6 37 17 112 01 7	17,20
150	50	6 37 17 113 01 1	17,20
180	50	6 37 17 114 01 9	17,20
220	50	6 37 17 115 01 3	17,20
240	50	6 37 17 116 01 6	17,20



**Sanding sheets, zirconium**

Excellent sanding capacity on extremely hard surfaces such as varnish (e.g. parquet paint) or metal. The sanding sheet for all floor covering work. Extremely sturdy paper quality thanks to extremely tough full bonding with artificial resins and high-quality zirconium corundum coating. Perforated, for use with perforated sanding pad and dust extraction, hook and loop fastening.

Grain	No. in pack pcs	Part number	Price in €
40	35	6 37 17 236 01 0	16,45
60	35	6 37 17 237 01 0	16,45
80	35	6 37 17 238 01 0	16,45



**Sanding set**

For the efficient sanding of edge and corner areas and medium-sized surfaces. The alternative to eccentric or random sanders. No kick-back effect at edges. Easy to use, very good sanding capacity. Plastic carrier plate prevents damage and marks on the workpiece.

Scope of supply: 1 large perforated triangular sanding pad (edge length 130 mm), with perforated sanding sheets, 2 each of grit 60, 80, 180.

Mount	Part number	Price in €
SLP	6 38 06 204 21 0	29,88



**Sanding sheets, perforated**

Compatible with large triangular sanding pad with 130 mm edge length.

High sanding capacity, little clogging and long service life guaranteed thanks to corundum abrasive grit and full bonding with artificial resins. For universal use on virtually all materials. Perforated, for use with perforated sanding pad and dust extraction, hook and loop fastening.

Grain	No. in pack pcs	Part number	Price in €
40	16	6 37 17 292 02 0	10,61
60	16	6 37 17 293 02 0	10,61
80	16	6 37 17 294 02 0	10,61
120	16	6 37 17 295 02 0	10,61
180	16	6 37 17 296 02 0	10,61
240	16	6 37 17 297 02 0	10,61



**Set of sanding sheets**

16 sanding sheets of various grits for the universal use of coarse to fine sanding on virtually all materials. High sanding capacity, little clogging and long service life guaranteed thanks to corundum abrasive grit and full bonding with artificial resins. Content: sanding sheets for large triangular sanding pad (edge length 130 mm), 4 each of grit 60, 80, 120, 180, perforated, for use with and without dust extraction, hook and loop fastening. Better value than buying items separately.

Part number	Price in €
3 52 22 952 10 0	10,40



**Sanding sheets, zirconium**

Compatible with large triangular sanding pad with 130 mm edge length.

Excellent sanding capacity on extremely hard surfaces such as varnish (e.g. parquet paint) or metal. The sanding sheet for all floor covering work. Extremely sturdy paper quality thanks to extremely tough full bonding with artificial resins and high-quality zirconium corundum coating. Perforated, for use with perforated sanding pad and dust extraction, hook and loop fastening.

Grain	No. in pack pcs	Part number	Price in €
40	12	6 37 17 298 01 0	18,10
60	12	6 37 17 299 01 0	18,10
80	12	6 37 17 300 01 0	18,10



**Sanding sheet set, zirconium**

12 sanding sheets with excellent sanding capacity on extremely hard surfaces such as varnish (e.g. parquet paint) or metal. The sanding sheet for all floor covering work. Extremely sturdy paper quality thanks to extremely tough full bonding with artificial resins and high-quality zirconium corundum coating. Content: sanding sheets for large triangular sanding pad (edge length 130 mm), 4 each of grit 40, 60, 80, perforated, for use with and without dust extraction, hook and loop fastening. Better value than buying items separately.

Part number	Price in €
3 52 22 952 11 0	17,75



**Sanding set**

For quickly and cost-effectively sanding medium-sized surfaces. The alternative to eccentric or random sanders. No kick-back effect at edges. Easy to use, very good sanding capacity. Can be used with or without dust extraction. Plastic carrier plate for preventing damage and marks on the workpiece. Round shape, perforated version, hook and loop fastening. Scope of supply: 1 backing pad diameter 115 mm, with perforated sanding sheets, 2 each of grit 60, 80, 180.

Ø mm	Mount	Part number	Price in €
115	SLP	6 38 06 195 21 0	24,85



**Set of sanding sheets**

16 sanding sheets of various grits for the universal use of coarse to fine sanding on virtually all materials. High sanding capacity, little clogging and long service life guaranteed thanks to corundum abrasive grit and full bonding with artificial resins. Content: sanding sheets, 4 each of grit 60, 80, 120, 180, 115 mm diameter, perforated, for use with and without dust extraction, hook and loop fastening. Better value than buying items separately.

Part number	Price in €
6 37 17 227 01 0	10,61





**Sanding sheets**

High sanding capacity, little clogging and long service life guaranteed thanks to corundum abrasive grit and full bonding with artificial resins. For universal use on virtually all materials. 115 mm diameter, perforated, for use with and without dust extraction, hook and loop fastening.

Grain	No. in pack pcs	Part number	Price in €
40	16	6 37 17 230 02 0	10,61
60	16	6 37 17 227 02 0	10,61
80	16	6 37 17 228 02 0	10,61
120	16	6 37 17 229 01 0	10,61
180	16	6 37 17 231 02 0	10,61
240	16	6 37 17 232 01 0	10,61



**Sanding sheets, zirconium**

Excellent sanding capacity on extremely hard surfaces such as varnish (e.g. parquet paint) or metal. The sanding sheet for all floor covering work. Extremely sturdy paper quality thanks to extremely tough full bonding with artificial resins and high-quality zirconium corundum coating. 115 mm diameter, perforated, for use with and without dust extraction, hook and loop fastening.

Grain	No. in pack pcs	Part number	Price in €
40	12	6 37 17 233 01 0	18,10
60	12	6 37 17 234 01 0	18,10
80	12	6 37 17 235 01 0	18,10



**Sanding sheet set, zirconium**

12 sanding sheets with excellent sanding capacity on extremely hard surfaces such as varnish (e.g. parquet paint) or metal. The sanding sheet for all floor covering work. Extremely sturdy paper quality thanks to extremely tough full bonding with artificial resins and high-quality zirconium corundum coating. Content: sanding sheets, 4 each of grit 40, 60, 80, 115 mm diameter, perforated, for use with and without dust extraction, hook and loop fastening. Better value than buying items separately.

Part number	Price in €
6 37 17 233 02 0	18,10

**Cutting, filing**



**Carbide saw blade**

For cutting out damaged tile joints. Also for cutting slots in plaster, porous concrete and similar building materials and for cleaning and reworking deck joints. Not suited to very hard epoxy resin or cement joints. The cost-effective alternative to diamond tools. Segmented, ideal for working in corners and on edges without overcutting. Cutting width approx. 2.2 mm.

Ø mm	Mount	No. in pack pcs	Part number	Price in €
90	SLP	1	6 35 02 169 21 0	29,39
90	SLP	5	6 35 02 169 23 0	132,26
75	SL	1	6 35 02 118 21 0	24,75
75	SL	5	6 35 02 118 23 0	111,37



**Carbide saw blade**

For cutting out damaged tile joints. Also for cutting slots in plaster, porous concrete and similar building materials and for cleaning and reworking deck joints. The cost-effective alternative to diamond tools. Extra thin version. Cutting width approx. 1.2 mm. Segmented, ideal for working in corners and on edges without overcutting.

Ø mm	Mount	No. in pack pcs	Part number	Price in €
90	SLP	1	6 35 02 170 21 0	30,26
90	SLP	5	6 35 02 170 23 0	136,17
75	SL	1	6 35 02 125 21 0	24,75
75	SL	5	6 35 02 125 23 0	111,37



**Diamond-coated saw blade**

For cutting out marble, epoxy resin and trass joints. Excellent service life. Also suited to very hard epoxy resin or cement joints. The right choice for frequent use and challenging jobs. Segmented, ideal for working in corners and on edges without overcutting. Cutting width approx. 2.2 mm.

Ø mm	Mount	No. in pack pcs	Part number	Price in €
90	SLP	1	6 35 02 166 21 0	61,95
90	SLP	5	6 35 02 166 23 0	278,78
75	SL	1	6 35 02 114 21 0	52,40
75	SL	5	6 35 02 114 23 0	235,78



**Diamond-coated saw blade**

For cutting out marble, epoxy resin and trass joints. Excellent service life. Also suited to very hard epoxy resin or cement joints. The right choice for frequent use and challenging jobs. Extra thin version. Cutting width approx. 1.2 mm. Segmented, ideal for working in corners and on edges without overcutting.

Ø mm	Mount	No. in pack pcs	Part number	Price in €
75	SL	1	6 35 02 216 21 0	52,40
75	SL	5	6 35 02 216 23 0	235,78
90	SLP	1	6 35 02 217 21 0	61,95
90	SLP	5	6 35 02 217 23 0	278,78



**Carbide rasp**

For rough sanding of fillers, tile adhesive, concrete, stone and wood. Triangular shape, edge length of 80 mm, perforated, can also be used with dust extraction.

Mount	Part number	Price in €
SL	6 37 31 001 21 0	26,48



**Carbide rasp**

For rough sanding of fillers, tile adhesive, concrete, stone and wood. For use in very narrow and deep places, in channels, grooves, openings and folds. Also in mould-making, on concave forms and in convex forms and for artistic work. Finger shape, coating on both sides.

Mount	Part number	Price in €
SLP	6 37 31 002 21 0	33,71



**Tile joint cleaner**

For quickly and cost-effectively cleaning very dirty tile joints. The alternative to a costly, complete renovation. Suitable for all widths of tile joint.

Mount	No. in pack pcs	Part number	Price in €
SLP	2	6 37 19 011 22 0	19,41



**Cleaning block**

Rhombus for cleaning the carbide tools and diamond-coated tools.

Part number	Price in €
6 37 19 007 01 0	20,67



**Best of Tileworking accessory set**

3-part accessory set for bathroom restoration and renovation in a practical plastic storage box. Attractive savings over purchasing the items individually. Contents: 1 triangular carbide rasp, 1 segmented diamond saw blade, diameter 90 mm, 1 segmented carbide saw blade, diameter 90 mm, extra thin.

Mount	Part number	Price in €
SLP	3 52 22 942 07 0	86,30

Oscillating multi-tool



**Carbide file**

For deburring and filing on CFRP, fibreglass-reinforced plastic, plastics and wood. Especially suitable for cutting out small recesses.

Width mm	Length mm	Mount	Part number	Price in €
10	30	SLP	6 37 06 019 21 0	19,11



**Saw and file set FMM**

Ideal combination for cutting small recesses and working in tight spots, e.g. for numerous installation jobs, switch installation, model-building and more.

Supplied: E-Cut long-life saw blade, 1 each of 10 mm and 20 mm, 1 carbide file 10 mm.

Mount	Part number	Price in €
SLP	3 52 22 952 02 0	25,70

**Cutting, scraping**



**Fixed Scraper Blade**

Short version. For removing stubborn old paint, adhesive residues, carpets, tile adhesives and coats of underseal.

Mount	Part number	Price in €
SL	6 39 03 226 21 0	14,74



**Fixed Scraper Blade**

Long version. For removing stubborn old paint, adhesive residues, carpets, tile adhesives and coats of underseal.

Mount	Part number	Price in €
SLP	6 39 03 234 21 0	14,99



**Flexible Scraper Blade**

Short version. For removing silicone or acrylic joints in bathrooms and removing stickers.

Mount	Part number	Price in €
SL	6 39 03 165 21 0	7,99



**Multi-function knife**

For cutting carpet, PVC floors, cardboard, bitumen shingles and roofing fabric. With three cutting surfaces.

Mount	No. in pack pcs	Part number	Price in €
SL	1	6 39 03 251 21 0	19,85
SL	5	6 39 03 251 23 0	89,30



**Cutting blade**

For cutting away panelled deck sealant materials quickly and safely. Also ideal for difficult areas such as cabins, rails, gunwales, cleats, and curves.

Blade width mm	Mount	Part number	Price in €
3	SLP	6 39 03 200 21 0	32,73
4	SLP	6 39 03 201 21 0	32,73
5	SLP	6 39 03 202 21 0	32,73
6	SLP	6 39 03 233 21 0	32,73



**Cutting blade**

Mushroom-shaped, for cutting silicone and soft putty material and for separating insulation glass units.

Mount	No. in pack pcs	Part number	Price in €
SL	5	6 39 03 245 23 0	26,15



**HSS circular knife**

For universal cutting work in leather, plastic sheets, roofing fabric, cork etc.

Ø mm	Mount	Part number	Price in €
100	SLP	6 39 03 235 21 0	52,87

**Cleaning, polishing**



**Bristle fleece**

Bristle fleece for cleaning boat decks or cleaning/polishing anti-slip structures.

No. in pack pcs	Part number	Price in €
2	6 37 23 031 01 0	10,19



**Felt polishing pad**

For polishing up metal parts, and for polishing and decorative polishing of stone and stone products. Can also be used to work with gelcoats on boats. Plastic carrier plate for preventing damage and marks on the workpiece.

Burnishing compounds for the respective material are available from specialist retailers.

Mount	No. in pack pcs	Part number	Price in €
SL	2	6 38 06 140 22 0	29,10



**Felt polishing pad**

Felt polishing pad for polishing boat decks (gelcoat), chrome, stainless steel, aluminium, copper and copper alloys.

No. in pack pcs	Part number	Price in €
5	6 37 23 032 01 0	17,82



**Felt polishing pad**

Diameter 115 mm, with hook and loop fastening. Versatile in use, for polishing chrome, stainless steel, polycarbonate materials and gelcoat boat decks, for polishing up scratched paint and removing tempering colours on exhaust systems.

No. in pack pcs	Part number	Price in €
5	6 37 23 036 01 0	19,75



**Sanding sheets, foam backing**

for removing scratches from paintwork, gelcoat, acrylic and polycarbonate glazing, lacquers, wood with a clear lacquer, furniture etc. For the best surface quality. 115 mm diameter with foam lamination, hook and loop fastening. Perfect as stage prior to polishing with felt polishing pad and FEIN EXTRA polish.

Grain	No. in pack pcs	Part number	Price in €
500	5	6 37 17 246 01 0	13,59
1 000	5	6 37 17 247 01 0	13,59



**Polishing liquid**

FEIN polish EXTRA based on aluminium oxide for polishing gelcoat and removing scratches in vehicle paint.

Contents ml	Part number	Price in €
250	6 37 26 030 01 0	18,05



**General accessories**



**Table-top and drill jigs support**

Perfect for precision cut-outs: the FEIN MULTIMASTER can be clamped to a table or work bench and the work piece safely fed to it. Clamping in drill stands with a standard 43 mm dia. collar clamp is possible.

Part number	Price in €
9 26 02 083 01 0	45,70



**Dust extraction set**

2 perforated sanding pads; perforated sanding sheets, 5 each of grit 60, 80, 120; 1 extractor hood with suction pipe; 1 adapter; 2 felt seals. For MULTIMASTER FMM 350 Q / QSL.

Part number	Price in €
9 26 02 091 00 0	39,98



**Dust extraction set**

2 sanding pads, perforated; sanding sheets, perforated, 5 each of grit 60, 80, 120; 1 extractor hood with suction pipe; 2 hose sockets for hose connection with a diameter of 27 and 32 mm and 2 adapters for connecting to the most common household vacuum cleaners. FMM 250 / 250 Q, FMT 250 / 250Q, FMT 250 SL / 250 QSL

Part number	Price in €
9 26 02 092 00 0	49,13



**Cutting paste**

Lubricating agents for working on sheet metals.

Part number	Price in €
3 21 32 020 12 9	14,11



**Quick charger ALG 50**

For all FEIN Li-ion batteries. Charge time from 35 min.

Part number	Price in €
9 26 04 129 01 0	40,95



**Quick charger ALG 30**

For FEIN NiCd and Li-ion batteries. Charge time from 25 min.

Part number	Price in €
9 26 04 096 01 0	142,80



**Battery pack**

Li-ion with charge status indicator and FEIN SafetyCell Technology. Protects the battery and tool from overload, overheating and total discharge.

Current/ Voltages V	Capacity Ah	Part number	Price in €
12	2,5	9 26 04 168 02 0	30,45
18	5	9 26 04 173 02 0	103,95
18	2,5	9 26 04 171 02 0	72,45



**Work gloves**

Vibration-attenuating, certified according to EN 388/420, EN ISO 10819, EEC No. 0200, No. in pack 1 pair

Size	Part number	Price in €
9 L	3 21 73 003 00 3	72,18
10 XL	3 21 73 004 00 1	72,18
11 XXL	3 21 73 005 00 5	72,18



**Adapter for FEIN oscillator (up to 2004)**

Spacer ring and clamping screw for older FEIN MULTIMASTER models MSx 636, MSx 636-1 and MSxe 636 II. Up to 40% improved torque transfer thanks to positive-fit connection to Starlock mounting on accessory side. Flat clamping screw for working flush with the surface.

Part number	Price in €
3 52 22 927 05 0	10,61

**Case**



**Carrying case unfilled**

Plastic case with practical inner layout, tool and accessories not included. FMM 250 / 250 Q, FMT 250 / 250Q, FMT 250 SL / 250 QSL

Part number	Price in €
3 39 01 144 01 0	22,18



**Carrying case unfilled**

Plastic case with practical inner layout, tool and accessories not included. FMM 350 Q / QSL

Part number	Price in €
3 39 01 131 98 0	41,63



**Systainer Sys 1**

Plastic, inner dimensions: H 75 x W 383 x D 273 mm  
The tool-specific Systainer insert must be ordered separately.

Part number	Price in €
3 39 01 146 00 0	51,24

**Systainer insert for FMM 350 Q / QSL**

Part number	Price in €
3 39 04 491 00 0	8,77

**Sawing**



**E-Cut standard saw blade**  
Set teeth for all wood, plasterboard and plastic materials, high cutting quality and speed.  
Long, narrow shape for large plunge depths. With waist for optimum cutting speed and good swarf removal.

Width mm	Length mm	Mount	No. in pack pcs	Part number	Price in €
32	90	SLM	1	6 35 02 231 21 0	11,61
32	90	SLM	3	6 35 02 231 22 0	33,10
32	90	SLM	5	6 35 02 231 23 0	52,26
32	90	SLM	10	6 35 02 231 24 0	98,71
32	90	SLM	50	6 35 02 231 25 0	435,49



**E-Cut long-life saw blade**  
Bimetal with set wood teeth for all wood, plasterboard and plastic materials. Outstanding tool life, high cutting quality and speed. Extremely robust, not affected by nails (up to diameter of approx. 4 mm) in wood, masonry etc.  
Long, narrow shape for large plunge depths. With waist for optimum cutting speed and good swarf removal.

Width mm	Length mm	Mount	No. in pack pcs	Part number	Price in €
32	90	SLM	1	6 35 02 224 21 0	13,19
32	90	SLM	3	6 35 02 224 22 0	37,59
32	90	SLM	5	6 35 02 224 23 0	59,35
32	90	SLM	10	6 35 02 224 24 0	112,10
32	90	SLM	50	6 35 02 224 25 0	494,55



**E-Cut standard saw blade**  
Set teeth for all wood, plasterboard and plastic materials, high cutting quality and speed.  
Long, wide shape for large plunge depths and effective working. With waist for optimum cutting speed and good swarf removal.

Width mm	Length mm	Mount	No. in pack pcs	Part number	Price in €
42	78	SLM	1	6 35 02 202 21 0	12,06
42	78	SLM	3	6 35 02 202 22 0	34,37
42	78	SLM	5	6 35 02 202 23 0	54,26
42	78	SLM	10	6 35 02 202 24 0	102,50
42	78	SLM	50	6 35 02 202 25 0	452,24



**E-Cut long-life saw blade**  
Bimetal with set wood teeth for all wood, plasterboard and plastic materials. Outstanding tool life, high cutting quality and speed. Extremely robust, not affected by nails (up to diameter of approx. 4 mm) in wood, masonry etc.  
Long, wide shape for large plunge depths and effective working. With waist for optimum cutting speed and good swarf removal.

Width mm	Length mm	Mount	No. in pack pcs	Part number	Price in €
42	78	SLM	1	6 35 02 203 21 0	13,69
42	78	SLM	3	6 35 02 203 22 0	39,01
42	78	SLM	5	6 35 02 203 23 0	61,59
42	78	SLM	10	6 35 02 203 24 0	116,34
42	78	SLM	50	6 35 02 203 25 0	513,28



**Carbide saw blade**  
Open teeth for perfect, clean cut edges in carbon fibre-reinforced plastic/fibreglass-reinforced plastic materials without delamination. Distortion-free, long, straight cuts at high cutting speed and with precision.  
Extra thin version. Cutting width approx. 1.2 mm.

Ø mm	Mount	Part number	Price in €
105	SLM	6 35 02 215 21 0	44,55



**Diamond-coated saw blade**  
Open teeth for perfect, clean cut edges in carbon fibre-reinforced plastic/fibreglass-reinforced plastic materials without delamination. Distortion-free, long, straight cuts at high cutting speed and with precision.  
Diamond coating for outstanding service life. Extra thin version. Cutting width approx. 1.2 mm. Segmented, ideal for working in corners and on edges without overcutting.

Ø mm	Mount	Part number	Price in €
105	SLM	6 35 02 220 21 0	107,39



**E-Cut diamond saw blade**  
Diamond coating for outstanding service life. Gentle sawing with perfect, clean cut edges in carbon fibre-reinforced plastic/fibreglass-reinforced plastic materials without delamination. Particularly well suited to precise cut-outs and short cuts. Precise working into the corners and on edges.

Width mm	Length mm	Mount	Part number	Price in €
44	60	SLM	6 35 02 204 21 0	48,16



**Segment saw blade**  
For cutting out putty-mounted isolation glass.

Mount	No. in pack pcs	Part number	Price in €
SLM	2	6 39 03 244 22 0	63,01

**Cutting, filing**



**Carbide saw blade**  
For cutting out marble, epoxy resin and trass joints. Not suited to very hard epoxy resin or cement joints. The cost-effective alternative to diamond tools.  
Cutting width approx. 2,2 mm.

Ø mm	Mount	No. in pack pcs	Part number	Price in €
105	SLM	1	6 35 02 213 21 0	36,75
105	SLM	5	6 35 02 213 23 0	164,85



**Carbide saw blade**  
For cutting out very narrow marble, epoxy resin and trass joints. Not suited to very hard epoxy resin or cement joints. The cost-effective alternative to diamond tools.  
Extra thin version. Cutting width approx. 1.2 mm.

Ø mm	Mount	No. in pack pcs	Part number	Price in €
105	SLM	1	6 35 02 214 21 0	36,75
105	SLM	5	6 35 02 214 23 0	165,38



**Carbide saw blade**  
For cutting out marble, epoxy resin and trass joints. Not suited to very hard epoxy resin or cement joints. The cost-effective alternative to diamond tools.  
Segmented, ideal for working in corners and on edges without overcutting. Cutting width approx. 2.2 mm.

Mount	No. in pack pcs	Part number	Price in €
SLM	1	6 39 03 241 21 0	36,75
SLM	5	6 39 03 241 23 0	165,38



**Carbide saw blade**  
For cutting out very narrow marble, epoxy resin and trass joints. Not suited to very hard epoxy resin or cement joints. The cost-effective alternative to diamond tools.  
Extra thin version. Cutting width approx. 1.2 mm. Segmented, ideal for working in corners and on edges without overcutting.

Mount	No. in pack pcs	Part number	Price in €
SLM	1	6 39 03 240 21 0	36,75
SLM	5	6 39 03 240 23 0	165,38



**Diamond-coated saw blade**

For cutting out marble, epoxy resin and trass joints. Excellent service life. Also suited to very hard epoxy resin or cement joints. The right choice for frequent use and challenging jobs. Cutting width approx. 2,2 mm.

Ø mm	Mount	No. in pack pcs	Part number	Price in €
105	SLM	1	6 35 02 218 21 0	94,40
105	SLM	5	6 35 02 218 23 0	424,78



**Diamond-coated saw blade**

For cutting out marble, epoxy resin and trass joints. Excellent service life. Also suited to very hard epoxy resin or cement joints. The right choice for frequent use and challenging jobs. Extra thin version. Cutting width approx. 1.2 mm.

Ø mm	Mount	No. in pack pcs	Part number	Price in €
105	SLM	1	6 35 02 219 21 0	94,40
105	SLM	5	6 35 02 219 23 0	424,78



**Cutting blade**

Universal blade for virtually all expansion joints. Straight. Width 30 mm, cutting depth 60 mm.

Mount	No. in pack pcs	Part number	Price in €
SLM	5	6 39 03 236 23 0	21,24



**Diamond-coated saw blade**

For cutting out marble, epoxy resin and trass joints. Excellent service life. Also suited to very hard epoxy resin or cement joints. The right choice for frequent use and challenging jobs. Segmented, ideal for working in corners and on edges without overcutting. Cutting width approx. 2.2 mm.

Mount	No. in pack pcs	Part number	Price in €
SLM	1	6 39 03 243 21 0	68,25
SLM	5	6 39 03 243 23 0	307,13



**Diamond-coated saw blade**

For cutting out marble, epoxy resin and trass joints. Excellent service life. Also suited to very hard epoxy resin or cement joints. The right choice for frequent use and challenging jobs. Extra thin version. Cutting width approx. 1.2 mm. Segmented, ideal for working in corners and on edges without overcutting.

Mount	No. in pack pcs	Part number	Price in €
SLM	1	6 39 03 242 21 0	68,25
SLM	5	6 39 03 242 23 0	307,13



**Diamond cleaning knife**

For cleaning mortar flanks before filling them in again. Straight. Width 31 mm, cutting depth 60 mm.

Mount	No. in pack pcs	Part number	Price in €
SLM	1	6 39 03 237 21 0	73,17
SLM	5	6 39 03 237 23 0	329,27



**Cleaning block**

Rhombus for cleaning the carbide tools and diamond-coated tools.

Part number	Price in €
6 37 19 007 01 0	20,67



**Carbide rasp**

For rough sanding of fillers, tile adhesive, concrete, stone and wood. For particularly good cutting speed and efficient machining of several square metres. Triangular shape, large version, edge length of 110 mm, perforated, can also be used with dust extraction.

Mount	Part number	Price in €
SLM	6 37 31 006 21 0	26,48



**Cutting blade**

Straight, very long shape, for very deep joints.

Cutting depth mm	Mount	No. in pack pcs	Part number	Price in €
90	SLM	1	6 39 03 238 21 0	21,32



**Cutting blade**

Straight, long shape, for deep joints.

Cutting depth mm	Mount	No. in pack pcs	Part number	Price in €
70	SLM	5	6 39 03 239 23 0	68,15



**Cutting tool**

For making grooves in rigid foam panels for electrical, wall and underfloor heating. StarlockMax fitting, can be used on all multi-function tools with suitable fitting. With adapter, suitable for all FEIN SUPERCUT before 04/16 too.

Cutting depth mm	Width mm	Cutting width mm	Mount	No. in pack pcs	Part number	Price in €
6,5	50	13	SLM	2	6 39 03 246 22 0	40,01



**Cutting tool**

For making grooves in rigid foam panels for electric cables. StarlockMax fitting, can be used on all multi-function tools with suitable fitting. With adapter, suitable for all FEIN SUPERCUT before 04/16 too.

Width mm	Immersion mm	Ø mm	Mount	No. in pack pcs	Part number	Price in €
50	12		SLM	2	6 39 03 247 22 0	40,01



**Cutting tool**

For making grooves in rigid foam panels for 1/2" and 3/4" hot water pipes and for empty pipes for electrical installation. Automatic fixing of laid pipes. Simple, quick and safe to use. StarlockMax fitting, can be used on all multi-function tools with suitable fitting. With adapter, suitable for all FEIN SUPERCUT before 04/16 too.

Width mm	Immersion mm	Ø mm	Mount	No. in pack pcs	Part number	Price in €
50	22		SLM	2	6 39 03 248 22 0	40,01

**General accessories**



**Device for dust extract**

For cutting and sawing applications with diamond-coated tools or E-Cut saw blades. Suitable for FEIN SUPERCUT FSC 500 QSL and AFSC 18 QSL.

Part number	Price in €
3 21 33 021 01 0	62,72



**Additional handle**

For improved handling of the FSC 500 QSL during long periods of continuous use. Can also be used in conjunction with the extraction device 3 21 33 021 01 0.

Part number	Price in €
3 21 19 148 02 0	41,01



**Accessory sets**



**Accessory set for interior construction work with wood**  
 27-part accessory set with extensive range of saw blades, especially for fast, precise sawing in all kinds of installation work. Identical to the scope of the professional set for interior work with wood. Attractive savings over purchasing the items individually. Contents: 5 E-CUT long-life saw blades (1 each of form 183, 160, 161, 201, 203), 2 E-CUT precision BIM saw blades (1 each of form 205, 208), 2 E-CUT universal saw blades (1 each of form 151, 152), 1 HSS bimetal saw blade for wood, diameter 100 mm, 1 depth stop, suitable for all saw blades, 1 triangular unperforated sanding pad, sanding sheets, 5 each of 80, 120, 180 grit.

Mount	Part number	Price in €
SLM	3 52 22 946 01 0	170,22



**Accessory set for repairing/replacing windows**  
 23-part accessory set with extensive range of accessories, especially for removing old windows and replacing putty-mounted insulating glass. Identical to the scope of the professional set for window repair and replacement. Attractive savings over purchasing the items individually. Contents: 1 E-CUT long-life saw blade (form 203), 1 E-CUT universal saw blade (form 152), 1 HSS bimetal saw blade for wood, diameter 100 mm, 1 HSS bimetal saw blade for metal, diameter 100 mm, 1 depth stop, suitable for all saw blades, 1 mushroom-shaped cutter blade (form 245), 1 segment saw blade (form 244), 1 triangular unperforated sanding pad, sanding sheets, 5 each of 80, 120, 180 grit.

Mount	Part number	Price in €
SLM	3 52 22 946 02 0	170,22



**Accessory set for tile restoration/bathroom renovation**  
 8-part accessory set with extensive range of accessories, especially for the perfect cutting-out of tiles and the removal of tile joints in bathroom renovation. Identical to the scope of the professional set for tile restoration / bathroom renovation. Attractive savings over purchasing the items individually. Contents: E-CUT universal saw blades (1 each of form 151, 152), 1 carbide saw blade, diameter 105 mm (form 214), 1 segmented diamond saw blade (form 243), 1 mushroom-shaped cutter blade (form 245), 1 long rigid stopper knife, triangular carbide rasps (1 each of 80 mm, 110 mm).

Mount	Part number	Price in €
SLM	3 52 22 946 03 0	170,22



**Accessory set for heating/sanitary installation**  
 9-part accessory set with extensive range of accessories, especially for key applications in sanitary repairs. Identical to the scope of the professional set for heating / sanitary installation. Attractive savings over purchasing the items individually. Contents: E-CUT universal saw blades (1 each of form 151, 152), 1 segmented diamond saw blade (form 243), 1 cutter blade, 1 long rigid stopper knife, 1 triangular carbide rasp (110 mm), cutting tool (1 each of form 246, 247, 248), 1 cutter blade (form 239).

Mount	Part number	Price in €
SLM	3 52 22 946 04 0	170,22



	FEIN SUPERCUT FSC 2.0 Q	FEIN SUPERCUT FSC 2.0 Q for repairing/re- placing windows	FEIN SUPERCUT FSC 2.0 Q for interior work with wood	FEIN SUPERCUT FSC 2.0 Q for tile restoration/ bathroom renova- tion	FEIN SUPERCUT FSC 2.0 Q for heating/sani- tary installation	FEIN SUPERCUT FSC 2.0 X for grout renewal	
	The powerful oscillator with quick clamping system for interior fitting and renovation.	The most powerful system for interior work and renovation with special accessories for dismantling old windows and replacing putty-mounted insulating glass.	The most powerful system for interior work and renovation with special accessories for fast and precise sawing work when fitting wood.	The most powerful system for interior work and renovation with special accessories for perfect removal of tiles and joints in bathroom renovation.	The most powerful system for interior work and renovation with special accessories for the key applications in sanitary repairs.	The most powerful system for interior work and renovation with special accessories for grout renewal.	
<b>Page</b>	232	232	232	233	233	233	
<b>Technical features</b>	Input	400 W	400 W	400 W	400 W	400 W	
	Output	220 W	220 W	220 W	220 W	220 W	
	Oscillations	11 000 - 18 500 1/min	11 000 - 18 500 1/min	11 000 - 18 500 1/min	11 000 - 18 500 1/min	11 000 - 18 500 1/min	11 000 - 18 500 1/min
	Amplitude	2 x 2,0°	2 x 2,0°	2 x 2,0°	2 x 2,0°	2 x 2,0°	2 x 2,0°
	Weight according to EPTA	1,45 kg	1,45 kg	1,45 kg	1,45 kg	1,45 kg	1,25 kg
	Cable with plug	5 m	5 m	5 m	5 m	5 m	5 m
	Tool Holder	Hexagon	Hexagon	Hexagon	Hexagon	Hexagon	Hexagon
	Tool change	QuickIN	QuickIN	QuickIN	QuickIN	QuickIN	Manual with screw, hexagon socket

Oscillating multi-tool



**FEIN SUPERCUT FSC 2.0 Q**

The powerful oscillator with quick clamping system for interior fitting and renovation.



For accessories, see page 234

Input	W	400
Output	W	220
Oscillations	1/min	11 000 - 18 500
Tool Holder		Hexagon
Tool change		QuickIN
Amplitude		2 x 2,0°
Cable with plug	m	5
Weight according to EPTA	kg	1,45
<b>Part number</b>		<b>7 236 36 50 01 0</b>
<b>EAN</b>		<b>4014586863122</b>
<b>Price in € [PC03]</b>		<b>471,45</b>

**FEIN benefits:**

- ▶ Convenient accessory changes without the need for extra tooling with the QuickIN clamping system.
- ▶ Hexagonal tool mounting for excellent transfer of torque between machine and tool
- ▶ Maximum quality and stability thanks to the use of ball / needle roller bearings and a motor and gearbox designed for continuous use at high load.
- ▶ Powerful oscillating motion for maximum work progress.
- ▶ Electronic speed control
- ▶ Wide range of accessories available for all applications.
- ▶ FEIN high-power motor for extraordinary performance

**Price includes:**

1 FEIN SUPERCUT FSC 2.0 Q, 1 Adapter Starlock, 1 plastic carrying case

**FEIN SUPERCUT FSC 2.0 Q for repairing/replacing windows**

The most powerful system for interior work and renovation with special accessories for dismantling old windows and replacing putty-mounted insulating glass.



For accessories, see page 234

Input	W	400
Output	W	220
Oscillations	1/min	11 000 - 18 500
Tool Holder		Hexagon
Tool change		QuickIN
Amplitude		2 x 2,0°
Cable with plug	m	5
Weight according to EPTA	kg	1,45
<b>Part number</b>		<b>7 236 36 51 01 0</b>
<b>EAN</b>		<b>4014586862781</b>
<b>Price in € [PC03]</b>		<b>576,45</b>

**FEIN benefits:**

- ▶ Maximum quality and stability thanks to the use of ball / needle roller bearings and a motor and gearbox designed for continuous use at high load.
- ▶ Hexagonal tool mounting for excellent transfer of torque between machine and tool
- ▶ Convenient accessory changes without the need for extra tooling with the QuickIN clamping system.
- ▶ Cuts time required by up to 80%
- ▶ Extracting of old window frames without damaging the walls or the plaster
- ▶ Repair of the insulation windows without breaking the old panes

**Price includes:**

1 FEIN SUPERCUT CONSTRUCTION in a plastic tool case, 1 Cutter blade, mushroom shaped, 1 E-CUT long-life saw blade (shape 163), 1 HSS saw blade wood, 1 adapter and 2 tensioning elements, 1 sanding pad, 1 each E-CUT universal saw blades (form 147, 148), 1 depth stop, 1 HSS saw blade, cropped, Ø 100 mm, 5 Sanding sheets each grit size (K 80, 120, 180), 1 Adapter Starlock

**FEIN SUPERCUT FSC 2.0 Q for interior work with wood**

The most powerful system for interior work and renovation with special accessories for fast and precise sawing work when fitting wood.



For accessories, see page 234

Input	W	400
Output	W	220
Oscillations	1/min	11 000 - 18 500
Tool Holder		Hexagon
Tool change		QuickIN
Amplitude		2 x 2,0°
Cable with plug	m	5
Weight according to EPTA	kg	1,45
<b>Part number</b>		<b>7 236 36 52 01 0</b>
<b>EAN</b>		<b>4014586862798</b>
<b>Price in € [PC03]</b>		<b>576,45</b>

**FEIN benefits:**

- ▶ Hexagonal tool mounting for excellent transfer of torque between machine and tool
- ▶ Convenient accessory changes without the need for extra tooling with the QuickIN clamping system.
- ▶ Maximum quality and stability thanks to the use of ball / needle roller bearings and a motor and gearbox designed for continuous use at high load.
- ▶ Powerful oscillating motion for maximum work progress
- ▶ Can also be converted to a delta sander
- ▶ Clean cuts even by hand; no clamping of the workpiece necessary

**Price includes:**

1 FEIN SUPERCUT CONSTRUCTION in a plastic tool case, 4 E-CUT long-life saw blades (shape 162, 163, 164, 165), 1 HSS saw blade wood, 1 each E-CUT universal saw blades (form 147, 148), 5 Sanding sheets each grit size (K 80, 120, 180), 1 adapter and 2 tensioning elements, 4 E-CUT precision saw blades (form 119, 120, 121, 122), 1 sanding pad, 1 depth stop, 1 Adapter Starlock



**FEIN SUPERCUT FSC 2.0 Q for tile restoration/bathroom renovation**

The most powerful system for interior work and renovation with special accessories for perfect removal of tiles and joints in bathroom renovation.



For accessories, see page 234

Input	W	400
Output	W	220
Oscillations	1/min	11 000 - 18 500
Tool Holder		Hexagon
Tool change		QuickIN
Amplitude		2 x 2,0°
Cable with plug	m	5
Weight according to EPTA	kg	1,45
<b>Part number</b>		<b>7 236 36 53 01 0</b>
<b>EAN</b>		<b>4014586862804</b>
<b>Price in € [PC03]</b>		<b>576,45</b>

**FEIN benefits:**

- ▶ Maximum quality and stability thanks to the use of ball / needle roller bearings and a motor and gearbox designed for continuous use at high load.
- ▶ Convenient accessory changes without the need for extra tooling with the QuickIN clamping system.
- ▶ Hexagonal tool mounting for excellent transfer of torque between machine and tool
- ▶ Also ideal for all fitting work
- ▶ Minimal dirt and dust

**Price includes:**

1 FEIN SUPERCUT CONSTRUCTION in a plastic tool case, 1 Cutter blade, mushroom shaped, 1 adapter and 2 tensioning elements, 1 carbide segment blade (form 224), 1 each E-CUT universal saw blades (form 147, 148), 1 Segment blade, diamond-coated, (form 162), 2 Rasps, carbide-coated, triangular, perforated for dust extractor, 1 Stopper knife, 1 Adapter Starlock

**FEIN SUPERCUT FSC 2.0 Q for heating/sanitary installation**

The most powerful system for interior work and renovation with special accessories for the key applications in sanitary repairs.



For accessories, see page 234

Input	W	400
Output	W	220
Oscillations	1/min	11 000 - 18 500
Tool Holder		Hexagon
Tool change		QuickIN
Amplitude		2 x 2,0°
Cable with plug	m	5
Weight according to EPTA	kg	1,45
<b>Part number</b>		<b>7 236 36 56 01 0</b>
<b>EAN</b>		<b>4014586862828</b>
<b>Price in € [PC03]</b>		<b>576,45</b>

**FEIN benefits:**

- ▶ Hexagonal tool mounting for excellent transfer of torque between machine and tool
- ▶ Maximum quality and stability thanks to the use of ball / needle roller bearings and a motor and gearbox designed for continuous use at high load.
- ▶ Convenient accessory changes without the need for extra tooling with the QuickIN clamping system.
- ▶ Also ideal for all fitting work
- ▶ Minimal dirt and dust

**Price includes:**

1 FEIN SUPERCUT CONSTRUCTION in a plastic tool case, 1 of each cutting tool (12, 13 and 22 mm), 1 Cutter blade, straight, long (form 116), 1 adapter and 2 tensioning elements, 1 carbide-coated rasp, triangular, perforated for dust extraction, 1 Stopper knife, 1 each E-CUT universal saw blades (form 147, 148), 1 Segment blade, diamond-coated, (form 162), 1 Adapter Starlock

**FEIN SUPERCUT FSC 2.0 X for grout renewal**

The most powerful system for interior work and renovation with special accessories for grout renewal.



For accessories, see page 234

Input	W	400
Output	W	220
Oscillations	1/min	11 000 - 18 500
Tool Holder		Hexagon
Tool change		Manual with screw, hexagon socket
Amplitude		2 x 2,0°
Cable with plug	m	5
Weight according to EPTA	kg	1,25
<b>Part number</b>		<b>7 236 38 61 00 0</b>
<b>EAN</b>		<b>4014586876351</b>
<b>Price in € [PC03]</b>		<b>618,45</b>

**FEIN benefits:**

- ▶ Hexagonal tool mounting for excellent transfer of torque between machine and tool
- ▶ Maximum quality and stability thanks to the use of ball / needle roller bearings and a motor and gearbox designed for continuous use at high load.
- ▶ Ergonomic design for fatigue-free working
- ▶ Vibration-attenuating bail handle for minimising physical fatigue
- ▶ Dust extraction device, attachable without tools

**Price includes:**

1 Cutter blade, straight, long (form 116), 1 Vibration-attenuating bail handle, 1 cleaning block, 5 Cutter blades, straight (form 117), 1 FEIN SUPERCUT CONSTRUCTION in metal tool case, 1 dust extraction device, 2 Cleaning knives, diamond-coated, straight (form 161)

**Sawing**



**Saw blades**

HSS, with fine teeth for precise cutting. Universal use on sheet metal of up to approx. 1 mm, can be doubled in plastics.

Ø mm	No. in pack pcs	Part number	Price in €
63	2	6 35 02 102 01 6	36,32
63	5	6 35 02 102 07 0	86,05
80	2	6 35 02 103 01 0	38,07
80	5	6 35 02 103 05 0	90,20



**Saw blades**

HSS, cranked, countersunk clamping screw for flush working.

Ø mm	No. in pack pcs	Part number	Price in €
85	1	6 35 02 177 01 0	40,98
85	5	6 35 02 177 05 0	184,39
100	1	6 35 02 178 01 0	42,66
100	5	6 35 02 178 05 0	191,96



**Segment saw blade**

HSS, cranked, countersunk clamping screw for flush working.

Ø mm	No. in pack pcs	Part number	Price in €
100	1	6 35 02 196 01 0	42,66
100	5	6 35 02 196 05 0	191,96



**Best of E-Cut accessory set XXL**

Includes 10 different E-Cut saw blades at a special price. Contents: 2 x E-Cut Long-Life 32 mm wide (shape 162), 3 x E-Cut Long-Life 42 mm wide (shape 163), 3 x E-Cut Long-Life 35 mm wide (shape 164), 2 x E-Cut Long-Life 65 mm wide (shape 165) in a practical plastic storage box.

Part number	Price in €
6 35 02 162 15 0	96,99



**Best of E-Cut accessory set**

Includes 6 different E-Cut saw blades. Content: E-Cut Universal (1x 28 mm and 1x 44 mm wide), 2x E-Cut Long-Life 35 mm wide, 2x E-Cut Long-Life 65 mm wide, in practical plastic storage box.

Part number	Price in €
6 35 02 147 12 0	68,43



**E-Cut long-life saw blades**

Bi-metallic teeth, stepped, high cutting speed. Extremely durable and robust. For hardwood, softwood and all other wooden materials - including those with nails. Also perfectly suited to plastics and plasterboard. Length 78 mm, form 162

Width mm	No. in pack pcs	Part number	Price in €
32	1	6 35 02 162 01 0	13,19
32	5	6 35 02 162 02 0	59,34
32	25	6 35 02 162 03 0	263,68



**E-Cut long-life saw blades**

Bi-metallic teeth, stepped, high cutting speed. Extremely durable and robust. For hardwood, softwood and all other wooden materials - including those with nails. Also perfectly suited to plastics and plasterboard. Length 78 mm, form 163

Width mm	No. in pack pcs	Part number	Price in €
42	1	6 35 02 163 01 0	13,69
42	5	6 35 02 163 02 0	61,59
42	25	6 35 02 163 03 0	273,75



**E-Cut long-life saw blades**

Bi-metallic teeth, stepped, high cutting speed. Extremely durable and robust. For hardwood, softwood and all other wooden materials - including those with nails. Also perfectly suited to plastics and plasterboard. Length 50 mm, form 164

Width mm	No. in pack pcs	Part number	Price in €
35	1	6 35 02 164 01 0	14,03
35	5	6 35 02 164 02 0	63,14
35	25	6 35 02 164 03 0	280,60



**E-Cut long-life saw blades**

Bi-metallic teeth, stepped, high cutting speed. Extremely durable and robust. For hardwood, softwood and all other wooden materials - including those with nails. Also perfectly suited to plastics and plasterboard. Length 50 mm, form 165

Width mm	No. in pack pcs	Part number	Price in €
65	1	6 35 02 165 01 0	15,21
65	5	6 35 02 165 02 0	68,49
65	25	6 35 02 165 03 0	304,37



**E-Cut long-life saw blades**

Bi-metallic teeth, stepped, high cutting speed. Extremely durable and robust. For hardwood, softwood and all other wooden materials - including those with nails. Also perfectly suited to plastics and plasterboard. Length 30 mm, form 186

Width mm	No. in pack pcs	Part number	Price in €
10	1	6 35 02 186 01 0	8,26
10	5	6 35 02 186 02 0	37,20
10	25	6 35 02 186 03 0	165,36



**E-Cut long-life saw blades**

Bi-metallic teeth, stepped, high cutting speed. Extremely durable and robust. For hardwood, softwood and all other wooden materials - including those with nails. Also perfectly suited to plastics and plasterboard. Length 34 mm, form 185

Width mm	No. in pack pcs	Part number	Price in €
20	1	6 35 02 185 01 0	10,71
20	5	6 35 02 185 02 0	48,20
20	25	6 35 02 185 03 0	214,20



**E-Cut standard saw blades**

Crossed toothing for all wood, plasterboard, and plastics jobs. Length 78 mm, form 123

Width mm	No. in pack pcs	Part number	Price in €
32	1	6 35 02 123 01 8	11,61
32	5	6 35 02 123 04 6	52,25
32	25	6 35 02 123 03 0	232,22



**E-Cut standard saw blades**  
Crossed toothing for all wood, plasterboard, and plastics jobs.  
Length 78 mm, form 124

Width mm	No. in pack pcs	Part number	Price in €
42	1	6 35 02 124 01 6	12,06
42	5	6 35 02 124 04 4	54,26
42	25	6 35 02 124 03 8	241,19



**E-Cut standard saw blades**  
Crossed toothing for all wood, plasterboard, and plastics jobs.  
Length 50 mm, form 135

Width mm	No. in pack pcs	Part number	Price in €
35	1	6 35 02 135 01 9	12,18
35	5	6 35 02 135 03 1	54,80
35	25	6 35 02 135 02 5	243,55



**E-Cut standard saw blades**  
Crossed toothing for all wood, plasterboard, and plastics jobs.  
Length 50 mm, form 136

Width mm	No. in pack pcs	Part number	Price in €
65	1	6 35 02 136 01 2	13,16
65	5	6 35 02 136 03 4	59,19
65	25	6 35 02 136 02 8	263,04



**E-Cut precision saw blades**  
Double-row original Japan toothing, for top-precision cuts, and clean cutting edges even freely by hand  
Length 50 mm, form 119

Width mm	No. in pack pcs	Part number	Price in €
35	1	6 35 02 119 01 0	16,26
35	5	6 35 02 119 04 8	73,22
35	25	6 35 02 119 03 2	325,37



**E-Cut precision saw blades**  
Double-row original Japan toothing, for top-precision cuts, and clean cutting edges even freely by hand  
Length 50 mm, form 120

Width mm	No. in pack pcs	Part number	Price in €
45	1	6 35 02 120 01 2	16,71
45	5	6 35 02 120 04 0	75,18
45	25	6 35 02 120 03 4	334,15



**E-Cut precision saw blades**  
Double-row original Japan toothing, for top-precision cuts, and clean cutting edges even freely by hand  
Length 50 mm, form 121

Width mm	No. in pack pcs	Part number	Price in €
55	1	6 35 02 121 01 1	17,15
55	5	6 35 02 121 04 9	77,16
55	25	6 35 02 121 03 3	342,93



**E-Cut precision saw blades**  
Double-row original Japan toothing, for top-precision cuts, and clean cutting edges even freely by hand  
Length 50 mm, form 122

Width mm	No. in pack pcs	Part number	Price in €
65	1	6 35 02 122 01 4	17,59
65	5	6 35 02 122 04 2	79,14
65	25	6 35 02 122 03 6	351,72



**E-Cut precision BIM saw blade**  
Bimetal with double-row Japan teeth for all wooden materials, plasterboard and soft plastics. Improved tool life and robustness. The fastest cutting speed and maximum precision.  
Length 50 mm, form 209

Width mm	No. in pack pcs	Part number	Price in €
35	1	6 35 02 209 01 0	16,26
35	5	6 35 02 209 02 0	73,22
35	25	6 35 02 209 03 0	325,37



**E-Cut precision BIM saw blade**  
Bimetal with double-row Japan teeth for all wooden materials, plasterboard and soft plastics. Improved tool life and robustness. The fastest cutting speed and maximum precision.  
Length 50 mm, form 210

Width mm	No. in pack pcs	Part number	Price in €
45	1	6 35 02 210 01 0	16,71
45	5	6 35 02 210 02 0	75,18
45	25	6 35 02 210 03 0	334,15



**E-Cut precision BIM saw blade**  
Bimetal with double-row Japan teeth for all wooden materials, plasterboard and soft plastics. Improved tool life and robustness. The fastest cutting speed and maximum precision.  
Length 50 mm, form 211

Width mm	No. in pack pcs	Part number	Price in €
55	1	6 35 02 211 01 0	17,15
55	5	6 35 02 211 02 0	77,16
55	25	6 35 02 211 03 0	342,93



**E-Cut precision BIM saw blade**  
Bimetal with double-row Japan teeth for all wooden materials, plasterboard and soft plastics. Improved tool life and robustness. The fastest cutting speed and maximum precision.  
Length 50 mm, form 212

Width mm	No. in pack pcs	Part number	Price in €
65	1	6 35 02 212 01 0	17,59
65	5	6 35 02 212 02 0	79,14
65	25	6 35 02 212 03 0	351,72



**E-Cut universal saw blades**  
Bi-metal teeth, cranked, also suitable for radii, high speed cut, sheet metal (400 N/mm<sup>2</sup>) up to about 2 mm and plastics, aluminium profiles, copper pipes, wood, plasterboard, and almost all plastics.  
Length 60 mm, form 147

Width mm	No. in pack pcs	Part number	Price in €
28	1	6 35 02 147 01 5	15,78
28	5	6 35 02 147 02 1	71,04
28	25	6 35 02 147 03 7	315,74



**E-Cut universal saw blades**  
Bi-metal teeth, cranked, also suitable for radii, high speed cut, sheet metal (400 N/mm<sup>2</sup>) up to about 2 mm and plastics, aluminium profiles, copper pipes, wood, plasterboard, and almost all plastics.  
Length 60 mm, form 148

Width mm	No. in pack pcs	Part number	Price in €
44	1	6 35 02 148 01 3	16,58
44	5	6 35 02 148 02 9	74,60
44	25	6 35 02 148 03 5	331,58



**HSS saw blade wood**  
Ideal for long, straight cuts and for cutting out laid parquet or laminate flooring.  
Without depth stop

Width mm	No. in pack pcs	Part number	Price in €
100	1	6 35 02 179 01 0	50,82

Oscillating multi-tool

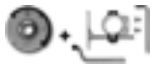

**HSS saw blade wood**

Ideal for long, straight cuts and for cutting out laid parquet or laminate flooring. With depth stop

Width mm	No. in pack pcs	Part number	Price in €
100	1	6 35 02 179 02 0	66,76



**Depth stop**

Depth stop for all saw blades. For accurate working at depth. Effective protection for blade and workpiece. Contents: 1 adapter for attachment to the machine, rotates freely through 360°. 1 depth stop, 1 depth-adjustable guide block. Can only be used with (A)FMM or (A)FSC.

Part number	Price in €
3 21 27 069 01 0	18,52



**M-Cut Saw Blade**

For cuts, cut-outs, and grooves in sheet metal, plastics, fibreglass, and carbon fibre-reinforced plastic; 2-pack. Wide

Width mm	Length mm	Part number	Price in €
30	50	6 35 02 138 01 4	15,62



**M-Cut Saw Blade**

For cuts, cut-outs, and grooves in sheet metal, plastics, fibreglass, and carbon fibre-reinforced plastic; 2-pack. Narrow

Width mm	Length mm	Part number	Price in €
10	50	6 35 02 158 01 0	18,27



**Carbide saw blade with open teeth**

For perfect, clean cut edges in carbon fibre-reinforced plastic/fibreglass-reinforced plastic materials without delamination. Distortion-free, long, straight cuts at high cutting speed. Can also be used with depth stop.

Width mm	Length mm	Part number	Price in €
1,2	105	6 35 02 189 01 0	43,68



**E-Cut carbide saw blade**

Gentle sawing with perfect, clean cut edges in carbon fibre-reinforced plastic/fibreglass-reinforced plastic materials without delamination. Particularly well suited to precise cut-outs and short cuts. Precise working into the corners and on edges. Can also be used with depth stop.

Width mm	Length mm	Part number	Price in €
35	50	6 35 02 192 01 0	26,88



**Diamond segment saw blade with open teeth**

For perfect, clean cut edges in carbon fibre-reinforced plastic/fibreglass-reinforced plastic materials without delamination. Distortion-free, long, straight cuts at very high cutting speed. Diamond coating for outstanding service life. Can also be used with depth stop.

Ø mm	Cutting width mm	Part number	Price in €
105	1,2	6 35 02 190 01 0	105,28



**E-Cut diamond saw blade**

Gentle sawing with perfect, clean cut edges in carbon fibre-reinforced plastic/fibreglass-reinforced plastic materials without delamination. Particularly well suited to precise cut-outs and short cuts. Diamond coating for outstanding service life. Precise working into the corners and on edges. Can also be used with depth stop.

Width mm	Length mm	Part number	Price in €
35	50	6 35 02 194 01 0	43,68



**E-Cut diamond saw blade**

Gentle sawing with perfect, clean cut edges in carbon fibre-reinforced plastic/fibreglass-reinforced plastic materials without delamination. Particularly well suited to precise cut-outs and short cuts. Diamond coating for outstanding service life. Precise working into the corners and on edges. Can also be used with depth stop.

Width mm	Length mm	Part number	Price in €
42	60	6 35 02 195 01 0	48,16



**Carbide file**

For deburring and filing cut-outs in fibreglass, CFRP, plastics and wood, length 50 mm

No. in pack pcs	Part number	Price in €
2	6 37 06 018 01 0	22,26



**Segment saw blade**

depressed, for removing panes of insulating glass installed on a putty bed, pack of 2

Part number	Price in €
6 39 03 166 01 6	63,01

**Rasping**



**Carbide rasp, triangular**

For rough sanding of filler, tile adhesives, concrete, stone and wood. For use with or without dust extractor. Large version for particularly good work progress and efficient machining of several square metres, edge length 110 mm.

Part number	Price in €
6 37 31 005 01 0	26,48

**Remove grouts**



**Carbide saw blade**

In comparison with the diamond version, the price is lower and the service life shorter. Stepped, cutting line approx. 2.2 mm, standard for all marble, epoxy resin and concrete trass joints.

Ø mm	No. in pack pcs	Part number	Price in €
105	1	6 35 02 172 01 0	36,75
105	5	6 35 02 172 02 0	165,38



**Carbide saw blade**

In comparison with the diamond version, the price is lower and the service life shorter. Extra thin version, cutting line approx. 1.2 mm, not suited to very hard epoxy resin or cement joints. Also suited to reworking deck joints.

Ø mm	No. in pack pcs	Part number	Price in €
105	1	6 35 02 173 01 0	36,75
105	5	6 35 02 173 02 0	165,38



**Carbide segment blade**

In comparison with the diamond version, the price is lower and the service life shorter. For corners and radii and for working without overcutting, cutting line approx. 2.2 mm for all marble and epoxy resin joints.

No. in pack pcs	Part number	Price in €
1	6 39 03 225 01 0	36,75
5	6 39 03 225 02 0	165,38



**Carbide segment blade**

In comparison with the diamond version, the price is lower and the service life shorter. For corners and radii and for working without overcutting, extra thin version, cutting line approx. 1.2 mm, cutting depth max. 10 mm. Not suited to very hard epoxy resin or cement joints.

No. in pack pcs	Part number	Price in €
1	6 39 03 224 01 0	36,75
5	6 39 03 224 02 0	165,38





**Diamond-coated saw blade**

Cutting line approx. 2.2 mm, standard design for all marble, epoxy resins and cement trass mortar.

Ø mm	No. in pack pcs	Part number	Price in €
80	1	6 35 02 115 01 1	65,42
80	5	6 35 02 115 03 0	294,37
105	1	6 35 02 167 01 0	94,40
105	5	6 35 02 167 02 0	424,78



**Diamond-coated saw blade**

Cutting line approx. 1.2 mm for extremely thin marble mortar joints. Not suitable for epoxy resin and cement trass mortar.

Ø mm	No. in pack pcs	Part number	Price in €
80	1	6 35 02 116 01 4	93,45
80	5	6 35 02 116 02 0	420,53
105	1	6 35 02 168 01 0	94,40
105	5	6 35 02 168 02 0	424,78



**Segment blade**

Diamond-coated, also for corners and radii and for working without overcutting. Cutting line approx. 2.2 mm, standard design for all marble, epoxy resins and cement trass mortar.

No. in pack pcs	Part number	Price in €
1	6 39 03 162 01 7	68,25
5	6 39 03 162 03 0	307,13



**Segment blade**

Diamond-coated, also for corners and radii and for working without overcutting. Cutting line approx. 1,2 mm, for extremely narrow marble joints. Cutting depth max. 10 mm. Not suitable for epoxy resin or trass cement joints.

No. in pack pcs	Part number	Price in €
1	6 39 03 196 01 3	68,25
5	6 39 03 196 02 0	307,13



**Cleaning block**

Rhombus for cleaning the carbide tools and diamond-coated tools.

Part number	Price in €
6 37 19 007 01 0	20,67



**Cutting blade**

Straight shape. Universal blade for almost all expansion sealants. Pack of 5

Part number	Price in €
6 39 03 117 01 5	21,24



**Cutting blade**

Straight, long, for very deep joints, pack of 5

Part number	Price in €
6 39 03 116 01 1	68,15



**Segment blade**

Segment form for V-cut from outside and for cuts in corners, 2-pack

Total length mm	Cut length mm	Part number	Price in €
73	30	6 39 03 132 01 0	47,63

**Scraping**



**Scraper blade**

for removing floor covering remains, underseal and residual bonding material, etc., pack of 2

Length mm	No. in pack pcs	Part number	Price in €
64	2	6 39 03 206 01 8	20,21
72	2	6 39 03 227 01 0	20,51

**Cutting**



**Cutting blade**

Mushroom-shaped, pack of 5, For cutting elastic silicon or acrylic connecting joints.

Part number	Price in €
6 39 03 128 01 2	15,41



**Cutting tool**

For making grooves in rigid foam panels for electrical, wall and underfloor heating.

Cutting depth mm	Width mm	Cutting width mm	Part number	Price in €
6,5	50	13	6 39 03 223 01 0	33,31



**Cutting tool**

For making grooves in rigid foam panels for electric cables.

Width mm	Immersion Ø mm	Part number	Price in €
50	12	6 39 03 222 01 0	33,31



**Cutting tool**

For making grooves in rigid foam panels for 1/2" and 3/4" hot water pipes and for empty pipes for electrical installation. Automatic fixing of laid pipes. Simple, quick and safe to use.

Width mm	Immersion Ø mm	Part number	Price in €
50	22	6 39 03 221 01 0	33,31



**Cutting tool**

Blade for 90° cut-out for bending Schlüter Kerdi-Boards®.

Cutting depth mm	Part number	Price in €
12,5	6 39 03 231 01 0	14,11
12,5	6 39 03 230 01 0	14,11
28	6 39 03 229 01 0	14,11
38	6 39 03 228 01 0	14,11

**General accessories**



**Device for dust extract**

FSC 2.0 Q For jobs with diamond-coated tools; tool-free mount. Hose connection Ø 32 mm.

Part number	Price in €
9 26 02 084 01 0	65,33



**Device for dust extract**

FSC 2.0 X

For jobs with diamond-coated tools; tool-free mount. Hose connection Ø 32 mm.

Part number	Price in €
9 26 02 075 01 8	64,26



**Dust extraction set**

For all sanding and rasping jobs with triangular sanding pad and carbide rasp. incl. 2 sanding pads, perforated; 5 of each type of sanding sheet, perforated, grit 60, 80, and 120; 1 extractor hood with suction tube; 2 hose nozzles for hose connection Ø 27 and 32 mm plus 2 adapters for connection to the most common domestic vacuum cleaners. For FSC 2.0 Q.

Part number	Price in €
9 26 02 074 01 4	50,34



**Work gloves**

Vibration-attenuating, certified according to EN 388/420, EN ISO 10819, EEC No. 0200, No. in pack 1 pair

Size	Part number	Price in €
9 L	3 21 73 003 00 3	72,18
10 XL	3 21 73 004 00 1	72,18
11 XXL	3 21 73 005 00 5	72,18



**Bail handle**

To reduce the vibrations and for better handling of the FEIN SUPERCUT during longer jobs. Can be used in connection with the dust extraction device 9 26 02 084 01 0.

Part number	Price in €
3 21 19 116 01 1	42,67



**Adapter for FEIN SUPERCUT without QuickIN**

Needed to hold accessories with an 8-star holder (e.g. rasps, sanding and polishing pads).

Part number	Price in €
3 06 05 114 01 1	23,10



**Adapter for FEIN SUPERCUT without QuickIN**

to mount Starlock accessories on older FEIN SUPERCUT units without QuickIN tool mounting (FSC 1.6, FSC 1.7). Adapter plus clamping screw.

Part number	Price in €
3 52 22 952 04 0	13,82



**Adapter for FEIN SUPERCUT with QuickIN**

Needed to hold accessories with an 8-star holder (e.g. rasps, sanding and polishing pads).

Part number	Price in €
6 37 33 005 01 0	21,87



**Adapter for FEIN SUPERCUT with QuickIN**

to mount Starlock accessories on older FEIN SUPERCUT units with QuickIN tool mounting (FSC 1.6 Q, FSC 1.7 Q, FSC 2.0 Q, AFSC 1.7 Q and AFSC 18). Adapter plus clamping screw.

Part number	Price in €
3 52 22 952 05 0	13,82



**Cutting paste**

Lubricating agents for working on sheet metals.

Part number	Price in €
3 21 32 020 12 9	14,11

**Accessory sets**



**Accessory set for interior construction work with wood**

Additional purchase for professional set for interior construction work with wood, consisting of: 1 HSS saw blade for wood (form 153); 4 E-CUT long-life saw blades (form 162, 163 and 164, 165); 4 E-CUT precision saw blades (form 119, 120 and 121, 122); 2 E-CUT universal saw blades (form 147, 148); 1 depth stop; 1 sanding pad; 5 each of sanding sheets, grain 80, 120, 180; 1 adapter and 2 tensioning elements

Part number	Price in €
6 39 03 167 66 0	169,05



**Accessory set for repairing/replacing windows**

Additional purchase for professional set for repairing/replacing windows, consisting of: 1 HSS saw blade, stepped (form 137); 1 HSS saw blade for wood (form 153); 1 E-CUT long-life saw blade (form 163); 2 E-CUT universal saw blades (form 147, 148); 1 segment saw blade (form 166); 1 cutter blade, mushroom-shaped (form 128); 1 depth stop; 1 sanding pad; 5 each of sanding sheets, grain 80, 120, 180; 1 adapter and 2 tensioning elements

Part number	Price in €
6 39 03 167 67 0	169,05



**Accessory set for tile restoration/bathroom renovation**

Additional purchase for professional set for tile restoration/bathroom renovation, consisting of: 1 segment blade, diamond-coated (form 162); 1 carbide segment blade (thin) (form 224); 1 blade, mushroom-shaped (form 128); 1 stopper knife; 2 carbide-coated rasps; 2 E-CUT universal saw blades (form 147, 148); 1 adapter and 1 tensioning element.

Part number	Price in €
6 39 03 167 58 0	169,05



**Accessory set for heating/sanitary installation**

Additional purchase for professional set for heating/sanitary installation, consisting of: 1 diamond-coated segment blade (form 162); 3 cut-out blades (12 mm, 13 mm, 22 mm); 1 cutter blade, straight (form 116); 2 E-CUT universal saw blades (form 147, 148); 1 stopper knife; 1 carbide-coated rasp; 1 adapter and 2 tensioning elements

Part number	Price in €
6 39 03 167 59 0	169,05





	FEIN SUPERCUT FSC 1.6	FEIN SUPERCUT FSC 1.6 Q	FEIN SUPERCUT FSC 1.6 Q Automotive Workshop	FEIN SUPERCUT FSC 1.6 Q Auto Glass	FEIN SUPERCUT FSC 1.6 Q Cargo	FEIN SUPERCUT MOtx 6-25	
	The powerful oscillator for the vehicle industry.	The powerful oscillator with quick clamping system for the vehicle industry.	The most powerful system for vehicle repairs with special accessories for versatile use in the automotive workshop.	The powerful system for vehicle repairs with special accessories for quick and safe removal of vehicle windows.	The most powerful system for vehicle repairs with special accessories for quick and professional removal of bonded windows on buses, lorries and rail vehicles.	The powerful pneumatic oscillator for cargo.	
<b>Page</b>	240	240	240	241	241	241	
<b>Technical features</b>	Input	400 W	400 W	400 W	400 W	400 W	
	Output	220 W	220 W	220 W	220 W	220 W	
	Oscillations	11 000 - 18 500 1/min	11 000 - 18 500 1/min	11 000 - 18 500 1/min	11 000 - 18 500 1/min	11 000 - 18 500 1/min	20 000 1/min
	Weight according to EPTA	1,25 kg	1,45 kg	1,45 kg	1,45 kg	1,45 kg	0,9 kg
	Cable with plug	5 m	5 m	5 m	5 m	5 m	
	Tool Holder	Hexagon	Hexagon	Hexagon	Hexagon	Hexagon	
	Tool change	Manual with screw, hexagon socket	QuickIN	QuickIN	QuickIN	QuickIN	
	Operating pressure						6,3 bar
	Air consumption						0,6 m <sup>3</sup> /min

Oscillating  
multi-tool

**FEIN SUPERCUT FSC 1.6**

The powerful oscillator for the vehicle industry.



For accessories, see page 242  
For cordless variant of tool, see page 40

Input	W	400
Output	W	220
Oscillations	1/min	11 000 - 18 500
Tool Holder		Hexagon
Tool change		Manual with screw, hexagon socket
Cable with plug	m	5
Weight according to EPTA	kg	1,25
<b>Part number</b>		<b>7 236 31 50 01 3</b>
<b>EAN</b>		<b>4014586859552</b>
<b>Price in € [PC03]</b>		<b>418,95</b>

**FEIN benefits:**

- ▶ Maximum quality and stability thanks to the use of ball / needle roller bearings and a motor and gearbox designed for continuous use at high load.
- ▶ Ideal for removing bonded panes and carrying out vehicle repairs.
- ▶ Large selection of accessories for cutting, sawing, grinding and scraping.
- ▶ Carbon brushes with self cut-off function.
- ▶ Hexagonal tool mounting with frictional connection between machine and tool.
- ▶ Continuously variable speed.
- ▶ FEIN high-power motor.
- ▶ Factory-recommended by respected vehicle manufacturers.

**Price includes:**

1 FEIN SUPERCUT FSC 1.6, 1 Mounting bolt (3 30 01 039 01 7), 1 key, 1 plastic carrying case, 1 sharpening stone (6 37 19 010 01 4)

**FEIN SUPERCUT FSC 1.6 Q**

The powerful oscillator with quick clamping system for the vehicle industry.



For accessories, see page 242  
For cordless variant of tool, see page 40

Input	W	400
Output	W	220
Oscillations	1/min	11 000 - 18 500
Tool Holder		Hexagon
Tool change		QuickIN
Cable with plug	m	5
Weight according to EPTA	kg	1,45
<b>Part number</b>		<b>7 236 42 50 01 0</b>
<b>EAN</b>		<b>4014586863191</b>
<b>Price in € [PC03]</b>		<b>418,95</b>

**FEIN benefits:**

- ▶ Convenient accessory changes without the need for extra tooling with the QuickIN clamping system.
- ▶ Ideal for removing bonded panes and carrying out vehicle repairs.
- ▶ Maximum quality and stability thanks to the use of ball / needle roller bearings and a motor and gearbox designed for continuous use at high load.
- ▶ FEIN high-power motor.
- ▶ Hexagonal tool mounting with frictional connection between machine and tool.
- ▶ Factory-recommended by leading automobile manufacturers.
- ▶ Carbon brushes with self cut-off function.
- ▶ Continuously variable speed.

**Price includes:**

1 FEIN SUPERCUT FSC 1.6 Q in plastic tool case, 1 sharpening stone (6 37 19 010 01 4), 1 protective cover for tool changes

**FEIN SUPERCUT FSC 1.6 Q Automotive Workshop**

The most powerful system for vehicle repairs with special accessories for versatile use in the automotive workshop.



For accessories, see page 242  
For cordless variant of tool, see page 40

Input	W	400
Output	W	220
Oscillations	1/min	11 000 - 18 500
Tool Holder		Hexagon
Tool change		QuickIN
Cable with plug	m	5
Weight according to EPTA	kg	1,45
<b>Part number</b>		<b>7 236 42 55 01 0</b>
<b>EAN</b>		<b>4014586862842</b>
<b>Price in € [PC03]</b>		<b>523,95</b>

**FEIN benefits:**

- ▶ Maximum quality and stability thanks to the use of ball / needle roller bearings and a motor and gearbox designed for continuous use at high load.
- ▶ Can be used for windscreens, side and rear glass panes.
- ▶ Convenient accessory changes without the need for extra tooling with the QuickIN clamping system.
- ▶ Other cutter blades available as accessories.
- ▶ High safety level with L-shaped blades.

**Price includes:**

1 FEIN SUPERCUT FSC 1.6 Q in plastic tool case, 2 L-shaped cutter blades, toothed (form 207), 2 U-shaped cutter blades, short side (1x form 079 and 1x form 101), 1 U-shaped cutter blade, reinforced (form 157), 1 protective cover for tool changes, 1 Spade-shaped scraper knife, with scratch-protective coating (form 129), 1 L-shaped cutter blade, toothed (form 208), 1 Straight cutter blade, Z-bend, with adjustable roller stop (form 143), 1 sharpening stone (6 37 19 010 01 4), 2 U-shaped cutter blades, short side (form 076), 1 stopper knife for removing underseal, 1 HSS saw blade (Ø 80 mm)

**FEIN SUPERCUT FSC 1.6 Q  
Auto Glass**

For accessories, see page 242  
For cordless variant of tool,  
see page 40

The powerful system for vehicle repairs with special accessories for quick and safe removal of vehicle windows.

Input	W	400
Output	W	220
Oscillations	1/min	11 000 - 18 500
Tool Holder		Hexagon
Tool change		QuickIN
Cable with plug	m	5
Weight according to EPTA	kg	1,45
<b>Part number</b>		<b>7 236 42 56 01 0</b>
<b>EAN</b>		<b>4014586862859</b>
<b>Price in € [PC03]</b>		<b>523,95</b>

**FEIN benefits:**

- ▶ Maximum quality and stability thanks to the use of ball / needle roller bearings and a motor and gearbox designed for continuous use at high load.
- ▶ Optimally compiled set for removing the most common types of vehicle windscreens.
- ▶ Convenient accessory changes without the need for extra tooling with the QuickIN clamping system.
- ▶ Other cutter blades available as accessories.
- ▶ Long service lives of the cutter blades.
- ▶ High safety level with L-shaped blades.

**Price includes:**

1 FEIN SUPERCUT FSC 1.6 Q in plastic tool case, 1 L-shaped cutter blade, toothed (form 209), 1 Straight cutter blade, Z-bend, toothed (form 081), 1 Straight cutter blade, Z-bend, with adjustable roller stop (form 143), 1 protective cover for tool changes, 2 U-shaped cutter blades, reinforced design, toothed (form 212), 3 L-shaped cutter blades, toothed (form 207), 1 sharpening stone (6 37 19 010 01 4), 2 L-shaped cutter blades, toothed (form 208), 1 each U-shaped cutter blade, reinforced design (forms 157 and 111)

**FEIN SUPERCUT FSC 1.6 Q  
Cargo**

For accessories, see page 242  
For cordless variant of tool,  
see page 40

The most powerful system for vehicle repairs with special accessories for quick and professional removal of bonded windows on buses, lorries and rail vehicles.

Input	W	400
Output	W	220
Oscillations	1/min	11 000 - 18 500
Tool Holder		Hexagon
Tool change		QuickIN
Cable with plug	m	5
Weight according to EPTA	kg	1,45
<b>Part number</b>		<b>7 236 42 57 01 0</b>
<b>EAN</b>		<b>4014586862866</b>
<b>Price in € [PC03]</b>		<b>523,95</b>

**FEIN benefits:**

- ▶ Convenient accessory changes without the need for extra tooling with the QuickIN clamping system.
- ▶ Maximum quality and stability thanks to the use of ball / needle roller bearings and a motor and gearbox designed for continuous use at high load.
- ▶ Sufficient capacity reserves for extreme loads in the cargo sector.
- ▶ Long service lives of the cutter blades.
- ▶ Other cutter blades available as accessories.
- ▶ Toothed blade designed specially for high module polyurethane adhesives.

**Price includes:**

1 FEIN SUPERCUT FSC 1.6 Q in plastic tool case, 1 Hook-shaped cutter blade, toothed (form 217), 1 Spade-shaped scraper knife, with scratch-protective coating (form 105), 1 sharpening stone (6 37 19 010 01 4), 1 traction cable with fastening, 2 L-shaped cutter blades, toothed (form 207), 2 Straight cutter blades, toothed (form 073), 1 Straight cutter blades, curved shape, Z-bend (form 072), 1 U-shaped cutter blade, toothed (form 212), 1 protective cover for tool changes, 2 straight cutter blades, Z-bend, toothed (form 081), 1 L-shaped cutter blade, toothed (form 209)

**FEIN SUPERCUT MOTlx 6-25**

For accessories, see page 242

The powerful pneumatic oscillator for cargo.

Operating pressure	bar	6,3
Air consumption	m <sup>3</sup> /min	0,6
Oscillations	1/min	20 000
Hose size Ø	mm	8
Weight according to EPTA	kg	0,9
<b>Part number</b>		<b>7 536 03 00 01 0</b>
<b>EAN</b>		<b>4014586861906</b>
<b>Price in € [PC03]</b>		<b>594,30</b>

**FEIN benefits:**

- ▶ Available with a comprehensive range of accessories for professional use in many industry sectors.
- ▶ Powerful oscillating motion with amplitude of 2 x 1.6 degrees for maximum work progress.
- ▶ Ideal for removing bonded panes from lorries, buses and rail vehicles.
- ▶ Small size.
- ▶ Supplied with inlet and outlet air hose.
- ▶ No air leaks, no oil misting in working area.
- ▶ Hexagonal tool mounting.

**Price includes:**

1 plastic carrying case, 2 keys, 1 pneumatic  
FEIN SUPERCUT MOTlx 6-25

**General accessories**



**Protective cover**  
For safe tool changes for SUPERCUT with QuickIN when opening and closing the clamping lever.

Part number	Price in €
3 21 74 011 00 0	6,31



**Sharpening stone**  
For sharpening blades before use to produce an optimum cut.

Part number	Price in €
6 37 19 010 01 4	10,63



**Cutting paste**  
Lubricating agents for working on sheet metals.

Part number	Price in €
3 21 32 020 12 9	14,11



**Work gloves**  
Vibration-attenuating, certified according to EN 388/420, EN ISO 10819, EEC No. 0200, No. in pack 1 pair

Size	Part number	Price in €
9 L	3 21 73 003 00 3	72,18
10 XL	3 21 73 004 00 1	72,18
11 XXL	3 21 73 005 00 5	72,18



**Adapter for FEIN SUPERCUT without QuickIN**  
Needed to hold accessories with an 8-star holder (e.g. rasps, sanding and polishing pads).

Part number	Price in €
3 06 05 114 01 1	23,10



**Adapter for FEIN SUPERCUT with QuickIN**  
Needed to hold accessories with an 8-star holder (e.g. rasps, sanding and polishing pads).

Part number	Price in €
6 37 33 005 01 0	21,87



**Adapter for FEIN SUPERCUT with QuickIN**  
to mount Starlock accessories on older FEIN SUPERCUT units with QuickIN tool mounting (FSC 1.6 Q, FSC 1.7 Q, FSC 2.0 Q, AFSC 1.7 Q and AFSC 18). Adapter plus clamping screw.

Part number	Price in €
3 52 22 952 05 0	13,82



**Adapter for FEIN SUPERCUT without QuickIN**  
to mount Starlock accessories on older FEIN SUPERCUT units without QuickIN tool mounting (FSC 1.6, FSC 1.7). Adapter plus clamping screw.

Part number	Price in €
3 52 22 952 04 0	13,82

**Automotive workshop accessories**



**Straight form**  
curved, Z-bend, as subsequent order for removal device 9 06 07 001 01 6, 2-pack.

Part number	Price in €
6 39 03 197 01 7	80,89



**Saw blades**  
HSS, with fine teeth for precise cutting. Universal use on sheet metal of up to approx. 1 mm, can be doubled in plastics.

Ø mm	No. in pack pcs	Part number	Price in €
63	2	6 35 02 102 01 6	36,32
63	5	6 35 02 102 07 0	86,05
80	2	6 35 02 103 01 0	38,07
80	5	6 35 02 103 05 0	90,20



**M-Cut Saw Blade**  
For cuts, cut-outs, and grooves in sheet metal, plastics, fibreglass, and carbon fibre-reinforced plastic; 2-pack.  
Wide

Width mm	Length mm	Part number	Price in €
30	50	6 35 02 138 01 4	15,62



**M-Cut Saw Blade**  
For cuts, cut-outs, and grooves in sheet metal, plastics, fibreglass, and carbon fibre-reinforced plastic; 2-pack.  
Narrow

Width mm	Length mm	Part number	Price in €
10	50	6 35 02 158 01 0	18,27



**Carbide file**  
For deburring and filing cut-outs in fibreglass, CFRP, plastics and wood, length 50 mm

No. in pack pcs	Part number	Price in €
2	6 37 06 018 01 0	22,26



**E-Cut universal saw blades**  
Bi-metal teeth, cranked, also suitable for radii, high speed cut, sheet metal (400 N/mm<sup>2</sup>) up to about 2 mm and plastics, aluminium profiles, copper pipes, wood, plasterboard, and almost all plastics. Length 60 mm, form 147

Width mm	No. in pack pcs	Part number	Price in €
28	1	6 35 02 147 01 5	15,78
28	5	6 35 02 147 02 1	71,04



**E-Cut universal saw blades**  
Bi-metal teeth, cranked, also suitable for radii, high speed cut, sheet metal (400 N/mm<sup>2</sup>) up to about 2 mm and plastics, aluminium profiles, copper pipes, wood, plasterboard, and almost all plastics. Length 60 mm, form 148

Width mm	No. in pack pcs	Part number	Price in €
44	1	6 35 02 148 01 3	16,58
44	5	6 35 02 148 02 9	74,60



**Straight form**  
suitable for round grooves in plastics. toothed, 2-pack.

Total length mm	Cut length mm	Part number	Price in €
56	35	6 39 03 073 01 1	48,58



**Straight form**  
Suitable for removal of chassis attachment parts.  
Z-bend, toothed, 2-pack.

Total length mm	Cut length mm	Part number	Price in €
120	60	6 39 03 081 01 3	68,68



**Scraper blade**  
for removing floor covering remains, underseal and residual bonding material, etc., pack of 2

Length mm	No. in pack pcs	Part number	Price in €
64	2	6 39 03 206 01 8	20,21
72	2	6 39 03 227 01 0	20,51



**Cutting blade**  
Mushroom-shaped, pack of 5, For cutting elastic silicon or acrylic connecting joints.

Part number	Price in €
6 39 03 128 01 2	15,41

**FEIN accessories for removing residual bonding beads**



**Scraper knife**  
Spade-shaped, with scratch-protective coating, 2-pack.

Total length mm	Cut length mm	Part number	Price in €
64	12	6 39 03 129 05 0	63,37
65	18	6 39 03 146 01 8	63,12
64	25	6 39 03 105 01 9	63,37



**Scraper knife**  
with cross cutter and scratch protective coating on front limit stop, 2-pack.

Cutting width mm	Part number	Price in €
13	6 39 03 113 01 6	63,37
25	6 39 03 131 01 7	63,37



**Scraper knife**  
with cross cutter, 2-pack.

Cutting width mm	Part number	Price in €
13	6 39 03 144 01 1	63,12



**Scraper knife set**  
consisting of: 1 each of spade-shaped scraper knife, with scratch-protective coating (forms 129/105).

Part number	Price in €
6 39 03 129 01 6	63,37



**Scraper knife set**  
consisting of: 1 each of scraper knife with cross cutter and scratch protective coating on front limit stop (form 113/131).

Part number	Price in €
6 39 03 113 02 2	63,37

**Vehicle glazing accessories**



**U-shaped**  
Ideal for removing glass from under the bonnet.  
short side, 2-pack

Cut length mm	Part number	Price in €
10	6 39 03 083 01 0	71,80
16	6 39 03 095 01 1	76,05
16	6 39 03 108 01 4	84,50
18	6 39 03 087 01 9	76,05
19,5	6 39 03 118 01 3	79,73
22	6 39 03 115 01 8	84,50
24	6 39 03 076 01 6	68,73
28	6 39 03 163 01 1	76,05
32	6 39 03 147 01 2	79,73
36	6 39 03 079 01 2	68,73
40	6 39 03 110 01 0	76,05
60	6 39 03 101 01 0	71,80
70	6 39 03 155 01 4	79,73



**U-shaped**  
Ideal for removing glass from under the bonnet.  
long side, 2-pack

Cut length mm	Part number	Price in €
18	6 39 03 127 01 4	84,50
32	6 39 03 114 01 4	84,50
32	6 39 03 191 01 1	76,05
45	6 39 03 154 01 0	76,05
52	6 39 03 153 01 2	71,80
60	6 39 03 107 01 6	79,73



**U-shaped**  
Ideal for removing glass from under the bonnet.  
reinforced design, 2-pack

Cut length mm	Part number	Price in €
60	6 39 03 157 01 1	71,80
95	6 39 03 111 01 9	79,73



**U-shaped**  
Ideal for removing glass from under the bonnet.  
reinforced design, toothed, 2-pack.

Cut length mm	Part number	Price in €
19	6 39 03 210 01 6	48,13
22,5	6 39 03 211 01 5	48,13
38	6 39 03 212 01 8	48,13



**L-shaped**  
toothed, 2-pack.

Cut length mm	Part number	Price in €
19	6 39 03 208 01 0	48,90
25,4	6 39 03 207 01 2	48,90
38	6 39 03 209 01 4	48,90



**Straight form**  
Pack of 2

Total length mm	Cut length mm	Part number	Price in €
56	26	6 39 03 121 01 8	63,37
90	40	6 39 03 176 01 5	48,58
145	35	6 39 03 194 01 6	79,73



**Straight form**  
Z-bend, 2-pack.

Total length mm	Cut length mm	Part number	Price in €
68	19	6 39 03 122 01 1	63,37
84	18	6 39 03 181 01 2	73,91
65	23	6 39 03 173 01 0	73,91
65	25	6 39 03 124 01 3	73,91
85	27	6 39 03 174 01 8	73,91
110	32	6 39 03 123 01 5	73,91
120	70	6 39 03 171 01 3	68,68



**Straight form**  
curved, 2-pack

Total length mm	Cut length mm	Part number	Price in €
65	14	6 39 03 120 01 9	63,37
75	16	6 39 03 104 01 5	58,11
75	35	6 39 03 103 01 7	42,78
75	35	6 39 03 109 01 8	47,53
75	35	6 39 03 172 01 6	47,53



**Straight form**  
curved, Z-bend, 2-pack

Total length mm	Cut length mm	Part number	Price in €
120	45	6 39 03 168 01 8	68,68
120	70	6 39 03 125 01 7	68,68



**Straight form**  
Z-bend, with rigid depth stop, 2-pack.

Total length mm	Cut length mm	Part number	Price in €
120	16	6 39 03 099 01 0	71,80
125	58	6 39 03 097 01 8	71,80



**Straight form**  
Z-bend, with adjustable depth stop, 2-pack

Total length mm	Cut length mm	Part number	Price in €
100	16-43	6 39 03 143 01 3	96,43
100	18-39	6 39 03 170 01 4	96,43
100	20-35	6 39 03 198 01 5	96,43
100	60-76	6 39 03 169 01 2	96,43

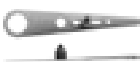

**Straight form**  
flat, with adjustable depth stop, 2-pack.

Total length mm	Cut length mm	Part number	Price in €
145	42-60	6 39 03 182 01 5	79,73



**Straight form**  
Z-bend, bent with rigid depth stop, 2-pack.

Total length mm	Cut length mm	Part number	Price in €
120	54	6 39 03 160 01 5	77,22



**Curved form**  
Z-bend, with rigid depth stop, 2-pack.

Total length mm	Cut length mm	Part number	Price in €
80	14	6 39 03 082 01 6	71,80
80	16	6 39 03 133 01 4	71,80
85	39	6 39 03 152 01 8	71,80



**Curved form**  
Z-bend, with adjustable depth stop, 2-pack

Total length mm	Cut length mm	Part number	Price in €
110	32-46	6 39 03 195 01 0	96,43

**Cargo accessories**



**L-shaped**  
toothed, 2-pack.

Cut length mm	Part number	Price in €
25,4	6 39 03 207 01 2	48,90
38	6 39 03 209 01 4	48,90



**Straight form**  
suitable for round grooves in plastics.  
toothed, 2-pack.

Total length mm	Cut length mm	Part number	Price in €
56	35	6 39 03 073 01 1	48,58



**Straight form**  
Suitable for removal of chassis attachment parts.  
Z-bend, toothed, 2-pack.

Total length mm	Cut length mm	Part number	Price in €
120	60	6 39 03 081 01 3	68,68



**Straight form**  
Z-bend, 2-pack.

Total length mm	Cut length mm	Part number	Price in €
120	60	6 39 03 216 01 7	67,34



**Straight form**  
Angle cutter, 2-pack.

Total length mm	Cut length mm	Part number	Price in €
85	65/8	6 39 03 177 01 9	70,39
83	35/20	6 39 03 203 01 3	70,39



**Curved form**  
Z-bend, 2-pack.

Total length mm	Cut length mm	Part number	Price in €
80	45	6 39 03 072 01 7	68,67



**U-shaped**  
with elongated traverse, 2-pack.

Cut length mm	Part number	Price in €
40	6 39 03 156 01 7	84,72



**Hook-shaped**  
toothed, 2-pack.

Cut length mm	Part number	Price in €
38	6 39 03 217 01 1	48,13



**Segment blade**  
Segment form for V-cut from outside and for cuts in corners,  
2-pack

Total length mm	Cut length mm	Part number	Price in €
73	30	6 39 03 132 01 0	47,63



**Traction cable**  
with grip. Use is recommended when cutting out from outside  
with L-shaped or hook-shaped cutter blade. Easier work and  
less effort when cutting out glass panes from problem spots on  
buses, commercial vehicles, trams and locomotives.

Part number	Price in €
9 26 02 030 01 4	16,07



**Work gloves**  
Vibration-attenuating, certified according to EN 388/420,  
EN ISO 10819, EEC No. 0200, No. in pack 1 pair

Size	Part number	Price in €
9 L	3 21 73 003 00 3	72,18
10 XL	3 21 73 004 00 1	72,18
11 XXL	3 21 73 005 00 5	72,18



**Bail handle**  
To reduce the vibrations and for better handling of the  
FEIN SUPERCUT during longer jobs. Can be used in connection  
with the dust extraction device 9 26 02 084 01 0.

Part number	Price in €
3 21 19 116 01 1	42,67

**Accessory sets**



**Automobile glazier accessory set**  
Consisting of: 3 L-shaped cutter blades, toothed (form 207);  
2 L-shaped cutter blades, toothed (form 208); 1 L-shaped cutter  
blade, toothed (form 209); 1 each of U-shaped cutter blade, re-  
inforced version (form 157 and 111); 2 U-shaped cutter blades,  
reinforced version, toothed (form 212); 1 straight cutter blade,  
Z-bend with adjustable stop roller (form 143); 1 straight cutter  
blade, Z-bend, toothed (form 081).

Part number	Price in €
6 39 03 167 38 3	199,67



**Automobile workshop accessories set**  
Consisting of: 2 U-shaped cutter blades, short side (form 076);  
2 U-shaped cutter blades, short side (1x form 079 and 1x form  
101); 2 L-shaped cutter blades, toothed (form 207); 1 L-shaped  
cutter blade, toothed (form 208); 1 U-shaped cutter blade,  
reinforced (form 157); 1 straight cutter blade, Z-bend, with  
adjustable stop roller (form 143); 1 shovel-shaped scraper blade,  
with scrape protection coating (form 129); 1 stopper knife;  
1 HSS saw blade (Ø 80 mm).

Part number	Price in €
6 39 03 167 25 7	199,67



**Accessory set for cargo**  
Subsequent order to Professional set Cargo consisting of:  
2 straight cutter blades, toothed (form 073), 1 straight cutter  
blade, Z-bend, toothed (form 081), 1 hook-shaped cutter blade,  
toothed (form 217), 1 curved cutter blade, Z-bend, (form 072),  
1 each of L-shaped cutter blade, toothed (forms 207 and 209),  
1 spade-shaped scraper knife, with scratch-protective coating  
(form 105), 1 traction cable, 1 depth stop

Part number	Price in €
6 39 03 167 32 0	199,67

**Accessories for AFSC 18**



**Quick charger ALG 50**  
For all FEIN Li-ion batteries. Charge time from 35 min.

Part number	Price in €
9 26 04 129 01 0	40,95



**Quick charger ALG 30**  
For FEIN NiCd and Li-ion batteries. Charge time from 25 min.

Part number	Price in €
9 26 04 096 01 0	142,80



**Battery pack**  
Li-ion with charge status indicator and FEIN SafetyCell  
Technology. Protects the battery and tool from overload,  
overheating and total discharge.

Current/ Volts	Capacity	Part number	Price in €
V	Ah		
18	5	9 26 04 173 02 0	103,95
18	2,5	9 26 04 171 02 0	72,45



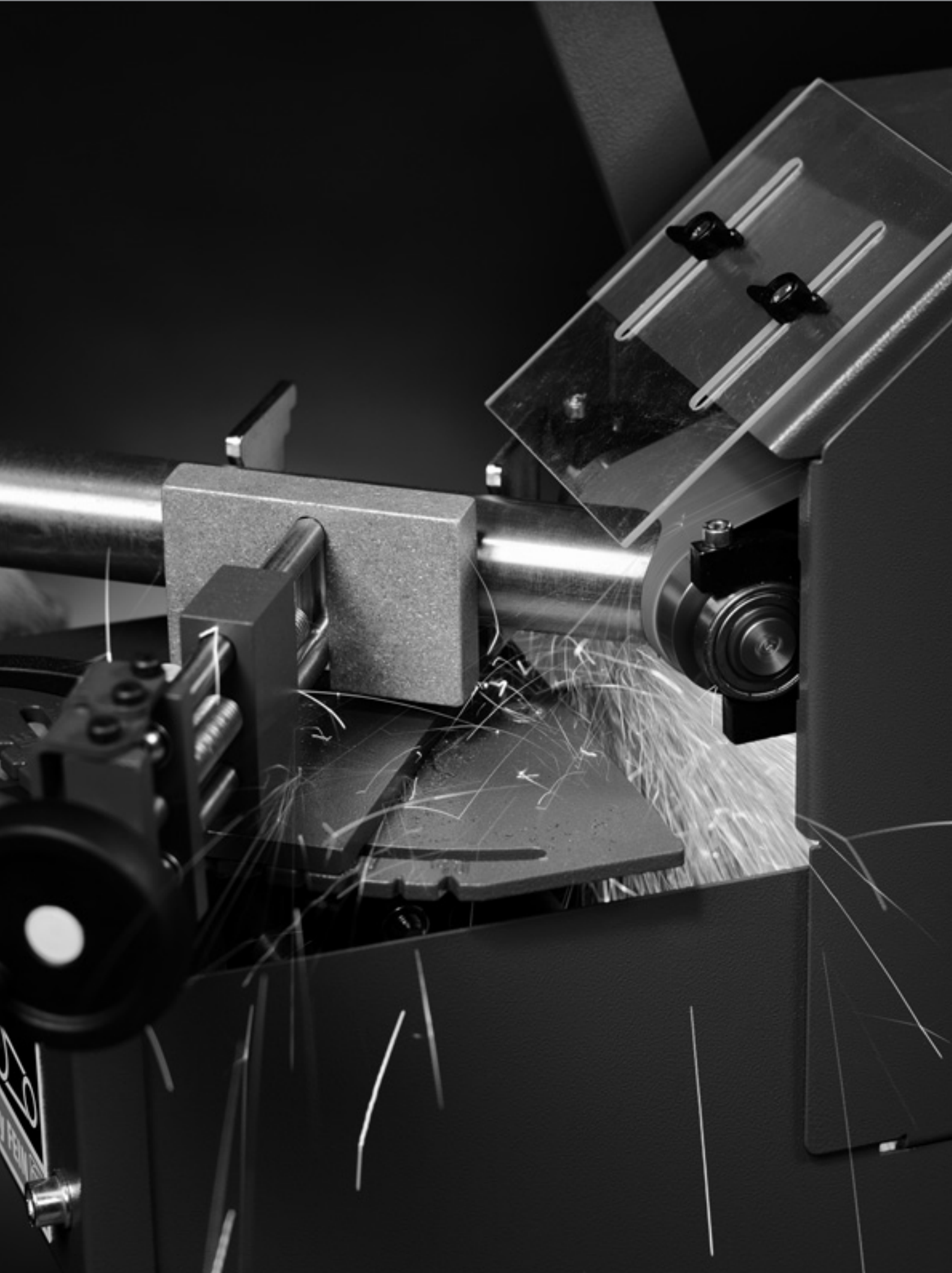

## GRIT – The brand for belt grinding from FEIN

GRIT by FEIN – the name that stands for modular belt grinders that are optimally adapted to metalworking and metal machining applications. A highly economical system for all standards and requirements – for belt grinding, deburring, radial grinding or centreless grinding. This system is suitable for all applications involving steel and stainless steel. Powerful basic belt grinders and specific add-on modules cover all the main belt grinding applications in industry and the manual trades. The high quality standards of GRIT machines also apply to our accessories and grinding belts. We believe that grinding belts should be of premium quality – for maximum sanding capacity and outstanding

service lives in metal machining. This makes genuine GRIT grinding belts very cost-effective to use. You will find more detailed information about the GRIT range in the GRIT product brochure or at [www.fein.com](http://www.fein.com).

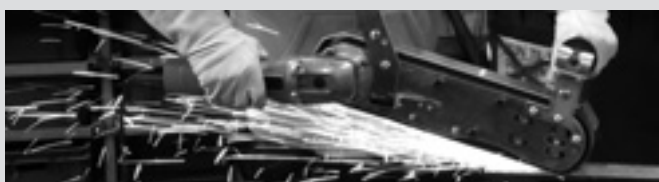

---

**GRIT GHB hand-guided belt grinder** **Page** 248



---

**GRIT GHB add-on modules** **Page** 250



---

**GRIT GX basic belt grinder** **Page** 252

Stationary belt grinders for use in trade and small-scale volume production.



---

**GRIT GI basic belt grinder for industry** **Page** 255

Stationary belt grinders for use in industry and volume production.

---

**GRIT GI add-on modules for industry** **Page** 258



		GRIT GHB 15-50	GRIT GHB 15-50 Inox
		Powerful handheld belt grinder for flexible on-site use.	Universal handheld belt grinder for on-site problem-solving, ideal for stainless steel processing.
<b>Page</b>		249	249
<b>Technical features</b>	Input	1,5 kW	1,5 kW
	Speed, no load	8 500 1/min	2 500 - 7 900 1/min
	Belt size	50 x 1 000 mm	50 x 1 000 mm
	Weight according to EPTA	5,6 kg	5,6 kg

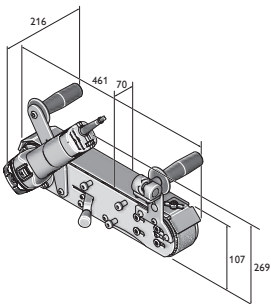

GHB 15-50  
GHB 15-50 Inox

**GRIT GHB 15-50**

Powerful handheld belt grinder for flexible on-site use.



Input	kW	1,5
Speed, no load	1/min	8 500
Belt size	mm	50 x 1 000
Cable with plug	m	4
Weight according to EPTA	kg	5,6
<b>Part number</b>	<b>7 903 01 00 23 2</b>	
<b>EAN</b>	<b>4014586880426</b>	
<b>Price in € [PC01]</b>	<b>642,60</b>	

**FEIN benefits:**

- ▶ Hand-guided alternative for angle grinders.
- ▶ Stationary use possible with table holder.
- ▶ Patented tool-free belt clamping system.
- ▶ Continuously adjustable flange-mounted motor.
- ▶ anti-vibration handle
- ▶ Very short tooling time for stationary belt grinding.
- ▶ Height-adjustable table for flat grinding.

**Price includes:**

1 grinding belt 50 x 1 000 mm (K 36)

For accessories, see page 251

**GRIT GHB 15-50 Inox**

Universal handheld belt grinder for on-site problem-solving, ideal for stainless steel processing.



Input	kW	1,5
Speed, no load	1/min	2 500 - 7 900
Belt size	mm	50 x 1 000
Cable with plug	m	4
Weight according to EPTA	kg	5,6
<b>Part number</b>	<b>7 903 02 00 23 2</b>	
<b>EAN</b>	<b>4014586880457</b>	
<b>Price in € [PC01]</b>	<b>706,65</b>	

**FEIN benefits:**

- ▶ Hand-guided alternative for angle grinders for trades and industry.
- ▶ Stationary use possible with table holder.
- ▶ Patented tool-free belt clamping system.
- ▶ Continuously adjustable flange-mounted motor.
- ▶ anti-vibration handle
- ▶ Very short tooling time for stationary belt grinding.
- ▶ Height-adjustable table for flat grinding.

**Price includes:**

1 grinding belt 50 x 1 000 mm (K 36)

For accessories, see page 251

**GRIT GHBD**

Module for stationary belt grinding.



Dimensions LxWxH	mm	560 x 240 x 230
Belt size	mm	50 x 1 000
<b>Part number</b>		<b>9 90 01 012 00 0</b>
<b>EAN</b>		<b>4014586880488</b>
<b>Price in € [PC01]</b>		<b>214,20</b>

**FEIN benefits:**

- ▶ Transforms hand-guided GHB into a stationary belt grinder.
- ▶ Perfect chamfering thanks to adjustable grinding table.
- ▶ Process profiles & pipes on the grinding table.
- ▶ Designed for heavy-duty use.

**Price includes:**

1 GHBD module

For accessories, see page 251

**GRIT GHBM**

Module for mobile surface processing.



Dimensions LxWxH	mm	430 x 252 x 166
Belt size	mm	50 x 1 000
Weight	kg	5,00
<b>Part number</b>		<b>9 90 01 012 01 0</b>
<b>EAN</b>		<b>4014586886992</b>
<b>Price in € [PC01]</b>		<b>420,00</b>

**FEIN benefits:**

- ▶ Minimal effort required when grinding long welded seams thanks to roller guide.
- ▶ Convert to a different application in under 45 seconds.
- ▶ Homogeneous surfaces in one work step.
- ▶ Low-fatigue machining of large areas.

**Price includes:**

1 GHBM module

For accessories, see page 251

**GRIT GHBR**

Module for stationary pipe notching.



Dimensions LxWxH	mm	700 x 240 x 207
Belt size	mm	50 x 1 150
Weight	kg	13,00
<b>Part number</b>		<b>9 90 01 012 02 0</b>
<b>EAN</b>		<b>4014586887005</b>
<b>Price in € [PC01]</b>		<b>519,75</b>

**FEIN benefits:**

- ▶ Can also be used on site.
- ▶ Easily process pipes with different diameters.
- ▶ Exact radii in one work step.
- ▶ Contact rollers for different pipe diameters.
- ▶ Use only with GHB15-50 Inox.

**Price includes:**

1 GHBR module

For accessories, see page 251



**Grinding belts**



**3M™ Cubitron™ II**  
Precision grinding belt with ceramic grain guarantees maximum performance and service life. The evenly shaped ceramic grains produce a uniquely accurate feel during machining. The result is cool grinding without tarnishing and better surface quality.  
50 x 1 000 mm

Grain	No. in pack	Part number	Price in €
36	10	6 99 03 126 00 0	149,94
60	10	6 99 03 127 00 0	131,73
80	10	6 99 03 128 00 0	115,67



**3M™ Cubitron™ II**  
Precision grinding belt with ceramic grain guarantees maximum performance and service life. The evenly shaped ceramic grains produce a uniquely accurate feel during machining. The result is cool grinding without tarnishing and better surface quality.  
50 x 1 150 mm

Grain	No. in pack	Part number	Price in €
36	10	6 99 03 157 00 0	172,20



**Grinding material Z**  
It's the all-rounder for grinding and deburring steel and non-ferrous metals which also satisfies the most stringent requirements. Developed in collaboration with professional users, this grinding material features an impressively long service life and high performance and is cost-effective to use. Heavy polyester fabric, fully bonded with artificial resins, with zirconium corundum.  
50 x 1 000 mm

Grain	No. in pack	Part number	Price in €
36	10	6 99 03 130 00 0	56,76
60	10	6 99 03 131 00 0	38,56
80	10	6 99 03 132 00 0	35,34
120	10	6 99 03 133 00 0	28,92



**Grinding material Z**  
It's the all-rounder for grinding and deburring steel and non-ferrous metals which also satisfies the most stringent requirements. Developed in collaboration with professional users, this grinding material features an impressively long service life and high performance and is cost-effective to use. Heavy polyester fabric, fully bonded with artificial resins, with zirconium corundum.  
50 x 1 150 mm

Grain	No. in pack	Part number	Price in €
36	10	6 99 03 159 00 0	67,20

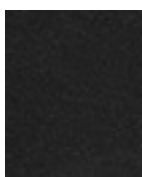

**Grinding material A**  
Grinding belts with fine grit for fine grinding of metals to final finish. For the best surface results. Heavy cotton fabric, fully bonded with artificial resins, with corundum.  
50 x 1 000 mm

Grain	No. in pack	Part number	Price in €
220	10	6 99 03 134 00 0	27,85
320	10	6 99 03 135 00 0	27,85
420	10	6 99 03 136 00 0	27,85

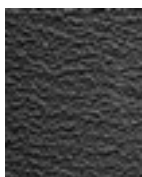

**Grinding material R**  
It's the top grinding belt on the market, featuring superior service life and performance for considerably shorter working times. Especially recommended for machining stainless and high-alloy steel. Extra heavy polyester fabric, fully bonded with artificial resins, with zirconium corundum. Additional top layer for cooling during grinding.  
50 x 1 000 mm

Grain	No. in pack	Part number	Price in €
36	10	6 99 03 137 00 0	62,12
60	10	6 99 03 138 00 0	47,12
80	10	6 99 03 139 00 0	42,84
120	10	6 99 03 140 00 0	41,77



**Grinding material R**  
It's the top grinding belt on the market, featuring superior service life and performance for considerably shorter working times. Especially recommended for machining stainless and high-alloy steel. Extra heavy polyester fabric, fully bonded with artificial resins, with zirconium corundum. Additional top layer for cooling during grinding.  
50 x 1 150 mm

Grain	No. in pack	Part number	Price in €
36	10	6 99 03 158 00 0	71,40

**Fleece strips**

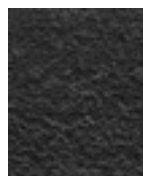

**Fleece belt**  
Reliable for everything from covering up minor mistakes to a perfect finish. Long service lives make for cost-effective working.  
50 x 1 000 mm

Model	No. in pack	Part number	Price in €
very fine	3	6 99 03 144 00 0	49,27
medium	3	6 99 03 143 00 0	52,48
course	3	6 99 03 142 00 0	54,62

**Accessories for GHBR**



**Contact roller**  
Long service lives, low roll resistance thanks to high-quality ball bearings, easy to interchange

Ø mm	Part number	Price in €
16	6 99 02 000 40 9	58,80
18	6 99 02 000 41 0	58,80
19	6 99 02 000 41 1	58,80
20	6 99 02 000 41 2	58,80
21	6 99 02 000 41 3	58,80
21,3	6 99 02 000 41 4	58,80
22	6 99 02 000 41 5	58,80
25	6 99 02 000 41 6	58,80
25,4	6 99 02 000 41 7	58,80
26	6 99 02 000 41 8	58,80
26,9	6 99 02 000 41 9	58,80
27	6 99 02 000 42 0	58,80
28	6 99 02 000 42 1	58,80
28,8	6 99 02 000 42 2	58,80
30	6 99 02 000 42 3	58,80
31,7	6 99 02 000 42 4	58,80
32	6 99 02 000 42 5	58,80
33	6 99 02 000 42 6	58,80
33,7	6 99 02 000 42 7	58,80
34	6 99 02 000 42 8	58,80
35	6 99 02 000 42 9	58,80
38	6 99 02 000 43 0	58,80
38,1	6 99 02 000 43 1	58,80
38,3	6 99 02 000 43 2	58,80
40	6 99 02 000 43 3	58,80
42	6 99 02 000 43 4	58,80
42,4	6 99 02 000 43 5	58,80

**Other accessories for GRIT GHB**

**Stainless steel sanding support**  
GRIT GHB 15-50 Inox

Part number	Price in €
3 90 00 008 10 6	67,47



		<b>GRIT GX 75</b>	<b>GRIT GX 75 2H</b>
		Powerful belt grinder, modular expandable, for manual trades and for small series	Powerful belt grinder, modular expandable, for manual trades and for small series, ideal for machining stainless steel
<b>Page</b>		253	253
<b>Technical features</b>	Input	3 kW	1,5 / 2 kW
	Speed, no load	3 000 1/min	1 500 / 3 000 1/min
	Belt size	75 x 2 000 mm	75 x 2 000 mm
	Weight	75 kg	75 kg



**GRIT GX 75**

Powerful belt grinder, modular expandable, for manual trades and for small series



Input	kW	3
Speed, no load	1/min	3 000
Belt size	mm	75 x 2 000
Weight	kg	75
<b>Part number</b>		<b>7 901 31 00 40 3</b>
<b>EAN</b>		<b>4014586872018</b>
<b>Price in € [PC13]</b>		<b>957,60</b>

**FEIN benefits:**

- ▶ Expandable because of additional modules
- ▶ Speeds optimal for metal working at 3 000 rpm;
- ▶ Height-adjustable plane grinding table for linear plane grinding
- ▶ Detachable swarf collector
- ▶ Connection for extraction option available
- ▶ Work level is individually adjustable
- ▶ Patented belt-tensioning system
- ▶ Robust three-phase AC motor
- ▶ Low vibrations

**Price includes:**

1 CEE plug (16 A), 1 grinding belt 75 x 2 000 mm (K 36 R)

For accessories, see page 262

**GRIT GX 75 2H**

Powerful belt grinder, modular expandable, for manual trades and for small series, ideal for machining stainless steel



Input	kW	1,5 / 2
Speed, no load	1/min	1 500 / 3 000
Belt size	mm	75 x 2 000
Weight	kg	75
<b>Part number</b>		<b>7 901 32 00 40 3</b>
<b>EAN</b>		<b>4014586872063</b>
<b>Price in € [PC13]</b>		<b>1.143,45</b>

**FEIN benefits:**

- ▶ Expandable because of additional modules
- ▶ Speeds optimal for metal and stainless steel working at 1 500/3 000 rpm;
- ▶ Height-adjustable plane grinding table for linear plane grinding
- ▶ Detachable swarf collector
- ▶ Connection for extraction option available
- ▶ Work level is individually adjustable
- ▶ Patented belt-tensioning system
- ▶ Robust three-phase AC motor
- ▶ Low vibrations

**Price includes:**

1 grinding belt 75 x 2 000 mm (K 36 R), 1 CEE plug (16 A)

For accessories, see page 262

**GRIT GXE**

Highly effective deburring machine for manual trades and for small series



Input	kW	2,2
Speed, no load	1/min	1 500
Tool dimensions max. Ø x width	mm	250 x 60
Weight	kg	32
<b>Part number</b>		<b>7 901 05 00 40 3</b>
<b>EAN</b>		<b>4014586857879</b>
<b>Price in € [PC13]</b>		<b>767,55</b>

**FEIN benefits:**

- ▶ Modular extendable with sturdy machine base also with integrated extraction
- ▶ Robust AC motor provides deburring with steady speed
- ▶ For deburring of metal pipes, profiles, and flat materials up to a workpiece width of 75 mm.
- ▶ Connection for extraction option available
- ▶ Broad range of wire brushes available
- ▶ Effective deburring
- ▶ Motor protection switch

**Price includes:**

1 CEE plug (16 A)

For accessories, see page 262

**GRIT GXC**

Cylindrical grinding module for perfect surfaces of metal and stainless steel pipes and shafts



Input	kW	0,18
Pipes up to Ø	mm	10 - 100
Belt size	mm	75 x 2 000
Weight	kg	48
<b>Part number</b>		<b>7 901 23 00 44 3</b>
<b>EAN</b>		<b>4014586871936</b>
<b>Price in € [PC13]</b>		<b>1.096,20</b>

**FEIN benefits:**

- ▶ Automatic feed is individually adjustable
- ▶ High process speed at highest surface quality
- ▶ For grinding of pipes and shafts of diameters ranging from Ø 10 - 100 mm
- ▶ Combination possibilities with belt grinders GX 75 (2H) and GI 75 (2H)
- ▶ Wet grinding in possible combination with GXW

**Price includes:**

1 guide rail, nylon, 1 guide rail, brass, 1 CEE plug (16 A)

For accessories, see page 262

**GRIT GXW**

Cooling lubricant module for a professional wet grinding



Input	kW	0,12
Weight	kg	8,6
<b>Part number</b>		<b>7 901 24 00 44 3</b>
<b>EAN</b>		<b>4014586873145</b>
<b>Price in € [PC13]</b>		<b>603,75</b>

**FEIN benefits:**

- ▶ Perfect surface results due to effective cooling lubricant supply
- ▶ Binds the swarf
- ▶ Closed circuit
- ▶ Combination possibilities with belt grinders GX 75 (2H) and GI 75 (2H)
- ▶ Increases service life of the grinding belts

**Price includes:**

1 litre cooling lubricant emulsion (1:30)

For accessories, see page 262

**GRIT GXR**

Radii-grinding module for precision fitting of pipes, profiles, and flat materials



Pipes up to Ø	mm	16 - 75
Belt size	mm	75 x 2 250
Dimension profiles / flat material max.	mm	75 x 75
Weight	kg	54
<b>Part number</b>		<b>9 90 01 001 00 1</b>
<b>EAN</b>		<b>4014586871974</b>
<b>Price in € [PC13]</b>		<b>1.081,50</b>

**FEIN benefits:**

- ▶ For precise grinding of profiles and pipes of diameters ranging from 16 to 75 mm
- ▶ Contact rollers are optionally available in standard dimensions
- ▶ Optional length stop for series application
- ▶ Integrated depth stop
- ▶ Combination possibilities with belt grinders GX 75 (2H) and GI 75 (2H)
- ▶ Angle setting, individually possible up to 90°

**Price includes:**

1 contact roller Ø 42.4 mm, 1 contact roller Ø 48,3 mm, 1 grinding belt 75 x 2 250 (K 36 R).

For accessories, see page 262



	GRIT GI 75	GRIT GI 75 2H	GRIT GI 100 EF	GRIT GI 100	GRIT GI 150	GRIT GI 150 2H	GRIT GIS 75	GRIT GIS 150	
	High-performance belt grinder, modular expandable, for industrial and series applications	High-performance belt grinder, modular expandable, for industrial and series applications, ideal for machining stainless steel	Powerful belt grinder in small format: for universal application on small workpieces		High-performance belt grinder, modular expandable, for industrial and series applications	High-performance belt grinder, modular expandable, for industrial and series applications, ideal for machining stainless steel	High-performance grinder for standard grinding tasks	High-performance grinder for standard grinding applications for extra-wide workpieces.	
<b>Page</b>	256	256	257	257	256	256	257	257	
<b>Technical features</b>	Input	4 kW	2,6 - 3,1 kW	1,5 kW	1,5 kW	4 kW	2,6 - 3,1 kW	4 kW	4 kW
	Speed, no load	3 000 1/min	1 500 / 3 000 1/min	3 000 1/min	3 000 1/min	3 000 1/min	1 500 / 3 000 1/min	3 000 1/min	3 000 1/min
	Belt size	75 x 2 000 mm	75 x 2 000 mm	100 x 1 000 mm	100 x 1 000 mm	150 x 2 000 mm	150 x 2 000 mm	75 x 2 000 mm	150 x 2 000 mm
	Weight	65 kg	65 kg	29,8 kg	28,8 kg	82 kg	82 kg	74 kg	93 kg

**GRIT GI 75**

High-performance belt grinder, modular expandable, for industrial and series applications



For accessories, see page 262

Input	kW	4
Speed, no load	1/min	3 000
Belt size	mm	75 x 2 000
Weight	kg	65
<b>Part number</b>	<b>7 902 01 00 40 3</b>	
<b>EAN</b>	<b>4014586858913</b>	
<b>Price in € [PC13]</b>	<b>1.492,05</b>	

**FEIN benefits:**

- ▶ Expandable because of additional modules
- ▶ Quite robust AC motor provides grinding with steady speed.
- ▶ Speeds optimal for metal working at 3 000 rpm;
- ▶ Detachable swarf collector
- ▶ Connection for extraction option available
- ▶ Drive disk with polyurethane coating
- ▶ Work level is individually adjustable
- ▶ Patented belt-tensioning system
- ▶ Robust three-phase AC motor
- ▶ Low vibrations

**Price includes:**

1 CEE plug (16 A), 1 grinding belt 75 x 2 000 mm (K 36 R)

**GRIT GI 75 2H**

High-performance belt grinder, modular expandable, for industrial and series applications, ideal for machining stainless steel



For accessories, see page 262

Input	kW	2,6 - 3,1
Speed, no load	1/min	1 500 / 3 000
Belt size	mm	75 x 2 000
Weight	kg	65
<b>Part number</b>	<b>7 902 02 00 40 3</b>	
<b>EAN</b>	<b>4014586858944</b>	
<b>Price in € [PC13]</b>	<b>1.789,20</b>	

**FEIN benefits:**

- ▶ Expandable because of additional modules
- ▶ Quite robust AC motor provides grinding with steady speed.
- ▶ Speeds optimal for metal and stainless steel working at 1 500/3 000 rpm;
- ▶ Detachable swarf collector
- ▶ Connection for extraction option available
- ▶ Drive disk with polyurethane coating
- ▶ Work level is individually adjustable
- ▶ Exceedingly robust three-phase AC motor
- ▶ Patented belt-tensioning system
- ▶ Low vibrations

**Price includes:**

1 CEE plug (16 A), 1 grinding belt 75 x 2 000 mm (K 36 R)

**GRIT GI 150**

High-performance belt grinder, modular expandable, for industrial and series applications



For accessories, see page 262

Input	kW	4
Speed, no load	1/min	3 000
Belt size	mm	150 x 2 000
Weight	kg	82
<b>Part number</b>	<b>7 902 04 00 40 3</b>	
<b>EAN</b>	<b>4014586858999</b>	
<b>Price in € [PC13]</b>	<b>1.802,85</b>	

**FEIN benefits:**

- ▶ Expandable because of additional modules
- ▶ Quite robust AC motor provides grinding with steady speed.
- ▶ Speeds optimal for metal working at 3 000 rpm;
- ▶ Detachable swarf collector
- ▶ Connection for extraction option available
- ▶ Drive disk with polyurethane coating
- ▶ Work level is individually adjustable
- ▶ Patented belt-tensioning system
- ▶ Robust three-phase AC motor
- ▶ Low vibrations

**Price includes:**

1 CEE plug (16 A), 1 grinding belt 150 x 2 000 mm (K 36 R)

**GRIT GI 150 2H**

High-performance belt grinder, modular expandable, for industrial and series applications, ideal for machining stainless steel



For accessories, see page 262

Input	kW	2,6 - 3,1
Speed, no load	1/min	1 500 / 3 000
Belt size	mm	150 x 2 000
Weight	kg	82
<b>Part number</b>	<b>7 902 05 00 40 3</b>	
<b>EAN</b>	<b>4014586859019</b>	
<b>Price in € [PC13]</b>	<b>2.103,15</b>	

**FEIN benefits:**

- ▶ Expandable because of additional modules
- ▶ Quite robust AC motor provides grinding with steady speed.
- ▶ Speeds optimal for metal and stainless steel working at 1 500/3 000 rpm;
- ▶ Detachable swarf collector
- ▶ Connection for extraction option available
- ▶ Drive disk with polyurethane coating
- ▶ Work level is individually adjustable
- ▶ Exceedingly robust three-phase AC motor
- ▶ Patented belt-tensioning system
- ▶ Low vibrations

**Price includes:**

1 CEE plug (16 A), 1 grinding belt 150 x 2 000 mm (K 36 R)

**GRIT GIS 75**

High-performance grinder for standard grinding tasks



Input	kW	4
Current/Voltages		3 x 400/440V 50/60Hz
Idle speed at 50 Hz	1/min	3 000
Idle speed at 60 Hz	1/min	3 450
Belt size	mm	75 x 2 000
Weight	kg	74
<b>Part number</b>		<b>7 902 29 50 44 3</b>
<b>EAN</b>		<b>4014586878126</b>
<b>Price in € [PC13]</b>		<b>1.328,25</b>

**FEIN benefits:**

- ▶ High-performance belt grinder with sturdy machine base
- ▶ Constant speed at high grinding performance thanks to robust 4-kW motor
- ▶ Very good price-performance ratio
- ▶ Detachable swarf collector
- ▶ Patented belt-tensioning system
- ▶ Low-vibration thanks to robust design

**Price includes:**

1 CEE plug (16 A), 1 grinding belt 75 x 2 000 mm (K 36 R)

For accessories, see page 262

**GRIT GIS 150**

High-performance grinder for standard grinding applications for extra-wide workpieces.



Input	kW	4
Current/Voltages		3 x 400/440V 50/60Hz
Idle speed at 50 Hz	1/min	3 000
Idle speed at 60 Hz	1/min	3 450
Belt size	mm	150 x 2 000
Weight	kg	93
<b>Part number</b>		<b>7 902 30 50 44 3</b>
<b>EAN</b>		<b>4014586878225</b>
<b>Price in € [PC13]</b>		<b>1.598,10</b>

**FEIN benefits:**

- ▶ High-performance belt grinder with sturdy machine base
- ▶ Constant speed at high grinding performance thanks to robust 4-kW motor
- ▶ Very good price-performance ratio
- ▶ Detachable swarf collector
- ▶ Patented belt-tensioning system
- ▶ Low-vibration thanks to robust design

**Price includes:**

1 CEE plug (16 A), 1 grinding belt 150 x 2 000 mm (K 36 R)

For accessories, see page 262

**GRIT GI 100 EF**

Powerful belt grinder in small format: for universal application on small workpieces



Input	kW	1,5
Current/Voltages		1 x 230 V
Speed, no load	1/min	3 000
Belt size	mm	100 x 1 000
Weight	kg	29,8
<b>Part number</b>		<b>7 902 23 00 23 2</b>
<b>EAN</b>		<b>4014586887043</b>
<b>Price in € [PC13]</b>		<b>1.079,40</b>

**FEIN benefits:**

- ▶ Modular extendable with sturdy machine base also with integrated extraction
- ▶ Universally applicable belt grinder for smaller workpieces
- ▶ Can be used as a table machine
- ▶ Single-phase, alternating current version 230V / 50Hz
- ▶ Suited also for mobile employment in workshop or assembly vehicles
- ▶ Patented belt-tensioning system

**Price includes:**

1 grinding belt 100 x 1 000 (K 60 Z)

For accessories, see page 262

**GRIT GI 100**

Powerful belt grinder in small format: for universal application on small workpieces



Input	kW	1,5
Current/Voltages		3 x 400/440V 50/60Hz
Idle speed at 50 Hz	1/min	3 000
Idle speed at 60 Hz	1/min	3 450
Belt size	mm	100 x 1 000
Weight	kg	28,8
<b>Part number</b>		<b>7 902 23 00 40 3</b>
<b>EAN</b>		<b>4014586887067</b>
<b>Price in € [PC13]</b>		<b>915,60</b>

**FEIN benefits:**

- ▶ Can be used as a table machine
- ▶ Modular extendable with sturdy machine base also with integrated extraction
- ▶ Universally applicable belt grinder for smaller workpieces
- ▶ Three-phase AC motor 1 500 Watt
- ▶ Suited also for mobile employment in workshop or assembly vehicles
- ▶ Patented belt-tensioning system

**Price includes:**

1 grinding belt 100 x 1 000 (K 60 Z)

For accessories, see page 262

**GRIT GIE**

Highly effective deburring machine for industrial deburring in series



For accessories, see page 262

Input	kW	1,5 / 2
Speed, no load	1/min	1 500 / 3 000
Tool dimensions max. Ø x width	mm	250 x 60/120
Weight	kg	34
<b>Part number</b>		<b>7 902 07 00 40 3</b>
<b>EAN</b>		<b>4014586859057</b>
<b>Price in € [PC13]</b>		<b>1.422,75</b>

**FEIN benefits:**

- ▶ Speeds optimal for metal and stainless steel working at 1 500/3 000 rpm;
- ▶ Modular extendable with sturdy machine base also with integrated extraction
- ▶ Robust AC motor provides deburring with steady speed
- ▶ Connection for extraction option available
- ▶ Broad range of wire brushes available
- ▶ Effective deburring
- ▶ Motor protection switch

**Price includes:**

1 CEE plug (16 A)

**GRIT GIC**

Centreless grinding module for industrial centreless grinding in volume production



For accessories, see page 262

Input	kW	0,18
Pipes up to Ø	mm	10 - 130
Belt size	mm	75/150 x 2 000
Variable Feed	m/min	0 - 2
Weight	kg	65
<b>Part number</b>		<b>7 902 12 00 44 3</b>
<b>EAN</b>		<b>4014586867656</b>
<b>Price in € [PC13]</b>		<b>2.427,60</b>

**FEIN benefits:**

- ▶ For industrial centreless grinding of pipes up to 6 m long with optional pipe guide.
- ▶ Flexible when machining pipe diameters of between 10 and 130 mm.
- ▶ Cool surfaces and a long grinding belt service life thanks to wet grinding in conjunction with the cooling lubricant module GXW.
- ▶ Combination possibilities with belt grinder GI 75 (2H) and GI 150 (2H).
- ▶ Quick fastener for simple retooling without the need for tools.
- ▶ Infinitely variable feed speed from 0 to 2 m/min.

**Price includes:**

1 guide rail, nylon, 1 guide rail, brass, 1 CEE plug (16 A)

**GRIT GIMS 75**

Mobile carriage for effective grinding "on site" at the floor



For accessories, see page 262

Input	kW	4
Belt size	mm	75 x 2 000
Weight	kg	100
<b>Part number</b>		<b>7 902 13 00 40 3</b>
<b>EAN</b>		<b>4014586872599</b>
<b>Price in € [PC13]</b>		<b>2.870,70</b>

**FEIN benefits:**

- ▶ Comfortable work handling thanks to standing work position
- ▶ Highly effective grinding and polishing of weld seams on the floor
- ▶ Grinding over and descaling of steel parts
- ▶ Towing bar position can be adjusted infinitely variable
- ▶ Minimum wall clearance
- ▶ Depth stop

**GRIT GIMS 150**

Mobile carriage for effective grinding "on site" at the floor



For accessories, see page 262

Input	kW	4
Belt size	mm	150 x 2 000
Weight	kg	110
<b>Part number</b>		<b>7 902 14 00 40 3</b>
<b>EAN</b>		<b>4014586872643</b>
<b>Price in € [PC13]</b>		<b>3.099,60</b>

**FEIN benefits:**

- ▶ Comfortable work handling thanks to standing work position
- ▶ Highly effective grinding and polishing of weld seams on the floor
- ▶ Grinding over and descaling of steel parts
- ▶ Towing bar position can be adjusted infinitely variable
- ▶ Minimum wall clearance
- ▶ Depth stop

**GIMS 75 2H**

Mobile carriage for effective grinding "on site" at the floor



Input	kW	2,6 - 3,1
Belt size	mm	75 x 2 000
Weight	kg	103
<b>Part number</b>		<b>7 902 16 00 40 3</b>
<b>EAN</b>		<b>4014586878614</b>
<b>Price in € [PC13]</b>		<b>3.342,15</b>

**FEIN benefits:**

- ▶ Comfortable work handling thanks to standing work position
- ▶ Highly effective grinding and polishing of weld seams on the floor
- ▶ Grinding over and descaling of steel parts
- ▶ Towing bar position can be adjusted infinitely variable
- ▶ Minimum wall clearance
- ▶ Depth stop

For accessories, see page 262

**GIMS 150 2H**

Mobile carriage for effective grinding "on site" at the floor



Input	kW	2,6 - 3,1
Belt size	mm	150 x 2 000
Weight	kg	114
<b>Part number</b>		<b>7 902 17 00 40 3</b>
<b>EAN</b>		<b>4014586878621</b>
<b>Price in € [PC13]</b>		<b>3.565,80</b>

**FEIN benefits:**

- ▶ Comfortable work handling thanks to standing work position
- ▶ Highly effective grinding and polishing of weld seams on the floor
- ▶ Grinding over and descaling of steel parts
- ▶ Towing bar position can be adjusted infinitely variable
- ▶ Minimum wall clearance
- ▶ Depth stop

For accessories, see page 262

**GIMS 75-6**

Mobile carriage for effective grinding "on site" at the floor



Input	kW	6
Belt size	mm	75 x 2 000
Weight	kg	121
<b>Part number</b>		<b>7 902 18 00 40 3</b>
<b>EAN</b>		<b>4014586878645</b>
<b>Price in € [PC13]</b>		<b>3.342,15</b>

**FEIN benefits:**

- ▶ Highly effective grinding and polishing of weld seams on the floor
- ▶ Comfortable work handling thanks to standing work position
- ▶ Grinding over and descaling of steel parts
- ▶ Minimum wall clearance
- ▶ Towing bar position can be adjusted infinitely variable
- ▶ Depth stop

For accessories, see page 262

**GIMS 150-6**

Mobile carriage for effective grinding "on site" at the floor



Input	kW	6
Belt size	mm	150 x 2 000
Weight	kg	131
<b>Part number</b>		<b>7 902 19 00 40 3</b>
<b>EAN</b>		<b>4014586878683</b>
<b>Price in € [PC13]</b>		<b>3.565,80</b>

**FEIN benefits:**

- ▶ Grinding over and descaling of steel parts
- ▶ Comfortable work handling thanks to standing work position
- ▶ Highly effective grinding and polishing of weld seams on the floor
- ▶ Depth stop
- ▶ Minimum wall clearance
- ▶ Towing bar position can be adjusted infinitely variable

For accessories, see page 262

**GRIT GILSGIB**

Surface grinder for perfect longitudinal grinding of square pipes, profiles and flat materials in automatic processes



Input	kW	2,6 - 3,1
Belt size	mm	150 x 2 000
Dimension profiles / flat material max.	mm	100 x 100
Weight	kg	189
<b>Part number</b>		<b>7 902 35 00 40 3</b>
<b>EAN</b>		<b>4014586880921</b>
<b>Price in € [PC13]</b>		<b>5.040,00</b>

without dust extraction

**FEIN benefits:**

- ▶ High operating speed because of automatic feed
- ▶ Perfect finishing results up to the finish
- ▶ Flat material can also be ground "upright".
- ▶ Consistent belt dimensions 150 x 2 000 mm
- ▶ Belt grinder can be used for contact grinding even though module is mounted.
- ▶ For angled workpieces
- ▶ Combination possibility with belt grinder GI 150 (2H)
- ▶ Space-saving employment because of optional swivel plate possible.

**Price includes:**

1 CEE plug (16 A), 1 grinding belt 150 x 2 000 mm (K 120 R)

For accessories, see page 262



**GRIT GIL**

Plane grinding module for perfect longitudinal grinding of square pipes, profiles and flat materials



For accessories, see page 262

Input	kW	0,18
Belt size	mm	150 x 2 000
Dimension profiles / flat material max.	mm	100 x 100
Weight	kg	64
<b>Part number</b>		<b>7 902 48 00 40 3</b>
<b>EAN</b>		<b>4014586880945</b>
<b>Price in € [PC13]</b>		<b>2.427,60</b>

**FEIN benefits:**

- ▶ High operating speed because of automatic feed
- ▶ Perfect finishing results up to the finish
- ▶ Flat material can also be ground "upright".
- ▶ Consistent belt dimensions 150 x 2 000 mm
- ▶ Belt grinder can be used for contact grinding even though module is mounted.
- ▶ For angled workpieces
- ▶ Combination possibility with belt grinder GI 150 (2H)
- ▶ Space-saving employment because of optional swivel plate possible.

**GRIT GILS**

Surface grinder for perfect longitudinal grinding of square pipes, profiles and flat materials in automatic processes



For accessories, see page 262

Input	kW	2,6 - 3,1
Belt size	mm	150 x 2 000
Dimension profiles / flat material max.	mm	100 x 100
Weight	kg	206
<b>Part number</b>		<b>7 902 51 00 40 3</b>
<b>EAN</b>		<b>4014586880976</b>
<b>Price in € [PC13]</b>		<b>6.245,40</b>

with dust extraction

**FEIN benefits:**

- ▶ High operating speed because of automatic feed
- ▶ Perfect finishing results up to the finish
- ▶ Flat material can also be ground "upright".
- ▶ Consistent belt dimensions 150 x 2 000 mm
- ▶ Belt grinder can be used for contact grinding even though module is mounted.
- ▶ For angled workpieces
- ▶ Combination possibility with belt grinder GI 150 (2H)
- ▶ Space-saving employment because of optional swivel plate possible.

**Price includes:**

1 grinding belt 150 x 2 000 mm (K 120 R), 1 CEE plug (16 A)

**GRIT GIB**

Exceedingly sturdy machine base



For accessories, see page 262

Weight	kg	17
<b>Part number</b>		<b>9 90 01 003 00 0</b>
<b>EAN</b>		<b>4014586859064</b>
<b>Price in € [PC13]</b>		<b>250,95</b>

**FEIN benefits:**

- ▶ Work height can be adjusted conveniently by gas compression spring without effort
- ▶ Low-vibration thanks to robust design
- ▶ Combination possibilities with belt grinder GI 75 (2H) and GI 150 (2H)
- ▶ Powder coating
- ▶ Robust welded construction

**GRIT GIBE**

Exceedingly sturdy machine base with integrated double extraction



For accessories, see page 262

Input	kW	0,35
Weight	kg	55
<b>Part number</b>		<b>9 90 01 004 00 0</b>
<b>EAN</b>		<b>4014586859071</b>
<b>Price in € [PC13]</b>		<b>1.429,05</b>

**FEIN benefits:**

- ▶ Integrated metal swarf collector, resistant against hot sparks
- ▶ Powder coating
- ▶ Robust welded construction
- ▶ Flexible, heat-resistant steel hoses
- ▶ Cassette filter for effective filtering
- ▶ Combination possibilities with belt grinder GI 75 (2H) and GI 150 (2H)

**GRIT GIR**

Radii-grinding module for precision fitting of pipes, profiles and flat materials in series application



Pipes up to Ø	mm	20 - 150
Belt size	mm	150 x 2 250
Dimension profiles / flat material max.	mm	120 x 150
Weight	kg	109
<b>Part number</b>		<b>9 90 01 007 00 1</b>
<b>EAN</b>		<b>4014586878263</b>
<b>Price in € [PC13]</b>		<b>2.064,30</b>

**FEIN benefits:**

- ▶ For precise grinding of profiles and pipes of diameters ranging from 20 to 150 mm
- ▶ Contact rollers are optionally available in standard dimensions
- ▶ Optional length stop for series application
- ▶ Integrated depth stop for the series application
- ▶ Combination possibility with belt grinder GI 150 (2H)
- ▶ Angle setting, individually possible up to 90°

For accessories, see page 262

**GRIT GIXBE**

Integrated motor for effective suction



Max. vacuum	hPa	2,65
Dimensions LxWxH	mm	305 x 575 x 700
Weight	kg	58
<b>Part number</b>		<b>9 90 01 009 00 0</b>
<b>EAN</b>		<b>4014586859125</b>
<b>Price in € [PC13]</b>		<b>1.508,85</b>

**FEIN benefits:**

- ▶ Great steadiness because of bolting to the floor
- ▶ Combination possibility with belt grinder GI 100 (EF) and deburring machines GXE, GIE
- ▶ Powder coating

For accessories, see page 262

**GRIT GIXS**

Sturdy machine base made of powder coated steel plate



Dimensions LxWxH	mm	304 x 356 x 769
Weight	kg	18
<b>Part number</b>		<b>9 90 01 002 00 0</b>
<b>EAN</b>		<b>4014586858340</b>
<b>Price in € [PC13]</b>		<b>227,85</b>

**FEIN benefits:**

- ▶ Great steadiness because of bolting to the floor
- ▶ Combination possibility with belt grinder GI 100 (EF) and deburring machines GXE, GIE
- ▶ Powder coating
- ▶ Steel plate model

For accessories, see page 262

**Grinding belts**



**3M™ Cubitron™ II**

Precision grinding belt with ceramic grain guarantees maximum performance and service life. The evenly shaped ceramic grains produce a uniquely accurate feel during machining. The result is cool grinding without tarnishing and better surface quality.  
75 x 2 000 mm

Grain	No. in pack pcs	Part number	Price in €
36	10	6 99 03 145 00 0	236,25
60	10	6 99 03 146 00 0	200,55
80	10	6 99 03 147 00 0	189,00



**3M™ Cubitron™ II**

Precision grinding belt with ceramic grain guarantees maximum performance and service life. The evenly shaped ceramic grains produce a uniquely accurate feel during machining. The result is cool grinding without tarnishing and better surface quality.  
75 x 2 250 mm

Grain	No. in pack pcs	Part number	Price in €
36	10	6 99 03 151 00 0	271,95
60	10	6 99 03 152 00 0	232,05
80	10	6 99 03 153 00 0	220,50



**3M™ Cubitron™ II**

Precision grinding belt with ceramic grain guarantees maximum performance and service life. The evenly shaped ceramic grains produce a uniquely accurate feel during machining. The result is cool grinding without tarnishing and better surface quality.  
150 x 2 000 mm

Grain	No. in pack pcs	Part number	Price in €
36	10	6 99 03 148 00 0	435,75
60	10	6 99 03 149 00 0	363,30
80	10	6 99 03 150 00 0	341,25



**3M™ Cubitron™ II**

Precision grinding belt with ceramic grain guarantees maximum performance and service life. The evenly shaped ceramic grains produce a uniquely accurate feel during machining. The result is cool grinding without tarnishing and better surface quality.  
150 x 2 250 mm

Grain	No. in pack pcs	Part number	Price in €
36	10	6 99 03 154 00 0	502,95
60	10	6 99 03 155 00 0	421,05
80	10	6 99 03 156 00 0	395,85

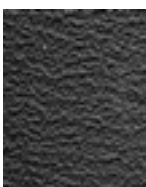

**Grinding material R**

It's the top grinding belt on the market, featuring superior service life and performance for considerably shorter working times. Especially recommended for machining stainless and high-alloy steel. Extra heavy polyester fabric, fully bonded with artificial resins, with zirconium corundum. Additional top layer for cooling during grinding.  
75 x 2 000 mm

Grain	No. in pack pcs	Part number	Price in €
24	10	6 99 03 000 00 0	129,99
36	10	6 99 03 002 00 0	103,88
40	10	6 99 03 004 00 0	98,65
60	10	6 99 03 007 00 0	87,28
80	10	6 99 03 009 00 0	82,01
120	10	6 99 03 013 00 0	77,93

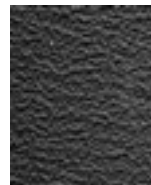

**Grinding material R**

It's the top grinding belt on the market, featuring superior service life and performance for considerably shorter working times. Especially recommended for machining stainless and high-alloy steel. Extra heavy polyester fabric, fully bonded with artificial resins, with zirconium corundum. Additional top layer for cooling during grinding.  
75 x 2 250 mm

Grain	No. in pack pcs	Part number	Price in €
36	10	6 99 03 020 00 0	116,31

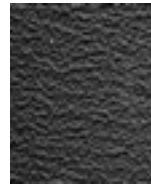

**Grinding material R**

It's the top grinding belt on the market, featuring superior service life and performance for considerably shorter working times. Especially recommended for machining stainless and high-alloy steel. Extra heavy polyester fabric, fully bonded with artificial resins, with zirconium corundum. Additional top layer for cooling during grinding.  
75 x 2 300 mm

Grain	No. in pack pcs	Part number	Price in €
36	10	6 99 03 122 00 0	121,25

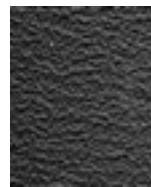

**Grinding material R**

It's the top grinding belt on the market, featuring superior service life and performance for considerably shorter working times. Especially recommended for machining stainless and high-alloy steel. Extra heavy polyester fabric, fully bonded with artificial resins, with zirconium corundum. Additional top layer for cooling during grinding.  
150 x 2 000 mm

Grain	No. in pack pcs	Part number	Price in €
24	10	6 99 03 039 00 0	218,01
36	10	6 99 03 040 00 0	188,07
40	10	6 99 03 042 00 0	178,62
60	10	6 99 03 044 00 0	157,88
80	10	6 99 03 046 00 0	148,53
120	10	6 99 03 048 00 0	140,99

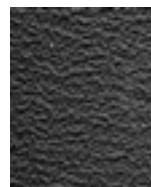

**Grinding material R**

It's the top grinding belt on the market, featuring superior service life and performance for considerably shorter working times. Especially recommended for machining stainless and high-alloy steel. Extra heavy polyester fabric, fully bonded with artificial resins, with zirconium corundum. Additional top layer for cooling during grinding.  
150 x 2 250 mm

Grain	No. in pack pcs	Part number	Price in €
36	10	6 99 03 053 00 0	225,56

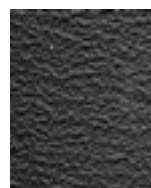

**Grinding material R**

It's the top grinding belt on the market, featuring superior service life and performance for considerably shorter working times. Especially recommended for machining stainless and high-alloy steel. Extra heavy polyester fabric, fully bonded with artificial resins, with zirconium corundum. Additional top layer for cooling during grinding.  
150 x 2 400 mm

Grain	No. in pack pcs	Part number	Price in €
36	10	6 99 03 111 00 0	240,66



**Grinding material Z**

It's the all-rounder for grinding and deburring steel and non-ferrous metals which also satisfies the most stringent requirements. Developed in collaboration with professional users, this grinding material features an impressively long service life and high performance and is cost-effective to use. Heavy polyester fabric, fully bonded with artificial resins, with zirconium corundum.  
75 x 2 000 mm

Grain	No. in pack pcs	Part number	Price in €
36	10	6 99 03 003 00 0	78,81
40	10	6 99 03 005 00 0	74,85
60	10	6 99 03 008 00 0	66,27
80	10	6 99 03 010 00 0	62,30
120	10	6 99 03 014 00 0	59,12



**Grinding material Z**

It's the all-rounder for grinding and deburring steel and non-ferrous metals which also satisfies the most stringent requirements. Developed in collaboration with professional users, this grinding material features an impressively long service life and high performance and is cost-effective to use. Heavy polyester fabric, fully bonded with artificial resins, with zirconium corundum.  
75 x 2 250 mm

Grain	No. in pack pcs	Part number	Price in €
36	10	6 99 03 021 00 0	88,27



**Grinding material Z**

It's the all-rounder for grinding and deburring steel and non-ferrous metals which also satisfies the most stringent requirements. Developed in collaboration with professional users, this grinding material features an impressively long service life and high performance and is cost-effective to use. Heavy polyester fabric, fully bonded with artificial resins, with zirconium corundum.  
100 x 1 000 mm

Grain	No. in pack pcs	Part number	Price in €
36	10	6 99 03 034 00 0	55,27
40	10	6 99 03 035 00 0	52,57
60	10	6 99 03 036 00 0	46,45
80	10	6 99 03 037 00 0	43,75
120	10	6 99 03 038 00 0	41,59



**Grinding material Z**

It's the all-rounder for grinding and deburring steel and non-ferrous metals which also satisfies the most stringent requirements. Developed in collaboration with professional users, this grinding material features an impressively long service life and high performance and is cost-effective to use. Heavy polyester fabric, fully bonded with artificial resins, with zirconium corundum.  
150 x 2 000 mm

Grain	No. in pack pcs	Part number	Price in €
36	10	6 99 03 041 00 0	146,87
40	10	6 99 03 043 00 0	139,61
60	10	6 99 03 045 00 0	123,60
80	10	6 99 03 047 00 0	116,17
120	10	6 99 03 049 00 0	110,16



**Grinding material Z**

It's the all-rounder for grinding and deburring steel and non-ferrous metals which also satisfies the most stringent requirements. Developed in collaboration with professional users, this grinding material features an impressively long service life and high performance and is cost-effective to use. Heavy polyester fabric, fully bonded with artificial resins, with zirconium corundum.  
150 x 2 250 mm

Grain	No. in pack pcs	Part number	Price in €
36	10	6 99 03 054 00 0	176,42



**Grinding material Z**

It's the all-rounder for grinding and deburring steel and non-ferrous metals which also satisfies the most stringent requirements. Developed in collaboration with professional users, this grinding material features an impressively long service life and high performance and is cost-effective to use. Heavy polyester fabric, fully bonded with artificial resins, with zirconium corundum.  
150 x 2 400 mm

Grain	No. in pack pcs	Part number	Price in €
36	10	6 99 03 112 00 0	188,20

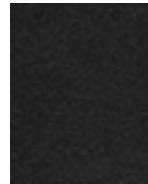

**Grinding material A**

Grinding belts with fine grit for fine grinding of metals to final finish. For the best surface results. Heavy cotton fabric, fully bonded with artificial resins, with corundum.  
75 x 2 000 mm

Grain	No. in pack pcs	Part number	Price in €
220	10	6 99 03 017 00 0	57,58
320	10	6 99 03 018 00 0	57,58
400	10	6 99 03 019 00 0	57,58



**Grinding material A**

Grinding belts with fine grit for fine grinding of metals to final finish. For the best surface results. Heavy cotton fabric, fully bonded with artificial resins, with corundum.  
150 x 2 000 mm

Grain	No. in pack pcs	Part number	Price in €
220	10	6 99 03 050 00 0	109,03
320	10	6 99 03 051 00 0	109,03
400	10	6 99 03 052 00 0	109,03

**Fleece strips**

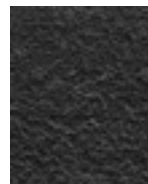

**Fleece belt**

Reliable for everything from covering up minor mistakes to a perfect finish. Long service lives make for cost-effective working.  
75 x 2 000 mm

Model	No. in pack pcs	Part number	Price in €
very fine	3	6 99 03 121 01 0	160,39
medium	3	6 99 03 119 01 0	160,39
course	3	6 99 03 117 01 0	160,39

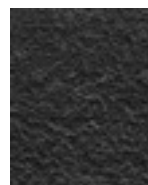

**Fleece belt**

Reliable for everything from covering up minor mistakes to a perfect finish. Long service lives make for cost-effective working.  
150 x 2 000 mm

Model	No. in pack pcs	Part number	Price in €
very fine	3	6 99 03 120 01 0	320,73
medium	3	6 99 03 118 01 0	320,73
course	3	6 99 03 116 01 0	320,73

**Accessories for GRIT GI 75 / GI 75 2H**

**Stainless steel sanding support**  
GX 75

Part number	Price in €
6 99 02 338 00 0	132,65

**Graphite pad**  
As sliding base for surface grinding.

No. in pack pcs	Part number	Price in €
5	3 90 00 000 00 1	77,69

**Eye protection**  
Acrylic screen for protection against sparks

No. in pack pcs	Part number	Price in €
3	3 90 00 000 00 4	34,94

**Dust collector**  
For extinguishing sparks, metal lid for hose connection, plastic, handles on the sides, capacity approx. 20 l.

Part number	Price in €
6 99 02 343 00 0	86,51

**Accessories GRIT GXR**

**Stainless steel jaws**  
Interchangeable, for vice when machining stainless steel.

Part number	Price in €
6 99 02 004 00 0	129,87



**Length stop**  
1 000 mm long, continuously variable, easy to fit

Part number	Price in €
6 99 02 001 00 0	138,60



**Contact roller**  
Long service lives, low roll resistance thanks to high-quality ball bearings, easy to interchange

Ø mm	Part number	Price in €
16	6 99 02 020 00 0	88,27
17	6 99 02 021 00 0	88,27
17,2	6 99 02 022 00 0	88,27
18	6 99 02 023 00 0	88,27
19	6 99 02 024 00 0	88,27
20	6 99 02 025 00 0	88,27
21	6 99 02 026 00 0	88,27
21,3	6 99 02 027 00 0	88,27
22	6 99 02 028 00 0	88,27
22,2	6 99 02 029 00 0	88,27
22,5	6 99 02 030 00 0	88,27
23	6 99 02 031 00 0	88,27
23,1	6 99 02 032 00 0	88,27
24	6 99 02 033 00 0	88,27
24,5	6 99 02 034 00 0	88,27
25	6 99 02 035 00 0	88,27
25,4	6 99 02 036 00 0	88,27
25,9	6 99 02 037 00 0	88,27
26	6 99 02 038 00 0	88,27
26,4	6 99 02 039 00 0	88,27
26,9	6 99 02 040 00 0	88,27
27	6 99 02 041 00 0	88,27
28	6 99 02 042 00 0	88,27
28,6	6 99 02 043 00 0	88,27

28,8	6 99 02 044 00 0	88,27
29	6 99 02 045 00 0	88,27
30	6 99 02 046 00 0	88,27
31,7	6 99 02 047 00 0	88,27
32	6 99 02 048 00 0	88,27
33	6 99 02 049 00 0	88,27
33,7	6 99 02 050 00 0	88,27
34	6 99 02 051 00 0	88,27
35	6 99 02 052 00 0	88,27
36	6 99 02 053 00 0	88,27
37,5	6 99 02 054 00 0	88,27
38	6 99 02 055 00 0	88,27
38,1	6 99 02 056 00 0	88,27
38,3	6 99 02 057 00 0	88,27
40	6 99 02 058 00 0	88,27
41	6 99 02 059 00 0	88,27
41,2	6 99 02 060 00 0	88,27
42	6 99 02 061 00 0	88,27
42,4	6 99 02 062 00 0	88,27
42,6	6 99 02 063 00 0	88,27
43	6 99 02 064 00 0	88,27
43,3	6 99 02 065 00 0	88,27
44	6 99 02 066 00 0	88,27
44,5	6 99 02 067 00 0	88,27
45	6 99 02 068 00 0	88,27
46	6 99 02 069 00 0	88,27
48	6 99 02 070 00 0	88,27
48,3	6 99 02 071 00 0	88,27
49	6 99 02 072 00 0	88,27
50	6 99 02 073 00 0	88,27
50,8	6 99 02 074 00 0	108,75
51	6 99 02 075 00 0	108,75
53	6 99 02 076 00 0	108,75
53,7	6 99 02 077 00 0	108,75
54	6 99 02 078 00 0	108,75
55	6 99 02 079 00 0	108,75
57	6 99 02 080 00 0	108,75
58	6 99 02 081 00 0	108,75
59	6 99 02 082 00 0	108,75
60	6 99 02 083 00 0	108,75
60,3	6 99 02 084 00 0	108,75
63	6 99 02 085 00 0	108,75
63,5	6 99 02 086 00 0	108,75
65	6 99 02 087 00 0	108,75
67	6 99 02 088 00 0	108,75
69	6 99 02 089 00 0	108,75
70	6 99 02 090 00 0	108,75
73	6 99 02 091 00 0	108,75
75	6 99 02 092 00 0	108,75
76	6 99 02 093 00 0	124,10
76,1	6 99 02 094 00 0	124,10
76,2	6 99 02 095 00 0	124,10
80	6 99 02 096 00 0	124,10
82,5	6 99 02 097 00 0	124,10
88,9	6 99 02 098 00 0	124,10
90	6 99 02 099 00 0	124,10

**Eye protection GUT5/GR/GXR (3 pieces)**

Part number	Price in €
3 90 00 000 00 7	56,21

**Connecting piece**  
Required for adapting the GXR module to a belt grinder of the GI program

Part number	Price in €
6 99 02 186 00 0	70,35



**Accessories for machines GXC**

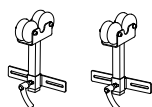

**Pipe support**  
Ø 10-130 mm

Part number	Price in €
6 99 02 179 60 0	207,61

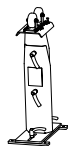

**Pipe support**  
Ø 10-160 mm  
Can be combined with one another depending on the pipe length desired.

max. pipe length mm	Part number	Price in €
1 000	6 99 02 180 60 0	337,55



**Pipe support**  
Ø 10-160 mm  
Can be combined with one another depending on the pipe length desired.

max. pipe length mm	Part number	Price in €
1 500	6 99 02 181 60 0	843,90



**Guide rail, brass**  
For dry grinding and course material surfaces

Part number	Price in €
3 90 00 000 49 6	39,90



**Nylon glide support**  
For high surface quality

Part number	Price in €
3 90 00 000 49 7	42,27

**Connecting piece**  
Required for adapting the GXC module to a belt grinder of the GI program

Part number	Price in €
6 99 02 187 00 0	82,95

**Accessories GRIT GXE**

**Stainless steel sanding support**  
GXE

Part number	Price in €
6 99 02 344 00 0	46,13



**Steel wire brush**  
Ø 250 mm x 60 mm, with very high wire drawing strength for highly efficient use, mounting hole Ø 51 mm. 0.2 mm thick wire for thin-walled pipes and profiles. 0.35 mm-thick wire for universal use. 0.5 mm thick wire for thick-walled pipes and profiles and great deburring results.  
Steel version

Wire thickness mm	Part number	Price in €
0,2	6 99 02 006 00 0	168,35
0,35	6 99 02 007 00 0	153,99
0,5	6 99 02 008 00 0	153,99



**Steel wire brush**  
Ø 250 mm x 60 mm, with very high wire drawing strength for highly efficient use, mounting hole Ø 51 mm. 0.2 mm thick wire for thin-walled pipes and profiles. 0.35 mm-thick wire for universal use. 0.5 mm thick wire for thick-walled pipes and profiles and great deburring results.  
Stainless steel version

Wire thickness mm	Part number	Price in €
0,2	6 99 02 009 00 0	297,56
0,35	6 99 02 010 00 0	259,70

**Eye protection**  
Acrylic screen for protection against sparks

No. in pack pcs	Part number	Price in €
3	3 90 00 000 00 4	34,94

**Accessories GRIT GXW**

**Grinding/cooling emulsion**  
Concentrate, 10 l, mixing ratio 1:30, yields 300 l of ready-to-use cooling lubricant.

Part number	Price in €
6 99 02 100 00 0	249,49

**Other GRIT GX accessories**

**Hose**  
Flexible, for swarf extraction, 90 mm in diameter, 1 m long, steel, high level of heat resistance.

Part number	Price in €
3 90 00 000 00 2	40,98

**Tube clamps**  
For securing the flexible hose.

Part number	Price in €
3 90 00 000 00 3	5,49

**Dust container**  
For extinguishing sparks, metal lid for hose connection, plastic, handles on the sides, capacity approx. 20 l.

Part number	Price in €
6 99 02 000 00 0	85,72

**Device for dust extract**  
GXS

Part number	Price in €
6 99 02 000 14 7	337,55

**Accessories for GRIT GI 75 / GI 75 2H**

**Graphite pad**  
As sliding base for surface grinding.

No. in pack pcs	Part number	Price in €
5	3 90 00 000 00 1	77,69

**Eye protection GU75/GR/GXR (3 pieces)**

Part number	Price in €
3 90 00 000 00 7	56,21

**Mitre joint unit for preparation of welded seams**  
GI/GIS 75

Part number	Price in €
6 99 02 000 15 0	196,63

**Stainless steel sanding support**  
GI/GIS 75

Part number	Price in €
6 99 02 000 14 8	148,56



## Accessories for GRIT GI 150 / GI 150 2H

### Graphite coating

Part number	Price in €
3 90 00 000 05 6	89,34

### Mitre joint unit for preparation of welded seams GI/GIS 150

Part number	Price in €
6 99 02 000 15 1	218,48

### Stainless steel sanding support GI/GIS 150

Part number	Price in €
6 99 02 000 14 9	170,42

### Eye protection

Part number	Price in €
3 90 00 000 18 4	67,22

## Accessories for GRIT GIR



### Contact roller

Long service lives, low roll resistance thanks to high-quality ball bearings, easy to interchange

Ø mm	Part number	Price in €
20	6 99 02 101 00 0	126,68
22	6 99 02 102 00 0	126,68
25	6 99 02 103 00 0	126,68
25,4	6 99 02 104 00 0	126,68
26,9	6 99 02 105 00 0	126,68
28	6 99 02 106 00 0	126,68
30	6 99 02 107 00 0	126,68
32	6 99 02 108 00 0	126,68
33,7	6 99 02 109 00 0	126,68
35	6 99 02 110 00 0	126,68
38	6 99 02 111 00 0	126,68
38,1	6 99 02 112 00 0	126,68
38,3	6 99 02 113 00 0	126,68
40	6 99 02 114 00 0	126,68
42,4	6 99 02 115 00 0	126,68
44,5	6 99 02 116 00 0	126,68
48,3	6 99 02 117 00 0	126,68
50	6 99 02 118 00 0	126,68
50,8	6 99 02 119 00 0	144,57
60	6 99 02 120 00 0	144,57
60,3	6 99 02 121 00 0	144,57
63,5	6 99 02 122 00 0	144,57
69	6 99 02 123 00 0	144,57
76,1	6 99 02 124 00 0	198,31
76,2	6 99 02 125 00 0	198,31
84	6 99 02 126 00 0	198,31
88,9	6 99 02 127 00 0	198,31
101,6	6 99 02 128 00 0	198,31
104	6 99 02 129 00 0	271,25
108	6 99 02 130 00 0	271,25
114,3	6 99 02 131 00 0	271,25
133	6 99 02 132 00 0	598,76
139,7	6 99 02 133 00 0	598,76
168,3	6 99 02 134 00 0	655,06
193,7	6 99 02 000 18 7	441,00

### Connecting piece

Required for adapting the GXC module to a belt grinder of the GI program

Part number	Price in €
6 99 02 187 00 0	82,95

### Eye protection

Part number	Price in €
3 90 00 000 18 4	67,22

### Mitre grinding plate GIG

For precision mitre joint grinding, easy assembly.

Part number	Price in €
6 99 02 175 00 0	280,35

### Adaptor

For optimum extraction, for connection to the machine base GRIT GIBE with double extraction.

Part number	Price in €
6 99 02 182 00 0	135,45

## Accessories for GRIT GIE



### Steel wire brush

Ø 250 mm x 60 mm, with very high wire drawing strength for highly efficient use, mounting hole Ø 51 mm. 0.2 mm thick wire for thin-walled pipes and profiles. 0.35 mm-thick wire for universal use. 0.5 mm thick wire for thick-walled pipes and profiles and great deburring results.  
Steel version

Wire thickness mm	Part number	Price in €
0,2	6 99 02 006 00 0	168,35
0,35	6 99 02 007 00 0	153,99
0,5	6 99 02 008 00 0	153,99



### Steel wire brush

Ø 250 mm x 60 mm, with very high wire drawing strength for highly efficient use, mounting hole Ø 51 mm. 0.2 mm thick wire for thin-walled pipes and profiles. 0.35 mm-thick wire for universal use. 0.5 mm thick wire for thick-walled pipes and profiles and great deburring results.  
Stainless steel version

Wire thickness mm	Part number	Price in €
0,2	6 99 02 009 00 0	297,56
0,35	6 99 02 010 00 0	259,70

### Eye protection GU75/GR/GXR (3 pieces)

Part number	Price in €
3 90 00 000 00 7	56,21

### Cassette filter

Suitable for GRIT GIBE.

Part number	Price in €
3 90 00 000 97 6	111,65

### Cassette filter

Suitable for GRIT GIXBE.

Part number	Price in €
3 90 00 001 10 1	112,78





**GRIT GIC accessories**

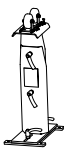

**Pipe support**

Ø 10-160 mm  
Can be combined with one another depending on the pipe length desired.

max. pipe length mm	Part number	Price in €
1 000	6 99 02 180 60 0	337,55



**Pipe support**

Ø 10-160 mm  
Can be combined with one another depending on the pipe length desired.

max. pipe length mm	Part number	Price in €
1 500	6 99 02 181 60 0	843,90

**Drilling template**

For fitting on belt grinders GI 75 / GI 75 2H from before the 1034026 series. For subsequent threaded bores on these belt grinders.

Part number	Price in €
3 90 00 004 55 4	19,20



**Guide rail, brass**

For dry grinding and course material surfaces

Part number	Price in €
3 90 00 000 49 6	39,90



**Nylon glide support**

For high surface quality

Part number	Price in €
3 90 00 000 49 7	42,27

**Grinding/cooling emulsion**

Concentrate, 10 l, mixing ratio 1:30, yields 300 l of ready-to-use cooling lubricant.

Part number	Price in €
6 99 02 100 00 0	249,49

**GRIT GIL accessories**

**Graphite pad**

As sliding base for surface grinding.

No. in pack pcs	Part number	Price in €
4	3 90 00 004 76 0	15,45

**Other accessories GRIT GI**

**Hose**

Flexible, for swarf extraction, 90 mm in diameter, 1 m long, steel, high level of heat resistance.

Part number	Price in €
3 90 00 000 00 2	40,98

**Tube clamps**

For securing the flexible hose.

Part number	Price in €
3 90 00 000 00 3	5,49

**Dust container**

For extinguishing sparks, metal lid for hose connection, plastic, handles on the sides, capacity approx. 20 l.

Part number	Price in €
6 99 02 000 00 0	85,72

**Device for dust extract**

GXS

Part number	Price in €
6 99 02 000 14 7	337,55

**Contact disc**

Ø 200 x 50 mm  
90 shore, grooved

Part number	Price in €
6 99 02 346 00 0	251,66

**Drive wheel puller**

Part number	Price in €
6 99 02 410 00 0	63,00

**Swivel joint GIT for GIL**

For adapting working area to tight spaces, continuously variable swivel range of up to 90°.

Part number	Price in €
6 99 02 176 00 0	247,80

**Plugbox 2 x 7 poles**

Part number	Price in €
6 99 02 183 00 0	109,20

**Connecting piece**

Required for adapting the GXC module to a belt grinder of the GI program

Part number	Price in €
6 99 02 187 00 0	82,95

**Jawset vice**

Part number	Price in €
6 99 02 335 00 0	236,25





## Practical, useful and sometimes essential: the FEIN tailored accessory.

With over 150 years of experience in building power tools, we know what really matters for the most diverse applications and in every industry. This also explains why so much is included in the the basic models of FEIN power tools and why some things are only available as optional accessories. Because what seems indispensable to one person might be superfluous to another. We know that from experience.



---

### Balancers

Page 270

Balancers increase operating comfort and safety.  
For loads of 0.5 kg - 60 kg.

**Balancer up to 1.5 kg**

Safe suspension of device and power line in "weightless" state.

Variable load	kg	0,5 - 1,5
Factory setting	kg	1
max. stroke	m	0,9
Model		Stable nylon cable
Weight	kg	0,35
<b>Part number</b>		<b>9 08 01 012 00 8</b>
<b>EAN</b>		<b>4014586835075</b>
<b>Price in € [PC01]</b>		<b>64,05</b>

**FEIN benefits:**

- ▶ Small size.
- ▶ Constant traction.
- ▶ Easily adjustable.
- ▶ Stable nylon cable.
- ▶ Spiral cordset available as accessory

For accessories, see page 273

**Balancer up to 1.5 kg**

Safe suspension of device and power line in "weightless" state.

Variable load	kg	0,5 - 1,5
Factory setting	kg	1
max. stroke	m	0,9
Model		Wire cable
Weight	kg	0,35
<b>Part number</b>		<b>9 08 01 052 00 4</b>
<b>EAN</b>		<b>4014586854052</b>
<b>Price in € [PC01]</b>		<b>74,55</b>

**FEIN benefits:**

- ▶ Constant traction.
- ▶ Tear-resistant steel cable.
- ▶ Spiral cordset available as accessory

For accessories, see page 273

**Balancer up to 2,5 kg**

Safe suspension of device and power line in "weightless" state.

Variable load	kg	1,5 - 2,5
Factory setting	kg	2
max. stroke	m	0,9
Model		Stable nylon cable
Weight	kg	0,35
<b>Part number</b>		<b>9 08 01 023 00 1</b>
<b>EAN</b>		<b>4014586835099</b>
<b>Price in € [PC01]</b>		<b>74,55</b>

**FEIN benefits:**

- ▶ Small size.
- ▶ Constant traction.
- ▶ Easily adjustable.
- ▶ Stable nylon cable.
- ▶ Spiral cordset available as accessory

For accessories, see page 273

**Balancer up to 2,5 kg**

Safe suspension of device and power line in "weightless" state.

Variable load	kg	1,5 - 2,5
Factory setting	kg	2
max. stroke	m	0,9
Model		Wire cable
Weight	kg	0,35
<b>Part number</b>		<b>9 08 01 037 00 9</b>
<b>EAN</b>		<b>4014586835228</b>
<b>Price in € [PC01]</b>		<b>79,80</b>

**FEIN benefits:**

- ▶ Constant traction.
- ▶ Tear-resistant steel cable.
- ▶ Spiral cordset available as accessory

For accessories, see page 273

**Balancer up to 3 kg**

Safe suspension of device and power line in "weightless" state.

Variable load	kg	1 - 3
Factory setting	kg	2
max. stroke	m	2
Model		Wire cable
Weight	kg	3,2
<b>Part number</b>		<b>9 08 01 024 00 9</b>
<b>EAN</b>		<b>4014586835105</b>
<b>Price in € [PC01]</b>		<b>170,10</b>

**FEIN benefits:**

- ▶ Constant traction.
- ▶ Tear-resistant steel cable.
- ▶ Spiral cordset available as accessory

For accessories, see page 273

**Balancer up to 5 kg**

Safe suspension of device and power line in "weightless" state.



Variable load	kg	2,5 - 5
Factory setting	kg	3,5
max. stroke	m	2
Model		Wire cable
Weight	kg	3,2
<b>Part number</b>		<b>9 08 01 025 00 3</b>
<b>EAN</b>		<b>4014586835136</b>
<b>Price in € [PC01]</b>		<b>177,45</b>

**FEIN benefits:**

- ▶ Constant traction.
- ▶ Tear-resistant steel cable.
- ▶ Spiral cordset available as accessory

For accessories, see page 273

**Balancer up to 6,5 kg**

Safe suspension of device and power line in "weightless" state.



Variable load	kg	3,5 - 6,5
Factory setting	kg	5
max. stroke	m	2
Model		Wire cable
Weight	kg	3,2
<b>Part number</b>		<b>9 08 01 026 00 6</b>
<b>EAN</b>		<b>4014586835143</b>
<b>Price in € [PC01]</b>		<b>192,15</b>

**FEIN benefits:**

- ▶ Constant traction.
- ▶ Tear-resistant steel cable.
- ▶ Spiral cordset available as accessory

For accessories, see page 273

**Balancer up to 9 kg**

Safe suspension of device and power line in "weightless" state.



Variable load	kg	4,5 - 9
Factory setting	kg	7
max. stroke	m	2
Model		Wire cable
Weight	kg	3,2
<b>Part number</b>		<b>9 08 01 027 00 0</b>
<b>EAN</b>		<b>4014586835150</b>
<b>Price in € [PC01]</b>		<b>205,80</b>

**FEIN benefits:**

- ▶ Constant traction.
- ▶ Tear-resistant steel cable.
- ▶ Spiral cordset available as accessory

For accessories, see page 273

**Balancer up to 11 kg**

Safe suspension of device and power line in "weightless" state.



Variable load	kg	7,5 - 11
Factory setting	kg	9
max. stroke	m	2
Model		Wire cable
Weight	kg	3,2
<b>Part number</b>		<b>9 08 01 028 00 8</b>
<b>EAN</b>		<b>4014586835167</b>
<b>Price in € [PC01]</b>		<b>216,30</b>

**FEIN benefits:**

- ▶ Constant traction.
- ▶ Tear-resistant steel cable.
- ▶ Spiral cordset available as accessory

For accessories, see page 273

**Balancer up to 14 kg**

Safe suspension of device and power line in "weightless" state.



Variable load	kg	10 - 14
Factory setting	kg	12
max. stroke	m	2
Model		Wire cable
Weight	kg	3,2
<b>Part number</b>		<b>9 08 01 029 00 2</b>
<b>EAN</b>		<b>4014586835174</b>
<b>Price in € [PC01]</b>		<b>223,65</b>

**FEIN benefits:**

- ▶ Constant traction.
- ▶ Tear-resistant steel cable.
- ▶ Spiral cordset available as accessory

For accessories, see page 273

**Balancer up to 17 kg**

Safe suspension of device and power line in "weightless" state.



Variable load	kg	13,5 - 17
Factory setting	kg	15
max. stroke	m	2
Model		Wire cable
Weight	kg	3,2
<b>Part number</b>		<b>9 08 01 030 00 4</b>
<b>EAN</b>		<b>4014586835181</b>
<b>Price in € [PC01]</b>		<b>229,95</b>

**FEIN benefits:**

- ▶ Constant traction.
- ▶ Tear-resistant steel cable.
- ▶ Spiral cordset available as accessory

For accessories, see page 273

**Balancer up to 25 kg**

Safe suspension of device and power line in "weightless" state.



Variable load	kg	13 - 25
Factory setting	kg	15
max. stroke	m	1,9
Model		Wire cable
Weight	kg	11,2
<b>Part number</b>		<b>9 08 01 055 00 0</b>
<b>EAN</b>		<b>4014586880693</b>
<b>Price in € [PC01]</b>		<b>649,95</b>

**FEIN benefits:**

- ▶ Constant traction.
- ▶ Tear-resistant steel cable.
- ▶ Spiral cordset available as accessory

For accessories, see page 273

**Balancer up to 32 kg**

Safe suspension of device and power line in "weightless" state.



Variable load	kg	22 - 32
Factory setting	kg	25
max. stroke	m	1,9
Model		Wire cable
Weight	kg	11,5
<b>Part number</b>		<b>9 08 01 056 00 0</b>
<b>EAN</b>		<b>4014586880709</b>
<b>Price in € [PC01]</b>		<b>730,80</b>

**FEIN benefits:**

- ▶ Constant traction.
- ▶ Tear-resistant steel cable.
- ▶ Spiral cordset available as accessory

For accessories, see page 273

**Balancer up to 45 kg**

Safe suspension of device and power line in "weightless" state.



Variable load	kg	30 - 45
Factory setting	kg	40
max. stroke	m	1,9
Model		Wire cable
Weight	kg	12
<b>Part number</b>		<b>9 08 01 057 00 0</b>
<b>EAN</b>		<b>4014586880716</b>
<b>Price in € [PC01]</b>		<b>891,45</b>

**FEIN benefits:**

- ▶ Constant traction.
- ▶ Tear-resistant steel cable.
- ▶ Spiral cordset available as accessory

For accessories, see page 273

**Balancer up to 60 kg**

Safe suspension of device and power line in "weightless" state.



Variable load	kg	45 - 60
Factory setting	kg	50
max. stroke	m	1,9
Model		Wire cable
Weight	kg	12,4
<b>Part number</b>		<b>9 08 01 058 00 0</b>
<b>EAN</b>		<b>4014586880723</b>
<b>Price in € [PC01]</b>		<b>1.060,50</b>

**FEIN benefits:**

- ▶ Constant traction.
- ▶ Tear-resistant steel cable.
- ▶ Spiral cordset available as accessory

For accessories, see page 273

**Balancers****General accessories****Spiral cordset**for electric tools with mains connection cables of quality  
HO 5 RN-F 2 x 1.Part number  
3 07 07 157 03 5Price in €  
30,14**Balancer up to 60 kg****Locking device**for locking the extended cable. eases the exchange of the  
hooked on tool.Part number  
3 02 40 239 01 4Price in €  
66,72**Swivel hook**

to hook on the rope eye. Prevents the rope from twisting.

Part number  
3 02 32 044 01 0Price in €  
125,88



Part number	EAN	Description	Price in €	PC	Page
7 105 01 62 00 0	4014586881744	ABOP 6 Select	261,45	01	54
7 105 02 62 00 0	4014586881751	ABOP 10 Select	261,45	01	54
7 105 03 62 00 0	4014586881768	ABOP 13-2 Select	313,95	01	55
7 105 04 62 00 0	4014586881775	AWBP 10 Select	324,45	01	55
7 109 01 62 00 0	4014586885537	AGWP 10 Select	408,45	01	57
7 112 28 00 95 0	4014586876238	ASM 14-6 (without battery)	523,95	05	28
7 112 40 00 95 0	4014586876245	ASW 14-6 (without battery and angled head)	523,95	05	31
7 112 42 00 95 0	4014586876252	ASW 14-10 (without battery and angled head)	523,95	05	31
7 112 50 00 95 0	4014586874210	ASW 14-6 PC (without battery and angled head)	699,30	05	32
7 112 51 00 95 0	4014586874227	ASW 14-10 PC (without battery and angled head)	699,30	05	32
7 112 52 00 95 0	4014586874234	ASW 14-14 PC (without battery and angled head)	699,30	05	32
7 112 54 00 95 0	4014586874241	ASM 14-6 PC (without battery)	681,45	05	29
7 112 55 00 95 0	4014586874258	ASM 14-9 PC (without battery)	681,45	05	29
7 112 56 00 95 0	4014586874265	ASM 14-12 PC (without battery)	681,45	05	29
7 112 57 00 95 0	4014586877198	ASM 14-12 (without battery)	523,95	05	28
7 112 58 00 95 0	4014586877204	ASW 14-14 (without battery and angled head)	523,95	05	31
7 112 59 00 95 0	4014586877211	ASM 14-9 (without battery)	523,95	05	28
7 112 60 00 95 0	4014586881294	ASM 14-2 (without battery)	523,95	05	28
7 112 61 00 95 0	4014586881317	ASM 14-2 PC (without battery)	681,45	05	29
7 112 62 60 00 0	4014586883830	ASW 18-30 PC (without battery and angled head)	1.102,50	05	33
7 112 63 60 00 0	4014586883847	ASW 18-45 PC (without battery and angled head)	1.155,00	05	33
7 112 64 60 00 0	4014586883854	ASW 18-60 PC (without battery and angled head)	1.207,50	05	33
7 113 11 63 00 0	4014586881461	ASCS 6.3 Select	261,45	01	17
7 113 16 64 00 0	4014586887555	ASCT 18 M Select	376,95	01	17
7 113 16 65 00 0	4014586887562	ASCT 18 Select	271,95	01	18
7 113 20 61 00 0	4014586881485	ABSU 12 C	182,70	18	12
7 113 20 64 00 0	4014586885568	ABSU 12 Select	80,85	18	13
7 113 21 61 00 0	4014586881539	ABSU 12 W4C	177,45	18	13
7 113 21 64 00 0	4014586885575	ABSU 12 W4 Select	75,60	18	13
7 113 22 62 00 0	4014586887159	ABS 18 QC	405,30	18	9
7 113 22 63 00 0	4014586887197	Professional set for ABS 18 QC tapping	510,30	18	10
7 113 22 64 00 0	4014586887203	ABS 18 Q Select	219,45	18	10
7 115 03 61 00 0	4014586881560	ASCD 12-100 W4C	229,95	18	25
7 115 03 64 00 0	4014586885582	ASCD 12-100 W4 Select	128,10	18	25
7 115 04 61 00 0	4014586887371	ASCD 12-150 W8C	271,95	18	23
7 115 04 64 00 0	4014586887388	ASCD 12-150 W8 Select	170,10	18	23
7 115 05 61 00 0	4014586887395	ASCD 12-150 W4C	261,45	18	24
7 115 05 64 00 0	4014586887401	ASCD 12-150 W4 Select	159,60	18	24
7 115 06 61 00 0	4014586887418	ASCD 18-300 W2	510,30	18	22
7 115 06 64 00 0	4014586887425	ASCD 18-300 W2 Select	261,45	18	22
7 115 07 61 00 0	4014586887432	ASCD 18-200 W4	499,80	18	22
7 115 07 64 00 0	4014586887449	ASCD 18-200 W4 Select	250,95	18	23
7 116 10 61 00 0	4014586881447	ASCM 12 QC	271,95	18	11
7 116 10 62 00 0	4014586886961	Professional set for ASCM 12 QC tapping	376,95	18	12
7 116 10 64 00 0	4014586885698	ASCM 12 Q Select	170,10	18	11
7 116 11 61 00 0	4014586887456	ASCM 18 QM	510,30	18	8
7 116 11 63 00 0	4014586887333	Professional set for ASCM 18 QC tapping	615,30	18	9
7 116 11 64 00 0	4014586887340	ASCM 18 QM Select	261,45	18	8
7 129 18 61 00 0	4014586884004	FEIN cordless SUPERCUT AFSC 1.7 Q Auto Glass	597,45	03	46
7 129 18 62 00 0	4014586885186	FEIN cordless SUPERCUT AFSC 1.7 QC	418,95	03	46
7 129 18 63 00 0	4014586885209	FEIN cordless SUPERCUT AFSC 1.7 Q	492,45	03	45
7 129 22 61 00 0	4014586884066	FEIN cordless MULTIMASTER AFMM 18 QSL	363,30	03	37
7 129 22 62 00 0	4014586885704	FEIN cordless MULTIMASTER AFMM 18 QSL Select	177,45	03	37
7 129 25 61 00 0	4014586884141	FEIN cordless MULTITALENT AFMT 12 QSL QuickStart	256,20	03	38
7 129 25 62 00 0	4014586885711	FEIN cordless MULTITALENT AFMT 12 QSL Select	154,35	03	39
7 129 26 61 00 0	4014586884226	FEIN cordless MULTITALENT AFMT 12 SL Start	235,20	03	38
7 129 27 60 00 0	4014586884295	FEIN cordless SUPERCUT AFSC 18 QSL Select	250,95	03	43
7 129 27 61 00 0	4014586884301	FEIN cordless SUPERCUT AFSC 18 QSL	499,80	03	42
7 129 27 62 00 0	4014586884349	FEIN cordless SUPERCUT AFSC 18 QCSL	436,80	03	42
7 129 27 64 00 0	4014586884387	FEIN cordless SUPERCUT AFSC 18 QSL for interior work with wood	609,00	03	43
7 129 27 66 00 0	4014586884424	FEIN cordless SUPERCUT AFSC 18 QSL for repairing/replacing windows	609,00	03	44
7 129 27 67 00 0	4014586884431	FEIN cordless SUPERCUT AFSC 18 QSL for tile restoration/bathroom renovation	609,00	03	44
7 129 27 68 00 0	4014586884448	FEIN cordless SUPERCUT AFSC 18 QSL for heating/sanitary installation	609,00	03	45
7 130 03 61 00 0	4014586886640	ABSS 18 1.6 E Select	523,95	01	49
7 130 04 61 00 0	4014586886664	ABLS 18 1.6 E Select	471,45	01	49
7 132 04 61 00 0	4014586886688	ABLK 18 1.6 E Select	471,45	01	49
7 132 05 61 00 0	4014586886701	ABLK 18 1.3 CSE Select	471,45	01	50
7 132 06 61 00 0	4014586886725	ABLK 18 1.3 TE Select	471,45	01	50
7 144 01 61 00 0	4014586872544	SuperWire	1.258,95	01	59
7 144 01 62 00 0	4014586872568	SuperWire (without battery or charger)	1.153,95	01	59
7 202 06 00 22 9	4014586802749	DDSk 672	1.487,85	01	69
7 202 09 00 22 7	4014586802855	DSke 672	1.262,10	01	69
7 205 01 00 22 8	4014586804453	DDSk 672-1	1.534,05	01	69
7 205 03 00 22 0	4014586804569	ASq 672-1	1.733,55	01	70
7 205 47 60 00 0	4014586874463	BOS 16	433,65	01	68



Part number	EAN	Description	Price in €	PC	Page
7 205 49 60 00 0	4014586876443	BOS 16-2	499,80	01	68
7 205 51 60 00 0	4014586878843	WBP 10	326,55	01	72
7 205 52 60 00 0	4014586882413	BOP 6	269,85	01	64
7 205 52 61 00 0	4014586881973	BOP 6	292,95	01	64
7 205 53 60 00 0	4014586882468	BOP 10	269,85	01	65
7 205 53 61 00 0	4014586881980	BOP 10	292,95	01	65
7 205 54 60 00 0	4014586882512	BOP 10-2	328,65	01	66
7 205 54 61 00 0	4014586881997	BOP 10-2	351,75	01	66
7 205 55 60 00 0	4014586882567	BOP 13-2	342,30	01	67
7 205 55 61 00 0	4014586882017	BOP 13-2	368,55	01	67
7 209 38 60 00 0	4014586881256	GWP 10	598,50	01	76
7 213 04 00 23 9	4014586853734	SCS 4.8-25	315,00	01	80
7 213 06 50 01 8	4014586854205	SCT 5-40 M	362,25	01	82
7 213 13 00 23 0	4014586860923	SCT 5-40 X	249,90	01	82
7 220 78 00 22 5	4014586811260	MSf 636-1	576,45	01	190
7 221 05 00 23 7	4014586851242	WSB 20-180	331,80	01	96
7 221 05 29 23 2	4014586851792	WSB 20-180	331,80	01	-
7 221 06 00 23 0	4014586851259	WSB 20-230	331,80	01	96
7 221 06 29 23 5	4014586851815	WSB 20-230	331,80	01	-
7 221 07 00 23 6	4014586851266	WSG 20-180	284,55	01	96
7 221 07 29 23 1	4014586851839	WSG 20-180	288,75	01	-
7 221 08 00 23 2	4014586851273	WSG 20-230	288,75	01	97
7 221 08 29 23 7	4014586851853	WSG 20-230	288,75	01	-
7 221 10 00 23 3	4014586853116	WSB 25-180 X	412,65	01	97
7 221 10 29 23 8	4014586853246	WSB 25-180 X	412,65	01	-
7 221 10 99 23 1	4014586853253	WSB 25-180 X	412,65	01	-
7 221 11 00 23 2	4014586853123	WSB 25-230 X	412,65	01	97
7 221 11 29 23 7	4014586853314	WSB 25-230 X	412,65	01	-
7 221 11 99 23 0	4014586853321	WSB 25-230 X	412,65	01	-
7 221 13 50 01 4	4014586853819	RS 12-70 E	1.132,95	01	190
7 221 13 51 01 3	4014586853826	RS 12-70 E - Professional stainless steel set	1.332,45	01	190
7 221 26 00 23 0	4014586856452	WSG 25-180	367,50	01	98
7 221 26 29 23 0	4014586856490	WSG 25-180	367,50	01	-
7 221 26 99 23 0	4014586857596	WSG 25-180	367,50	01	-
7 221 27 00 23 0	4014586856506	WSG 25-230	367,50	01	98
7 221 27 29 23 0	4014586856544	WSG 25-230	367,50	01	-
7 221 31 00 23 0	4014586858371	MSfv 649-1	676,20	01	88
7 221 48 00 23 0	4014586862699	WPO 14-15 E	418,95	01	203
7 221 48 50 01 0	4014586862712	WPO 14-15 E marine polishing set	522,90	01	203
7 221 48 51 01 0	4014586867069	WPO 14-15 E Set	430,50	01	203
7 221 48 60 00 0	4014586872216	WPO 14-15 E marine polishing set	399,00	01	204
7 221 49 00 23 0	4014586862729	WPO 14-25 E	418,95	01	191
7 221 49 50 01 0	4014586862743	WPO 14-25 E - Stainless steel start set	719,25	01	191
7 221 49 51 01 0	4014586867113	WPO 14-25 E	430,50	01	204
7 221 63 00 23 0	4014586866055	WPO 10-25 E	375,90	01	204
7 221 63 51 01 0	4014586867199	WPO 10-25 E Set	387,45	01	205
7 221 65 50 01 0	4014586867236	ROT 14-200 E	568,05	01	191
7 221 66 60 00 0	4014586867519	RS 10-70 E Start set	1.090,95	01	192
7 221 67 60 00 0	4014586868936	KS 10-38 E set	740,25	01	192
7 221 73 60 00 0	4014586875033	WSG 8-115	114,45	19	88
7 221 74 60 00 0	4014586875125	WSG 8-125	116,55	19	88
7 221 75 60 00 0	4014586875217	WSG 12-125 P	162,75	19	89
7 221 76 60 00 0	4014586875309	WSG 12-125 PQ	173,25	19	89
7 221 77 60 00 0	4014586875316	WSG 11-125	130,20	19	89
7 221 78 60 00 0	4014586875323	WSG 15-125 P	183,75	19	89
7 221 79 60 00 0	4014586875330	WSG 15-125 PQ	196,35	19	90
7 221 87 60 00 0	4014586879888	WSG 11-125 RT	162,75	19	90
7 221 90 60 00 0	4014586879970	WSG 15-125 PR	217,35	19	90
7 221 91 60 00 0	4014586880020	WSG 15-125 PRT	217,35	19	90
7 221 98 60 00 0	4014586885506	WSG 7-115	82,95	19	88
7 222 07 60 00 0	4014586883120	WSG 17-125 P	194,25	19	91
7 222 08 60 00 0	4014586883175	WSG 17-125 PQ	204,75	19	91
7 222 09 60 00 0	4014586883236	WSG 17-125 PS	194,25	19	91
7 222 10 60 00 0	4014586883304	WSG 17-125 PSQ	204,75	19	91
7 222 11 60 00 0	4014586883366	WSG 17-150 P	194,25	19	92
7 222 12 60 00 0	4014586883434	WSG 17-150 PQ	204,75	19	92
7 222 13 60 00 0	4014586883496	WSG 17-70 Inox	271,95	19	92
7 222 13 61 00 0	4014586883564	WSG 17-70 Inox starter set	413,70	19	192
7 222 18 60 00 0	4014586883571	WSG 17-125 PR	225,75	19	92
7 222 19 60 00 0	4014586883618	WSG 17-125 PRT	225,75	19	93
7 222 20 60 00 0	4014586883656	WSG 17-150 PR	225,75	19	93
7 222 21 60 00 0	4014586883694	WSG 17-150 PRT	225,75	19	93
7 222 22 60 00 0	4014586883731	WSG 17-70 Inox R	303,45	19	93
7 222 23 60 00 0	4014586883779	WSG 17-70 Inox RT	303,45	19	94
7 223 16 60 00 0	4014586879505	GSZ 8-280 P	217,35	01	102
7 223 17 60 00 0	4014586879437	GSZ 8-280 PE	238,35	01	102

Machines in numerical order

Part number	EAN	Description	Price in €	PC	Page
7 223 18 60 00 0	4014586879598	GSZ 8-280 PL	391,65	01	102
7 223 19 60 00 0	4014586879444	GSZ 8-280 PEL	414,75	01	103
7 223 20 60 00 0	4014586879451	GSZ 8-90 PEL	490,35	01	103
7 223 21 60 00 0	4014586880495	GSZ 11-320 PRL	425,25	01	103
7 223 22 60 00 0	4014586880501	GSZ 11-320 PERL	446,25	01	104
7 223 23 60 00 0	4014586880525	GSZ 11-90 PERL	523,95	01	104
7 223 24 60 00 0	4014586880594	GSZ 4-280 EL	385,35	01	104
7 223 25 60 00 0	4014586880648	GSZ 4-90 EL	385,35	01	105
7 228 05 50 00 0	4014586867250	BF 10-280 E	514,50	01	193
7 228 05 51 00 0	4014586867267	BF 10-280 E Start-Set	604,80	01	193
7 229 46 61 00 0	4014586885247	FEIN SUPERCUT FSC 500 QSL	418,95	03	215
7 229 46 62 00 0	4014586885308	FEIN SUPERCUT FSC 500 QSL for interior work with wood	523,95	03	215
7 229 46 63 00 0	4014586885353	FEIN SUPERCUT FSC 500 QSL for repairing/replacing windows	523,95	03	215
7 229 46 64 00 0	4014586885360	FEIN SUPERCUT FSC 500 QSL for tile restoration/bathroom renovation	523,95	03	216
7 229 46 65 00 0	4014586885407	FEIN SUPERCUT FSC 500 QSL for heating/sanitary installation	523,95	03	216
7 229 46 67 00 0	4014586885414	FEIN SUPERCUT FSC 500 QSL Composite	555,45	03	217
7 229 46 70 00 0	4014586886176	FEIN SUPERCUT FSC 500 QSL for grout renewal	586,95	03	217
7 229 52 61 00 0	4014586884578	FEIN MULTIMASTER FMM 350 QSL Top	278,25	03	211
7 229 52 62 00 0	4014586884691	FEIN MULTIMASTER FMM 350 QSL QuickStart	231,00	03	211
7 229 52 63 00 0	4014586884462	FEIN MULTIMASTER FMM 350 QSL Top Extra	523,95	03	212
7 229 52 66 00 0	4014586884851	FEIN MULTIMASTER FMM 350 QSL Marine	304,50	03	212
7 229 53 61 00 0	4014586884905	FEIN MULTITALENT FMT 250 QSL QuickStart	179,55	03	213
7 229 54 61 00 0	4014586885025	FEIN MULTITALENT FMT 250 SL Start	136,50	03	213
7 230 23 00 23 8	4014586848624	BLS 3.5	1.477,35	01	126
7 230 24 00 23 4	4014586848631	BLS 4.2	1.546,65	01	127
7 230 31 61 00 0	4014586874661	BSS 1.6 E	550,20	01	123
7 230 32 61 00 0	4014586874739	BSS 1.6 CE	612,15	01	123
7 230 33 61 00 0	4014586874807	BSS 2.0 E	758,10	01	123
7 230 34 61 00 0	4014586874876	BLS 1.6 E	513,45	01	126
7 230 35 61 00 0	4014586874944	BLS 2.5 E	786,45	01	126
7 232 30 00 23 0	4014586848655	BLK 3.5	1.456,35	01	131
7 232 31 00 23 9	4014586848662	BLK 5.0	2.212,35	01	131
7 232 38 60 00 0	4014586869858	BLK 1.6 E	535,50	01	129
7 232 39 60 00 0	4014586869926	BLK 1.6 LE	773,85	01	130
7 232 40 60 00 0	4014586869995	BLK 2.0 E	739,20	01	130
7 232 41 60 00 0	4014586870069	BLK 1.3 TE	535,50	01	129
7 232 42 60 00 0	4014586870137	BLK 1.3 CSE	535,50	01	129
7 234 15 00 23 0	4014586839332	ASte 638	485,10	01	137
7 234 17 00 23 9	4014586841670	ASt 638	437,85	01	137
7 234 22 00 23 0	4014586858470	AStx 649-1	1.832,25	01	140
7 234 23 00 23 0	4014586858500	AStxe 649-1	1.915,20	01	140
7 236 31 50 01 3	4014586859552	FEIN SUPERCUT FSC 1.6	418,95	03	240
7 236 36 50 01 0	4014586863122	FEIN SUPERCUT FSC 2.0 Q	471,45	03	232
7 236 36 51 01 0	4014586862781	FEIN SUPERCUT FSC 2.0 Q for repairing/replacing windows	576,45	03	232
7 236 36 52 01 0	4014586862798	FEIN SUPERCUT FSC 2.0 Q for interior work with wood	576,45	03	232
7 236 36 53 01 0	4014586862804	FEIN SUPERCUT FSC 2.0 Q for tile restoration/bathroom renovation	576,45	03	233
7 236 36 56 01 0	4014586862828	FEIN SUPERCUT FSC 2.0 Q for heating/sanitary installation	576,45	03	233
7 236 38 61 00 0	4014586876351	FEIN SUPERCUT FSC 2.0 X for grout renewal	618,45	03	233
7 236 42 50 01 0	4014586863191	FEIN SUPERCUT FSC 1.6 Q	418,95	03	240
7 236 42 55 01 0	4014586862842	FEIN SUPERCUT FSC 1.6 Q Automotive Workshop	523,95	03	240
7 236 42 56 01 0	4014586862859	FEIN SUPERCUT FSC 1.6 Q Auto Glass	523,95	03	241
7 236 42 57 01 0	4014586862866	FEIN SUPERCUT FSC 1.6 Q Cargo	523,95	03	241
7 238 14 00 23 0	4014586865744	MF 14-180	1.056,30	01	143
7 270 32 00 23 0	4014586862538	KBM 80 auto	3.640,35	01	175
7 270 34 00 23 0	4014586862545	KBM 80 U	3.197,25	01	164
7 270 40 61 00 0	4014586872995	KBM 50 U	1.626,45	01	163
7 270 41 61 00 0	4014586872834	KBM 50 Q	1.447,95	01	163
7 270 42 61 00 0	4014586874272	KBM 50 auto	2.088,45	01	175
7 270 43 61 00 0	4014586872902	KBM 65 U	2.088,45	01	164
7 270 53 61 00 0	4014586886039	KBU 35 Q	1.048,95	01	160
7 270 54 61 00 0	4014586886763	KBU 35 QW	1.048,95	01	160
7 270 55 61 00 0	4014586886053	KBU 35 MQ	1.153,95	01	162
7 270 56 61 00 0	4014586886770	KBU 35 MQW	1.153,95	01	162
7 270 57 61 00 0	4014586886077	KBU 35-2 Q	1.311,45	01	161
7 270 58 61 00 0	4014586886787	KBU 35-2 QW	1.311,45	01	161
7 271 03 61 00 0	4014586876023	KBH 25-2 U	702,45	01	147
7 271 04 61 00 0	4014586876030	KBH 25 S	628,95	01	147
7 272 01 61 00 0	4014586700212	KBB 30	733,95	01	152
7 272 02 61 00 0	4014586700328	KBB 38	890,40	01	152
7 272 03 61 00 0	4014586700502	KBB 40	1.203,30	01	153
7 272 04 61 00 0	4014586700410	KBB 60	1.720,95	01	152
7 534 08 00 00 0	4014586855639	STS 325 R	2.350,95	01	140
7 536 03 00 01 0	4014586861906	FEIN SUPERCUT MOtlx 6-25	594,30	03	241
7 820 02 00 26 8	4014586823874	MSfov 852 300 Hz 200 V	1.328,25	09	-
7 820 43 00 26 5	4014586826646	MSfo 869d 300 Hz 200 V	1.191,75	09	-
7 820 62 00 22 0	4014586856742	MSfo 869-1c 300 Hz 72 V	1.191,75	09	-



Part number	EAN	Description	Price in €	PC	Page
7 820 62 00 26 0	4014586856759	MSfo 869-1c 300 Hz 200 V	1.191,75	09	108
7 820 63 00 12 0	4014586856797	MSfo 869-1c 200 Hz 72 V	1.191,75	09	-
7 820 63 00 17 0	4014586860190	MSfo 869-1c 200 Hz 135 V	1.191,75	09	-
7 820 63 00 20 0	4014586856803	MSfo 869-1c 200 Hz 265 V	1.191,75	09	-
7 820 64 00 12 0	4014586856810	MSfo 869-1d 200 Hz 72 V	1.191,75	09	-
7 820 64 00 17 0	4014586860206	MSfo 869-1d 200 Hz 135 V	1.191,75	09	-
7 820 64 00 20 0	4014586856827	MSfo 869-1d 200 Hz 265 V	1.191,75	09	-
7 820 65 00 22 0	4014586860664	MSfo 869-1d 300 Hz 72 V	1.191,75	09	-
7 820 65 00 26 0	4014586856834	MSfo 869-1d 300 Hz 200 V	1.191,75	09	108
7 820 70 00 20 0	4014586856926	MSfo 852-1c 200 Hz 265 V	1.044,75	09	-
7 820 71 00 26 0	4014586856933	MSfo 852-1c 300 Hz 200 V	1.044,75	09	108
7 820 72 00 20 0	4014586856964	MSfo 852-1d 200 Hz 265 V	1.023,75	09	-
7 820 73 00 26 0	4014586856971	MSfo 852-1d 300 Hz 200 V	1.023,75	09	108
7 820 74 00 12 0	4014586857008	MSfo 870-1c 200 Hz 72 V	1.380,75	09	-
7 820 74 00 17 0	4014586857015	MSfo 870-1c 200 Hz 135 V	1.380,75	09	-
7 820 74 00 20 0	4014586857022	MSfo 870-1c 200 Hz 265 V	1.380,75	09	-
7 820 75 00 26 0	4014586857053	MSfo 870-1c 300 Hz 200 V	1.380,75	09	109
7 820 76 00 20 0	4014586857091	MSfo 870-1d 200 Hz 265 V	1.380,75	09	-
7 820 77 00 26 0	4014586857107	MSfo 870-1d 300 Hz 200 V	1.380,75	09	109
7 820 79 00 20 0	4014586857138	MSfo 849-1c 200 Hz 265 V	1.055,25	09	-
7 820 80 00 26 0	4014586857145	MSfo 849-1c 300 Hz 200 V	1.055,25	09	109
7 820 81 00 17 0	4014586857268	MSf 843-1a 200 Hz 135 V	1.023,75	09	-
7 820 81 00 20 0	4014586857275	MSf 843-1a 200 Hz 265 V	1.023,75	09	-
7 820 81 99 20 0	4014586857282	MSf 843-1a 200 Hz 265 V	1.055,25	09	-
7 820 82 00 12 0	4014586857299	MSfov 852-1 200 Hz 72 V	1.328,25	09	-
7 820 82 00 17 0	4014586857305	MSfov 852-1 200 Hz 135 V	1.328,25	09	-
7 820 82 00 20 0	4014586857312	MSfov 852-1 200 Hz 265 V	1.328,25	09	-
7 820 83 00 22 0	4014586857329	MSfov 852-1 300 Hz 72 V	1.328,25	09	-
7 820 83 00 26 0	4014586857336	MSfov 852-1 300 Hz 200 V	1.328,25	09	109
7 820 85 00 26 0	4014586864402	MSf 843-1c 300 Hz 200 V	966,00	09	110
7 820 86 60 00 0	4014586869513	HFV 9-125 300 Hz 200 V	765,45	09	110
7 820 87 60 00 0	4014586886022	MSfov 852-1-180 300 Hz 200 V	1.569,75	09	110
7 823 03 00 17 2	4014586827575	MSho 840-2 200 Hz 135 V	767,55	09	-
7 823 03 00 20 4	4014586827599	MSho 840-2 200 Hz 265 V	767,55	09	-
7 823 03 00 22 9	4014586827612	MSho 840-2 300 Hz 72 V	767,55	09	-
7 823 03 00 26 0	4014586827636	MSho 840-2 300 Hz 200 V	767,55	09	112
7 823 14 00 17 7	4014586828527	MShyo 840-1 200 Hz 135 V	835,80	09	-
7 823 19 00 20 0	4014586857923	MSh 843-1 200 Hz 265 V	918,75	09	-
7 823 19 00 22 0	4014586857930	MSh 843-1 300 Hz 72 V	918,75	09	-
7 823 19 00 26 0	4014586857947	MSh 843-1 300 Hz 200 V	918,75	09	112
7 823 20 00 12 0	4014586857978	MSho 849-1 Z 200 Hz 72 V	1.055,25	09	-
7 823 20 00 17 0	4014586857985	MSho 849-1z 200 Hz 135 V	1.055,25	09	-
7 823 20 00 20 0	4014586857992	MSho 849-1Z 200 Hz 265 V	1.055,25	09	-
7 823 20 00 22 0	4014586858005	MSho 849-1 Z 300 Hz 72 V	1.055,25	09	-
7 823 20 00 26 0	4014586858012	MSho 849-1 Z 300 Hz 200 V	1.055,25	09	112
7 823 22 00 26 0	4014586860015	MSho 852-1 300 Hz 200 V	1.055,25	09	-
7 824 37 00 22 0	4014586858081	MShyo 869-1a 300 Hz 72 V	1.564,50	09	-
7 824 37 00 26 0	4014586857633	MShyo 869-1a 300 Hz 200 V	1.564,50	09	113
7 824 38 00 26 0	4014586858111	MShyo 869-1d 300 Hz 200 V	1.564,50	09	113
7 824 39 00 12 0	4014586858128	MShyo 852-3a 200 Hz 72 V	1.092,00	09	-
7 824 39 00 17 0	4014586871714	MShyo 852-3a 200 Hz 135 V	1.092,00	09	-
7 824 39 00 20 0	4014586857640	MShyo 852-3a 200 Hz 265 V	1.092,00	09	-
7 824 39 00 22 0	4014586858135	MShyo 852-3a 300 Hz 72 V	1.092,00	09	-
7 824 39 00 26 0	4014586857657	MShyo 852-3a 300 Hz 200 V	1.092,00	09	113
7 824 40 00 26 0	4014586858180	MShyo 852-4a 300 Hz 200 V	1.307,25	09	114
7 824 41 00 20 0	4014586858210	MSho 852-1 200 Hz 265 V	1.048,95	09	-
7 824 42 00 22 0	4014586858234	MSho 852-1 300 Hz 72 V	1.048,95	09	-
7 824 42 00 26 0	4014586858241	MSho 852-1 300 Hz 200 V	1.048,95	09	114
7 901 05 00 40 3	4014586857879	GRIT GXE	767,55	13	254
7 901 21 00 40 3	4014586871844	GX 75	817,95	13	-
7 901 22 00 40 3	4014586871882	GRIT GX 75 2H	1.004,85	13	-
7 901 23 00 44 3	4014586871936	GRIT GXC	1.096,20	13	254
7 901 24 00 44 3	4014586873145	GRIT GXW	603,75	13	254
7 901 31 00 40 3	4014586872018	GRIT GX 75	957,60	13	253
7 901 32 00 40 3	4014586872063	GRIT GX 75 2H	1.143,45	13	253
7 902 01 00 40 3	4014586858913	GRIT GI 75	1.492,05	13	256
7 902 02 00 40 3	4014586858944	GRIT GI 75 2H	1.789,20	13	256
7 902 04 00 40 3	4014586858999	GRIT GI 150	1.802,85	13	256
7 902 05 00 40 3	4014586859019	GRIT GI 150 2H	2.103,15	13	256
7 902 07 00 40 3	4014586859057	GRIT GIE	1.422,75	13	258
7 902 12 00 44 3	4014586867656	GRIT GIC	2.427,60	13	258
7 902 13 00 23 3	4014586872582		2.870,70	13	-
7 902 13 00 40 3	4014586872599	GRIT GIMS 75	2.870,70	13	258
7 902 14 00 23 3	4014586872636		3.099,60	13	-
7 902 14 00 40 3	4014586872643	GRIT GIMS 150	3.099,60	13	258
7 902 16 00 40 3	4014586878614	GIMS 75 2H	3.342,15	13	259

## Machines in numerical order

Part number	EAN	Description	Price in €	PC	Page
7 902 17 00 40 3	4014586878621	GIMS 150 2H	3.565,80	13	259
7 902 18 00 23 3	4014586878638		3.342,15	13	-
7 902 18 00 40 3	4014586878645	GIMS 75-6	3.342,15	13	259
7 902 19 00 23 3	4014586878676		3.565,80	13	-
7 902 19 00 40 3	4014586878683	GIMS 150-6	3.565,80	13	259
7 902 23 00 23 2	4014586887043	GRIT GI 100 EF	1.079,40	13	257
7 902 23 00 40 3	4014586887067	GRIT GI 100	915,60	13	257
7 902 29 00 44 3	4014586878072	GRIT GIS 75	1.187,55	13	-
7 902 29 50 44 3	4014586878126	GRIT GIS 75	1.328,25	13	257
7 902 30 00 23 3	4014586878164		1.457,40	13	-
7 902 30 00 44 3	4014586878171	GIS 150	1.457,40	13	-
7 902 30 50 44 3	4014586878225	GRIT GIS 150	1.598,10	13	257
7 902 35 00 40 3	4014586880921	GRIT GILSGIB	5.040,00	13	259
7 902 48 00 40 3	4014586880945	GRIT GIL	2.427,60	13	260
7 902 51 00 40 3	4014586880976	GRIT GILS	6.245,40	13	260
7 903 01 00 23 2	4014586880426	GRIT GHB 15-50	642,60	01	249
7 903 02 00 23 2	4014586880457	GRIT GHB 15-50 Inox	706,65	01	249
9 03 16 223 00 8	4014586847924	MBS 32 F	2.462,25	01	75
9 03 18 223 00 0	4014586878034	MBS 16 X	927,15	01	74
9 03 19 223 00 0	4014586878041	MBS 25 F	1.309,35	01	74
9 03 20 223 00 0	4014586878515	IBS 16	435,75	01	74
9 08 01 012 00 8	4014586835075	Balancer up to 1,5 kg	64,05	01	270
9 08 01 023 00 1	4014586835099	Balancer up to 2,5 kg	74,55	01	270
9 08 01 024 00 9	4014586835105	Balancer up to 3 kg	170,10	01	270
9 08 01 025 00 3	4014586835136	Balancer up to 5 kg	177,45	01	271
9 08 01 026 00 6	4014586835143	Balancer up to 6,5 kg	192,15	01	271
9 08 01 027 00 0	4014586835150	Balancer up to 9 kg	205,80	01	271
9 08 01 028 00 8	4014586835167	Balancer up to 11 kg	216,30	01	271
9 08 01 029 00 2	4014586835174	Balancer up to 14 kg	223,65	01	272
9 08 01 030 00 4	4014586835181	Balancer up to 17 kg	229,95	01	272
9 08 01 037 00 9	4014586835228	Balancer up to 2,5 kg	79,80	01	270
9 08 01 052 00 4	4014586854052	Balancer up to 1,5 kg	74,55	01	270
9 08 01 055 00 0	4014586880693	Balancer up to 25 kg	649,95	01	272
9 08 01 056 00 0	4014586880709	Balancer up to 32 kg	730,80	01	272
9 08 01 057 00 0	4014586880716	Balancer up to 45 kg	891,45	01	273
9 08 01 058 00 0	4014586880723	Balancer up to 60 kg	1.060,50	01	273
9 20 27 060 00 0	4014586878362	Dustex 25 L set	313,95	01	181
9 20 27 223 00 0	4014586877365	Dustex 25 L	271,95	01	181
9 20 28 060 00 0	4014586878423	Dustex 35 L set	360,15	01	181
9 20 28 223 00 0	4014586877389	Dustex 35 L	316,05	01	182
9 20 29 060 00 0	4014586882956	Dustex 35 LX	480,90	01	182
9 20 30 060 00 0	4014586882994	Dustex 35 LX AC	588,00	01	182
9 20 31 060 00 0	4014586883052	Dustex 35 MX	637,35	01	183
9 20 32 060 00 0	4014586883069	Dustex 35 MX AC	733,95	01	183
9 28 19 340 12 9	4014586845517	MO82-7,5 KSR 50400 200 Hz 72 V	6.686,40	10	-
9 28 19 340 17 6	4014586845524	MO82-7,5 KSR 50400 200 Hz 135 V	6.686,40	10	-
9 28 19 340 20 8	4014586845470	MO82-7,5 KSR 50400 200 Hz 265 V	6.686,40	10	-
9 28 19 340 22 3	4014586845531	MO83-7,5 KSR 50400 300 Hz 72 V	7.516,95	10	-
9 28 19 340 26 4	4014586845494	MO83-7,5KSR 50400 300 Hz 200 V	7.516,95	10	116
9 28 19 361 26 1	4014586837925	MO83-7,5 KSR 60220 300 Hz 200 V	7.516,95	10	-
9 28 21 340 12 5	4014586845548	MO82-11 KSR 50400 200 Hz 72 V	7.116,90	10	-
9 28 21 340 17 2	4014586845555	MO82-11 KSR 50400 200 Hz 135 V	7.116,90	10	-
9 28 21 340 20 4	4014586845562	MO82-11KSR 50400 200 Hz 265 V	7.116,90	10	-
9 28 21 340 22 9	4014586845586	MO83-11 KSR 50400 300 Hz 72 V	8.070,30	10	-
9 28 21 340 26 0	4014586845593	MO83-11KSR 50400 300 Hz 200 V	8.070,30	10	116
9 28 22 328 26 9	4014586838045	MO83-15KSR 50415 300 Hz 200 V	9.770,25	10	-
9 28 22 340 12 9	4014586845616	MO82-15 KSR 50400 200 Hz 72 V	9.489,90	10	-
9 28 22 340 17 6	4014586845623	MO82-15 KSR 50400 200 Hz 135 V	9.489,90	10	-
9 28 22 340 20 8	4014586845630	MO82-15KSR 50400 200 Hz 265 V	9.489,90	10	-
9 28 22 340 22 3	4014586845654	MO83-15 KSR 50400 300 Hz 72 V	9.770,25	10	-
9 28 22 340 26 4	4014586845661	MO83-15KSR 50400 300 Hz 200 V	9.770,25	10	116
9 28 22 345 17 0	4014586867571	MO82-15 KSR 50415 200 Hz 135 V	8.627,85	10	-
9 28 22 373 26 0	4014586865195	MO83-15 KSR 60400 300 Hz 200 V	10.671,15	10	-
9 28 24 340 12 7	4014586845678	MO82-30 KSR 50400 200 Hz 72 V	13.381,20	10	-
9 28 24 340 17 4	4014586845685	MO82-30 KSR 50400 200 Hz 135 V	13.381,20	10	-
9 28 24 340 20 6	4014586845692	MO82-30KSR 50400 200 Hz 265 V	13.381,20	10	-
9 28 24 340 22 1	4014586845708	MO83-30 KSR 50400 300 Hz 72 V	15.244,95	10	-
9 28 24 340 26 2	4014586845715	MO83-30KSR 50400 300 Hz 200 V	15.244,95	10	117
9 28 26 340 12 3	4014586850344	MO82-45 KSR 50400 200 Hz 72 V	16.935,45	10	-
9 28 26 340 17 0	4014586845722	MO82-45 KSR 50400 200 Hz 135 V	16.935,45	10	-
9 28 26 340 20 2	4014586845739	MO82-45KSR 50400 200 Hz 265 V	16.935,45	10	-
9 28 26 340 22 7	4014586850351	MO83-45 KSR 50400 300 Hz 72 V	18.212,25	10	-
9 28 26 340 26 8	4014586845746	MO83-45KSR 50400 300 Hz 200 V	18.212,25	10	117
9 28 28 340 12 1	4014586845753	MO82-20 KSR 50400 200 Hz 72 V	10.017,00	10	-
9 28 28 340 17 8	4014586845760	MO82-20 KSR 50400 200 Hz 135 V	10.017,00	10	-
9 28 28 340 20 0	4014586845777	MO82-20KSR 50400 200 Hz 265 V	10.017,00	10	-



Part number	EAN	Description	Price in €	PC	Page
9 28 28 340 22 5	4014586845784	MO83-20 KSR 50400 300 Hz 72 V	11.179,35	10	-
9 28 28 340 26 6	4014586845791	MO83-20KSR 50400 300 Hz 200 V	11.179,35	10	116
9 28 29 340 12 2	4014586845807	MO82-25 KSR 50400 200 Hz 72 V	12.033,00	10	-
9 28 29 340 17 9	4014586845821	MO82-25 KSR 50400 200 Hz 135 V	12.033,00	10	-
9 28 29 340 20 1	4014586845838	MO82-25KSR 50400 200 Hz 265 V	12.033,00	10	-
9 28 29 340 22 6	4014586845845	MO83-25 KSR 50400 300 Hz 72 V	12.895,05	10	-
9 28 29 340 26 7	4014586845852	MO83-25KSR 50400 300 Hz 200 V	12.926,55	10	117
9 28 29 361 26 4	4014586838427	Frequency converter	12.926,55	10	-
9 90 01 001 00 1	4014586871974	GRIT GXR	1.081,50	13	254
9 90 01 002 00 0	4014586858340	GRIT GIXS	227,85	13	261
9 90 01 003 00 0	4014586859064	GRIT GIB	250,95	13	260
9 90 01 004 00 0	4014586859071	GRIT GIBE	1.429,05	13	260
9 90 01 007 00 1	4014586878263	GRIT GIR	2.064,30	13	261
9 90 01 009 00 0	4014586859125	GRIT GIXBE	1.508,85	13	261
9 90 01 010 00 1	4014586871417	GRIT GISBX	141,75	13	-
9 90 01 012 00 0	4014586880488	GRIT GHBD	214,20	01	250
9 90 01 012 01 0	4014586886992	GRIT GHBM	420,00	01	250
9 90 01 012 02 0	4014586887005	GRIT GHBR	519,75	01	250



**Accessories in numerical order**

Part number	EAN	Description	Price in €	PC	Page
3 01 09 011 00 7	4014586008844	Die	135,52	02	-
3 01 09 106 00 9	4014586009230	Die	205,91	02	-
3 01 09 128 01 8	4014586198071	Adaptor ass.	11,38	04	-
3 01 09 141 00 3	4014586224060	Die	48,70	02	132
3 01 09 141 02 0	4014586318134	Die (2 ea)	77,50	02	132
3 01 09 141 03 0	4014586318141	Die (5 ea)	169,73	02	132
3 01 09 154 00 7	4014586246598	Die holder	192,84	02	132
3 01 09 169 00 9	4014586265056	Die	144,97	02	132
3 01 09 169 03 0	4014586275024	Die/punch set	183,18	02	133
3 01 09 169 04 0	4014586318158	Die (2 ea)	232,46	02	132
3 01 09 170 00 1	4014586265063	Die	164,77	02	133
3 01 09 170 03 0	4014586275031	Die/punch set	200,33	02	132
3 01 09 170 04 0	4014586318165	Die (2 ea)	261,98	02	133
3 01 09 203 00 0	4014586351230	Adaptor key	5,72	02	-
3 02 16 130 00 4	4014586010427	Bolt	0,43	02	-
3 02 17 332 00 9	4014586243672	Centring pin, short	13,73	02	171
3 02 17 333 00 3	4014586243689	Centring pin, long	13,73	02	157
3 02 17 337 00 2	4014586245225	Centring pin, thin	16,47	02	171
3 02 17 338 00 0	4014586251271	Centring pin, thin, short	12,23	02	171
3 02 17 355 00 0	4014586284552	Centering pin	16,47	02	171
3 02 17 358 00 0	4014586341941	Centering pins	13,32	02	157
3 02 17 359 00 0	4014586341958	Centering pins	13,32	02	157
3 02 29 159 00 1	4014586012001	Hand guard	17,44	02	-
3 02 29 216 00 5	4014586012155	Safety guard	5,20	02	200
3 02 29 347 01 0	4014586354330	Metal skewers	4,94	02	59
3 02 31 003 00 3	4014586012414	Chain clamps	49,29	02	-
3 02 31 008 00 0	4014586012421	Chain clamps	119,88	02	-
3 02 31 013 02 7	4014586012483	Chain ass.	166,62	08	-
3 02 31 029 00 2	4014586224183	Roller chain	10,49	08	-
3 02 32 044 01 0	4014586232591	Swivel hook assy	125,88	02	273
3 02 32 046 00 8	4014586259604	Suspension Device	2,34	06	70
3 02 35 007 00 5	4014586012919	Locking pin	2,47	02	-
3 02 35 009 00 7	4014586012926	Locking pin	2,47	02	-
3 02 40 239 01 4	4014586232584	Locking device	66,72	02	273
3 02 40 247 00 2	4014586253510	Bottle holder	14,98	02	-
3 02 40 308 01 0	4014586353111	Vacuum ring set	10,22	02	59
3 05 01 242 00 1	4014586014272	Sleeve	5,74	02	-
3 05 01 345 01 0	4014586272993	Colour-coded ring set, black	14,07	06	34
3 05 01 345 02 0	4014586273006	Coding-sleeve ass.	10,51	06	34
3 05 01 346 01 0	4014586273013	Colour-coded ring set, grey	14,07	06	34
3 05 01 347 01 0	4014586273020	Colour-coded ring set, green	14,07	06	34
3 05 01 348 01 0	4014586273037	Colour-coded ring set, blue	14,07	06	34
3 05 01 349 01 0	4014586273044	Colour-coded ring set, red	14,07	06	34
3 05 01 350 01 0	4014586273051	Colour-coded ring set, orange	14,07	06	34
3 05 01 351 01 0	4014586274898	Colour-coded ring set, yellow	14,07	06	34
3 05 01 352 01 0	4014586317106	Colour-coded ring set, black	14,07	06	34
3 05 01 352 02 0	4014586317113	Coding-sleeve ass.	10,51	06	34
3 05 01 353 01 0	4014586317120	Colour-coded ring set, grey	14,07	06	34
3 05 01 354 01 0	4014586317137	Colour-coded ring set, green	14,07	06	34
3 05 01 355 01 0	4014586317144	Colour-coded ring set, blue	14,07	06	34
3 05 01 356 01 0	4014586317151	Colour-coded ring set, red	14,07	06	34
3 05 01 357 01 0	4014586317168	Colour-coded ring set, orange	14,07	06	34
3 05 01 358 01 0	4014586317175	Colour-coded ring set, yellow	14,07	06	34
3 05 05 066 01 5	4014586235271	Sleeve ass.	30,21	02	-
3 05 05 068 01 7	4014586248769	Sleeve ass.	30,81	02	-
3 05 05 069 01 1	4014586258928	Sleeve ass.	19,88	02	-
3 05 17 028 00 7	4014586016931	Hose nozzle Ø 32 mm	2,49	02	138
3 05 17 029 00 1	4014586016948	Hose nozzle Ø 27 mm	3,02	02	138
3 06 05 109 00 6	4014586224503	adapter	1,16	02	-
3 06 05 110 00 8	4014586224510	adapter	1,16	02	-
3 06 05 114 01 1	4014586266848	Adapter FSC	23,10	04	238
3 07 06 268 00 6	4014586022260	Spiral cordset	70,37	02	-
3 07 07 157 03 5	4014586321035	Spiral cordset	30,14	06	273
3 07 28 123 00 7	4014586030104	Plug 3P+SK	22,71	02	118
3 07 28 124 00 5	4014586030111	Plug 3P+SK	30,88	02	118
3 07 28 130 00 0	4014586030173	Build-on coupler	27,95	02	118
3 07 28 131 00 9	4014586030180	Build-on coupler	36,10	02	118
3 07 28 137 00 5	4014586030241	Wall socket 3P+SK	31,45	02	118
3 07 28 138 00 3	4014586030258	Wall socket 3P+SK	41,93	02	118
3 07 28 141 00 8	4014586030289	Attachment socket 3P+SK EZ28-141	44,26	02	118
3 07 49 065 00 9	4014586031927	Device combination	1.530,90	10	119
3 07 49 067 00 6	4014586031941	Device combination	2.212,35	10	119
3 07 49 068 00 4	4014586031965	Device combination	2.620,80	10	119
3 07 49 069 00 8	4014586031972	Device combination	2.736,30	10	119
3 07 49 070 00 0	4014586031989	Device combination	3.435,60	10	119
3 07 49 073 00 6	4014586032016	Device combination	1.980,30	10	119





Part number	EAN	Description	Price in €	PC	Page
3 07 56 004 00 6	4014586033266	Motor protect switch	25,12	02	-
3 07 56 017 00 6	4014586033358	Motor protect switch	23,71	02	-
3 07 56 085 00 2	4014586264196	Motor safety plug 1.6-2.5 A	175,08	02	118
3 07 56 087 00 9	4014586264219	Motor safety plug 4.0-6.3 A	175,08	02	118
3 07 56 088 00 7	4014586264226	Motor safety plug 6.3-9.0 A	196,76	02	118
3 07 56 089 00 1	4014586264233	Motor protection plug 9.0-12.5 A	196,76	02	118
3 07 56 090 00 3	4014586264240	Motor safety plug 12.5-16.0 A	196,76	02	118
3 07 56 093 00 9	4014586264271	Motor safety plug 1.6-2.5 A	182,31	02	118
3 07 56 095 00 1	4014586264295	Motor safety plug 4.0-6.3 A	182,31	02	118
3 07 56 096 00 4	4014586264301	Motor safety plug 6.3-9.0 A	205,44	02	118
3 07 56 097 00 8	4014586264318	Motor protection plug 9.0-12.5 A	205,44	02	118
3 07 56 098 00 6	4014586264325	Motor safety plug 12.5-16.0 A	205,44	02	118
3 07 98 592 77 0	4014586622040	Cable	7,97	02	-
3 12 07 103 01 3	4014586044910	Eccentric head assy	107,01	06	197
3 12 07 131 02 9	4014586045092	Eccentric head assy	149,79	02	197
3 13 08 072 00 0	4014586048123	1 pair of blades	26,99	02	127
3 13 08 092 00 8	4014586210803	Fixed blade	60,46	02	127
3 13 08 096 00 7	4014586210810	Plunger blade, 4.2 mm	101,30	02	127
3 13 08 098 00 9	4014586213477	Plunger blade, Cr	157,91	02	127
3 13 08 110 00 3	4014586229812	Blades	90,73	02	124
3 13 08 111 00 2	4014586229829	Blade pin	14,43	02	124
3 13 08 113 00 9	4014586229836	Threading dies (set)	96,73	02	124
3 13 08 123 00 8	4014586229867	Cutter blades, up to 2.0 mm	142,58	02	124
3 13 08 136 00 2	4014586229805	Blades	50,67	02	127
3 13 08 143 00 6	4014586230092	Blades	58,29	02	127
3 13 08 146 00 1	4014586232911	Blades	51,38	02	127
3 13 08 147 00 5	4014586232928	Blades	61,32	02	127
3 13 08 150 00 9	4014586239583	Cutter blade, straight, 1 - 1.6 mm	65,26	02	124
3 13 08 151 00 8	4014586239590	Curve blade, 1 mm	69,35	02	124
3 13 08 152 00 1	4014586239606	Blade Cr	78,47	02	124
3 13 08 153 01 4	4014586239613	Threading dies UBS 1.6	70,25	02	124
3 13 08 153 02 0	4014586239620	Threading dies UBS 1.6c	70,25	02	124
3 13 09 036 00 4	4014586048512	Punch	53,48	02	-
3 13 09 039 00 0	4014586048543	Supporting pin	98,68	02	-
3 13 09 040 00 2	4014586048550	Die	51,18	02	132
3 13 09 093 00 3	4014586199931	Die	58,83	02	133
3 13 09 094 00 1	4014586199948	Die	67,00	02	133
3 13 09 097 00 2	4014586199955	Punch	53,38	02	133
3 13 09 098 00 0	4014586199962	Punch	77,75	02	133
3 13 09 100 01 4	4014586199986	Spacer sleeve	92,56	02	-
3 13 09 107 00 0	4014586210742	Die, 5 mm	95,19	02	133
3 13 09 108 00 8	4014586210759	Die, 3 mm	95,19	02	133
3 13 09 109 00 2	4014586210766	P die, 5 mm	95,19	02	133
3 13 09 110 00 4	4014586210773	Punch	77,57	02	133
3 13 09 110 01 3	4014586259161	Punch and die set, 5 mm, steel	168,65	02	133
3 13 09 114 00 8	4014586210780	Chips bag	86,33	02	133
3 13 09 119 00 1	4014586209852	Punch	60,34	02	-
3 13 09 121 00 2	4014586209876	Wearing plate	11,12	02	132
3 13 09 122 00 5	4014586209883	Die	65,50	02	132
3 13 09 122 02 0	4014586318172	Die (2 ea)	118,06	02	132
3 13 09 122 03 0	4014586318189	Die (5 ea)	279,17	02	132
3 13 09 134 00 6	4014586259185	Punch, 3 mm, Cr	77,57	02	133
3 13 09 134 01 5	4014586259192	Punches and dies in a set	168,65	02	133
3 13 22 190 01 4	4014586053363	Filter bag, 5-pack	50,34	02	-
3 13 22 599 01 5	4014586227016	Filter bag, 5-pack	47,10	02	-
3 13 22 600 00 1	4014586227009	Filter element	52,88	02	-
3 13 22 601 01 9	4014586227030	Flat-fold filter	16,39	02	-
3 13 22 602 01 2	4014586227047	Paper filter 5/pack	22,41	02	-
3 13 22 757 01 6	4014586261386	Filter paper BIA, 5-pack	39,18	02	185
3 13 22 765 00 9	4014586261454	Filter cartridge	52,44	02	185
3 13 22 767 01 5	4014586261478	Suction hose assy	45,89	02	185
3 13 22 771 00 9	4014586261492	Connecting piece	4,91	02	138
3 13 22 772 00 2	4014586261508	Stepped collar	9,83	02	185
3 13 22 781 01 7	4014586262451	Paper filter, 5-pack Dustex 25	22,94	02	185
3 13 22 810 01 0	4014586307718	Paper filter, 5-pack Dustex 40	41,79	02	185
3 13 22 811 01 0	4014586307725	Dust bag BIA 5ea Dust40	85,24	02	185
3 13 27 064 00 8	4014586199580	Protective steel jaws	48,83	02	142
3 13 27 068 00 7	4014586199627	Retaining screw	22,09	02	-
3 13 29 100 01 6	4014586218571	Clamping piece, 2-pack	6,20	02	-
3 13 29 106 00 8	4014586218595	Sawing support	12,08	02	-
3 13 29 107 00 2	4014586218588	Sawing support for pipes	53,31	02	-
3 13 33 090 00 0	4014586368375	Drill chuck	29,41	02	-
3 13 33 118 00 0	4014586368382	Drill chuck	25,31	02	-
3 13 35 017 01 1	4014586262390	Rotating roller	67,43	02	194
3 13 45 012 01 0	4014586366197	Flat-fold filter	27,31	02	184
3 13 45 059 01 0	4014586366210	Flat-fold filter	52,48	02	184

**Accessories in numerical order**

Part number	EAN	Description	Price in €	PC	Page
3 13 45 060 01 0	4014586366227	Flat-fold filter	85,25	02	184
3 13 45 061 01 0	4014586366234	Fleece filter bag	21,85	02	185
3 13 45 062 01 0	4014586366241	Fleece filter bag	28,38	02	185
3 13 45 063 01 0	4014586366258	Disposal bag	31,06	02	185
3 13 45 064 01 0	4014586366265	Permanent filter	53,55	02	185
3 13 45 065 01 0	4014586366272	Suction hose	68,54	02	184
3 13 45 066 01 0	4014586366289	Suction hose	56,76	02	184
3 13 45 067 01 0	4014586366296	Extension hose	63,19	02	184
3 13 45 068 01 0	4014586366302	Extension hose	51,41	02	184
3 13 45 069 01 0	4014586366319	Repair set	27,31	02	184
3 13 45 070 01 0	4014586366326	Elbow	11,46	02	184
3 13 45 071 01 0	4014586366333	Suction tube	27,31	02	184
3 13 45 071 02 0	4014586368528	Accessory set	73,90	02	185
3 13 45 072 01 0	4014586366340	Floor nozzle	34,91	02	184
3 13 45 073 01 0	4014586366357	Combination nozzle	32,77	02	184
3 13 45 074 01 0	4014586366364	Crevice nozzle	5,46	02	184
3 13 45 075 01 0	4014586366371	Upholstery nozzle	8,24	02	184
3 13 45 076 01 0	4014586366388	Suction brush,	10,38	02	184
3 13 45 077 01 0	4014586366395	Intake brush	16,39	02	184
3 13 45 079 01 0	4014586366418	Stepped collar	10,38	02	184
3 13 45 119 01 0	4014586370187	Cable holder	6,43	02	184
3 13 45 120 01 0	4014586386119	Suction hose	159,58	02	184
3 13 45 121 01 0	4014586392059	Suction hose	138,16	02	184
3 13 45 123 01 0	4014586378596	Tool collar with suction force regulation	26,78	02	184
3 13 45 130 01 0	4014586379449	HEPA filter bag	94,25	02	185
3 13 45 133 02 0	4014586386126	Accessory set	77,11	02	185
3 13 45 137 01 0	4014586386133	Aluminium combi nozzle	101,75	02	184
3 13 45 250 01 0	4014586392066	Tool collar with suction force regulation	24,58	02	184
3 13 45 251 01 0	4014586392691	Premium fleece filter bag	45,79	02	185
3 13 45 263 01 0	4014586394459	Elbow	17,03	02	184
3 14 14 024 01 0	4014586060187	Suction hose assy	76,92	02	-
3 14 14 054 00 8	4014586208916	Hose	3,14	02	157
3 14 14 055 00 2	4014586227290	Hose, ass.	62,46	08	-
3 14 14 055 01 1	4014586252421	Hose ass.	1.330,68	08	-
3 14 14 059 01 0	4014586227108	Suction hose	45,89	02	-
3 14 14 070 01 0	4014586356433	Flex-jointed hose	12,62	02	157
3 14 15 020 00 8	4014586060392	Anti vibration mounts	35,64	02	119
3 14 15 081 00 1	4014586207865	Anti vibration mounts	15,50	02	119
3 14 20 120 01 0	4014586376677	Protection for AccuTEC ASM	19,95	02	34
3 14 20 131 01 0	4014586396408	BOP 10 protective cap	11,68	02	70
3 14 20 132 01 0	4014586396415	BOP 10-2 protective cap	11,68	02	70
3 14 26 030 00 5	4014586061641	Velcro fastener	15,77	02	197
3 14 26 067 01 6	4014586236797	Anti-slip mat	18,90	02	59
3 14 28 102 01 6	4014586195957	Anti-chipping protection, 5-pack	9,16	02	138
3 14 28 156 00 0	4014586272047	Plastic cover	7,33	02	-
3 14 28 166 00 0	4014586305134	Protective layer	6,30	02	35
3 18 01 010 01 2	4014586069210	Support	84,92	02	-
3 18 10 070 01 6	4014586069678	Protective cover assy	31,00	02	-
3 18 10 071 01 5	4014586069739	Protective cover assy	37,87	02	-
3 18 10 171 00 5	4014586070124	Suction hood	195,68	02	-
3 18 10 240 01 4	4014586228945	Suction hood	20,87	06	197
3 18 10 247 01 9	4014586241906	Chipping protector	18,42	02	-
3 18 10 263 00 0	4014586325484	Contact guard	4,41	04	-
3 18 10 264 01 0	4014586307343	Protect.suction hood	18,64	02	197
3 18 10 277 00 0	4014586326238	Wheel guard	10,91	02	-
3 18 10 299 00 0	4014586394107	Wheel guard	8,07	06	94
3 18 10 300 00 0	4014586394114	Wheel guard	8,39	06	195
3 18 10 301 00 0	4014586394121	Wheel guard	8,51	06	94
3 18 10 305 00 0	4014586407852	Wheel guard	30,45	02	-
3 21 09 061 01 6	4014586074542	Clamping chuck assy	77,73	02	-
3 21 19 032 00 2	4014586074689	Side handle	6,21	02	-
3 21 19 047 00 4	4014586074801	Handle	10,33	02	-
3 21 19 058 00 1	4014586074849	Handle	12,64	02	-
3 21 19 078 02 4	4014586074962	Handle ass.	22,30	02	-
3 21 19 103 01 7	4014586215587	Handle ass.	28,28	02	-
3 21 19 107 01 6	4014586222882	Handle ass.	4,89	02	-
3 21 19 113 01 6	4014586235264	Handle ass.	14,05	02	-
3 21 19 116 01 1	4014586267616	Bail handle	42,67	04	238
3 21 19 117 01 5	4014586268125	anti-vibration handle	34,09	02	118
3 21 19 118 01 3	4014586268132	anti-vibration handle	34,09	02	118
3 21 19 119 01 7	4014586268149	anti-vibration handle	34,09	02	-
3 21 19 124 01 0	4014586334783	anti-vibration handle	8,48	02	118
3 21 19 127 03 0	4014586351971	Starter awl	21,58	02	59
3 21 19 148 02 0	4014586404790	Additional handle	41,01	04	229
3 21 19 150 01 0	4014586404523	Handle	41,90	02	35
3 21 20 025 00 6	4014586075105	Extension for tube handle	28,40	02	-



Part number	EAN	Description	Price in €	PC	Page
3 21 23 002 00 6	4014586270906	Adjustment spanner - torque	7,98	02	34
3 21 25 043 00 4	4014586075341	Bow	6,89	02	-
3 21 25 050 00 7	4014586075396	Suspension Device	9,70	02	56
3 21 27 003 03 5	4014586075594	Depth stop	78,99	02	-
3 21 27 005 00 6	4014586075600	Depth stop	5,45	02	56
3 21 27 005 02 1	4014586075617	Depth stop	34,89	02	-
3 21 27 021 03 6	4014586075761	Stop sleeve	25,60	02	-
3 21 27 021 06 1	4014586075792	Stop sleeve	56,84	02	-
3 21 27 021 10 4	4014586250717	Stop sleeve	49,21	02	-
3 21 27 021 11 3	4014586250724	Stop sleeve	24,51	02	-
3 21 27 021 12 9	4014586258669	Stop sleeve	19,47	02	-
3 21 27 021 13 5	4014586262406	Stop sleeve	15,45	02	-
3 21 27 021 14 1	4014586270531	Depth stop assy	41,71	02	-
3 21 27 021 15 0	4014586295343	Stop sleeve	21,30	02	-
3 21 27 043 00 0	4014586075983	Stop sleeve	15,72	02	-
3 21 27 057 00 8	4014586208831	Stop sleeve	16,89	02	-
3 21 27 059 00 0	4014586215594	Depth stop	9,69	02	-
3 21 27 065 01 9	4014586266077	Depth stop assy	35,13	02	-
3 21 27 069 01 0	4014586351674	Depth stop	18,52	04	219
3 21 32 020 12 9	4014586076706	Cutting paste	14,11	04	124
3 21 32 022 00 7	4014586076713	Pump	9,59	02	157
3 21 32 031 00 0	4014586289922	High-performance cutting oil spray	15,20	02	150
3 21 33 012 01 8	4014586076775	Feed screw	112,78	02	-
3 21 33 021 01 0	4014586404745	Device for dust extract	62,72	04	229
3 21 73 003 00 3	4014586265568	Work gloves, small, pair	72,18	04	195
3 21 73 004 00 1	4014586265575	Work gloves, mid-size, pair	72,18	04	195
3 21 73 005 00 5	4014586265582	Work gloves, large, pair	72,18	04	195
3 21 74 003 00 0	4014586077215	Protective cage	10,33	02	-
3 21 74 006 00 5	4014586199641	Ratchet buckle w/ strap	138,83	02	-
3 21 74 007 00 9	4014586214740	Ratchet buckle w/ strap	16,58	02	-
3 21 74 008 00 7	4014586241890	Strap, safety	16,01	02	-
3 21 74 011 00 0	4014586319056	Protective cover	6,31	04	242
3 21 74 013 01 0	4014586335773	Swarf cup	17,52	02	150
3 21 74 013 10 0	4014586353128	Protective cover	15,50	02	59
3 21 74 013 20 0	4014586353135	Protective cover	18,94	02	59
3 21 74 014 01 0	4014586376691	AccuTec ASW protective cover	16,80	02	34
3 21 74 015 01 0	4014586376707	Battery cover	16,80	02	34
3 21 74 016 01 0	4014586376714	Battery cover	17,85	02	34
3 21 74 019 01 0	4014586404905	Battery cover	19,95	02	34
3 21 74 020 01 0	4014586404912	Battery cover	18,90	02	34
3 21 74 021 01 0	4014586404929	Protective layer	12,50	02	35
3 21 74 022 01 0	4014586404936	Protective layer	12,50	02	35
3 21 74 024 01 0	4014586404943	AccuTec ASW protective cover	26,25	02	34
3 24 22 326 01 0	4014586369846	Adapter plate for magnetic core drills	42,61	02	75
3 24 33 027 01 7	4014586210469	Plate ass.	88,87	08	-
3 26 23 009 00 6	4014586200699	Reducing rings	32,77	02	75
3 26 23 010 00 8	4014586200422	Reducing rings	32,77	02	75
3 26 23 012 01 9	4014586248776	Reducing rings	32,77	02	75
3 26 23 013 00 4	4014586248783	Reducing rings	32,77	02	75
3 26 23 014 01 0	4014586369853	Reducing rings	32,77	02	75
3 27 14 037 01 3	4014586091938	Clip assy	246,26	02	-
3 27 14 062 02 3	4014586092133	Hands-free support	200,55	02	142
3 27 14 071 01 3	4014586092201	Clamping jaw assy	37,17	02	-
3 27 14 084 00 8	4014586195872	Shoe plate	90,91	02	138
3 27 14 088 00 7	4014586200750	Chipping protector	4,54	02	138
3 27 15 051 03 8	4014586092812	Extension chain	839,18	08	-
3 39 01 021 01 1	4014586110165	Tool case	52,00	02	94
3 39 01 022 01 4	4014586110202	Tool case	47,78	02	142
3 39 01 031 00 1	4014586110233	Tool case	71,40	08	-
3 39 01 032 01 3	4014586110257	Tool case	49,27	02	71
3 39 01 045 01 8	4014586110387	Tool case	40,56	02	-
3 39 01 073 01 3	4014586200002	Tool case	163,02	02	-
3 39 01 096 01 6	4014586242095	Tool case	182,31	02	-
3 39 01 100 02 0	4014586287980	Tool case assy for core drill	18,27	02	-
3 39 01 112 02 0	4014586317939	Tool case	84,29	04	-
3 39 01 114 00 7	4014586266732	Metal case	900,95	08	-
3 39 01 118 01 0	4014586285474	Tool case	37,26	02	105
3 39 01 118 20 0	4014586302775	tool case - FSC	46,63	04	-
3 39 01 118 48 0	4014586317618	Tool case	48,95	02	70
3 39 01 118 93 0	4014586334974	Carrying case unfilled	45,71	04	-
3 39 01 119 00 0	4014586285498	Plastic box	3,97	02	105
3 39 01 121 02 0	4014586317946	Tool box ass.	190,63	02	-
3 39 01 122 01 0	4014586308791	Tool case	63,36	02	201
3 39 01 122 06 0	4014586321165	Tool case	72,58	02	-
3 39 01 122 12 0	4014586336732	Tool case	71,49	02	-
3 39 01 126 02 0	4014586332406	Tool box ass.	83,61	02	-

Part number	EAN	Description	Price in €	PC	Page
3 39 01 127 02 0	4014586325859	Tool box ass.	84,85	02	-
3 39 01 128 58 0	4014586367897	Tool case	45,62	02	-
3 39 01 128 82 0	4014586349435	Tool case	46,06	02	-
3 39 01 130 05 0	4014586333250	Tool case	73,91	02	-
3 39 01 131 03 0	4014586348957	Tool case	46,99	02	-
3 39 01 131 08 0	4014586348650	Tool case	46,99	02	56
3 39 01 131 92 0	4014586376325	Tool case	42,46	02	-
3 39 01 131 94 0	4014586379630	Tool case	44,73	02	56
3 39 01 131 98 0	4014586376332	Carrying case unfilled	41,63	04	227
3 39 01 132 03 0	4014586340449	Tool box ass.	83,61	02	-
3 39 01 133 05 0	4014586351247	Tool case	73,91	02	-
3 39 01 134 04 0	4014586340456	Tool box ass.	84,85	02	-
3 39 01 140 99 0	4014586356310	Tool case	85,05	02	-
3 39 01 141 01 0	4014586365244	Plastic tool cases	22,58	02	-
3 39 01 142 14 0	4014586356921	Tool box ass.	84,85	02	-
3 39 01 143 06 0	4014586356938	Tool box ass.	84,85	02	-
3 39 01 144 01 0	4014586356945	Carrying case unfilled	22,18	02	227
3 39 01 146 00 0	4014586380025	Systainer Sys 1	51,24	02	227
3 39 01 147 00 0	4014586380032	Systainer Sys 2	55,61	02	47
3 39 01 152 05 0	4014586407654	Tool case	52,40	04	-
3 39 01 153 01 0	4014586398402	Tool case	22,58	04	-
3 39 01 154 05 0	4014586403786	Tool case	41,63	04	-
3 39 01 155 02 0	4014586379647	Tool box ass.	186,89	02	-
3 39 01 160 01 0	4014586394091	Tool case	22,13	02	14
3 39 04 491 00 0	4014586382999	Systainer insert for FMM 350 Q / QSL	8,77	06	227
3 39 98 140 02 2	4014586622231	Tool case	75,38	02	-
3 39 98 140 08 2	4014586662039	Tool case	75,38	02	-
3 43 00 000 00 1	4014586402796	Contact guard	4,33	04	219
3 52 22 927 05 0	4014586392455	Adapter for FEIN oscillator (up to 2004)	10,61	04	227
3 52 22 942 04 0	4014586392462	Best of Sanding accessory set	61,95	04	222
3 52 22 942 05 0	4014586392479	Best of E-Cut accessory set	61,95	04	219
3 52 22 942 06 0	4014586392486	Best of Renovation accessory set	166,95	04	222
3 52 22 942 07 0	4014586392677	Best of Tileworking accessory set	86,30	04	225
3 52 22 942 13 0	4014586397436	Best of E-Cut accessory set	96,99	04	-
3 52 22 946 01 0	4014586397443	Accessory set for interior construction work with wood	170,22	04	230
3 52 22 946 02 0	4014586397450	Accessory set for repairing/replacing windows	170,22	04	230
3 52 22 946 03 0	4014586397467	Accessory set for tile restoration/bathroom renovation	170,22	04	230
3 52 22 946 04 0	4014586397474	Accessory set for heating/sanitary installation	170,22	04	230
3 52 22 946 06 0	4014586397498	Composite set of accessories	170,22	04	-
3 52 22 952 01 0	4014586392516	HSS saw blade With depth stop	64,81	04	219
3 52 22 952 02 0	4014586392523	Saw and file set FMM SLP	25,70	04	226
3 52 22 952 03 0	4014586392530	E-Cut-Combo SLP	41,90	04	219
3 52 22 952 04 0	4014586392547	Adapter FSC	13,82	04	238
3 52 22 952 05 0	4014586392554	Adapter FSC Qi	13,82	04	238
3 52 22 952 10 0	4014586404721	Set of sanding sheets	10,40	04	224
3 52 22 952 11 0	4014586404479	Sanding sheet set, zirconium	17,75	04	224
3 52 22 952 12 0	4014586398426	Best of Tileworking accessory set	32,03	04	-
3 52 22 952 13 0	4014586400389	E-Cut-Combo	41,90	04	-
3 90 00 000 00 1	4014586280028	Graphite 80 x 430 mm (5-pack)	77,69	06	264
3 90 00 000 00 2	4014586280035	Flexible hose Ø 90, 1.0 m	40,98	06	265
3 90 00 000 00 3	4014586280042	Clamping band Ø 90	5,49	06	265
3 90 00 000 00 4	4014586280059	Eye protection 75, triple pack	34,94	06	264
3 90 00 000 00 7	4014586280080	Eye protection GU75/GR/GXR (3 pieces)	56,21	06	264
3 90 00 000 05 6	4014586283517	Graphite 155 x 430 mm, 3-pack	89,34	06	266
3 90 00 000 18 4	4014586283494	Eye protection 150, GU150 3-pack	67,22	06	266
3 90 00 000 49 6	4014586280325	Brassglide support	39,90	06	265
3 90 00 000 49 7	4014586280332	Nylon glide support	42,27	06	265
3 90 00 000 97 6	4014586286303	Filter for GIBE, 523 x 241	111,65	06	266
3 90 00 001 10 1	4014586302638	Metal filter for GIXBE, packed	112,78	06	266
3 90 00 001 32 0	4014586294407	Chamfering unit old grit classic GZ	169,05	13	-
3 90 00 001 51 7	4014586297361	angle support for GF75	123,90	13	-
3 90 00 004 55 4	4014586330686	Drilling template	19,20	06	267
3 90 00 004 76 0	4014586380933	Graphite pad	15,45	06	267
3 90 00 008 10 6	4014586389837	Stainless steel sanding support	67,47	02	251
4 06 11 009 01 9	4014586126760	Sealing ring set	8,69	02	-
4 11 40 004 00 7	4014586128399	Hose coupling	25,49	02	142
4 30 33 087 06 5	4014586225173	Set of clamping screws	7,93	04	-
6 01 10 008 01 7	4014586165790	Tool holder Ø 7 mm with external flat	23,96	02	-
6 05 03 306 00 8	4014586262772	Bit, 1/4" hexagon head	7,43	02	19
6 05 05 015 00 1	4014586258713	Insert, 1/4" hexagon head, SW 8	13,95	02	-
6 05 10 011 00 9	4014586235141	Tool holder 1/4" external hexagon	18,17	02	14
6 05 10 215 00 3	4014586258812	Tool holder 1/4" external hexagon	22,52	02	18
6 05 10 219 01 0	4014586367910	Bit holder	23,40	02	-
6 05 10 222 01 0	4014586404820	Bit holder	31,06	02	15
6 22 19 002 07 9	4014586168012	Socket for stay bolts	133,55	02	-
6 22 19 002 09 1	4014586168036	Socket for stay bolts	111,86	02	-



Part number	EAN	Description	Price in €	PC	Page
6 22 19 002 10 6	4014586168043	Socket for stay bolts	111,86	02	-
6 22 19 002 14 3	4014586168074	Socket for stay bolts	111,86	02	-
6 27 12 109 03 4	4014586169637	Bit, 1/4" hexagon head, 5-pack	7,96	02	18
6 29 01 002 00 4	4014586172071	Jaw spanner SW8	5,57	02	-
6 29 01 003 00 8	4014586172088	Jaw spanner SW9	5,57	02	-
6 29 01 007 00 7	4014586172125	Jaw spanner SW13	5,57	02	-
6 29 01 016 00 2	4014586172217	Jaw spanner SW46	15,67	02	-
6 29 03 002 00 9	4014586172255	Jaw spanner SW17	5,57	02	56
6 29 03 010 00 6	4014586172309	Single head wrench	26,32	08	-
6 29 03 011 00 5	4014586172316	Jaw spanner SW17	3,43	02	-
6 29 04 003 00 0	4014586172347	Jaw spanner 19 x 22	5,57	02	-
6 29 06 009 00 7	4014586172415	Socket spanner SW 8	3,12	02	-
6 29 06 013 00 5	4014586226101	Socket spanner SW46	40,93	02	-
6 29 07 004 00 5	4014586172446	Allen key SW6	1,61	02	-
6 29 07 006 00 2	4014586172453	Allen key SW8	1,61	02	-
6 29 07 010 00 0	4014586172477	Allen key SW4	1,61	02	-
6 29 07 011 00 9	4014586172484	Allen key SW5	1,61	02	-
6 29 07 013 00 6	4014586172491	Allen key SW3	1,61	02	-
6 29 07 015 00 8	4014586172514	Allen key SW2.5	1,61	02	-
6 29 07 017 00 5	4014586172521	Allen key SW4.5	5,74	02	-
6 29 07 023 00 5	4014586172545	Socket head wrench	1,61	02	-
6 29 07 029 00 6	4014586172590	Allen key SW2	1,61	02	-
6 29 07 030 00 8	4014586172606	Allen key SW8	3,43	02	-
6 29 07 034 00 2	4014586218618	Socket spanner SW4	1,61	02	-
6 29 07 037 00 3	4014586249728	Allen key	1,98	02	-
6 29 08 013 00 3	4014586172675	Sickle spanner	21,30	02	-
6 29 10 007 00 7	4014586172705	Bidirectional nut spanner	17,22	02	-
6 29 10 022 00 2	4014586172736	Bidirectional nut spanner	3,43	02	-
6 29 10 023 00 6	4014586172743	Bidirectional nut spanner	3,43	02	-
6 29 10 031 00 8	4014586172811	Bi-directional nut spanner	9,03	04	-
6 29 11 004 00 5	4014586172828	Ring spanner SW32	4,39	02	-
6 29 11 010 00 0	4014586220772	Ring spanner 17 x 19	17,33	08	-
6 29 12 001 00 4	4014586266107	Screwdriver	13,35	02	-
6 29 13 004 00 0	4014586172859	Retaining pin	3,60	02	-
6 29 13 020 00 4	4014586172927	Retaining pin	1,14	02	-
6 29 13 021 00 3	4014586208688	Retaining pin	3,05	02	-
6 29 14 001 00 2	4014586172934	Chuck key	4,35	02	-
6 29 14 002 00 5	4014586172941	Chuck key	2,08	02	-
6 29 14 004 00 7	4014586172958	Chuck key	4,04	02	-
6 29 14 005 00 1	4014586172965	Chuck key	10,91	02	-
6 29 14 011 00 1	4014586173016	Chuck key	6,49	02	-
6 31 06 016 01 0	4014586271767	Extension 100 mm QI	73,07	02	171
6 31 06 017 01 0	4014586335063	Extension QIP 100 mm	70,94	02	150
6 31 11 009 01 0	4014586326597	Twist drill D10 HSS QI	18,90	02	171
6 31 11 010 01 0	4014586326603	Twist drill D10.2 HSS QI	18,90	02	171
6 31 11 011 01 0	4014586326610	Twist drill D11 HSS QI	21,53	02	171
6 31 11 012 01 0	4014586326627	Twist drill D12 HSS QI	21,53	02	171
6 31 11 013 01 0	4014586326634	Twist drill D13 HSS QI	23,10	02	171
6 31 11 014 01 0	4014586326641	Twist drill D14 HSS QI	23,10	02	171
6 31 11 015 01 0	4014586326658	Twist drill D15 HSS QI	24,15	02	171
6 31 11 016 01 0	4014586326665	Twist drill D15.5 HSS QI	24,15	02	171
6 31 14 038 01 0	4014586331027	Centring drill bit	14,54	02	149
6 31 14 038 02 0	4014586332796	Centring drill long pack of 5	65,43	02	149
6 31 27 001 01 5	4014586176130	HM Ultra50 core drill Ø 18 M18 x 6 P 1,5	50,84	20	165
6 31 27 002 01 8	4014586176147	HM Ultra50 core drill Ø 20 M18 x 6 P 1,5	50,84	20	165
6 31 27 003 01 2	4014586176154	HM Ultra50 core drill Ø 22 M18 x 6 P 1,5	50,84	20	166
6 31 27 004 01 0	4014586176161	HM Ultra50 core drill Ø 25 M18 x 6 P 1,5	50,84	20	166
6 31 27 005 01 4	4014586176178	HM Ultra50 core drill Ø 26 M18 x 6 P 1,5	50,84	20	166
6 31 27 006 01 7	4014586176185	HM Ultra50 core drill Ø 28 M18 x 6 P 1,5	50,84	20	166
6 31 27 007 01 1	4014586176192	HM Ultra50 core drill Ø 30 M18 x 6 P 1,5	50,84	20	166
6 31 27 008 01 9	4014586176208	HM Ultra50 core drill Ø 32 M18 x 6 P 1,5	56,83	20	166
6 31 27 009 01 3	4014586176215	HM Ultra50 core drill Ø 34 M18 x 6 P 1,5	56,83	20	166
6 31 27 010 01 5	4014586176222	HM Ultra50 core drill Ø 35 M18 x 6 P 1,5	56,83	20	166
6 31 27 011 01 4	4014586176239	HM Ultra50 core drill Ø 38 M18 x 6 P 1,5	65,79	20	166
6 31 27 012 01 7	4014586176246	HM Ultra50 core drill Ø 40 M18 x 6 P 1,5	65,79	20	166
6 31 27 013 01 1	4014586176253	HM Ultra50 core drill Ø 42 M18 x 6 P 1,5	77,70	20	166
6 31 27 014 01 9	4014586176260	HM Ultra50 core drill Ø 43 M18 x 6 P 1,5	77,70	20	166
6 31 27 015 01 3	4014586176277	HM Ultra50 core drill Ø 45 M18 x 6 P 1,5	77,70	20	166
6 31 27 016 01 6	4014586176284	HM Ultra50 core drill Ø 48 M18 x 6 P 1,5	86,76	20	166
6 31 27 017 01 0	4014586176291	HM Ultra50 core drill Ø 50 M18 x 6 P 1,5	86,76	20	166
6 31 27 018 01 8	4014586176307	HM Ultra50 core drill Ø 52 M18 x 6 P 1,5	95,87	20	166
6 31 27 019 01 2	4014586176314	HM Ultra50 core drill Ø 19 M18 x 6 P 1,5	50,84	20	165
6 31 27 020 01 4	4014586176321	HM Ultra50 core drill Ø 21 M18 x 6 P 1,5	50,84	20	166
6 31 27 021 01 3	4014586176338	HM Ultra50 core drill Ø 23 M18 x 6 P 1,5	50,84	20	166
6 31 27 022 01 6	4014586176345	HM Ultra50 core drill Ø 24 M18 x 6 P 1,5	50,84	20	166
6 31 27 023 01 0	4014586176352	HM Ultra50 core drill Ø 27 M18 x 6 P 1,5	50,84	20	166



Accessories in numerical order

Part number	EAN	Description	Price in €	PC	Page
6 31 27 024 01 8	4014586176369	HM Ultra50 core drill Ø 29 M18 x 6 P 1,5	50,84	20	166
6 31 27 025 01 2	4014586176376	HM Ultra50 core drill Ø 31 M18 x 6 P 1,5	56,83	20	166
6 31 27 026 01 5	4014586176383	HM Ultra50 core drill Ø 33 M18 x 6 P 1,5	56,83	20	166
6 31 27 027 01 9	4014586176390	HM Ultra50 core drill Ø 36 M18 x 6 P 1,5	65,79	20	166
6 31 27 028 01 7	4014586176406	HM Ultra50 core drill Ø 37 M18 x 6 P 1,5	65,79	20	166
6 31 27 029 01 1	4014586176413	HM Ultra50 core drill Ø 39 M18 x 6 P 1,5	65,79	20	166
6 31 27 030 01 3	4014586176420	HM Ultra50 core drill Ø 41 M18 x 6 P 1,5	77,70	20	166
6 31 27 031 01 2	4014586176437	HM Ultra50 core drill Ø 44 M18 x 6 P 1,5	77,70	20	166
6 31 27 032 01 5	4014586176444	HM Ultra50 core drill Ø 46 M18 x 6 P 1,5	86,76	20	166
6 31 27 033 01 9	4014586176451	HM Ultra50 core drill Ø 47 M18 x 6 P 1,5	86,76	20	166
6 31 27 034 01 7	4014586176468	HM Ultra50 core drill Ø 49 M18 x 6 P 1,5	86,76	20	166
6 31 27 035 01 1	4014586176475	HM Ultra50 core drill Ø 51 M18 x 6 P 1,5	95,87	20	166
6 31 27 036 01 4	4014586192369	HM Ultra50 core drill Ø 53 M18 x 6 P 1,5	95,87	20	166
6 31 27 037 01 8	4014586192376	HM Ultra50 core drill Ø 54 M18 x 6 P 1,5	95,87	20	166
6 31 27 038 01 6	4014586192383	HM Ultra50 core drill Ø 55 M18 x 6 P 1,5	95,87	20	166
6 31 27 039 01 0	4014586192390	HM Ultra50 core drill Ø 56 M18 x 6 P 1,5	99,92	20	166
6 31 27 040 01 2	4014586192406	HM Ultra50 core drill Ø 57 M18 x 6 P 1,5	99,92	20	166
6 31 27 041 01 1	4014586192413	HM Ultra50 core drill Ø 58 M18 x 6 P 1,5	99,92	20	166
6 31 27 042 01 4	4014586200941	HM Ultra50 core drill Ø 12 M18 x 6 P 1,5	50,84	20	165
6 31 27 043 01 8	4014586200958	HM Ultra50 core drill Ø 13 M18 x 6 P 1,5	50,84	20	165
6 31 27 044 01 6	4014586200965	HM Ultra50 core drill Ø 14 M18 x 6 P 1,5	50,84	20	165
6 31 27 045 01 0	4014586200972	HM Ultra50 core drill Ø 15 M18 x 6 P 1,5	50,84	20	165
6 31 27 046 01 3	4014586200989	HM Ultra50 core drill Ø 16 M18 x 6 P 1,5	50,84	20	165
6 31 27 047 01 7	4014586200996	HM Ultra50 core drill Ø 17 M18 x 6 P 1,5	50,84	20	165
6 31 27 049 01 9	4014586223179	HM Ultra50 core drill Ø 59 M18 x 6 P 1,5	101,39	20	166
6 31 27 050 01 1	4014586223186	HM Ultra50 core drill Ø 60 M18 x 6 P 1,5	101,39	20	166
6 31 27 051 01 0	4014586223193	HM Ultra50 core drill Ø 61 M18 x 6 P 1,5	114,73	20	166
6 31 27 052 01 3	4014586223209	HM Ultra50 core drill Ø 62 M18 x 6 P 1,5	114,73	20	166
6 31 27 053 01 7	4014586223216	HM Ultra50 core drill Ø 63 M18 x 6 P 1,5	114,73	20	166
6 31 27 054 01 5	4014586223223	HM Ultra50 core drill Ø 64 M18 x 6 P 1,5	114,73	20	166
6 31 27 055 01 9	4014586223230	HM Ultra50 core drill Ø 65 M18 x 6 P 1,5	114,73	20	166
6 31 27 061 01 9	4014586229447	Core drill Ø 90	246,76	20	-
6 31 27 086 01 9	4014586239996	HM Ultra core drill Ø 12/35 HM QI	47,11	20	165
6 31 27 086 04 0	4014586375533	Best of core bits HM Ultra 35 QI 12,14,16,18,20,22 mm accessory set	221,74	20	165
6 31 27 087 01 3	4014586240008	HM Ultra-core drill Ø 13/35 HM QI	47,11	20	165
6 31 27 088 01 1	4014586240015	HM Ultra-core drill Ø 14/35 HM QI	47,11	20	165
6 31 27 089 01 5	4014586240022	HM Ultra-core drill Ø 15/35 HM QI	47,11	20	165
6 31 27 090 01 7	4014586240039	HM Ultra-core drill Ø 16/35 HM QI	47,11	20	165
6 31 27 091 01 6	4014586240046	HM Ultra-core drill Ø 17/35 HM QI	47,11	20	165
6 31 27 092 01 9	4014586240053	HM Ultra-core drill Ø 18/35 HM QI	47,11	20	165
6 31 27 093 01 3	4014586240060	HM Ultra-core drill Ø 19/35 HM QI	47,11	20	165
6 31 27 094 01 1	4014586240077	HM Ultra-core drill Ø 20/35 HM QI	47,11	20	165
6 31 27 095 01 5	4014586240084	HM Ultra-core drill Ø 21/35 HM QI	47,11	20	165
6 31 27 096 01 8	4014586240091	HM Ultra-core drill Ø 22/35 HM QI	47,11	20	165
6 31 27 097 01 2	4014586240107	HM Ultra-core drill Ø 23/35 HM QI	47,11	20	165
6 31 27 098 01 0	4014586240114	HM Ultra-core drill Ø 24/35 HM QI	47,11	20	165
6 31 27 099 01 4	4014586240121	HM Ultra-core drill Ø 25/35 HM QI	47,11	20	165
6 31 27 100 01 5	4014586240138	HM Ultra-core drill Ø 26/35 HM QI	47,11	20	165
6 31 27 101 01 4	4014586240145	HM Ultra-core drill Ø 27/35 HM QI	47,11	20	165
6 31 27 102 01 7	4014586240152	HM Ultra-core drill Ø 28/35 HM QI	47,11	20	165
6 31 27 103 01 1	4014586240169	HM Ultra-core drill Ø 29/35 HM QI	54,21	20	165
6 31 27 104 01 9	4014586240176	HM Ultra-core drill Ø 30/35 HM QI	54,21	20	165
6 31 27 105 01 3	4014586240183	HM Ultra-core drill Ø 31/35 HM QI	54,21	20	165
6 31 27 106 01 6	4014586240190	HM Ultra-core drill Ø 32/35 HM QI	54,21	20	165
6 31 27 107 01 0	4014586240206	HM Ultra-core drill Ø 33/35 HM QI	54,21	20	165
6 31 27 108 01 8	4014586240213	HM Ultra-core drill Ø 34/35 HM QI	54,21	20	165
6 31 27 109 01 2	4014586240220	HM Ultra-core drill Ø 35/35 HM QI	54,21	20	165
6 31 27 110 01 4	4014586240237	HM Ultra-core drill Ø 36/35 HM QI	62,77	20	165
6 31 27 111 01 3	4014586240244	HM Ultra-core drill Ø 37/35 HM QI	62,77	20	165
6 31 27 112 01 6	4014586240251	HM Ultra-core drill Ø 38/35 HM QI	62,77	20	165
6 31 27 113 01 0	4014586240268	HM Ultra-core drill Ø 39/35 HM QI	62,77	20	165
6 31 27 114 01 8	4014586240275	HM Ultra-core drill Ø 40/35 HM QI	62,77	20	165
6 31 27 115 01 2	4014586240282	HM Ultra-core drill Ø 41/35 HM QI	74,18	20	165
6 31 27 116 01 5	4014586240299	HM Ultra-core drill Ø 42/35 HM QI	74,18	20	165
6 31 27 117 01 9	4014586240305	HM Ultra-core drill Ø 43/35 HM QI	74,18	20	165
6 31 27 118 01 7	4014586240312	HM Ultra-core drill Ø 44/35 HM QI	74,18	20	165
6 31 27 119 01 1	4014586240329	HM Ultra-core drill Ø 45/35 HM QI	74,18	20	165
6 31 27 120 01 3	4014586240336	HM Ultra-core drill Ø 46/35 HM QI	82,79	20	165
6 31 27 121 01 2	4014586240343	HM Ultra-core drill Ø 47/35 HM QI	82,79	20	165
6 31 27 122 01 5	4014586240350	HM Ultra-core drill Ø 48/35 HM QI	82,79	20	165
6 31 27 123 01 9	4014586240367	HM Ultra-core drill Ø 49/35 HM QI	82,79	20	165
6 31 27 124 01 7	4014586240374	HM Ultra-core drill Ø 50/35 HM QI	82,79	20	165
6 31 27 125 01 1	4014586240381	HM Ultra-core drill Ø 51/35 HM QI	91,43	20	165
6 31 27 126 01 4	4014586240398	HM Ultra-core drill Ø 52/35 HM QI	91,43	20	165
6 31 27 127 01 8	4014586240404	HM Ultra-core drill Ø 53/35 HM QI	91,43	20	165
6 31 27 128 01 6	4014586240411	HM Ultra-core drill Ø 54/35 HM QI	91,43	20	165



Part number	EAN	Description	Price in €	PC	Page
6 31 27 129 01 0	4014586240428	HM Ultra-core drill Ø 55/35 HM QI	91,43	20	165
6 31 27 130 01 2	4014586240435	HM Ultra-core drill Ø 56/35 HM QI	95,39	20	165
6 31 27 131 01 1	4014586240442	HM Ultra-core drill Ø 57/35 HM QI	95,39	20	165
6 31 27 132 01 4	4014586240459	HM Ultra-core drill Ø 58/35 HM QI	95,39	20	165
6 31 27 133 01 8	4014586240466	HM Ultra-core drill Ø 59/35 HM QI	95,39	20	165
6 31 27 134 01 6	4014586240473	HM Ultra-core drill Ø 60/35 HM QI	95,39	20	165
6 31 27 135 01 0	4014586240480	HM Ultra-core drill Ø 61/35 HM QI	107,89	20	165
6 31 27 136 01 3	4014586240497	HM Ultra-core drill Ø 62/35 HM QI	107,89	20	165
6 31 27 137 01 7	4014586240503	HM Ultra-core drill Ø 63/35 HM QI	107,89	20	165
6 31 27 138 01 5	4014586240510	HM Ultra-core drill Ø 64/35 HM QI	107,89	20	165
6 31 27 139 01 9	4014586240527	HM Ultra-core drill Ø 65/35 HM QI	107,89	20	165
6 31 27 238 01 1	4014586252469	HM Ultra-core drill Ø 15.5/35 HM QI	47,11	20	165
6 31 27 239 01 5	4014586252476	HM Ultra-core drill Ø 17.5/35 HM QI	47,11	20	165
6 31 27 240 01 7	4014586252483	HM Ultra-core drill Ø 19.5/35 HM QI	47,11	20	165
6 31 27 241 01 6	4014586252490	HM Ultra-core drill Ø 26.5/35 HM QI	47,11	20	165
6 31 27 276 01 0	4014586272122	HM Ultra50 core drill Weldon Ø 12/50	50,84	20	166
6 31 27 276 02 0	4014586375540	Best of core bits HM Ultra 50 W 12,14,16,18,20,22 mm accessory set	255,17	20	165
6 31 27 277 01 0	4014586272139	HM Ultra50 core drill Weldon Ø 13/50	50,84	20	166
6 31 27 278 01 0	4014586272146	HM Ultra50 core drill Weldon Ø 14/50	50,84	20	166
6 31 27 279 01 0	4014586272153	HM Ultra50 core drill Weldon Ø 15/50	50,84	20	166
6 31 27 280 01 0	4014586272160	HM Ultra50 core drill Weldon Ø 16/50	50,84	20	166
6 31 27 281 01 0	4014586272177	HM Ultra50 core drill Weldon Ø 17/50	50,84	20	166
6 31 27 282 01 0	4014586272184	HM Ultra50 core drill Weldon Ø 18/50	50,84	20	166
6 31 27 283 01 0	4014586272191	HM Ultra50 core drill Weldon Ø 19/50	50,84	20	166
6 31 27 284 01 0	4014586272207	HM Ultra50 core drill Weldon Ø 20/50	50,84	20	166
6 31 27 285 01 0	4014586272214	HM Ultra50 core drill Weldon Ø 21/50	50,84	20	166
6 31 27 286 01 0	4014586272221	HM Ultra50 core drill Weldon Ø 22/50	50,84	20	166
6 31 27 287 01 0	4014586272238	HM Ultra50 core drill Weldon Ø 23/50	50,84	20	166
6 31 27 288 01 0	4014586272245	HM Ultra50 core drill Weldon Ø 24/50	50,84	20	166
6 31 27 289 01 0	4014586272252	HM Ultra50 core drill Weldon Ø 25/50	50,84	20	166
6 31 27 290 01 0	4014586272269	HM Ultra50 core drill Weldon Ø 26/50	50,84	20	166
6 31 27 291 01 0	4014586272276	HM Ultra50 core drill Weldon Ø 27/50	50,84	20	166
6 31 27 292 01 0	4014586272283	HM Ultra50 core drill Weldon Ø 28/50	50,84	20	166
6 31 27 293 01 0	4014586272290	HM Ultra50 core drill Weldon Ø 29/50	50,84	20	166
6 31 27 294 01 0	4014586272306	HM Ultra50 core drill Weldon Ø 30/50	50,84	20	166
6 31 27 295 01 0	4014586272313	HM Ultra50 core drill Weldon Ø 31/50	56,83	20	166
6 31 27 296 01 0	4014586272320	HM Ultra50 core drill Weldon Ø 32/50	56,83	20	166
6 31 27 297 01 0	4014586272337	HM Ultra50 core drill Weldon Ø 33/50	56,83	20	166
6 31 27 298 01 0	4014586272344	HM Ultra50 core drill Weldon Ø 34/50	56,83	20	166
6 31 27 299 01 0	4014586272351	HM Ultra50 core drill Weldon Ø 35/50	56,83	20	166
6 31 27 300 01 0	4014586272368	HM Ultra50 core drill Weldon Ø 36/50	65,79	20	166
6 31 27 301 01 0	4014586272375	HM Ultra50 core drill Weldon Ø 37/50	65,79	20	166
6 31 27 302 01 0	4014586272382	HM Ultra50 core drill Weldon Ø 38/50	65,79	20	166
6 31 27 303 01 0	4014586272399	HM Ultra50 core drill Weldon Ø 39/50	65,79	20	166
6 31 27 304 01 0	4014586272405	HM Ultra50 core drill Weldon Ø 40/50	65,79	20	166
6 31 27 305 01 0	4014586272412	HM Ultra50 core drill Weldon Ø 41/50	77,70	20	166
6 31 27 306 01 0	4014586272429	HM Ultra50 core drill Weldon Ø 42/50	77,70	20	167
6 31 27 307 01 0	4014586272436	HM Ultra50 core drill Weldon Ø 43/50	77,70	20	167
6 31 27 308 01 0	4014586272443	HM Ultra50 core drill Weldon Ø 44/50	77,70	20	167
6 31 27 309 01 0	4014586272450	HM Ultra50 core drill Weldon Ø 45/50	77,70	20	167
6 31 27 310 01 0	4014586272467	HM Ultra50 core drill Weldon Ø 46/50	86,76	20	167
6 31 27 311 01 0	4014586272474	HM Ultra50 core drill Weldon Ø 47/50	86,76	20	167
6 31 27 312 01 0	4014586272481	HM Ultra50 core drill Weldon Ø 48/50	86,76	20	167
6 31 27 313 01 0	4014586272498	HM Ultra50 core drill Weldon Ø 49/50	86,76	20	167
6 31 27 314 01 0	4014586272504	HM Ultra50 core drill Weldon Ø 50/50	86,76	20	167
6 31 27 315 01 0	4014586272511	HM Ultra50 core drill Weldon Ø 51/50	95,87	20	167
6 31 27 316 01 0	4014586272528	HM Ultra50 core drill Weldon Ø 52/50	95,87	20	167
6 31 27 317 01 0	4014586272535	HM Ultra50 core drill Weldon Ø 53/50	95,87	20	167
6 31 27 318 01 0	4014586272542	HM Ultra50 core drill Weldon Ø 54/50	95,87	20	167
6 31 27 319 01 0	4014586272559	HM Ultra50 core drill Weldon Ø 55/50	95,87	20	167
6 31 27 320 01 0	4014586272566	HM Ultra50 core drill Weldon Ø 56/50	99,92	20	167
6 31 27 321 01 0	4014586272573	HM Ultra50 core drill Weldon Ø 57/50	99,92	20	167
6 31 27 322 01 0	4014586272580	HM Ultra50 core drill Weldon Ø 58/50	99,92	20	167
6 31 27 323 01 0	4014586272597	HM Ultra50 core drill Weldon Ø 59/50	99,92	20	167
6 31 27 324 01 0	4014586272603	HM Ultra50 core drill Weldon Ø 60/50	99,92	20	167
6 31 27 325 01 0	4014586272610	HM Ultra50 core drill Weldon Ø 61/50	113,06	20	167
6 31 27 326 01 0	4014586272627	HM Ultra50 core drill Weldon Ø 62/50	113,06	20	167
6 31 27 327 01 0	4014586272634	HM Ultra50 core drill Weldon Ø 63/50	113,06	20	167
6 31 27 328 01 0	4014586272641	HM Ultra50 core drill Weldon Ø 64/50	113,06	20	167
6 31 27 329 01 0	4014586272658	HM Ultra50 core drill Weldon Ø 65/50	113,06	20	167
6 31 27 330 01 0	4014586279732	HM Ultra50 core drill QuickIN MAX Ø 50/50	86,76	20	176
6 31 27 331 01 0	4014586279749	HM Ultra50 core drill QuickIN MAX Ø 51/50	95,87	20	176
6 31 27 332 01 0	4014586279756	HM Ultra50 core drill QuickIN MAX Ø 52/50	95,87	20	176
6 31 27 333 01 0	4014586279763	HM Ultra50 core drill QuickIN MAX Ø 53/50	95,87	20	176
6 31 27 334 01 0	4014586279770	HM Ultra50 core drill QuickIN MAX Ø 54/50	95,87	20	176
6 31 27 335 01 0	4014586279787	HM Ultra50 core drill QuickIN MAX Ø 55/50	95,87	20	176



Part number	EAN	Description	Price in €	PC	Page
6 31 27 336 01 0	4014586279794	HM Ultra50 core drill QuickIN MAX Ø 56/50	99,92	20	176
6 31 27 337 01 0	4014586279800	HM Ultra50 core drill QuickIN MAX Ø 57/50	99,92	20	176
6 31 27 338 01 0	4014586279817	HM Ultra50 core drill QuickIN MAX Ø 58/50	99,92	20	176
6 31 27 339 01 0	4014586279824	HM Ultra50 core drill QuickIN MAX Ø 59/50	99,92	20	176
6 31 27 340 01 0	4014586279831	HM Ultra50 core drill QuickIN MAX Ø 60/50	99,92	20	176
6 31 27 341 01 0	4014586279848	HM Ultra50 core drill QuickIN MAX Ø 61/50	113,06	20	176
6 31 27 342 01 0	4014586279855	HM Ultra50 core drill QuickIN MAX Ø 62/50	113,06	20	176
6 31 27 343 01 0	4014586279862	HM Ultra50 core drill QuickIN MAX Ø 63/50	113,06	20	176
6 31 27 344 01 0	4014586279879	HM Ultra50 core drill QuickIN MAX Ø 64/50	113,06	20	176
6 31 27 345 01 0	4014586279886	HM Ultra50 core drill QuickIN MAX Ø 65/50	113,06	20	176
6 31 27 346 01 0	4014586279893	HM Ultra50 core drill QuickIN MAX Ø 66/50	129,71	20	176
6 31 27 347 01 0	4014586279909	HM Ultra50 core drill QuickIN MAX Ø 67/50	129,71	20	176
6 31 27 348 01 0	4014586279916	HM Ultra50 core drill QuickIN MAX Ø 68/50	129,71	20	176
6 31 27 349 01 0	4014586279923	HM Ultra50 core drill QuickIN MAX Ø 69/50	129,71	20	176
6 31 27 350 01 0	4014586279930	HM Ultra50 core drill QuickIN MAX Ø 70/50	143,25	20	176
6 31 27 351 01 0	4014586279947	HM Ultra50 core drill QuickIN MAX Ø 71/50	144,62	20	176
6 31 27 352 01 0	4014586279954	HM Ultra50 core drill QuickIN MAX Ø 72/50	145,97	20	176
6 31 27 353 01 0	4014586279961	HM Ultra50 core drill QuickIN MAX Ø 73/50	147,32	20	176
6 31 27 354 01 0	4014586279978	HM Ultra50 core drill QuickIN MAX Ø 74/50	148,68	20	176
6 31 27 355 01 0	4014586279985	HM Ultra50 core drill QuickIN MAX Ø 75/50	150,02	20	176
6 31 27 383 01 0	4014586286686	HM-Ultra2" core drill Ø 1/2"	54,47	20	-
6 31 27 384 01 0	4014586286693	HM-Ultra2" core drill Ø 9/16"	54,47	20	-
6 31 27 386 01 0	4014586286716	HM-Ultra2" core drill Ø 11/16"	54,47	20	-
6 31 27 388 01 0	4014586286730	HM-Ultra2" core drill Ø 13/16"	54,47	20	-
6 31 27 391 01 0	4014586286761	HM-Ultra2" core drill Ø 1"	54,47	20	-
6 31 27 395 01 0	4014586286808	HM-Ultra2" core drill Ø 1-1/4"	60,88	20	-
6 31 27 396 01 0	4014586286815	HM-Ultra2" core drill Ø 1-5/16"	60,88	20	-
6 31 27 401 01 0	4014586286860	HM-Ultra2" core drill Ø 1-5/8"	83,24	20	-
6 31 27 405 01 0	4014586286907	HM-Ultra2" core drill Ø 1-7/8"	92,96	20	-
6 31 27 407 01 0	4014586286921	HM-Ultra2" core drill Ø 2"	95,87	20	-
6 31 27 408 01 0	4014586286938	HM-Ultra2" core drill Ø 2-1/16"	95,87	20	-
6 31 27 456 01 0	4014586304083	HM Ultra50 core drill QuickIN MAX Ø 76/50	156,79	20	176
6 31 27 457 01 0	4014586304090	HM Ultra50 core drill QuickIN MAX Ø 77/50	158,15	20	176
6 31 27 458 01 0	4014586304106	HM Ultra50 core drill QuickIN MAX Ø 78/50	160,16	20	176
6 31 27 459 01 0	4014586304113	HM Ultra50 core drill QuickIN MAX Ø 79/50	162,21	20	176
6 31 27 460 01 0	4014586304120	HM Ultra50 core drill QuickIN MAX Ø 80/50	162,21	20	176
6 31 27 714 01 0	4014586346632	TCT Ultra 35 core bit with 3/4" Weldon holder	45,75	20	156
6 31 27 714 02 0	4014586375557	Best of core bits HM Ultra 35 W 12,14,16,18,20,22 mm accessory set	221,74	20	154
6 31 27 715 01 0	4014586346649	TCT Ultra 35 core bit with 3/4" Weldon holder	45,75	20	156
6 31 27 716 01 0	4014586346656	TCT Ultra 35 core bit with 3/4" Weldon holder	45,75	20	156
6 31 27 717 01 0	4014586346663	TCT Ultra 35 core bit with 3/4" Weldon holder	45,75	20	156
6 31 27 718 01 0	4014586346670	TCT Ultra 35 core bit with 3/4" Weldon holder	45,75	20	156
6 31 27 719 01 0	4014586346687	TCT Ultra 35 core bit with 3/4" Weldon holder	45,75	20	156
6 31 27 720 01 0	4014586346694	TCT Ultra 35 core bit with 3/4" Weldon holder	45,75	20	156
6 31 27 721 01 0	4014586346700	TCT Ultra 35 core bit with 3/4" Weldon holder	45,75	20	156
6 31 27 722 01 0	4014586346717	TCT Ultra 35 core bit with 3/4" Weldon holder	45,75	20	156
6 31 27 723 01 0	4014586346724	TCT Ultra 35 core bit with 3/4" Weldon holder	45,75	20	156
6 31 27 724 01 0	4014586346731	TCT Ultra 35 core bit with 3/4" Weldon holder	45,75	20	156
6 31 27 725 01 0	4014586346748	TCT Ultra 35 core bit with 3/4" Weldon holder	45,75	20	156
6 31 27 726 01 0	4014586346755	TCT Ultra 35 core bit with 3/4" Weldon holder	45,75	20	156
6 31 27 727 01 0	4014586346762	TCT Ultra 35 core bit with 3/4" Weldon holder	45,75	20	156
6 31 27 728 01 0	4014586346779	TCT Ultra 35 core bit with 3/4" Weldon holder	45,75	20	156
6 31 27 729 01 0	4014586346786	TCT Ultra 35 core bit with 3/4" Weldon holder	45,75	20	156
6 31 27 730 01 0	4014586346793	TCT Ultra 35 core bit with 3/4" Weldon holder	45,75	20	156
6 31 27 731 01 0	4014586346809	TCT Ultra 35 core bit with 3/4" Weldon holder	52,65	20	156
6 31 27 732 01 0	4014586346816	TCT Ultra 35 core bit with 3/4" Weldon holder	52,65	20	156
6 31 27 733 01 0	4014586346823	TCT Ultra 35 core bit with 3/4" Weldon holder	52,65	20	156
6 31 27 734 01 0	4014586346830	TCT Ultra 35 core bit with 3/4" Weldon holder	52,65	20	156
6 31 27 735 01 0	4014586346847	TCT Ultra 35 core bit with 3/4" Weldon holder	52,65	20	156
6 31 27 736 01 0	4014586346854	TCT Ultra 35 core bit with 3/4" Weldon holder	52,65	20	156
6 31 27 737 01 0	4014586346861	TCT Ultra 35 core bit with 3/4" Weldon holder	52,65	20	156
6 31 27 738 01 0	4014586346878	TCT Ultra 35 core bit with 3/4" Weldon holder	60,94	20	156
6 31 27 739 01 0	4014586346885	TCT Ultra 35 core bit with 3/4" Weldon holder	60,94	20	156
6 31 27 740 01 0	4014586346892	TCT Ultra 35 core bit with 3/4" Weldon holder	60,94	20	156
6 31 27 741 01 0	4014586346908	TCT Ultra 35 core bit with 3/4" Weldon holder	60,94	20	156
6 31 27 742 01 0	4014586346915	TCT Ultra 35 core bit with 3/4" Weldon holder	60,94	20	156
6 31 27 743 01 0	4014586346922	TCT Ultra 35 core bit with 3/4" Weldon holder	72,03	20	156
6 31 27 744 01 0	4014586346939	TCT Ultra 35 core bit with 3/4" Weldon holder	72,03	20	156
6 31 27 745 01 0	4014586346946	TCT Ultra 35 core bit with 3/4" Weldon holder	72,03	20	156
6 31 27 746 01 0	4014586346953	TCT Ultra 35 core bit with 3/4" Weldon holder	72,03	20	156
6 31 27 747 01 0	4014586346960	TCT Ultra 35 core bit with 3/4" Weldon holder	72,03	20	156
6 31 27 748 01 0	4014586346977	TCT Ultra 35 core bit with 3/4" Weldon holder	80,36	20	156
6 31 27 749 01 0	4014586346984	TCT Ultra 35 core bit with 3/4" Weldon holder	80,36	20	156
6 31 27 750 01 0	4014586346991	TCT Ultra 35 core bit with 3/4" Weldon holder	80,36	20	156
6 31 27 751 01 0	4014586347004	TCT Ultra 35 core bit with 3/4" Weldon holder	80,36	20	156
6 31 27 752 01 0	4014586347011	TCT Ultra 35 core bit with 3/4" Weldon holder	80,36	20	156

Part number	EAN	Description	Price in €	PC	Page
6 31 27 753 01 0	4014586347028	TCT Ultra 35 core bit with 3/4" Weldon holder	88,78	20	156
6 31 27 754 01 0	4014586347035	TCT Ultra 35 core bit with 3/4" Weldon holder	88,78	20	156
6 31 27 755 01 0	4014586347042	TCT Ultra 35 core bit with 3/4" Weldon holder	88,78	20	156
6 31 27 756 01 0	4014586347059	TCT Ultra 35 core bit with 3/4" Weldon holder	88,78	20	156
6 31 27 757 01 0	4014586347066	TCT Ultra 35 core bit with 3/4" Weldon holder	88,78	20	156
6 31 27 758 01 0	4014586347073	TCT Ultra 35 core bit with 3/4" Weldon holder	92,61	20	156
6 31 27 759 01 0	4014586347080	TCT Ultra 35 core bit with 3/4" Weldon holder	92,61	20	156
6 31 27 760 01 0	4014586347097	TCT Ultra 35 core bit with 3/4" Weldon holder	92,61	20	156
6 31 27 761 01 0	4014586347103	TCT Ultra 35 core bit with 3/4" Weldon holder	92,61	20	156
6 31 27 762 01 0	4014586347110	TCT Ultra 35 core bit with 3/4" Weldon holder	92,61	20	156
6 31 27 763 01 0	4014586353265	TCT Ultra core bit with QuickIN holder	68,59	20	165
6 31 27 764 01 0	4014586353272	TCT Ultra core bit with QuickIN holder	68,59	20	165
6 31 27 765 01 0	4014586353289	TCT Ultra core bit with QuickIN holder	68,59	20	165
6 31 27 766 01 0	4014586353296	TCT Ultra core bit with QuickIN holder	68,59	20	165
6 31 27 767 01 0	4014586353302	TCT Ultra core bit with QuickIN holder	68,59	20	165
6 31 27 768 01 0	4014586353319	TCT Ultra core bit with QuickIN holder	68,59	20	165
6 31 27 769 01 0	4014586353326	TCT Ultra core bit with QuickIN holder	68,59	20	165
6 31 27 770 01 0	4014586353333	TCT Ultra core bit with QuickIN holder	68,59	20	165
6 31 27 771 01 0	4014586353340	TCT Ultra core bit with QuickIN holder	68,59	20	165
6 31 27 772 01 0	4014586353357	TCT Ultra core bit with QuickIN holder	68,59	20	165
6 31 27 773 01 0	4014586353364	TCT Ultra core bit with QuickIN holder	68,59	20	165
6 31 27 774 01 0	4014586353371	TCT Ultra core bit with QuickIN holder	75,52	20	165
6 31 27 775 01 0	4014586353388	TCT Ultra core bit with QuickIN holder	75,52	20	165
6 31 27 776 01 0	4014586353395	TCT Ultra core bit with QuickIN holder	75,52	20	165
6 31 27 777 01 0	4014586353401	TCT Ultra core bit with QuickIN holder	75,52	20	165
6 31 27 778 01 0	4014586353418	TCT Ultra core bit with QuickIN holder	83,87	20	165
6 31 27 779 01 0	4014586353425	TCT Ultra core bit with QuickIN holder	83,87	20	165
6 31 27 780 01 0	4014586353432	TCT Ultra core bit with QuickIN holder	94,99	20	165
6 31 27 781 01 0	4014586353449	TCT Ultra core bit with QuickIN holder	103,37	20	165
6 31 27 782 01 0	4014586353456	TCT Ultra core bit with QuickIN holder	111,84	20	165
6 31 27 783 01 0	4014586353463	TCT Ultra core bit with QuickIN holder	115,68	20	165
6 31 27 784 01 0	4014586353470	TCT Ultra core bit with QuickIN holder	127,88	20	165
6 31 27 785 01 0	4014586353487	TCT Ultra 75 core bit with 3/4" Weldon holder	68,59	20	167
6 31 27 786 01 0	4014586353494	TCT Ultra 75 core bit with 3/4" Weldon holder	68,59	20	167
6 31 27 787 01 0	4014586353500	TCT Ultra 75 core bit with 3/4" Weldon holder	68,59	20	167
6 31 27 788 01 0	4014586353517	TCT Ultra 75 core bit with 3/4" Weldon holder	68,59	20	167
6 31 27 789 01 0	4014586353524	TCT Ultra 75 core bit with 3/4" Weldon holder	68,59	20	167
6 31 27 790 01 0	4014586353531	TCT Ultra 75 core bit with 3/4" Weldon holder	68,59	20	167
6 31 27 791 01 0	4014586353548	TCT Ultra 75 core bit with 3/4" Weldon holder	68,59	20	167
6 31 27 792 01 0	4014586353555	TCT Ultra 75 core bit with 3/4" Weldon holder	68,59	20	167
6 31 27 793 01 0	4014586353562	TCT Ultra 75 core bit with 3/4" Weldon holder	68,59	20	167
6 31 27 794 01 0	4014586353579	TCT Ultra 75 core bit with 3/4" Weldon holder	68,59	20	167
6 31 27 795 01 0	4014586353586	TCT Ultra 75 core bit with 3/4" Weldon holder	68,59	20	167
6 31 27 796 01 0	4014586353593	TCT Ultra 75 core bit with 3/4" Weldon holder	75,52	20	167
6 31 27 797 01 0	4014586353609	TCT Ultra 75 core bit with 3/4" Weldon holder	75,52	20	167
6 31 27 798 01 0	4014586353616	TCT Ultra 75 core bit with 3/4" Weldon holder	75,52	20	167
6 31 27 799 01 0	4014586353623	TCT Ultra 75 core bit with 3/4" Weldon holder	75,52	20	167
6 31 27 800 01 0	4014586353630	TCT Ultra 75 core bit with 3/4" Weldon holder	83,87	20	167
6 31 27 801 01 0	4014586353647	TCT Ultra 75 core bit with 3/4" Weldon holder	83,87	20	167
6 31 27 802 01 0	4014586353654	TCT Ultra 75 core bit with 3/4" Weldon holder	94,99	20	167
6 31 27 803 01 0	4014586353661	TCT Ultra 75 core bit with 3/4" Weldon holder	103,37	20	167
6 31 27 804 01 0	4014586353678	TCT Ultra 75 core bit with 3/4" Weldon holder	111,84	20	167
6 31 27 805 01 0	4014586353685	TCT Ultra 75 core bit with 3/4" Weldon holder	115,68	20	167
6 31 27 806 01 0	4014586353692	TCT Ultra 75 core bit with 3/4" Weldon holder	127,88	20	167
6 31 30 014 01 0	4014586331034	Core bit D14/20 HM QIP	42,36	20	148
6 31 30 015 01 0	4014586331041	Core bit D15/20 HM QIP	42,36	20	148
6 31 30 016 01 0	4014586331058	Core bit D16/20 HM QIP	42,36	20	148
6 31 30 017 01 0	4014586331065	Core bit D17/20 HM QIP	42,36	20	148
6 31 30 018 01 0	4014586331072	Core bit D18/20 HM QIP	42,36	20	148
6 31 30 019 01 0	4014586331089	Core bit D19/20 HM QIP	42,36	20	148
6 31 30 020 01 0	4014586331096	Core bit D20/20 HM QIP	42,36	20	148
6 31 30 021 01 0	4014586331102	Core bit D21/20 HM QIP	42,36	20	148
6 31 30 022 01 0	4014586331119	Core bit D22/20 HM QIP	42,36	20	148
6 31 30 023 01 0	4014586331126	Core bit D23/20 HM QIP	42,36	20	148
6 31 30 024 01 0	4014586331133	Core bit D24/20 HM QIP	44,11	20	148
6 31 30 025 01 0	4014586331140	Core bit D25/20 HM QIP	44,11	20	148
6 31 30 026 01 0	4014586331157	Core bit D26/20 HM QIP	44,11	20	148
6 31 30 027 01 0	4014586331164	Core bit D27/20 HM QIP	44,11	20	148
6 31 30 028 01 0	4014586331171	Core bit D28/20 HM QIP	44,11	20	148
6 31 30 029 01 0	4014586331188	Core bit D29/20 HM QIP	47,05	20	148
6 31 30 030 01 0	4014586331195	Core bit D30/20 HM QIP	47,05	20	148
6 31 30 114 01 0	4014586331409	Core bit D14/20 HM QIP	54,00	20	148
6 31 30 115 01 0	4014586331416	Core bit D15/20 HM QIP	54,00	20	148
6 31 30 115 51 0	4014586368986	Carbide core drill bit with QuickIN PLUS holder	52,43	20	-
6 31 30 116 01 0	4014586331423	Core bit D16/20 HM QIP	54,00	20	148
6 31 30 117 01 0	4014586331430	Core bit D17/20 HM QIP	54,00	20	148

Part number	EAN	Description	Price in €	PC	Page
6 31 30 117 51 0	4014586368993	Carbide core drill bit with QuickIN PLUS holder	52,43	20	-
6 31 30 118 01 0	4014586331447	Core bit D18/20 HM QIP	56,93	20	148
6 31 30 119 01 0	4014586331454	Core bit D19/20 HM QIP	56,93	20	148
6 31 30 119 51 0	4014586369006	Carbide core drill bit with QuickIN PLUS holder	55,27	20	-
6 31 30 120 01 0	4014586331461	Core bit D20/20 HM QIP	56,93	20	148
6 31 30 121 01 0	4014586331478	Core bit D21/20 HM QIP	56,93	20	148
6 31 30 122 01 0	4014586331485	Core bit D22/20 HM QIP	56,93	20	148
6 31 30 123 01 0	4014586331492	Core bit D23/20 HM QIP	56,93	20	148
6 31 30 124 01 0	4014586331508	Core bit D24/20 HM QIP	60,48	20	148
6 31 30 125 01 0	4014586331515	Core bit D25/20 HM QIP	60,48	20	148
6 31 30 126 01 0	4014586331522	Core bit D26/20 HM QIP	60,48	20	148
6 31 30 127 01 0	4014586331539	Core bit D27/20 HM QIP	60,48	20	148
6 31 30 128 01 0	4014586331546	Core bit D28/20 HM QIP	60,48	20	148
6 31 30 129 01 0	4014586331553	Core bit D29/20 HM QIP	60,48	20	148
6 31 30 130 01 0	4014586331560	Core bit D30/20 HM QIP	60,48	20	148
6 31 30 200 01 0	4014586331201	Core bit D9/16" x 3/4" HM QIP	48,83	20	-
6 31 30 201 01 0	4014586331218	Core bit D5/8" x 3/4" HM QIP	48,83	20	-
6 31 30 202 01 0	4014586331225	Core bit D11/16" x 3/4" HM QIP	48,83	20	-
6 31 30 203 01 0	4014586331232	Core bit D3/4" x 3/4" HM QIP	48,83	20	-
6 31 30 204 01 0	4014586331249	Core bit D13/16" x 3/4" HM QIP	48,83	20	-
6 31 30 205 01 0	4014586331256	Core bit D7/8" x 3/4" HM QIP	48,83	20	-
6 31 30 206 01 0	4014586331263	Core bit D15/16" x 3/4" HM QIP	51,19	20	-
6 31 30 207 01 0	4014586331270	Core bit D1" x 3/4" HM QIP	51,19	20	-
6 31 30 208 01 0	4014586331287	Core bit D1 1/16" x 3/4" HM QIP	51,19	20	-
6 31 30 209 01 0	4014586331294	Core bit D1 1/8" x 3/4" HM QIP	54,11	20	-
6 31 30 210 01 0	4014586331300	Core bit D1 3/16" x 3/4" HM QIP	54,11	20	-
6 31 30 300 01 0	4014586331577	Core bit D9/16" x 3/4" HM QIP	57,77	20	-
6 31 30 301 01 0	4014586331584	Core bit D5/8" x 3/4" HM QIP	57,77	20	-
6 31 30 302 01 0	4014586331591	Core bit D11/16" x 3/4" HM QIP	57,77	20	-
6 31 30 303 01 0	4014586331607	Core bit D3/4" x 3/4" HM QIP	60,94	20	-
6 31 30 304 01 0	4014586331614	Core bit D13/16" x 3/4" HM QIP	60,94	20	-
6 31 30 305 01 0	4014586331621	Core bit D7/8" x 3/4" HM QIP	60,94	20	-
6 31 30 306 01 0	4014586331638	Core bit D15/16" x 3/4" HM QIP	64,70	20	-
6 31 30 307 01 0	4014586331645	Core bit D1" x 3/4" HM QIP	64,70	20	-
6 31 30 308 01 0	4014586331652	Core bit D1-1/16" x 3/4" HM QIP	64,70	20	-
6 31 30 309 01 0	4014586331669	Core bit D1-1/8" x 3/4" HM QIP	64,70	20	-
6 31 30 310 01 0	4014586331676	Core bit D1-3/16" x 3/4" HM QIP	64,70	20	-
6 31 31 014 01 0	4014586333274	Carbide hole saw with QuickIN PLUS holder Ø 14	32,94	20	148
6 31 31 015 01 0	4014586333281	Carbide hole saw with QuickIN PLUS holder Ø 15	32,94	20	148
6 31 31 016 01 0	4014586333298	Carbide hole saw with QuickIN PLUS holder Ø 16	32,94	20	148
6 31 31 017 01 0	4014586333304	Carbide hole saw with QuickIN PLUS holder Ø 17	32,94	20	148
6 31 31 018 01 0	4014586333311	Carbide hole saw with QuickIN PLUS holder Ø 18	32,94	20	148
6 31 31 019 01 0	4014586333328	Carbide hole saw with QuickIN PLUS holder Ø 19	32,94	20	148
6 31 31 020 01 0	4014586333335	Carbide hole saw with QuickIN PLUS holder Ø 20	37,07	20	148
6 31 31 021 01 0	4014586333922	Carbide hole saw with QuickIN PLUS holder Ø 21	37,07	20	148
6 31 31 022 01 0	4014586333342	Carbide hole saw with QuickIN PLUS holder Ø 22	37,07	20	148
6 31 31 023 01 0	4014586333939	Carbide hole saw with QuickIN PLUS holder Ø 23	37,07	20	148
6 31 31 024 01 0	4014586333359	Carbide hole saw with QuickIN PLUS holder Ø 24	37,07	20	148
6 31 31 025 01 0	4014586333366	Carbide hole saw with QuickIN PLUS holder Ø 25	37,07	20	148
6 31 31 026 01 0	4014586333373	Carbide hole saw with QuickIN PLUS holder Ø 26	37,07	20	148
6 31 31 027 01 0	4014586333380	Carbide hole saw with QuickIN PLUS holder Ø 27	37,07	20	148
6 31 31 028 01 0	4014586333946	Carbide hole saw with QuickIN PLUS holder Ø 28	37,07	20	148
6 31 31 029 01 0	4014586333397	Carbide hole saw with QuickIN PLUS holder Ø 29	39,88	20	148
6 31 31 030 01 0	4014586333403	Carbide hole saw with QuickIN PLUS holder Ø 30	39,88	20	148
6 31 31 031 01 0	4014586333953	Carbide hole saw with QuickIN PLUS holder Ø 31	42,93	20	148
6 31 31 032 01 0	4014586333410	Carbide hole saw with QuickIN PLUS holder Ø 32	42,93	20	148
6 31 31 033 01 0	4014586333427	Carbide hole saw with QuickIN PLUS holder Ø 33	42,93	20	148
6 31 31 034 01 0	4014586333960	Carbide hole saw with QuickIN PLUS holder Ø 34	46,23	20	148
6 31 31 035 01 0	4014586333434	Carbide hole saw with QuickIN PLUS holder Ø 35	46,23	20	148
6 31 31 036 01 0	4014586333977	Carbide hole saw with QuickIN PLUS holder Ø 36	50,72	20	148
6 31 31 037 01 0	4014586333441	Carbide hole saw with QuickIN PLUS holder Ø 37	50,72	20	148
6 31 31 038 01 0	4014586333458	Carbide hole saw with QuickIN PLUS holder Ø 38	50,72	20	148
6 31 31 039 01 0	4014586333984	Carbide hole saw with QuickIN PLUS holder Ø 39	50,72	20	148
6 31 31 040 01 0	4014586333465	Carbide hole saw with QuickIN PLUS holder Ø 40	50,72	20	148
6 31 31 041 01 0	4014586333991	Carbide hole saw with QuickIN PLUS holder Ø 41	50,72	20	148
6 31 31 042 01 0	4014586333472	Carbide hole saw with QuickIN PLUS holder Ø 42	50,72	20	148
6 31 31 043 01 0	4014586334004	Carbide hole saw with QuickIN PLUS holder Ø 43	55,64	20	148
6 31 31 044 01 0	4014586333489	Carbide hole saw with QuickIN PLUS holder Ø 44	55,64	20	148
6 31 31 045 01 0	4014586334011	Carbide hole saw with QuickIN PLUS holder Ø 45	55,64	20	148
6 31 31 046 01 0	4014586334028	Carbide hole saw with QuickIN PLUS holder Ø 46	55,64	20	148
6 31 31 047 01 0	4014586334035	Carbide hole saw with QuickIN PLUS holder Ø 47	55,64	20	148
6 31 31 048 01 0	4014586334042	Carbide hole saw with QuickIN PLUS holder Ø 48	59,41	20	148
6 31 31 049 01 0	4014586334059	Carbide hole saw with QuickIN PLUS holder Ø 49	59,41	20	148
6 31 31 050 01 0	4014586334096	Carbide hole saw with QuickIN PLUS holder Ø 50	59,41	20	148
6 31 31 051 01 0	4014586333502	Carbide hole saw with QuickIN PLUS holder Ø 51	59,41	20	148
6 31 31 052 01 0	4014586334066	Carbide hole saw with QuickIN PLUS holder Ø 52	59,41	20	148



Part number	EAN	Description	Price in €	PC	Page
6 31 31 053 01 0	4014586334073	Carbide hole saw with QuickIN PLUS holder Ø 53	61,17	20	148
6 31 31 054 01 0	4014586333519	Carbide hole saw with QuickIN PLUS holder Ø 54	61,17	20	148
6 31 31 055 01 0	4014586366470	Carbide hole saw with QuickIN PLUS holder	63,51	20	148
6 31 31 056 01 0	4014586366487	Carbide hole saw with QuickIN PLUS holder	69,08	20	148
6 31 31 057 01 0	4014586366494	Carbide hole saw with QuickIN PLUS holder	74,66	20	148
6 31 31 058 01 0	4014586366500	Carbide hole saw with QuickIN PLUS holder	80,23	20	148
6 31 31 059 01 0	4014586366517	Carbide hole saw with QuickIN PLUS holder	86,91	20	148
6 31 31 060 01 0	4014586366524	Carbide hole saw with QuickIN PLUS holder	93,60	20	148
6 31 31 065 01 0	4014586366531	Carbide hole saw with QuickIN PLUS holder	95,82	20	148
6 31 31 068 01 0	4014586366548	Carbide hole saw with QuickIN PLUS holder	99,17	20	148
6 31 31 070 01 0	4014586366555	Carbide hole saw with QuickIN PLUS holder	103,64	20	148
6 31 31 075 01 0	4014586366562	Carbide hole saw with QuickIN PLUS holder	105,86	20	148
6 31 31 080 01 0	4014586366579	Carbide hole saw with QuickIN PLUS holder	110,31	20	148
6 31 31 200 01 0	4014586334080	Carbide hole saw with QuickIN PLUS holder Ø 9/16"	37,64	20	-
6 31 31 201 01 0	4014586334097	Carbide hole saw with QuickIN PLUS holder Ø 5/8"	37,64	20	-
6 31 31 202 01 0	4014586334103	Carbide hole saw with QuickIN PLUS holder Ø 11/16"	37,64	20	-
6 31 31 203 01 0	4014586334110	Carbide hole saw with QuickIN PLUS holder Ø 3/4"	37,64	20	-
6 31 31 204 01 0	4014586334127	Carbide hole saw with QuickIN PLUS holder Ø 13/16"	42,36	20	-
6 31 31 205 01 0	4014586334134	Carbide hole saw with QuickIN PLUS holder Ø 7/8"	42,36	20	-
6 31 31 206 01 0	4014586334141	Carbide hole saw with QuickIN PLUS holder Ø 15/16"	44,70	20	-
6 31 31 207 01 0	4014586334158	Carbide hole saw with QuickIN PLUS holder Ø 1"	44,70	20	-
6 31 31 208 01 0	4014586334165	Carbide hole saw with QuickIN PLUS holder Ø 1-1/16"	44,70	20	-
6 31 31 209 01 0	4014586334172	Carbide hole saw with QuickIN PLUS holder Ø 1-1/8"	47,05	20	-
6 31 31 210 01 0	4014586334189	Carbide hole saw with QuickIN PLUS holder Ø 1-3/16"	47,05	20	-
6 31 31 211 01 0	4014586334196	Carbide hole saw with QuickIN PLUS holder Ø 1-1/4"	49,40	20	-
6 31 31 212 01 0	4014586334202	Carbide hole saw with QuickIN PLUS holder Ø 1-5/16"	49,40	20	-
6 31 31 213 01 0	4014586334219	Carbide hole saw with QuickIN PLUS holder Ø 1-3/8"	55,29	20	-
6 31 31 214 01 0	4014586334226	Carbide hole saw with QuickIN PLUS holder Ø 1-7/16"	55,29	20	-
6 31 31 215 01 0	4014586334233	Carbide hole saw with QuickIN PLUS holder Ø 1-1/2"	55,29	20	-
6 31 31 216 01 0	4014586334240	Carbide hole saw with QuickIN PLUS holder Ø 1-9/16"	58,83	20	-
6 31 31 217 01 0	4014586334257	Carbide hole saw with QuickIN PLUS holder Ø 1-5/8"	58,83	20	-
6 31 31 218 01 0	4014586334264	Carbide hole saw with QuickIN PLUS holder Ø 1-11/16"	64,70	20	-
6 31 31 219 01 0	4014586334271	Carbide hole saw with QuickIN PLUS holder Ø 1-3/4"	64,70	20	-
6 31 31 220 01 0	4014586334288	Carbide hole saw with QuickIN PLUS holder Ø 1-13/16"	64,70	20	-
6 31 31 221 01 0	4014586334295	Carbide hole saw with QuickIN PLUS holder Ø 1-7/8"	68,22	20	-
6 31 31 222 01 0	4014586334301	Carbide hole saw with QuickIN PLUS holder Ø 1-15/16"	68,22	20	-
6 31 31 223 01 0	4014586334318	Carbide hole saw with QuickIN PLUS holder Ø 2"	68,22	20	-
6 31 31 224 01 0	4014586334325	Carbide hole saw with QuickIN PLUS holder Ø 2-1/16"	68,22	20	-
6 31 31 225 01 0	4014586334332	Carbide hole saw with QuickIN PLUS holder Ø 2-1/8"	70,59	20	-
6 31 31 226 01 0	4014586366586	Carbide hole saw with QuickIN PLUS holder	82,46	20	-
6 31 31 227 01 0	4014586366593	Carbide hole saw with QuickIN PLUS holder	105,86	20	-
6 31 31 228 01 0	4014586366609	Carbide hole saw with QuickIN PLUS holder	122,57	20	-
6 31 31 229 01 0	4014586366616	Carbide hole saw with QuickIN PLUS holder	133,72	20	-
6 31 31 230 01 0	4014586366623	Carbide hole saw with QuickIN PLUS holder	133,72	20	-
6 31 31 231 01 0	4014586366630	Carbide hole saw with QuickIN PLUS holder	133,72	20	-
6 31 31 232 01 0	4014586366647	Carbide hole saw with QuickIN PLUS holder	144,86	20	-
6 31 31 233 01 0	4014586366654	Carbide hole saw with QuickIN PLUS holder	144,86	20	-
6 31 31 234 01 0	4014586366661	Carbide hole saw with QuickIN PLUS holder	144,86	20	-
6 31 31 421 01 0	4014586333526	Carbide hole saw for pipes with QuickIN PLUS holder Ø 21	41,76	20	149
6 31 31 422 01 0	4014586334349	Carbide hole saw for pipes with QuickIN PLUS holder Ø 22	41,76	20	149
6 31 31 423 01 0	4014586334356	Carbide hole saw for pipes with QuickIN PLUS holder Ø 23	41,76	20	149
6 31 31 424 01 0	4014586334363	Carbide hole saw for pipes with QuickIN PLUS holder Ø 24	41,76	20	149
6 31 31 425 01 0	4014586333533	Carbide hole saw for pipes with QuickIN PLUS holder Ø 25	41,76	20	149
6 31 31 426 01 0	4014586334370	Carbide hole saw for pipes with QuickIN PLUS holder Ø 26	41,76	20	149
6 31 31 427 01 0	4014586333540	Carbide hole saw for pipes with QuickIN PLUS holder Ø 27	41,76	20	149
6 31 31 428 01 0	4014586333557	Carbide hole saw for pipes with QuickIN PLUS holder Ø 28	41,76	20	149
6 31 31 429 01 0	4014586334387	Carbide hole saw for pipes with QuickIN PLUS holder Ø 29	44,70	20	149
6 31 31 430 01 0	4014586333564	Carbide hole saw for pipes with QuickIN PLUS holder Ø 30	44,70	20	149
6 31 31 431 01 0	4014586334394	Carbide hole saw for pipes with QuickIN PLUS holder Ø 31	50,46	20	149
6 31 31 432 01 0	4014586334400	Carbide hole saw for pipes with QuickIN PLUS holder Ø 32	50,46	20	149
6 31 31 433 01 0	4014586333571	Carbide hole saw for pipes with QuickIN PLUS holder Ø 33	50,46	20	149
6 31 31 434 01 0	4014586334417	Carbide hole saw for pipes with QuickIN PLUS holder Ø 34	53,42	20	149
6 31 31 435 01 0	4014586333588	Carbide hole saw for pipes with QuickIN PLUS holder Ø 35	53,42	20	149
6 31 31 436 01 0	4014586334424	Carbide hole saw for pipes with QuickIN PLUS holder Ø 36	59,88	20	149
6 31 31 437 01 0	4014586334431	Carbide hole saw for pipes with QuickIN PLUS holder Ø 37	59,88	20	149
6 31 31 438 01 0	4014586334448	Carbide hole saw for pipes with QuickIN PLUS holder Ø 38	59,88	20	149
6 31 31 439 01 0	4014586334455	Carbide hole saw for pipes with QuickIN PLUS holder Ø 39	59,88	20	149
6 31 31 440 01 0	4014586333595	Carbide hole saw for pipes with QuickIN PLUS holder Ø 40	59,88	20	149
6 31 31 441 01 0	4014586334462	Carbide hole saw for pipes with QuickIN PLUS holder Ø 41	68,11	20	149
6 31 31 442 01 0	4014586333601	Carbide hole saw for pipes with QuickIN PLUS holder Ø 42	68,11	20	149
6 31 31 443 01 0	4014586334479	Carbide hole saw for pipes with QuickIN PLUS holder Ø 43	68,11	20	149
6 31 31 444 01 0	4014586334486	Carbide hole saw for pipes with QuickIN PLUS holder Ø 44	68,11	20	149
6 31 31 445 01 0	4014586334493	Carbide hole saw for pipes with QuickIN PLUS holder Ø 45	68,11	20	149
6 31 31 446 01 0	4014586334509	Carbide hole saw for pipes with QuickIN PLUS holder Ø 46	73,98	20	149
6 31 31 447 01 0	4014586334516	Carbide hole saw for pipes with QuickIN PLUS holder Ø 47	73,98	20	149
6 31 31 448 01 0	4014586333618	Carbide hole saw for pipes with QuickIN PLUS holder Ø 48	73,98	20	149



Accessories in numerical order

Part number	EAN	Description	Price in €	PC	Page
6 31 31 449 01 0	4014586334523	Carbide hole saw for pipes with QuickIN PLUS holder Ø 49	73,98	20	149
6 31 31 450 01 0	4014586333625	Carbide hole saw for pipes with QuickIN PLUS holder Ø 50	73,98	20	149
6 31 31 451 01 0	4014586333632	Carbide hole saw for pipes with QuickIN PLUS holder Ø 51	76,36	20	149
6 31 31 452 01 0	4014586334530	Carbide hole saw for pipes with QuickIN PLUS holder Ø 52	76,36	20	149
6 31 31 453 01 0	4014586334547	Carbide hole saw for pipes with QuickIN PLUS holder Ø 53	76,36	20	149
6 31 31 454 01 0	4014586333649	Carbide hole saw for pipes with QuickIN PLUS holder Ø 54	76,36	20	149
6 31 31 455 01 0	4014586366678	Carbide hole saw for pipes with QuickIN PLUS holder	78,00	20	149
6 31 31 456 01 0	4014586366685	Carbide hole saw for pipes with QuickIN PLUS holder	80,23	20	149
6 31 31 457 01 0	4014586366692	Carbide hole saw for pipes with QuickIN PLUS holder	83,57	20	149
6 31 31 458 01 0	4014586366708	Carbide hole saw for pipes with QuickIN PLUS holder	91,37	20	149
6 31 31 459 01 0	4014586366715	Carbide hole saw for pipes with QuickIN PLUS holder	95,82	20	149
6 31 31 460 01 0	4014586366722	Carbide hole saw for pipes with QuickIN PLUS holder	100,29	20	149
6 31 31 465 01 0	4014586366739	Carbide hole saw for pipes with QuickIN PLUS holder	109,20	20	149
6 31 31 468 01 0	4014586366746	Carbide hole saw for pipes with QuickIN PLUS holder	115,88	20	149
6 31 31 605 01 0	4014586334554	Carbide hole saw for pipes with QuickIN PLUS holder Ø 7/8"	47,65	20	-
6 31 31 606 01 0	4014586334561	Carbide hole saw for pipes with QuickIN PLUS holder Ø 15/16"	47,65	20	-
6 31 31 607 01 0	4014586334578	Carbide hole saw for pipes with QuickIN PLUS holder Ø 1"	49,40	20	-
6 31 31 608 01 0	4014586334585	Carbide hole saw for pipes with QuickIN PLUS holder Ø 1-1/16"	49,40	20	-
6 31 31 609 01 0	4014586334592	Carbide hole saw for pipes with QuickIN PLUS holder Ø 1-1/8"	51,77	20	-
6 31 31 610 01 0	4014586334608	Carbide hole saw for pipes with QuickIN PLUS holder Ø 1-3/16"	51,77	20	-
6 31 31 611 01 0	4014586334615	Carbide hole saw for pipes with QuickIN PLUS holder Ø 1-1/4"	58,83	20	-
6 31 31 612 01 0	4014586334622	Carbide hole saw for pipes with QuickIN PLUS holder Ø 1-5/16"	58,83	20	-
6 31 31 613 01 0	4014586334639	Carbide hole saw for pipes with QuickIN PLUS holder Ø 1-3/8"	64,70	20	-
6 31 31 614 01 0	4014586334646	Carbide hole saw for pipes with QuickIN PLUS holder Ø 1-7/16"	69,42	20	-
6 31 31 615 01 0	4014586334653	Carbide hole saw for pipes with QuickIN PLUS holder Ø 1-1/2"	69,42	20	-
6 31 31 616 01 0	4014586334660	Carbide hole saw for pipes with QuickIN PLUS holder Ø 1-9/16"	69,42	20	-
6 31 31 617 01 0	4014586334677	Carbide hole saw for pipes with QuickIN PLUS holder Ø 1-5/8"	78,81	20	-
6 31 31 618 01 0	4014586334684	Carbide hole saw for pipes with QuickIN PLUS holder Ø 1-11/16"	78,81	20	-
6 31 31 619 01 0	4014586334691	Carbide hole saw for pipes with QuickIN PLUS holder Ø 1-3/4"	78,81	20	-
6 31 31 620 01 0	4014586334707	Carbide hole saw for pipes with QuickIN PLUS holder Ø 1-13/16"	85,87	20	-
6 31 31 621 01 0	4014586334714	Carbide hole saw for pipes with QuickIN PLUS holder Ø 1-7/8"	85,87	20	-
6 31 31 622 01 0	4014586334721	Carbide hole saw for pipes with QuickIN PLUS holder Ø 1-15/16"	85,87	20	-
6 31 31 623 01 0	4014586334738	Carbide hole saw for pipes with QuickIN PLUS holder Ø 2"	88,24	20	-
6 31 31 624 01 0	4014586334745	Carbide hole saw for pipes with QuickIN PLUS holder Ø 2-1/16"	88,24	20	-
6 31 31 625 01 0	4014586334752	Carbide hole saw for pipes with QuickIN PLUS holder Ø 2-1/8"	88,24	20	-
6 31 31 626 01 0	4014586366753	Carbide hole saw for pipes with QuickIN PLUS holder	111,43	20	-
6 31 31 627 01 0	4014586366760	Carbide hole saw for pipes with QuickIN PLUS holder	128,14	20	-
6 31 31 628 01 0	4014586366777	Carbide hole saw for pipes with QuickIN PLUS holder	144,86	20	-
6 31 31 629 01 0	4014586366784	Carbide hole saw for pipes with QuickIN PLUS holder	150,42	20	-
6 31 31 630 01 0	4014586366791	Carbide hole saw for pipes with QuickIN PLUS holder	156,00	20	-
6 31 31 631 01 0	4014586366807	Carbide hole saw for pipes with QuickIN PLUS holder	167,14	20	-
6 31 33 119 05 1	4014586611471	HSS-NOVA 25 Annular Cutter Ø 12 x 25 QuickIN	18,26	20	167
6 31 33 119 05 2	4014586611501	HSS-NOVA 50 Annular Cutter Ø 12 x 50 QuickIN	25,63	20	168
6 31 33 120 06 7	4014586615578	HSS-DURA 25 Annular Cutter Ø 12 x 25 QuickIN TIN	26,90	20	169
6 31 33 120 06 8	4014586615639	HSS-DURA 50 Annular Cutter Ø 12 x 50 QuickIN TIN	34,24	20	170
6 31 33 129 05 1	4014586611815	HSS-NOVA 25 Annular Cutter Ø 13 x 25 QuickIN	18,26	20	167
6 31 33 129 05 2	4014586611853	HSS-NOVA 50 Annular Cutter Ø 13 x 50 QuickIN	25,63	20	168
6 31 33 130 06 7	4014586611822	HSS-DURA 25 Annular Cutter Ø 13 x 25 QuickIN TIN	26,90	20	169
6 31 33 130 06 8	4014586611860	HSS-DURA 50 Annular Cutter Ø 13 x 50 QuickIN TIN	34,24	20	170
6 31 33 140 05 1	4014586611891	HSS-NOVA 25 Annular Cutter Ø 14 x 25 QuickIN	18,26	20	167
6 31 33 140 05 2	4014586611938	HSS-NOVA 50 Annular Cutter Ø 14 x 50 QuickIN	25,63	20	168
6 31 33 140 06 7	4014586611907	HSS-DURA 25 Annular Cutter Ø 14 x 25 QuickIN TIN	26,90	20	169
6 31 33 140 06 8	4014586611945	HSS-DURA 50 Annular Cutter Ø 14 x 50 QuickIN TIN	34,24	20	170
6 31 33 150 05 1	4014586612188	HSS-NOVA 25 Annular Cutter Ø 15 x 25 QuickIN	18,26	20	167
6 31 33 150 05 2	4014586612225	HSS-NOVA 50 Annular Cutter Ø 15 x 50 QuickIN	25,63	20	168
6 31 33 150 06 7	4014586612195	HSS-DURA 25 Annular Cutter Ø 15 x 25 QuickIN TIN	26,90	20	169
6 31 33 150 06 8	4014586612232	HSS-DURA 50 Annular Cutter Ø 15 x 50 QuickIN TIN	34,24	20	170
6 31 33 159 05 1	4014586612263	HSS-NOVA 25 Annular Cutter Ø 16 x 25 QuickIN	18,26	20	167
6 31 33 159 05 2	4014586612300	HSS-NOVA 50 Annular Cutter Ø 16 x 50 QuickIN	25,63	20	168
6 31 33 160 06 7	4014586612270	HSS-DURA 25 Annular Cutter Ø 16 x 25 QuickIN TIN	26,90	20	169
6 31 33 160 06 8	4014586612317	HSS-DURA 50 Annular Cutter Ø 16 x 50 QuickIN TIN	34,24	20	170
6 31 33 170 05 1	4014586612485	HSS-NOVA 25 Annular Cutter Ø 17 x 25 QuickIN	19,92	20	167
6 31 33 170 05 2	4014586612522	HSS-NOVA 50 Annular Cutter Ø 17 x 50 QuickIN	27,95	20	168
6 31 33 170 06 7	4014586612492	HSS-DURA 25 Annular Cutter Ø 17 x 25 QuickIN TIN	29,36	20	169
6 31 33 170 06 8	4014586612539	HSS-DURA 50 Annular Cutter Ø 17 x 50 QuickIN TIN	36,71	20	170
6 31 33 180 05 1	4014586612560	HSS-NOVA 25 Annular Cutter Ø 18 x 25 QuickIN	19,92	20	167
6 31 33 180 05 2	4014586612607	HSS-NOVA 50 Annular Cutter Ø 18 x 50 QuickIN	27,95	20	168
6 31 33 180 06 7	4014586612577	HSS-DURA 25 Annular Cutter Ø 18 x 25 QuickIN TIN	29,36	20	169
6 31 33 180 06 8	4014586612614	HSS-DURA 50 Annular Cutter Ø 18 x 50 QuickIN TIN	36,71	20	170
6 31 33 189 05 1	4014586612713	HSS-NOVA 25 Annular Cutter Ø 19 x 25 QuickIN	19,92	20	167
6 31 33 189 05 2	4014586612751	HSS-NOVA 50 Annular Cutter Ø 19 x 50 QuickIN	27,95	20	168
6 31 33 190 06 7	4014586612720	HSS-DURA 25 Annular Cutter Ø 19 x 25 QuickIN TIN	29,36	20	169
6 31 33 190 06 8	4014586612768	HSS-DURA 50 Annular Cutter Ø 19 x 50 QuickIN TIN	36,71	20	170
6 31 33 199 05 2	4014586612904	HSS-NOVA 50 Annular Cutter Ø 20 x 50 QuickIN	32,62	20	168
6 31 33 199 06 3	4014586612874	HSS-NOVA 25 Annular Cutter Ø 20 x 25 QuickIN	23,25	20	167
6 31 33 200 06 7	4014586612867	HSS-DURA 25 Annular Cutter Ø 20 x 25 QuickIN TIN	33,02	20	169



Part number	EAN	Description	Price in €	PC	Page
6 31 33 200 06 8	4014586612911	HSS-DURA 50 Annular Cutter Ø 20 x 50 QuickIN TIN	41,60	20	170
6 31 33 210 05 1	4014586613123	HSS-NOVA 25 Annular Cutter Ø 21 x 25 QuickIN	23,25	20	167
6 31 33 210 05 2	4014586613161	HSS-NOVA 50 Annular Cutter Ø 21 x 50 QuickIN	32,62	20	168
6 31 33 210 06 7	4014586613130	HSS-DURA 25 Annular Cutter Ø 21 x 25 QuickIN TIN	33,02	20	169
6 31 33 210 06 8	4014586613178	HSS-DURA 50 Annular Cutter Ø 21 x 50 QuickIN TIN	41,60	20	170
6 31 33 219 05 1	4014586613215	HSS-NOVA 25 Annular Cutter Ø 22 x 25 QuickIN	23,25	20	167
6 31 33 219 05 2	4014586613253	HSS-NOVA 50 Annular Cutter Ø 22 x 50 QuickIN	32,62	20	168
6 31 33 220 06 7	4014586613222	HSS-DURA 25 Annular Cutter Ø 22 x 25 QuickIN TIN	33,02	20	169
6 31 33 220 06 8	4014586613260	HSS-DURA 50 Annular Cutter Ø 22 x 50 QuickIN TIN	41,60	20	170
6 31 33 229 05 1	4014586613406	HSS-NOVA 25 Annular Cutter Ø 23 x 25 QuickIN	26,58	20	167
6 31 33 229 05 2	4014586613444	HSS-NOVA 50 Annular Cutter Ø 23 x 50 QuickIN	32,62	20	168
6 31 33 230 06 7	4014586613413	HSS-DURA 25 Annular Cutter Ø 23 x 25 QuickIN TIN	40,36	20	169
6 31 33 230 06 8	4014586613451	HSS-DURA 50 Annular Cutter Ø 23 x 50 QuickIN TIN	48,93	20	170
6 31 33 240 05 1	4014586613499	HSS-NOVA 25 Annular Cutter Ø 24 x 25 QuickIN	26,58	20	167
6 31 33 240 05 2	4014586613536	HSS-NOVA 50 Annular Cutter Ø 24 x 50 QuickIN	34,95	20	168
6 31 33 240 06 7	4014586613505	HSS-DURA 25 Annular Cutter Ø 24 x 25 QuickIN TIN	40,36	20	169
6 31 33 240 06 8	4014586613543	HSS-DURA 50 Annular Cutter Ø 24 x 50 QuickIN TIN	48,93	20	170
6 31 33 250 05 1	4014586613635	HSS-NOVA 25 Annular Cutter Ø 25 x 25 QuickIN	26,58	20	167
6 31 33 250 05 2	4014586613673	HSS-NOVA 50 Annular Cutter Ø 25 x 50 QuickIN	39,62	20	168
6 31 33 250 06 7	4014586613642	HSS-DURA 25 Annular Cutter Ø 25 x 25 QuickIN TIN	40,36	20	169
6 31 33 250 06 8	4014586613680	HSS-DURA 50 Annular Cutter Ø 25 x 50 QuickIN TIN	48,93	20	170
6 31 33 259 05 1	4014586613727	HSS-NOVA 25 Annular Cutter Ø 26 x 25 QuickIN	31,00	20	167
6 31 33 259 05 2	4014586613765	HSS-NOVA 50 Annular Cutter Ø 26 x 50 QuickIN	39,62	20	168
6 31 33 260 06 7	4014586613734	HSS-DURA 25 Annular Cutter Ø 26 x 25 QuickIN TIN	44,04	20	169
6 31 33 260 06 8	4014586613772	HSS-DURA 50 Annular Cutter Ø 26 x 50 QuickIN TIN	55,05	20	170
6 31 33 270 05 1	4014586613819	HSS-NOVA 25 Annular Cutter Ø 27 x 25 QuickIN	31,00	20	167
6 31 33 270 05 2	4014586613857	HSS-NOVA 50 Annular Cutter Ø 27 x 50 QuickIN	39,62	20	168
6 31 33 270 06 7	4014586613826	HSS-DURA 25 Annular Cutter Ø 27 x 25 QuickIN TIN	44,04	20	169
6 31 33 270 06 8	4014586613864	HSS-DURA 50 Annular Cutter Ø 27 x 50 QuickIN TIN	55,05	20	170
6 31 33 279 05 1	4014586613901	HSS-NOVA 25 Annular Cutter Ø 28 x 25 QuickIN	33,21	20	167
6 31 33 279 05 2	4014586613949	HSS-NOVA 50 Annular Cutter Ø 28 x 50 QuickIN	46,60	20	168
6 31 33 280 06 7	4014586613918	HSS-DURA 25 Annular Cutter Ø 28 x 25 QuickIN TIN	47,70	20	169
6 31 33 280 06 8	4014586613956	HSS-DURA 50 Annular Cutter Ø 28 x 50 QuickIN TIN	59,94	20	170
6 31 33 285 05 1	4014586611198	HSS-NOVA 1" Annular Cutter Ø 1-1/8" x 1" QuickIN	38,73	20	-
6 31 33 289 05 1	4014586613994	HSS-NOVA 25 Annular Cutter Ø 29 x 25 QuickIN	33,21	20	167
6 31 33 289 05 2	4014586614038	HSS-NOVA 50 Annular Cutter Ø 29 x 50 QuickIN	46,60	20	168
6 31 33 290 06 7	4014586614007	HSS-DURA 25 Annular Cutter Ø 29 x 25 QuickIN TIN	47,70	20	169
6 31 33 290 06 8	4014586614045	HSS-DURA 50 Annular Cutter Ø 29 x 50 QuickIN TIN	59,94	20	170
6 31 33 299 05 1	4014586614229	HSS-NOVA 25 Annular Cutter Ø 30 x 25 QuickIN	35,43	20	167
6 31 33 299 05 2	4014586614267	HSS-NOVA 50 Annular Cutter Ø 30 x 50 QuickIN	46,60	20	168
6 31 33 300 06 7	4014586614236	HSS-DURA 25 Annular Cutter Ø 30 x 25 QuickIN TIN	52,59	20	169
6 31 33 300 06 8	4014586614274	HSS-DURA 50 Annular Cutter Ø 30 x 50 QuickIN TIN	66,06	20	170
6 31 33 309 05 1	4014586614311	HSS-NOVA 25 Annular Cutter Ø 31 x 25 QuickIN	35,43	20	167
6 31 33 309 05 2	4014586614359	HSS-NOVA 50 Annular Cutter Ø 31 x 50 QuickIN	52,43	20	168
6 31 33 310 06 7	4014586614328	HSS-DURA 25 Annular Cutter Ø 31 x 25 QuickIN TIN	52,59	20	169
6 31 33 310 06 8	4014586614366	HSS-DURA 50 Annular Cutter Ø 31 x 50 QuickIN TIN	66,06	20	170
6 31 33 319 05 1	4014586614397	HSS-NOVA 25 Annular Cutter Ø 32 x 25 QuickIN	40,95	20	167
6 31 33 319 05 2	4014586614434	HSS-NOVA 50 Annular Cutter Ø 32 x 50 QuickIN	52,43	20	168
6 31 33 320 06 7	4014586614403	HSS-DURA 25 Annular Cutter Ø 32 x 25 QuickIN TIN	59,94	20	169
6 31 33 320 06 8	4014586614441	HSS-DURA 50 Annular Cutter Ø 32 x 50 QuickIN TIN	74,62	20	170
6 31 33 329 05 1	4014586614489	HSS-NOVA 25 Annular Cutter Ø 33 x 25 QuickIN	40,95	20	167
6 31 33 329 05 2	4014586614526	HSS-NOVA 50 Annular Cutter Ø 33 x 50 QuickIN	58,26	20	168
6 31 33 330 06 7	4014586614496	HSS-DURA 25 Annular Cutter Ø 33 x 25 QuickIN TIN	59,94	20	169
6 31 33 330 06 8	4014586614533	HSS-DURA 50 Annular Cutter Ø 33 x 50 QuickIN TIN	74,62	20	170
6 31 33 339 05 1	4014586614564	HSS-NOVA 25 Annular Cutter Ø 34 x 25 QuickIN	46,47	20	167
6 31 33 339 05 2	4014586614601	HSS-NOVA 50 Annular Cutter Ø 34 x 50 QuickIN	58,26	20	168
6 31 33 340 06 7	4014586614571	HSS-DURA 25 Annular Cutter Ø 34 x 25 QuickIN TIN	66,06	20	169
6 31 33 340 06 8	4014586614618	HSS-DURA 50 Annular Cutter Ø 34 x 50 QuickIN TIN	83,16	20	170
6 31 33 350 05 1	4014586614649	HSS-NOVA 25 Annular Cutter Ø 35 x 25 QuickIN	46,47	20	167
6 31 33 350 05 2	4014586614687	HSS-NOVA 50 Annular Cutter Ø 35 x 50 QuickIN	58,26	20	168
6 31 33 350 06 7	4014586614656	HSS-DURA 25 Annular Cutter Ø 35 x 25 QuickIN TIN	66,06	20	169
6 31 33 350 06 8	4014586614694	HSS-DURA 50 Annular Cutter Ø 35 x 50 QuickIN TIN	83,16	20	170
6 31 33 359 05 1	4014586614731	HSS-NOVA 25 Annular Cutter Ø 36 x 25 QuickIN	46,47	20	167
6 31 33 359 05 2	4014586614779	HSS-NOVA 50 Annular Cutter Ø 36 x 50 QuickIN	66,40	20	168
6 31 33 360 06 7	4014586614748	HSS-DURA 25 Annular Cutter Ø 36 x 25 QuickIN TIN	66,06	20	169
6 31 33 360 06 8	4014586614786	HSS-DURA 50 Annular Cutter Ø 36 x 50 QuickIN TIN	83,16	20	170
6 31 33 369 05 1	4014586614823	HSS-NOVA 25 Annular Cutter Ø 37 x 25 QuickIN	54,22	20	167
6 31 33 369 05 2	4014586614861	HSS-NOVA 50 Annular Cutter Ø 37 x 50 QuickIN	66,40	20	168
6 31 33 370 06 7	4014586614830	HSS-DURA 25 Annular Cutter Ø 37 x 25 QuickIN TIN	74,62	20	169
6 31 33 370 06 8	4014586614878	HSS-DURA 50 Annular Cutter Ø 37 x 50 QuickIN TIN	92,97	20	170
6 31 33 379 05 1	4014586614908	HSS-NOVA 25 Annular Cutter Ø 38 x 25 QuickIN	54,22	20	168
6 31 33 379 05 2	4014586614946	HSS-NOVA 50 Annular Cutter Ø 38 x 50 QuickIN	66,40	20	168
6 31 33 380 06 7	4014586614915	HSS-DURA 25 Annular Cutter Ø 38 x 25 QuickIN TIN	74,62	20	169
6 31 33 380 06 8	4014586614953	HSS-DURA 50 Annular Cutter Ø 38 x 50 QuickIN TIN	92,97	20	170
6 31 33 389 05 1	4014586614984	HSS-NOVA 25 Annular Cutter Ø 39 x 25 QuickIN	54,22	20	168
6 31 33 389 05 2	4014586615028	HSS-NOVA 50 Annular Cutter Ø 39 x 50 QuickIN	75,73	20	168

Accessories in numerical order

Part number	EAN	Description	Price in €	PC	Page
6 31 33 390 06 7	4014586614991	HSS-DURA 25 Annular Cutter Ø 39 x 25 QuickIN TIN	74,62	20	169
6 31 33 390 06 8	4014586615035	HSS-DURA 50 Annular Cutter Ø 39 x 50 QuickIN TIN	92,97	20	170
6 31 33 399 05 1	4014586615066	HSS-NOVA 25 Annular Cutter Ø 40 x 25 QuickIN	60,87	20	168
6 31 33 399 05 2	4014586615103	HSS-NOVA 50 Annular Cutter Ø 40 x 50 QuickIN	75,73	20	168
6 31 33 400 06 7	4014586615073	HSS-DURA 25 Annular Cutter Ø 40 x 25 QuickIN TIN	83,16	20	169
6 31 33 400 06 8	4014586615110	HSS-DURA 50 Annular Cutter Ø 40 x 50 QuickIN TIN	103,97	20	170
6 31 33 409 05 1	4014586615158	HSS-NOVA 25 Annular Cutter Ø 41 x 25 QuickIN	60,87	20	168
6 31 33 409 05 2	4014586615196	HSS-NOVA 50 Annular Cutter Ø 41 x 25 QuickIN	81,54	20	168
6 31 33 410 06 7	4014586615165	HSS-DURA 25 Annular Cutter Ø 41 x 25 QuickIN TIN	83,16	20	169
6 31 33 410 06 8	4014586615202	HSS-DURA 50 Annular Cutter Ø 41 x 50 QuickIN TIN	103,97	20	170
6 31 33 420 05 1	4014586615233	HSS-NOVA 25 Annular Cutter Ø 42 x 25 QuickIN	66,40	20	168
6 31 33 420 05 2	4014586615271	HSS-NOVA 50 Annular Cutter Ø 42 x 50 QuickIN	88,54	20	168
6 31 33 420 06 7	4014586615240	HSS-DURA 25 Annular Cutter Ø 42 x 25 QuickIN TIN	90,52	20	169
6 31 33 420 06 8	4014586615288	HSS-DURA 50 Annular Cutter Ø 42 x 50 QuickIN TIN	113,75	20	170
6 31 33 429 05 1	4014586615318	HSS-NOVA 25 Annular Cutter Ø 43 x 25 QuickIN	66,40	20	168
6 31 33 429 05 2	4014586615356	HSS-NOVA 50 Annular Cutter Ø 43 x 50 QuickIN	88,54	20	168
6 31 33 430 06 7	4014586615325	HSS-DURA 25 Annular Cutter Ø 43 x 25 QuickIN TIN	90,52	20	169
6 31 33 430 06 8	4014586615363	HSS-DURA 50 Annular Cutter Ø 43 x 50 QuickIN TIN	113,75	20	170
6 31 33 439 05 1	4014586615394	HSS-NOVA 25 Annular Cutter Ø 44 x 25 QuickIN	69,73	20	168
6 31 33 439 05 2	4014586615431	HSS-NOVA 50 Annular Cutter Ø 44 x 50 QuickIN	88,54	20	168
6 31 33 440 06 7	4014586615400	HSS-DURA 25 Annular Cutter Ø 44 x 25 QuickIN TIN	96,62	20	169
6 31 33 440 06 8	4014586615448	HSS-DURA 50 Annular Cutter Ø 44 x 50 QuickIN TIN	122,33	20	170
6 31 33 449 05 1	4014586615479	HSS-NOVA 25 Annular Cutter Ø 45 x 25 QuickIN	69,73	20	168
6 31 33 449 05 2	4014586615516	HSS-NOVA 50 Annular Cutter Ø 45 x 50 QuickIN	93,20	20	168
6 31 33 450 06 7	4014586615486	HSS-DURA 25 Annular Cutter Ø 45 x 25 QuickIN TIN	96,62	20	169
6 31 33 450 06 8	4014586615523	HSS-DURA 50 Annular Cutter Ø 45 x 50 QuickIN TIN	122,33	20	170
6 31 33 459 05 1	4014586615561	HSS-NOVA 25 Annular Cutter Ø 46 x 25 QuickIN	79,70	20	168
6 31 33 459 05 2	4014586615622	HSS-NOVA 50 Annular Cutter Ø 46 x 50 QuickIN	102,51	20	168
6 31 33 460 06 7	4014586615585	HSS-DURA 25 Annular Cutter Ø 46 x 25 QuickIN TIN	107,64	20	169
6 31 33 460 06 8	4014586615646	HSS-DURA 50 Annular Cutter Ø 46 x 50 QuickIN TIN	137,01	20	170
6 31 33 469 05 1	4014586615684	HSS-NOVA 25 Annular Cutter Ø 47 x 25 QuickIN	79,70	20	168
6 31 33 469 05 2	4014586615721	HSS-NOVA 50 Annular Cutter Ø 47 x 50 QuickIN	102,51	20	168
6 31 33 470 06 7	4014586615691	HSS-DURA 25 Annular Cutter Ø 47 x 25 QuickIN TIN	107,64	20	169
6 31 33 470 06 8	4014586615738	HSS-DURA 50 Annular Cutter Ø 47 x 50 QuickIN TIN	137,01	20	170
6 31 33 479 05 1	4014586615769	HSS-NOVA 25 Annular Cutter Ø 48 x 25 QuickIN	83,00	20	168
6 31 33 479 05 2	4014586615806	HSS-NOVA 50 Annular Cutter Ø 48 x 50 QuickIN	107,17	20	168
6 31 33 480 06 7	4014586615776	HSS-DURA 25 Annular Cutter Ø 48 x 25 QuickIN TIN	117,43	20	169
6 31 33 480 06 8	4014586615813	HSS-DURA 50 Annular Cutter Ø 48 x 50 QuickIN TIN	146,78	20	170
6 31 33 489 05 1	4014586615844	HSS-NOVA 25 Annular Cutter Ø 49 x 25 QuickIN	83,00	20	168
6 31 33 489 05 2	4014586615882	HSS-NOVA 50 Annular Cutter Ø 49 x 50 QuickIN	107,17	20	168
6 31 33 490 06 7	4014586615851	HSS-DURA 25 Annular Cutter Ø 49 x 25 QuickIN TIN	117,43	20	169
6 31 33 490 06 8	4014586615899	HSS-DURA 50 Annular Cutter Ø 49 x 50 QuickIN TIN	146,78	20	170
6 31 33 499 05 1	4014586615981	HSS-NOVA 25 Annular Cutter Ø 50 x 25 QuickIN	83,00	20	168
6 31 33 499 05 2	4014586616018	HSS-NOVA 50 Annular Cutter Ø 50 x 50 QuickIN	110,68	20	168
6 31 33 500 06 7	4014586615592	HSS-DURA 25 Annular Cutter Ø 50 x 25 QuickIN TIN	117,43	20	169
6 31 33 500 06 8	4014586615653	HSS-DURA 50 Annular Cutter Ø 50 x 50 QuickIN TIN	146,78	20	170
6 31 33 999 01 0	4014586375571	Best of core bits HSS NOVA 50 QI 12,14,16,18,20,22 mm accessory set	166,03	20	167
6 31 34 120 05 1	4014586611457	HSS-NOVA 25 Annular Cutter Ø 12 x 25 Weldon	18,26	20	154
6 31 34 120 05 2	4014586611488	HSS-NOVA 50 Annular Cutter Ø 12 x 50 Weldon	25,63	20	154
6 31 34 120 07 5	4014586611464	HSS-DURA 25 Annular Cutter Ø 12 x 25 Weldon TIN	26,90	20	155
6 31 34 120 07 6	4014586611495	HSS-DURA 50 Annular Cutter Ø 12 x 50 Weldon TIN	34,24	20	156
6 31 34 130 05 1	4014586611792	HSS-NOVA 25 Annular Cutter Ø 13 x 25 Weldon	18,26	20	154
6 31 34 130 05 2	4014586611839	HSS-NOVA 50 Annular Cutter Ø 13 x 50 Weldon	25,63	20	154
6 31 34 130 07 5	4014586611808	HSS-DURA 25 Annular Cutter Ø 13 x 25 Weldon TIN	26,90	20	155
6 31 34 130 07 6	4014586611846	HSS-DURA 50 Annular Cutter Ø 13 x 50 Weldon TIN	34,24	20	156
6 31 34 140 05 1	4014586611877	HSS-NOVA 25 Annular Cutter Ø 14 x 25 Weldon	18,26	20	154
6 31 34 140 05 2	4014586611914	HSS-NOVA 50 Annular Cutter Ø 14 x 50 Weldon	25,63	20	154
6 31 34 140 07 5	4014586611884	HSS-DURA 25 Annular Cutter Ø 14 x 25 Weldon TIN	26,90	20	155
6 31 34 140 07 6	4014586611921	HSS-DURA 50 Annular Cutter Ø 14 x 50 Weldon TIN	34,24	20	156
6 31 34 150 05 1	4014586612164	HSS-NOVA 25 Annular Cutter Ø 15 x 25 Weldon	18,26	20	154
6 31 34 150 05 2	4014586612201	HSS-NOVA 50 Annular Cutter Ø 15 x 50 Weldon	25,63	20	154
6 31 34 150 07 5	4014586612171	HSS-DURA 25 Annular Cutter Ø 15 x 25 Weldon TIN	26,90	20	155
6 31 34 150 07 6	4014586612218	HSS-DURA 50 Annular Cutter Ø 15 x 50 Weldon TIN	34,24	20	156
6 31 34 160 05 1	4014586612249	HSS-NOVA 25 Annular Cutter Ø 16 x 25 Weldon	18,26	20	154
6 31 34 160 05 2	4014586612287	HSS-NOVA 50 Annular Cutter Ø 16 x 50 Weldon	25,63	20	154
6 31 34 160 07 5	4014586612256	HSS-DURA 25 Annular Cutter Ø 16 x 25 Weldon TIN	26,90	20	155
6 31 34 160 07 6	4014586612294	HSS-DURA 50 Annular Cutter Ø 16 x 50 Weldon TIN	34,24	20	156
6 31 34 170 05 1	4014586612461	HSS-NOVA 25 Annular Cutter Ø 17 x 25 Weldon	19,92	20	154
6 31 34 170 05 2	4014586612508	HSS-NOVA 50 Annular Cutter Ø 17 x 50 Weldon	27,95	20	154
6 31 34 170 07 5	4014586612478	HSS-DURA 25 Annular Cutter Ø 17 x 25 Weldon TIN	29,36	20	155
6 31 34 170 07 6	4014586612515	HSS-DURA 50 Annular Cutter Ø 17 x 50 Weldon TIN	36,71	20	156
6 31 34 180 05 1	4014586612546	HSS-NOVA 25 Annular Cutter Ø 18 x 25 Weldon	19,92	20	154
6 31 34 180 05 2	4014586612584	HSS-NOVA 50 Annular Cutter Ø 18 x 50 Weldon	27,95	20	154
6 31 34 180 07 5	4014586612553	HSS-DURA 25 Annular Cutter Ø 18 x 25 Weldon TIN	29,36	20	155
6 31 34 180 07 6	4014586612591	HSS-DURA 50 Annular Cutter Ø 18 x 50 Weldon TIN	36,71	20	156
6 31 34 190 05 1	4014586612690	HSS-NOVA 25 Annular Cutter Ø 19 x 25 Weldon	19,92	20	154





Part number	EAN	Description	Price in €	PC	Page
6 31 34 190 05 2	4014586612737	HSS-NOVA 50 Annular Cutter Ø 19 x 50 Weldon	27,95	20	154
6 31 34 190 05 3	4014586612775	HSS-NOVA 75 Annular Cutter Ø 19 x 75 Weldon	60,01	20	155
6 31 34 190 07 5	4014586612706	HSS-DURA 25 Annular Cutter Ø 19 x 25 Weldon TIN	29,36	20	155
6 31 34 190 07 6	4014586612744	HSS-DURA 50 Annular Cutter Ø 19 x 50 Weldon TIN	36,71	20	156
6 31 34 200 05 1	4014586612843	HSS-NOVA 25 Annular Cutter Ø 20 x 25 Weldon	23,25	20	154
6 31 34 200 05 2	4014586612881	HSS-NOVA 50 Annular Cutter Ø 20 x 50 Weldon	32,62	20	154
6 31 34 200 05 3	4014586612928	HSS-NOVA 75 Annular Cutter Ø 20 x 75 Weldon	60,01	20	155
6 31 34 200 07 5	4014586612850	HSS-DURA 25 Annular Cutter Ø 20 x 25 Weldon TIN	33,02	20	155
6 31 34 200 07 6	4014586612898	HSS-DURA 50 Annular Cutter Ø 20 x 50 Weldon TIN	41,60	20	156
6 31 34 210 05 1	4014586613109	HSS-NOVA 25 Annular Cutter Ø 21 x 25 Weldon	23,25	20	154
6 31 34 210 05 2	4014586613147	HSS-NOVA 50 Annular Cutter Ø 21 x 50 Weldon	32,62	20	154
6 31 34 210 05 3	4014586613185	HSS-NOVA 75 Annular Cutter Ø 21 x 75 Weldon	64,80	20	155
6 31 34 210 07 5	4014586613116	HSS-DURA 25 Annular Cutter Ø 21 x 25 Weldon TIN	33,02	20	155
6 31 34 210 07 6	4014586613154	HSS-DURA 50 Annular Cutter Ø 21 x 50 Weldon TIN	41,60	20	156
6 31 34 220 05 1	4014586613192	HSS-NOVA 25 Annular Cutter Ø 22 x 25 Weldon	23,25	20	154
6 31 34 220 05 2	4014586613239	HSS-NOVA 50 Annular Cutter Ø 22 x 50 Weldon	32,62	20	154
6 31 34 220 05 3	4014586613277	HSS-NOVA 75 Annular Cutter Ø 22 x 75 Weldon	64,80	20	155
6 31 34 220 07 5	4014586613208	HSS-DURA 25 Annular Cutter Ø 22 x 25 Weldon TIN	33,02	20	155
6 31 34 220 07 6	4014586613246	HSS-DURA 50 Annular Cutter Ø 22 x 50 Weldon TIN	41,60	20	156
6 31 34 230 05 1	4014586613383	HSS-NOVA 25 Annular Cutter Ø 23 x 25 Weldon	26,58	20	154
6 31 34 230 05 2	4014586613420	HSS-NOVA 50 Annular Cutter Ø 23 x 50 Weldon	32,62	20	154
6 31 34 230 05 3	4014586613468	HSS-NOVA 75 Annular Cutter Ø 23 x 75 Weldon	64,80	20	155
6 31 34 230 07 5	4014586613390	HSS-DURA 25 Annular Cutter Ø 23 x 25 Weldon TIN	40,36	20	155
6 31 34 230 07 6	4014586613437	HSS-DURA 50 Annular Cutter Ø 23 x 50 Weldon TIN	48,93	20	156
6 31 34 240 05 1	4014586613475	HSS-NOVA 25 Annular Cutter Ø 24 x 25 Weldon	26,58	20	154
6 31 34 240 05 2	4014586613512	HSS-NOVA 50 Annular Cutter Ø 24 x 50 Weldon	34,95	20	154
6 31 34 240 05 3	4014586613550	HSS-NOVA 75 Annular Cutter Ø 24 x 75 Weldon	64,80	20	155
6 31 34 240 07 5	4014586613482	HSS-DURA 25 Annular Cutter Ø 24 x 25 Weldon TIN	40,36	20	155
6 31 34 240 07 6	4014586613529	HSS-DURA 50 Annular Cutter Ø 24 x 50 Weldon TIN	48,93	20	156
6 31 34 250 05 1	4014586613611	HSS-NOVA 25 Annular Cutter Ø 25 x 25 Weldon	26,58	20	154
6 31 34 250 05 2	4014586613659	HSS-NOVA 50 Annular Cutter Ø 25 x 50 Weldon	39,62	20	154
6 31 34 250 05 3	4014586613697	HSS-NOVA 75 Annular Cutter Ø 25 x 75 Weldon	75,60	20	155
6 31 34 250 07 5	4014586613628	HSS-DURA 25 Annular Cutter Ø 25 x 25 Weldon TIN	40,36	20	155
6 31 34 250 07 6	4014586613666	HSS-DURA 50 Annular Cutter Ø 25 x 50 Weldon TIN	48,93	20	156
6 31 34 260 05 1	4014586613703	HSS-NOVA 25 Annular Cutter Ø 26 x 25 Weldon	31,00	20	154
6 31 34 260 05 2	4014586613741	HSS-NOVA 50 Annular Cutter Ø 26 x 50 Weldon	39,62	20	154
6 31 34 260 05 3	4014586613789	HSS-NOVA 75 Annular Cutter Ø 26 x 75 Weldon	75,60	20	155
6 31 34 260 07 5	4014586613710	HSS-DURA 25 Annular Cutter Ø 26 x 25 Weldon TIN	44,04	20	155
6 31 34 260 07 6	4014586613758	HSS-DURA 50 Annular Cutter Ø 26 x 50 Weldon TIN	55,05	20	156
6 31 34 270 05 1	4014586613796	HSS-NOVA 25 Annular Cutter Ø 27 x 25 Weldon	31,00	20	154
6 31 34 270 05 2	4014586613833	HSS-NOVA 50 Annular Cutter Ø 27 x 50 Weldon	39,62	20	154
6 31 34 270 05 3	4014586613871	HSS-NOVA 75 Annular Cutter Ø 27 x 75 Weldon	75,60	20	155
6 31 34 270 07 5	4014586613802	HSS-DURA 25 Annular Cutter Ø 27 x 25 Weldon TIN	44,04	20	155
6 31 34 270 07 6	4014586613840	HSS-DURA 50 Annular Cutter Ø 27 x 50 Weldon TIN	55,05	20	156
6 31 34 280 05 1	4014586613888	HSS-NOVA 25 Annular Cutter Ø 28 x 25 Weldon	33,21	20	154
6 31 34 280 05 2	4014586613925	HSS-NOVA 50 Annular Cutter Ø 28 x 50 Weldon	46,60	20	154
6 31 34 280 05 3	4014586613963	HSS-NOVA 75 Annular Cutter Ø 28 x 75 Weldon	84,01	20	155
6 31 34 280 07 5	4014586613895	HSS-DURA 25 Annular Cutter Ø 28 x 25 Weldon TIN	47,70	20	155
6 31 34 280 07 6	4014586613932	HSS-DURA 50 Annular Cutter Ø 28 x 50 Weldon TIN	59,94	20	156
6 31 34 290 05 1	4014586613970	HSS-NOVA 25 Annular Cutter Ø 29 x 25 Weldon	33,21	20	154
6 31 34 290 05 2	4014586614014	HSS-NOVA 50 Annular Cutter Ø 29 x 50 Weldon	46,60	20	154
6 31 34 290 05 3	4014586614052	HSS-NOVA 75 Annular Cutter Ø 29 x 75 Weldon	84,01	20	155
6 31 34 290 07 5	4014586613987	HSS-DURA 25 Annular Cutter Ø 29 x 25 Weldon TIN	47,70	20	155
6 31 34 290 07 6	4014586614021	HSS-DURA 50 Annular Cutter Ø 29 x 50 Weldon TIN	59,94	20	156
6 31 34 300 05 1	4014586614205	HSS-NOVA 25 Annular Cutter Ø 30 x 25 Weldon	35,43	20	154
6 31 34 300 05 2	4014586614243	HSS-NOVA 50 Annular Cutter Ø 30 x 50 Weldon	46,60	20	154
6 31 34 300 05 3	4014586614281	HSS-NOVA 75 Annular Cutter Ø 30 x 75 Weldon	97,20	20	155
6 31 34 300 07 5	4014586614212	HSS-DURA 25 Annular Cutter Ø 30 x 25 Weldon TIN	52,59	20	155
6 31 34 300 07 6	4014586614250	HSS-DURA 50 Annular Cutter Ø 30 x 50 Weldon TIN	66,06	20	156
6 31 34 310 05 1	4014586614298	HSS-NOVA 25 Annular Cutter Ø 31 x 25 Weldon	35,43	20	154
6 31 34 310 05 2	4014586614335	HSS-NOVA 50 Annular Cutter Ø 31 x 50 Weldon	52,43	20	154
6 31 34 310 07 5	4014586614304	HSS-DURA 25 Annular Cutter Ø 31 x 25 Weldon TIN	52,59	20	155
6 31 34 310 07 6	4014586614342	HSS-DURA 50 Annular Cutter Ø 31 x 50 Weldon TIN	66,06	20	156
6 31 34 320 05 1	4014586614373	HSS-NOVA 25 Annular Cutter Ø 32 x 25 Weldon	40,95	20	154
6 31 34 320 05 2	4014586614410	HSS-NOVA 50 Annular Cutter Ø 32 x 50 Weldon	52,43	20	154
6 31 34 320 05 3	4014586614458	HSS-NOVA 75 Annular Cutter Ø 32 x 75 Weldon	97,20	20	155
6 31 34 320 07 5	4014586614380	HSS-DURA 25 Annular Cutter Ø 32 x 25 Weldon TIN	59,94	20	155
6 31 34 320 07 6	4014586614427	HSS-DURA 50 Annular Cutter Ø 32 x 50 Weldon TIN	74,62	20	156
6 31 34 330 05 1	4014586614465	HSS-NOVA 25 Annular Cutter Ø 33 x 25 Weldon	40,95	20	154
6 31 34 330 05 2	4014586614502	HSS-NOVA 50 Annular Cutter Ø 33 x 50 Weldon	58,26	20	154
6 31 34 330 07 5	4014586614472	HSS-DURA 25 Annular Cutter Ø 33 x 25 Weldon TIN	59,94	20	155
6 31 34 330 07 6	4014586614519	HSS-DURA 50 Annular Cutter Ø 33 x 50 Weldon TIN	74,62	20	156
6 31 34 340 05 1	4014586614540	HSS-NOVA 25 Annular Cutter Ø 34 x 25 Weldon	46,47	20	154
6 31 34 340 05 2	4014586614588	HSS-NOVA 50 Annular Cutter Ø 34 x 50 Weldon	58,26	20	154
6 31 34 340 07 5	4014586614557	HSS-DURA 25 Annular Cutter Ø 34 x 25 Weldon TIN	66,06	20	155
6 31 34 340 07 6	4014586614595	HSS-DURA 50 Annular Cutter Ø 34 x 50 Weldon TIN	83,16	20	156

Part number	EAN	Description	Price in €	PC	Page
6 31 34 350 05 1	4014586614625	HSS-NOVA 25 Annular Cutter Ø 35 x 25 Weldon	46,47	20	154
6 31 34 350 05 2	4014586614663	HSS-NOVA 50 Annular Cutter Ø 35 x 50 Weldon	58,26	20	154
6 31 34 350 05 3	4014586614700	HSS-NOVA 75 Annular Cutter Ø 35 x 75 Weldon	104,39	20	155
6 31 34 350 07 5	4014586614632	HSS-DURA 25 Annular Cutter Ø 35 x 25 Weldon TIN	66,06	20	155
6 31 34 350 07 6	4014586614670	HSS-DURA 50 Annular Cutter Ø 35 x 50 Weldon TIN	83,16	20	156
6 31 34 360 05 1	4014586614717	HSS-NOVA 25 Annular Cutter Ø 36 x 25 Weldon	46,47	20	154
6 31 34 360 05 2	4014586614755	HSS-NOVA 50 Annular Cutter Ø 36 x 50 Weldon	66,40	20	154
6 31 34 360 05 3	4014586614793	HSS-NOVA 75 Annular Cutter Ø 36 x 75 Weldon	112,80	20	155
6 31 34 360 07 5	4014586614724	HSS-DURA 25 Annular Cutter Ø 36 x 25 Weldon TIN	66,06	20	155
6 31 34 360 07 6	4014586614762	HSS-DURA 50 Annular Cutter Ø 36 x 50 Weldon TIN	83,16	20	156
6 31 34 370 05 1	4014586614809	HSS-NOVA 25 Annular Cutter Ø 37 x 25 Weldon	54,22	20	154
6 31 34 370 05 2	4014586614847	HSS-NOVA 50 Annular Cutter Ø 37 x 50 Weldon	66,40	20	154
6 31 34 370 07 5	4014586614816	HSS-DURA 25 Annular Cutter Ø 37 x 25 Weldon TIN	74,62	20	155
6 31 34 370 07 6	4014586614854	HSS-DURA 50 Annular Cutter Ø 37 x 50 Weldon TIN	92,97	20	156
6 31 34 380 05 1	4014586614885	HSS-NOVA 25 Annular Cutter Ø 38 x 25 Weldon	54,22	20	154
6 31 34 380 05 2	4014586614922	HSS-NOVA 50 Annular Cutter Ø 38 x 50 Weldon	66,40	20	155
6 31 34 380 07 5	4014586614892	HSS-DURA 25 Annular Cutter Ø 38 x 25 Weldon TIN	74,62	20	155
6 31 34 380 07 6	4014586614939	HSS-DURA 50 Annular Cutter Ø 38 x 50 Weldon TIN	92,97	20	156
6 31 34 390 05 1	4014586614960	HSS-NOVA 25 Annular Cutter Ø 39 x 25 Weldon	54,22	20	154
6 31 34 390 05 2	4014586615004	HSS-NOVA 50 Annular Cutter Ø 39 x 50 Weldon	75,73	20	155
6 31 34 390 07 5	4014586614977	HSS-DURA 25 Annular Cutter Ø 39 x 25 Weldon TIN	74,62	20	155
6 31 34 390 07 6	4014586615011	HSS-DURA 50 Annular Cutter Ø 39 x 50 Weldon TIN	92,97	20	156
6 31 34 400 05 1	4014586615042	HSS-NOVA 25 Annular Cutter Ø 40 x 25 Weldon	60,87	20	154
6 31 34 400 05 2	4014586615080	HSS-NOVA 50 Annular Cutter Ø 40 x 50 Weldon	75,73	20	155
6 31 34 400 05 3	4014586615127	HSS-NOVA 75 Annular Cutter Ø 40 x 75 Weldon	138,00	20	155
6 31 34 400 07 5	4014586615059	HSS-DURA 25 Annular Cutter Ø 40 x 25 Weldon TIN	83,16	20	155
6 31 34 400 07 6	4014586615097	HSS-DURA 50 Annular Cutter Ø 40 x 50 Weldon TIN	103,97	20	156
6 31 34 410 05 1	4014586615134	HSS-NOVA 25 Annular Cutter Ø 41 x 25 Weldon	60,87	20	154
6 31 34 410 05 2	4014586615172	HSS-NOVA 50 Annular Cutter Ø 41 x 50 Weldon	81,54	20	155
6 31 34 410 07 5	4014586615141	HSS-DURA 25 Annular Cutter Ø 41 x 25 Weldon TIN	83,16	20	155
6 31 34 410 07 6	4014586615189	HSS-DURA 50 Annular Cutter Ø 41 x 50 Weldon TIN	103,97	20	156
6 31 34 420 05 1	4014586615219	HSS-NOVA 25 Annular Cutter Ø 42 x 25 Weldon	66,40	20	154
6 31 34 420 05 2	4014586615257	HSS-NOVA 50 Annular Cutter Ø 42 x 50 Weldon	88,54	20	155
6 31 34 420 07 5	4014586615226	HSS-DURA 25 Annular Cutter Ø 42 x 25 Weldon TIN	90,52	20	155
6 31 34 420 07 6	4014586615264	HSS-DURA 50 Annular Cutter Ø 42 x 50 Weldon TIN	113,75	20	156
6 31 34 430 05 1	4014586615295	HSS-NOVA 25 Annular Cutter Ø 43 x 25 Weldon	66,40	20	154
6 31 34 430 05 2	4014586615332	HSS-NOVA 50 Annular Cutter Ø 43 x 50 Weldon	88,54	20	155
6 31 34 430 07 5	4014586615301	HSS-DURA 25 Annular Cutter Ø 43 x 25 Weldon TIN	90,52	20	155
6 31 34 430 07 6	4014586615349	HSS-DURA 50 Annular Cutter Ø 43 x 50 Weldon TIN	113,75	20	156
6 31 34 440 05 1	4014586615370	HSS-NOVA 25 Annular Cutter Ø 44 x 25 Weldon	69,73	20	154
6 31 34 440 05 2	4014586615417	HSS-NOVA 50 Annular Cutter Ø 44 x 50 Weldon	88,54	20	155
6 31 34 440 07 5	4014586615387	HSS-DURA 25 Annular Cutter Ø 44 x 25 Weldon TIN	96,62	20	155
6 31 34 440 07 6	4014586615424	HSS-DURA 50 Annular Cutter Ø 44 x 50 Weldon TIN	122,33	20	156
6 31 34 450 05 1	4014586615455	HSS-NOVA 25 Annular Cutter Ø 45 x 25 Weldon	69,73	20	154
6 31 34 450 05 2	4014586615493	HSS-NOVA 50 Annular Cutter Ø 45 x 50 Weldon	93,20	20	155
6 31 34 450 05 3	4014586615530	HSS-NOVA 75 Annular Cutter Ø 45 x 75 Weldon	143,99	20	155
6 31 34 450 07 5	4014586615462	HSS-DURA 25 Annular Cutter Ø 45 x 25 Weldon TIN	96,62	20	155
6 31 34 450 07 6	4014586615509	HSS-DURA 50 Annular Cutter Ø 45 x 50 Weldon TIN	122,33	20	156
6 31 34 460 05 1	4014586615547	HSS-NOVA 25 Annular Cutter Ø 46 x 25 Weldon	79,70	20	154
6 31 34 460 05 2	4014586615608	HSS-NOVA 50 Annular Cutter Ø 46 x 50 Weldon	102,51	20	155
6 31 34 460 07 5	4014586615554	HSS-DURA 25 Annular Cutter Ø 46 x 25 Weldon TIN	107,64	20	155
6 31 34 460 07 6	4014586615615	HSS-DURA 50 Annular Cutter Ø 46 x 50 Weldon TIN	137,01	20	156
6 31 34 470 05 1	4014586615660	HSS-NOVA 25 Annular Cutter Ø 47 x 25 Weldon	79,70	20	154
6 31 34 470 05 2	4014586615707	HSS-NOVA 50 Annular Cutter Ø 47 x 50 Weldon	102,51	20	155
6 31 34 470 07 5	4014586615677	HSS-DURA 25 Annular Cutter Ø 47 x 25 Weldon TIN	107,64	20	155
6 31 34 470 07 6	4014586615714	HSS-DURA 50 Annular Cutter Ø 47 x 50 Weldon TIN	137,01	20	156
6 31 34 480 05 1	4014586615745	HSS-NOVA 25 Annular Cutter Ø 48 x 25 Weldon	83,00	20	154
6 31 34 480 05 2	4014586615783	HSS-NOVA 50 Annular Cutter Ø 48 x 50 Weldon	107,17	20	155
6 31 34 480 07 5	4014586615752	HSS-DURA 25 Annular Cutter Ø 48 x 25 Weldon TIN	117,43	20	155
6 31 34 480 07 6	4014586615790	HSS-DURA 50 Annular Cutter Ø 48 x 50 Weldon TIN	146,78	20	156
6 31 34 490 05 1	4014586615820	HSS-NOVA 25 Annular Cutter Ø 49 x 25 Weldon	83,00	20	154
6 31 34 490 05 2	4014586615868	HSS-NOVA 50 Annular Cutter Ø 49 x 50 Weldon	107,17	20	155
6 31 34 490 07 5	4014586615837	HSS-DURA 25 Annular Cutter Ø 49 x 25 Weldon TIN	117,43	20	155
6 31 34 490 07 6	4014586615875	HSS-DURA 50 Annular Cutter Ø 49 x 50 Weldon TIN	146,78	20	156
6 31 34 500 05 1	4014586615967	HSS-NOVA 25 Annular Cutter Ø 50 x 25 Weldon	83,00	20	154
6 31 34 500 05 2	4014586615998	HSS-NOVA 50 Annular Cutter Ø 50 x 50 Weldon	110,68	20	155
6 31 34 500 05 3	4014586616025	HSS-NOVA 75 Annular Cutter Ø 50 x 75 Weldon	161,99	20	155
6 31 34 500 07 5	4014586615974	HSS-DURA 25 Annular Cutter Ø 50 x 25 Weldon TIN	117,43	20	155
6 31 34 500 07 6	4014586616001	HSS-DURA 50 Annular Cutter Ø 50 x 50 Weldon TIN	146,78	20	156
6 31 34 510 05 1	4014586616032	HSS-NOVA 25 Annular Cutter Ø 51 x 25 Weldon	88,54	20	154
6 31 34 510 05 2	4014586616056	HSS-NOVA 50 Annular Cutter Ø 51 x 50 Weldon	122,33	20	155
6 31 34 510 07 5	4014586616049	HSS-DURA 25 Annular Cutter Ø 51 x 25 Weldon TIN	124,76	20	155
6 31 34 510 07 6	4014586616063	HSS-DURA 50 Annular Cutter Ø 51 x 50 Weldon TIN	156,57	20	156
6 31 34 520 05 1	4014586616070	HSS-NOVA 25 Annular Cutter Ø 52 x 25 Weldon	88,54	20	154
6 31 34 520 05 2	4014586616094	HSS-NOVA 50 Annular Cutter Ø 52 x 50 Weldon	122,33	20	155
6 31 34 520 07 5	4014586616087	HSS-DURA 25 Annular Cutter Ø 52 x 25 Weldon TIN	124,76	20	155



Part number	EAN	Description	Price in €	PC	Page
6 31 34 520 07 6	4014586616100	HSS-DURA 50 Annular Cutter Ø 52 x 50 Weldon TIN	156,57	20	156
6 31 34 530 05 1	4014586616117	HSS-NOVA 25 Annular Cutter Ø 53 x 25 Weldon	94,08	20	154
6 31 34 530 05 2	4014586616131	HSS-NOVA 50 Annular Cutter Ø 53 x 50 Weldon	122,33	20	155
6 31 34 530 07 5	4014586616124	HSS-DURA 25 Annular Cutter Ø 53 x 25 Weldon TIN	130,88	20	155
6 31 34 530 07 6	4014586616148	HSS-DURA 50 Annular Cutter Ø 53 x 50 Weldon TIN	165,12	20	156
6 31 34 540 05 1	4014586616155	HSS-NOVA 25 Annular Cutter Ø 54 x 25 Weldon	94,08	20	154
6 31 34 540 05 2	4014586616179	HSS-NOVA 50 Annular Cutter Ø 54 x 50 Weldon	128,15	20	155
6 31 34 540 07 5	4014586616162	HSS-DURA 25 Annular Cutter Ø 54 x 25 Weldon TIN	130,88	20	155
6 31 34 540 07 6	4014586616186	HSS-DURA 50 Annular Cutter Ø 54 x 50 Weldon TIN	165,12	20	156
6 31 34 550 05 1	4014586616193	HSS-NOVA 25 Annular Cutter Ø 55 x 25 Weldon	102,92	20	154
6 31 34 550 05 2	4014586616216	HSS-NOVA 50 Annular Cutter Ø 55 x 50 Weldon	128,15	20	155
6 31 34 550 05 3	4014586616230	HSS-NOVA 75 Annular Cutter Ø 55 x 75 Weldon	174,00	20	-
6 31 34 550 07 5	4014586616209	HSS-DURA 25 Annular Cutter Ø 55 x 25 Weldon TIN	134,56	20	155
6 31 34 550 07 6	4014586616223	HSS-DURA 50 Annular Cutter Ø 55 x 50 Weldon TIN	168,80	20	156
6 31 34 555 05 1	4014586613284	HSS-NOVA 1" Annular Cutter Ø 2-3/16" x 1" Weldon	108,48	20	-
6 31 34 555 05 2	4014586613307	HSS-NOVA 2" Annular Cutter Ø 2-3/16" x 2" Weldon	139,80	20	-
6 31 34 555 05 3	4014586613321	HSS-NOVA 3" Annular Cutter Ø 2-3/16" x 3" Weldon	192,00	20	-
6 31 34 560 05 1	4014586616247	HSS-NOVA 25 Annular Cutter Ø 56 x 25 Weldon	117,32	20	154
6 31 34 560 05 2	4014586616261	HSS-NOVA 50 Annular Cutter Ø 56 x 50 Weldon	133,96	20	155
6 31 34 560 07 5	4014586616254	HSS-DURA 25 Annular Cutter Ø 56 x 25 Weldon TIN	140,67	20	155
6 31 34 560 07 6	4014586616278	HSS-DURA 50 Annular Cutter Ø 56 x 50 Weldon TIN	176,14	20	156
6 31 34 570 05 1	4014586616285	HSS-NOVA 25 Annular Cutter Ø 57 x 25 Weldon	117,32	20	154
6 31 34 570 05 2	4014586616308	HSS-NOVA 50 Annular Cutter Ø 57 x 50 Weldon	133,96	20	155
6 31 34 570 07 5	4014586616292	HSS-DURA 25 Annular Cutter Ø 57 x 25 Weldon TIN	140,67	20	155
6 31 34 570 07 6	4014586616315	HSS-DURA 50 Annular Cutter Ø 57 x 50 Weldon TIN	176,14	20	156
6 31 34 580 05 1	4014586616322	HSS-NOVA 25 Annular Cutter Ø 58 x 25 Weldon	126,17	20	154
6 31 34 580 05 2	4014586616346	HSS-NOVA 50 Annular Cutter Ø 58 x 50 Weldon	143,29	20	155
6 31 34 580 07 5	4014586616339	HSS-DURA 25 Annular Cutter Ø 58 x 25 Weldon TIN	152,90	20	155
6 31 34 580 07 6	4014586616353	HSS-DURA 50 Annular Cutter Ø 58 x 50 Weldon TIN	190,83	20	156
6 31 34 590 05 1	4014586616360	HSS-NOVA 25 Annular Cutter Ø 59 x 25 Weldon	126,17	20	154
6 31 34 590 05 2	4014586616384	HSS-NOVA 50 Annular Cutter Ø 59 x 50 Weldon	143,29	20	155
6 31 34 590 07 5	4014586616377	HSS-DURA 25 Annular Cutter Ø 59 x 25 Weldon TIN	152,90	20	155
6 31 34 590 07 6	4014586616391	HSS-DURA 50 Annular Cutter Ø 59 x 50 Weldon TIN	190,83	20	156
6 31 34 600 05 1	4014586616407	HSS-NOVA 25 Annular Cutter Ø 60 x 25 Weldon	126,17	20	154
6 31 34 600 05 2	4014586616421	HSS-NOVA 50 Annular Cutter Ø 60 x 50 Weldon	143,29	20	155
6 31 34 600 05 3	4014586616445	HSS-NOVA 75 Annular Cutter Ø 60 x 75 Weldon	197,99	20	155
6 31 34 600 07 5	4014586616414	HSS-DURA 25 Annular Cutter Ø 60 x 25 Weldon TIN	152,90	20	155
6 31 34 600 07 6	4014586616438	HSS-DURA 50 Annular Cutter Ø 60 x 50 Weldon TIN	190,83	20	156
6 31 34 999 06 1	4014586375588	Best of core bits HSS NOVA 25 W 12,14,16,18,20,22 mm accessory set	132,60	20	154
6 31 34 999 06 2	4014586375595	Best of core bits HSS NOVA 25 W 2x 14 mm, 2x 18 mm accessory set	83,57	20	154
6 31 34 999 06 3	4014586375601	Best of core bits HSS NOVA 50 W 12,14,16,18,20,22 mm accessory set	166,03	20	154
6 31 34 999 06 4	4014586375618	Best of core bits HSS NOVA 50 W 2x 14 mm, 2x 18 mm accessory set	110,31	20	154
6 32 02 003 01 4	4014586176925	Key-type drill chucks	33,31	02	-
6 32 02 022 01 8	4014586176956	Key-type drill chucks	96,78	02	71
6 32 02 028 01 9	4014586176963	Key-type drill chucks	33,81	02	-
6 32 02 030 01 5	4014586176987	Key-type drill chucks	42,28	02	150
6 32 02 037 01 0	4014586177007	Key-type drill chucks	59,61	02	71
6 32 02 043 01 0	4014586177038	Key-type drill chucks	28,98	02	56
6 32 02 044 01 8	4014586223674	Key-type drill chucks	31,93	02	56
6 32 03 034 01 0	4014586177052	Key-type drill chucks	30,52	02	71
6 32 03 041 01 4	4014586177083	Key-type drill chucks	39,09	02	71
6 32 03 050 01 4	4014586204291	Key-type drill chucks	45,91	02	-
6 32 04 016 00 7	4014586177212	Quick-action chucks	62,88	02	71
6 32 04 017 00 1	4014586177229	Quick-action chucks	74,57	02	71
6 32 04 020 00 5	4014586177250	Quick-action chucks	49,93	02	-
6 32 04 021 00 4	4014586177267	Quick-action chucks	48,31	02	-
6 32 04 025 00 3	4014586177281	Quick-action chucks	87,87	02	71
6 32 04 028 00 8	4014586177311	Quick-action chucks	64,54	02	-
6 32 04 030 00 4	4014586177335	Quick-action chucks	64,62	02	-
6 32 04 032 00 6	4014586177359	Quick-action chucks	80,06	02	150
6 32 05 031 01 3	4014586256788	Quick-action chucks	26,22	02	-
6 32 05 032 01 6	4014586256795	Quick-action chucks	33,89	02	-
6 32 05 033 01 0	4014586266084	Quick-action chucks	81,19	02	71
6 32 05 035 01 0	4014586321721	Quick-action chucks	69,07	02	56
6 32 05 036 01 0	4014586321738	Quick-action chucks	66,64	02	56
6 32 05 037 02 0	4014586365091	Drill chuck	27,53	02	-
6 32 05 038 01 0	4014586368870	Quick-action chucks	101,52	02	150
6 32 06 018 00 5	4014586177410	Jaw chuck	91,69	02	-
6 32 06 018 01 0	4014586336459	Jaw chuck	102,35	02	149
6 32 06 019 00 9	4014586177427	Jaw chuck	83,40	02	58
6 32 06 040 00 9	4014586177441	Floating jaw chuck	134,05	02	-
6 32 06 041 00 8	4014586177458	Floating jaw chuck	123,11	02	58
6 32 06 061 02 1	4014586177465	Floating jaw chuck	132,35	02	-
6 32 06 063 01 2	4014586177489	Collet chuck	81,83	02	58
6 32 06 064 00 1	4014586177496	Collets, Ø 3.5 mm	22,74	02	149
6 32 06 065 00 5	4014586177502	Collets, Ø 4.5 mm	22,74	02	149

Accessories in numerical order

Part number	EAN	Description	Price in €	PC	Page
6 32 06 066 00 8	4014586177519	Collets, Ø 6 mm	22,74	02	149
6 32 06 067 01 1	4014586177526	Collet chuck	88,40	02	-
6 32 06 067 02 0	4014586336749	Collet chuck	98,82	02	149
6 32 06 070 00 6	4014586177533	Collets	22,74	02	149
6 32 06 075 00 4	4014586177588	Collet, Ø 9 mm	22,74	02	149
6 32 06 076 02 2	4014586177595	Floating collet chuck	128,31	02	58
6 32 06 077 00 1	4014586177601	Collet, Ø 2.8 mm	22,74	02	149
6 32 06 078 00 9	4014586177618	Collet, Ø 8 mm	22,74	02	149
6 32 06 079 00 3	4014586177625	Collet, Ø 10 mm	22,09	02	149
6 32 06 095 01 1	4014586224350	Tapping insert M6	68,60	02	172
6 32 06 096 01 4	4014586224367	Tapping insert M10	68,60	02	172
6 32 06 097 01 8	4014586224374	Tapping insert M12	68,60	02	172
6 32 06 098 01 6	4014586224381	Tapping insert M14	68,60	02	172
6 32 06 099 01 0	4014586224398	Tapping insert M16	68,60	02	172
6 32 06 100 01 1	4014586224404	Tapping insert M18	68,60	02	172
6 32 06 101 01 0	4014586224411	Tapping insert M20	68,60	02	172
6 32 06 102 01 3	4014586229294	Tapping insert M8 w/clutch	213,51	02	172
6 32 06 103 01 7	4014586229300	Tapping insert M10 w/clutch	213,51	02	172
6 32 06 104 01 5	4014586229317	Tapping insert M12 w/clutch	213,51	02	172
6 32 06 105 01 9	4014586229324	Tapping insert M14 w/clutch	213,51	02	172
6 32 06 106 01 2	4014586229331	Tapping insert M16 w/clutch	213,51	02	172
6 32 06 107 01 6	4014586229348	Tapping insert M18 w/clutch	213,51	02	172
6 32 06 108 01 4	4014586229355	Tapping insert M20 w/clutch	213,51	02	172
6 32 06 117 01 5	4014586253459	Tapping insert M6	68,60	02	172
6 32 06 118 01 3	4014586253466	Tapping insert M6 w/clutch	213,51	02	172
6 32 06 119 01 0	4014586298689	Tapping insert M22/ M24	158,66	02	176
6 32 06 120 01 0	4014586298696	Tapping insert M27	158,66	02	176
6 32 06 122 01 0	4014586298719	Tapping insert M22/ M24 with coupling	330,84	02	176
6 32 06 123 01 0	4014586298726	Tapping insert M27 with coupling	330,84	02	176
6 32 06 125 01 0	4014586298740	Interchangeable reducing insert	195,55	02	176
6 32 06 138 01 0	4014586354446	Tapping insert M8	68,60	02	172
6 32 06 139 01 0	4014586354453	Tapping insert M10	68,60	02	172
6 32 06 140 01 0	4014586354460	Tapping insert M8 w/clutch	213,51	02	172
6 32 06 141 01 0	4014586354477	Tapping insert M10 w/clutch	213,51	02	172
6 32 07 059 00 6	4014586177786	Collet, Ø 6 mm	22,74	02	105
6 32 07 069 00 5	4014586177793	Collet, Ø 8 mm	22,74	02	105
6 32 07 087 00 1	4014586177809	Collet, Ø 3 mm	22,74	02	105
6 32 07 088 00 9	4014586177816	Collet, Ø 1/4" Z	22,74	02	105
6 32 07 097 00 0	4014586177861	Collets, Ø 3 mm	22,74	02	105
6 32 07 103 00 9	4014586177922	Collets, Ø 6 mm	22,74	02	105
6 32 07 128 00 0	4014586375922	Collet, Ø 6 mm	20,76	02	105
6 32 07 129 00 0	4014586375939	Collet, Ø 8 mm	20,76	02	105
6 32 07 130 00 0	4014586375946	Collet, Ø 3 mm	20,76	02	105
6 32 07 131 00 0	4014586375953	Collet, Ø 1/4"	20,76	02	105
6 32 07 132 00 0	4014586375960	Collet, Ø 3 Inox	24,03	02	105
6 32 07 133 00 0	4014586375977	Collet, Ø 6 Inox	24,03	02	105
6 32 07 134 00 0	4014586375984	Collet, Ø 8 Inox	24,03	02	105
6 32 07 135 00 0	4014586375991	Collet, Ø 1/4" Inox	24,03	02	105
6 32 08 001 02 0	4014586368153	Drill chuck	43,46	02	-
6 32 08 002 01 0	4014586392080	Drill chuck	30,93	02	14
6 32 08 005 01 0	4014586404837	Drill chuck	41,77	02	14
6 33 01 006 00 5	4014586178103	Morse taper arbors	8,10	02	-
6 33 01 008 00 7	4014586178110	Morse taper arbors	10,17	02	-
6 33 01 012 00 5	4014586178141	Morse taper arbors	12,14	02	71
6 33 01 014 00 7	4014586178165	Morse taper arbors	16,52	02	71
6 33 01 016 00 4	4014586178172	Morse taper arbors	32,19	02	71
6 33 01 021 00 1	4014586223704	Morse taper arbors	41,28	02	-
6 33 02 002 00 0	4014586178189	Reducing sleeves	10,85	02	-
6 33 02 003 00 4	4014586178196	Reducing sleeves	14,50	02	71
6 33 02 004 00 2	4014586178202	Reducing sleeves	21,33	02	71
6 33 04 003 00 2	4014586178226	Enlargement tapers	56,15	02	-
6 33 04 004 00 0	4014586178233	Enlargement tapers	95,14	02	71
6 33 04 005 00 0	4014586312996	Enlargement tapers	158,66	02	176
6 33 05 003 00 3	4014586178257	Wedge	5,81	02	71
6 33 05 004 00 1	4014586178264	Wedge	5,92	02	71
6 33 05 006 00 8	4014586178288	Wedge	9,59	02	142
6 33 05 009 01 3	4014586230627	Drift	27,66	02	58
6 33 05 010 01 5	4014586230634	Drift	27,43	02	-
6 33 05 013 00 2	4014586178318	Key	128,39	08	-
6 34 02 027 00 0	4014586199672	Ratchet w/ square head	47,00	02	-
6 35 02 022 00 6	4014586178417	Circular saw blade	230,72	08	-
6 35 02 037 00 8	4014586178448	Saw blade	332,02	08	-
6 35 02 041 00 1	4014586178455	Saw blade	464,79	08	-
6 35 02 050 00 1	4014586178462	Saw blade	387,32	08	-
6 35 02 053 00 7	4014586178479	Saw blade	374,70	08	-
6 35 02 061 00 9	4014586178493	Saw blade	519,86	08	-





Part number	EAN	Description	Price in €	PC	Page
6 35 02 080 00 8	4014586178585	Saw blade	416,70	08	–
6 35 02 084 00 2	4014586178608	Saw blade	591,77	08	–
6 35 02 097 21 0	4014586389431	HSS saw blade round SL Ø 85 (1)	19,66	04	219
6 35 02 097 22 0	4014586389448	HSS saw blade round SL Ø 85 (2)	37,35	04	219
6 35 02 097 23 0	4014586389455	HSS saw blade round SL Ø 85 (5)	88,45	04	219
6 35 02 098 00 0	4014586178745	Saw blade	587,69	08	–
6 35 02 099 00 4	4014586178752	Saw blade	604,51	08	–
6 35 02 102 01 6	4014586178783	HSS saw blade, circular, Ø 63, 2-pack	36,32	04	234
6 35 02 102 07 0	4014586291703	HSS saw blade, circular, Ø 63, 5-pack	86,05	04	234
6 35 02 103 01 0	4014586178806	HSS saw blade, circular, Ø 80, 2-pack	38,07	04	234
6 35 02 103 03 0	4014586269504	Saw blade (circular), pack of 1	20,04	04	–
6 35 02 103 05 0	4014586291710	Saw blade, circular, 5-pack	90,20	04	234
6 35 02 106 21 0	4014586389462	HSS saw blade segmented SL Ø 85 (1)	22,54	04	219
6 35 02 106 22 0	4014586389479	HSS saw blade segmented SL Ø 85 (2)	42,83	04	219
6 35 02 106 23 0	4014586389486	HSS saw blade segmented SL Ø 85 (5)	101,45	04	219
6 35 02 113 21 0	4014586390222	Saw blade segmented SL Ø 85	19,19	04	219
6 35 02 114 21 0	4014586390239	Diamond-coated saw blade segmented SL Ø 75 x 2,2 (1)	52,40	04	225
6 35 02 114 23 0	4014586390246	Diamond-coated saw blade segmented SL Ø 75 x 2,2 (5)	235,78	04	225
6 35 02 115 01 1	4014586231914	Saw blade	65,42	04	237
6 35 02 115 03 0	4014586315058	Saw blade (5 each)	294,37	04	237
6 35 02 116 01 4	4014586231921	Saw blade	93,45	04	237
6 35 02 116 02 0	4014586315065	Saw blade (5 each)	420,53	04	237
6 35 02 118 21 0	4014586389493	Carbide saw blade segmented SL Ø 75 x 2,2 (1)	24,75	04	225
6 35 02 118 23 0	4014586389509	Carbide saw blade segmented SL Ø 75 x 2,2 (5)	111,37	04	225
6 35 02 119 01 0	4014586232348	Precision E-Cut saw blade, 1-pack	16,26	04	235
6 35 02 119 03 2	4014586258829	Precision E-Cut saw blade, 25-pack	325,37	04	235
6 35 02 119 04 8	4014586264561	Precision E-Cut saw blade, 5-pack	73,22	04	235
6 35 02 120 01 2	4014586232355	Precision E-Cut saw blade, 1-pack	16,71	04	235
6 35 02 120 03 4	4014586258836	Precision E-Cut saw blade, 25-pack	334,15	04	235
6 35 02 120 04 0	4014586264578	Precision E-Cut saw blade, 5-pack	75,18	04	235
6 35 02 121 01 1	4014586232362	Precision E-Cut saw blade, 1-pack	17,15	04	235
6 35 02 121 03 3	4014586258843	Precision E-Cut saw blade, 25-pack	342,93	04	235
6 35 02 121 04 9	4014586264585	Precision E-Cut saw blade, 5-pack	77,16	04	235
6 35 02 122 01 4	4014586232379	Precision E-Cut saw blade, 1-pack	17,59	04	235
6 35 02 122 03 6	4014586258850	Precision E-Cut saw blade, 25-pack	351,72	04	235
6 35 02 122 04 2	4014586264592	Precision E-Cut saw blade, 5-pack	79,14	04	235
6 35 02 123 01 8	4014586232386	Standard E-Cut saw blade, 1-pack	11,61	04	234
6 35 02 123 03 0	4014586250793	Standard E-Cut saw blade, 25-pack	232,22	04	234
6 35 02 123 04 6	4014586264608	Standard E-Cut saw blade, 5-pack	52,25	04	234
6 35 02 124 01 6	4014586232393	Standard E-Cut saw blade, 1-pack	12,06	04	235
6 35 02 124 03 8	4014586250809	Standard E-Cut saw blade, 25-pack	241,19	04	235
6 35 02 124 04 4	4014586264615	Standard E-Cut saw blade, 5-pack	54,26	04	235
6 35 02 125 21 0	4014586389516	Carbide saw blade segmented SL Ø 75 x 1,2 (1)	24,75	04	225
6 35 02 125 23 0	4014586389523	Carbide saw blade segmented SL Ø 75 x 1,2 (5)	111,37	04	225
6 35 02 126 21 0	4014586386157	E-Cut precision saw blade SL 50 x 35 (1)	14,35	04	221
6 35 02 126 22 0	4014586386164	E-Cut precision saw blade SL 50 x 35 (3)	40,91	04	221
6 35 02 126 23 0	4014586386171	E-Cut precision saw blade SL 50 x 35 (5)	64,60	04	221
6 35 02 126 24 0	4014586386188	E-Cut precision saw blade SL 50 x 35 (10)	122,01	04	221
6 35 02 126 25 0	4014586390260	E-Cut precision saw blade SL 50 x 35 (50)	538,26	04	221
6 35 02 127 21 0	4014586386232	E-Cut precision saw blade SLP 50 x 65 (1)	15,83	04	221
6 35 02 127 22 0	4014586386249	E-Cut precision saw blade SLP 50 x 65 (3)	45,11	04	221
6 35 02 127 23 0	4014586386256	E-Cut precision saw blade SLP 50 x 65 (5)	71,23	04	221
6 35 02 127 24 0	4014586386263	E-Cut precision saw blade SLP 50 x 65 (10)	134,55	04	221
6 35 02 127 25 0	4014586390291	E-Cut precision saw blade SLP 50 x 65 (50)	593,61	04	221
6 35 02 129 01 9	4014586248400	MINICUT HSS saw blade (20 mm), 2-pack	13,17	04	–
6 35 02 130 01 1	4014586248417	MINICUT HSS saw blade (10 mm), 2-pack	13,17	04	–
6 35 02 133 21 0	4014586386317	E-Cut standard saw blade SL 50 x 35 (1)	11,94	04	220
6 35 02 133 22 0	4014586386324	E-Cut standard saw blade SL 50 x 35 (3)	34,02	04	220
6 35 02 133 23 0	4014586386331	E-Cut standard saw blade SL 50 x 35 (5)	53,73	04	220
6 35 02 133 24 0	4014586386348	E-Cut standard saw blade SL 50 x 35 (10)	101,48	04	220
6 35 02 133 25 0	4014586390321	E-Cut standard saw blade SL 50 x 35 (50)	447,70	04	220
6 35 02 134 21 0	4014586386393	E-Cut standard saw blade SLP 50 x 65 (1)	13,16	04	220
6 35 02 134 22 0	4014586386409	E-Cut standard saw blade SLP 50 x 65 (3)	37,49	04	220
6 35 02 134 23 0	4014586386416	E-Cut standard saw blade SLP 50 x 65 (5)	59,19	04	220
6 35 02 134 24 0	4014586386423	E-Cut standard saw blade SLP 50 x 65 (10)	111,79	04	220
6 35 02 134 25 0	4014586390352	E-Cut standard saw blade SLP 50 x 65 (50)	493,20	04	220
6 35 02 135 01 9	4014586248486	Standard E-Cut saw blade, 1-pack	12,18	04	235
6 35 02 135 02 5	4014586258867	Standard E-Cut saw blade, 25-pack	243,55	04	235
6 35 02 135 03 1	4014586264622	Standard E-Cut saw blade, 5-pack	54,80	04	235
6 35 02 136 01 2	4014586248493	Standard E-Cut saw blade, 1-pack	13,16	04	235
6 35 02 136 02 8	4014586258874	Standard E-Cut saw blade, 25-pack	263,04	04	235
6 35 02 136 03 4	4014586264639	Standard E-Cut saw blade, 5-pack	59,19	04	235
6 35 02 138 01 4	4014586252247	M-Cut saw blade 2 pcs.	15,62	04	236
6 35 02 146 01 1	4014586259437	Diamond wheel, Ø 180 mm	104,34	02	143
6 35 02 147 01 5	4014586262321	Universal E-Cut saw blades	15,78	04	235
6 35 02 147 02 1	4014586264646	Universal E-Cut saw blades, 5-pack	71,04	04	235

**Accessories in numerical order**

Part number	EAN	Description	Price in €	PC	Page
6 35 02 147 03 7	4014586264721	Universal E-Cut saw blades, 25-pack	315,74	04	235
6 35 02 147 12 0	4014586369655	Best of E-Cut accessory set	68,43	04	234
6 35 02 148 01 3	4014586262338	Universal E-Cut saw blades	16,58	04	235
6 35 02 148 02 9	4014586264653	Universal E-Cut saw blades, 5-pack	74,60	04	235
6 35 02 148 03 5	4014586264738	Universal E-Cut saw blades, 25-pack	331,58	04	235
6 35 02 151 21 0	4014586386461	E-Cut universal saw blade SLP 60 x 28 (1)	15,70	04	221
6 35 02 151 22 0	4014586386478	E-Cut universal saw blade SLP 60 x 28 (3)	44,71	04	221
6 35 02 151 23 0	4014586386485	E-Cut universal saw blade SLP 60 x 28 (5)	70,56	04	221
6 35 02 151 24 0	4014586386492	E-Cut universal saw blade SLP 60 x 28 (10)	133,14	04	221
6 35 02 151 25 0	4014586390390	E-Cut universal saw blade SLP 60 x 28 (50)	587,72	04	221
6 35 02 152 21 0	4014586386539	E-Cut universal saw blade SLP 60 x 44 (1)	16,58	04	221
6 35 02 152 22 0	4014586386546	E-Cut universal saw blade SLP 60 x 44 (3)	47,25	04	221
6 35 02 152 23 0	4014586386553	E-Cut universal saw blade SLP 60 x 44 (5)	74,60	04	221
6 35 02 152 24 0	4014586386560	E-Cut universal saw blade SLP 60 x 44 (10)	140,92	04	221
6 35 02 152 25 0	4014586390437	E-Cut universal saw blade SLP 60 x 44 (50)	621,72	04	221
6 35 02 155 01 0	4014586291956	HM saw blade 1-pack	36,75	04	-
6 35 02 155 02 0	4014586294186	HM saw blade 5-pack	165,38	04	-
6 35 02 156 01 0	4014586291963	HM saw blade 1-pack	36,75	04	-
6 35 02 156 02 0	4014586294209	HM saw blade 5-pack	165,38	04	-
6 35 02 157 21 0	4014586386614	E-Cut fine saw blade SL 50 x 30 (1)	10,50	04	222
6 35 02 157 22 0	4014586386621	E-Cut fine saw blade SL 50 x 30 (3)	29,93	04	222
6 35 02 157 23 0	4014586386638	E-Cut fine saw blade SL 50 x 30 (5)	47,25	04	222
6 35 02 157 24 0	4014586386645	E-Cut fine saw blade SL 50 x 30 (10)	89,25	04	222
6 35 02 157 25 0	4014586390451	E-Cut fine saw blade SL 50 x 30 (50)	393,75	04	222
6 35 02 158 01 0	4014586304892	M-Cut saw blade 2 pcs.	18,27	04	236
6 35 02 160 21 0	4014586386690	E-Cut long-life saw blade SL 50 x 35 (1)	13,76	04	220
6 35 02 160 22 0	4014586386706	E-Cut long-life saw blade SL 50 x 35 (3)	39,21	04	220
6 35 02 160 23 0	4014586386713	E-Cut long-life saw blade SL 50 x 35 (5)	61,90	04	220
6 35 02 160 24 0	4014586386720	E-Cut long-life saw blade SL 50 x 35 (10)	116,92	04	220
6 35 02 160 25 0	4014586390482	E-Cut long-life saw blade SL 50 x 35 (50)	515,81	04	220
6 35 02 161 21 0	4014586386775	E-Cut long-life saw blade SLP 50 x 65 (1)	15,21	04	220
6 35 02 161 22 0	4014586386782	E-Cut long-life saw blade SLP 50 x 65 (3)	43,38	04	220
6 35 02 161 23 0	4014586386799	E-Cut long-life saw blade SLP 50 x 65 (5)	68,49	04	220
6 35 02 161 24 0	4014586386805	E-Cut long-life saw blade SLP 50 x 65 (10)	129,37	04	220
6 35 02 161 25 0	4014586390512	E-Cut long-life saw blade SLP 50 x 65 (50)	570,72	04	220
6 35 02 162 01 0	4014586336008	E-Cut long-life saw blade pack of 1	13,19	04	234
6 35 02 162 02 0	4014586336015	E-Cut long-life saw blade pack of 5	59,34	04	234
6 35 02 162 03 0	4014586336022	E-Cut long-life saw blade pack of 25	263,68	04	234
6 35 02 162 15 0	4014586376295	Best of E-Cut accessory set XXL	96,99	04	234
6 35 02 163 01 0	4014586336039	E-Cut long-life saw blade pack of 1	13,69	04	234
6 35 02 163 02 0	4014586336046	E-Cut long-life saw blade pack of 5	61,59	04	234
6 35 02 163 03 0	4014586336053	E-Cut long-life saw blade pack of 25	273,75	04	234
6 35 02 164 01 0	4014586336060	E-Cut long-life saw blade pack of 1	14,03	04	234
6 35 02 164 02 0	4014586336077	E-Cut long-life saw blade pack of 5	63,14	04	234
6 35 02 164 03 0	4014586336084	E-Cut long-life saw blade pack of 25	280,60	04	234
6 35 02 165 01 0	4014586336091	E-Cut long-life saw blade pack of 1	15,21	04	234
6 35 02 165 02 0	4014586336107	E-Cut long-life saw blade pack of 5	68,49	04	234
6 35 02 165 03 0	4014586336114	E-Cut long-life saw blade pack of 25	304,37	04	234
6 35 02 166 21 0	4014586390536	Diamond-coated saw blade segmented SLP Ø 90 x 2,2 (1)	61,95	04	225
6 35 02 166 23 0	4014586390543	Diamond-coated saw blade segmented SLP Ø 90 x 2,2 (5)	278,78	04	225
6 35 02 167 01 0	4014586342023	Diamond-coated saw blade	94,40	04	237
6 35 02 167 02 0	4014586342030	Diamond-coated saw blade, 5-pack	424,78	04	237
6 35 02 168 01 0	4014586342047	Diamond-coated saw blade	94,40	04	237
6 35 02 168 02 0	4014586342054	Diamond-coated saw blade, 5-pack	424,78	04	237
6 35 02 169 21 0	4014586390550	Carbide saw blade segmented SLP Ø 90 x 2,2 (1)	29,39	04	225
6 35 02 169 23 0	4014586390567	Carbide saw blade segmented SLP Ø 90 x 2,2 (5)	132,26	04	225
6 35 02 170 21 0	4014586390574	Carbide saw blade segmented SLP Ø 90 x 1,2 (1)	30,26	04	225
6 35 02 170 23 0	4014586390581	Carbide saw blade segmented SLP Ø 90 x 1,2 (5)	136,17	04	225
6 35 02 172 01 0	4014586347691	HM saw blade 1-pack	36,75	04	236
6 35 02 172 02 0	4014586347707	HM saw blade 5-pack	165,38	04	236
6 35 02 173 01 0	4014586347714	HM saw blade 1-pack	36,75	04	236
6 35 02 173 02 0	4014586347721	HM saw blade 5-pack	165,38	04	236
6 35 02 174 21 0	4014586389530	HSS saw blade round SL Ø 85 x 0,7 (1)	40,17	04	219
6 35 02 174 23 0	4014586389547	HSS saw blade round SL Ø 85 x 0,7 (5)	180,78	04	219
6 35 02 175 21 0	4014586389554	HSS saw blade round SLP Ø 100 x 0,7 (1)	41,82	04	219
6 35 02 175 23 0	4014586389561	HSS saw blade round SLP Ø 100 x 0,7 (5)	188,20	04	219
6 35 02 176 21 0	4014586389578	HSS saw blade round SLP Ø 100 x 0,8 (1)	49,82	04	219
6 35 02 177 01 0	4014586379494	Saw blade	40,98	04	234
6 35 02 177 05 0	4014586379500	HSS saw blade pack of 5	184,39	04	234
6 35 02 178 01 0	4014586379517	Saw blade	42,66	04	234
6 35 02 178 05 0	4014586379524	HSS saw blade pack of 5	191,96	04	234
6 35 02 179 01 0	4014586379272	HSS single saw blade, wood	50,82	04	235
6 35 02 179 02 0	4014586379289	Set with depth stop	66,76	04	236
6 35 02 181 00 0	4014586354606	Circular saw blade	289,22	08	-
6 35 02 183 21 0	4014586386850	E-Cut long-life saw blade SL 34 x 20 (1)	10,50	04	219
6 35 02 183 22 0	4014586386867	E-Cut long-life saw blade SL 34 x 20 (3)	29,93	04	219



Part number	EAN	Description	Price in €	PC	Page
6 35 02 183 23 0	4014586386874	E-Cut long-life saw blade SL 34 x 20 (5)	47,25	04	219
6 35 02 183 24 0	4014586386881	E-Cut long-life saw blade SL 34 x 20 (10)	89,25	04	219
6 35 02 183 25 0	4014586390604	E-Cut long-life saw blade SL 34 x 20 (50)	393,75	04	219
6 35 02 184 21 0	4014586386935	E-Cut long-life saw blade SL 30 x 10 (1)	8,11	04	219
6 35 02 184 22 0	4014586386942	E-Cut long-life saw blade SL 30 x 10 (3)	23,10	04	219
6 35 02 184 23 0	4014586386959	E-Cut long-life saw blade SL 30 x 10 (5)	36,48	04	219
6 35 02 184 24 0	4014586386966	E-Cut long-life saw blade SL 30 x 10 (10)	68,90	04	219
6 35 02 184 25 0	4014586390635	E-Cut long-life saw blade SL 30 x 10 (50)	303,98	04	219
6 35 02 185 01 0	4014586369723	E-Cut long-life saw blade pack of 1	10,71	04	234
6 35 02 185 02 0	4014586369730	E-Cut long-life saw blade pack of 5	48,20	04	234
6 35 02 185 03 0	4014586369747	E-Cut long-life saw blade pack of 25	214,20	04	234
6 35 02 186 01 0	4014586369754	E-Cut long-life saw blade pack of 1	8,26	04	234
6 35 02 186 02 0	4014586369761	E-Cut long-life saw blade pack of 5	37,20	04	234
6 35 02 186 03 0	4014586369778	E-Cut long-life saw blade pack of 25	165,36	04	234
6 35 02 187 21 0	4014586390659	Carbide saw blade segmented SLP Ø 90	38,85	04	222
6 35 02 188 21 0	4014586390666	Diamond-coated saw blade segmented SLP Ø 90	78,82	04	222
6 35 02 189 01 0	4014586377537	Carbide saw blade with open teeth	43,68	04	236
6 35 02 190 01 0	4014586377544	Diamond segment saw blade with open teeth	105,28	04	236
6 35 02 191 21 0	4014586389585	E-Cut carbide saw blade SLP 50 x 35	27,42	04	222
6 35 02 192 01 0	4014586378152	E-Cut carbide saw blade	26,88	04	236
6 35 02 193 21 0	4014586389592	E-Cut diamond saw blade SLP 50 x 35	44,55	04	222
6 35 02 194 01 0	4014586378176	E-Cut diamond saw blade	43,68	04	236
6 35 02 195 01 0	4014586378183	E-Cut diamond saw blade	48,16	04	236
6 35 02 196 01 0	4014586379531	Saw blade	42,66	04	234
6 35 02 196 05 0	4014586379548	Saw blade (5 each)	191,96	04	234
6 35 02 196 21 0	4014586389608	HSS saw blade segmented SLP Ø 100 x 0,7 (1)	41,82	04	219
6 35 02 196 23 0	4014586389615	HSS saw blade segmented SLP Ø 100 x 0,7 (5)	188,20	04	219
6 35 02 198 21 0	4014586387017	E-Cut precision saw blade SLP 50 x 45 (1)	15,04	04	221
6 35 02 198 22 0	4014586387024	E-Cut precision saw blade SLP 50 x 45 (3)	42,85	04	221
6 35 02 198 23 0	4014586387031	E-Cut precision saw blade SLP 50 x 45 (5)	67,66	04	221
6 35 02 198 24 0	4014586387048	E-Cut precision saw blade SLP 50 x 45 (10)	127,82	04	221
6 35 02 198 25 0	4014586390673	E-Cut precision saw blade SLP 50 x 45 (50)	563,88	04	221
6 35 02 199 21 0	4014586387093	E-Cut precision saw blade SLP 50 x 55 (1)	15,44	04	221
6 35 02 199 22 0	4014586387109	E-Cut precision saw blade SLP 50 x 55 (3)	43,98	04	221
6 35 02 199 23 0	4014586387116	E-Cut precision saw blade SLP 50 x 55 (5)	69,46	04	221
6 35 02 199 24 0	4014586387123	E-Cut precision saw blade SLP 50 x 55 (10)	131,19	04	221
6 35 02 199 25 0	4014586390697	E-Cut precision saw blade SLP 50 x 55 (50)	578,75	04	221
6 35 02 200 21 0	4014586387178	E-Cut standard saw blade SLM 78 x 32 (1)	11,61	04	-
6 35 02 200 22 0	4014586387185	E-Cut standard saw blade SLM 78 x 32 (3)	33,09	04	-
6 35 02 200 23 0	4014586387192	E-Cut standard saw blade SLM 78 x 32 (5)	52,25	04	-
6 35 02 200 24 0	4014586387208	E-Cut standard saw blade SLM 78 x 32 (10)	98,68	04	-
6 35 02 200 25 0	4014586390710	E-Cut standard saw blade SLM 78 x 32 (50)	435,36	04	-
6 35 02 201 21 0	4014586387253	E-Cut long-life saw blade SLM 78 x 32 (1)	13,19	04	-
6 35 02 201 22 0	4014586387260	E-Cut long-life saw blade SLM 78 x 32 (3)	37,57	04	-
6 35 02 201 23 0	4014586387277	E-Cut long-life saw blade SLM 78 x 32 (5)	59,34	04	-
6 35 02 201 24 0	4014586387284	E-Cut long-life saw blade SLM 78 x 32 (10)	112,07	04	-
6 35 02 201 25 0	4014586390734	E-Cut long-life saw blade SLM 78 x 32 (50)	494,40	04	-
6 35 02 202 21 0	4014586387338	E-Cut standard saw blade SLM 78 x 42 (1)	12,06	04	228
6 35 02 202 22 0	4014586387345	E-Cut standard saw blade SLM 78 x 42 (3)	34,37	04	228
6 35 02 202 23 0	4014586387352	E-Cut standard saw blade SLM 78 x 42 (5)	54,26	04	228
6 35 02 202 24 0	4014586387369	E-Cut standard saw blade SLM 78 x 42 (10)	102,50	04	228
6 35 02 202 25 0	4014586390802	E-Cut standard saw blade SLM 78 x 42 (50)	452,24	04	228
6 35 02 203 21 0	4014586387413	E-Cut long-life saw blade SLM 78 x 42 (1)	13,69	04	228
6 35 02 203 22 0	4014586387420	E-Cut long-life saw blade SLM 78 x 42 (3)	39,01	04	228
6 35 02 203 23 0	4014586387437	E-Cut long-life saw blade SLM 78 x 42 (5)	61,59	04	228
6 35 02 203 24 0	4014586387444	E-Cut long-life saw blade SLM 78 x 42 (10)	116,34	04	228
6 35 02 203 25 0	4014586390826	E-Cut long-life saw blade SLM 78 x 42 (50)	513,28	04	228
6 35 02 204 21 0	4014586389622	E-Cut diamond saw blade SLM 60 x 44	48,16	04	228
6 35 02 205 21 0	4014586387499	E-Cut precision BIM saw blade SL 50 x 35 (1)	15,95	04	220
6 35 02 205 22 0	4014586387505	E-Cut precision BIM saw blade SL 50 x 35 (3)	45,45	04	220
6 35 02 205 23 0	4014586387512	E-Cut precision BIM saw blade SL 50 x 35 (5)	71,78	04	220
6 35 02 205 24 0	4014586387529	E-Cut precision BIM saw blade SL 50 x 35 (10)	135,58	04	220
6 35 02 205 25 0	4014586390840	E-Cut precision BIM saw blade SL 50 x 35 (50)	598,11	04	220
6 35 02 206 21 0	4014586387574	E-Cut precision BIM saw blade SLP 50 x 45 (1)	16,71	04	221
6 35 02 206 22 0	4014586387581	E-Cut precision BIM saw blade SLP 50 x 45 (3)	47,62	04	221
6 35 02 206 23 0	4014586387598	E-Cut precision BIM saw blade SLP 50 x 45 (5)	75,18	04	221
6 35 02 206 24 0	4014586387604	E-Cut precision BIM saw blade SLP 50 x 45 (10)	142,01	04	221
6 35 02 206 25 0	4014586390864	E-Cut precision BIM saw blade SLP 50 x 45 (50)	626,54	04	221
6 35 02 207 21 0	4014586387659	E-Cut precision BIM saw blade SLP 50 x 55 (1)	17,15	04	221
6 35 02 207 22 0	4014586387666	E-Cut precision BIM saw blade SLP 50 x 55 (3)	48,87	04	221
6 35 02 207 23 0	4014586387673	E-Cut precision BIM saw blade SLP 50 x 55 (5)	77,16	04	221
6 35 02 207 24 0	4014586387680	E-Cut precision BIM saw blade SLP 50 x 55 (10)	145,75	04	221
6 35 02 207 25 0	4014586390888	E-Cut precision BIM saw blade SLP 50 x 55 (50)	643,01	04	221
6 35 02 208 21 0	4014586387734	E-Cut precision BIM saw blade SLP 50 x 65 (1)	17,59	04	221
6 35 02 208 22 0	4014586387741	E-Cut precision BIM saw blade SLP 50 x 65 (3)	50,13	04	221
6 35 02 208 23 0	4014586387758	E-Cut precision BIM saw blade SLP 50 x 65 (5)	79,14	04	221



Accessories in numerical order

Part number	EAN	Description	Price in €	PC	Page
6 35 02 208 24 0	4014586387765	E-CUT precision BIM saw blade SLP 50 x 65 (10)	149,48	04	221
6 35 02 208 25 0	4014586390901	E-CUT precision BIM saw blade SLP 50 x 65 (50)	659,47	04	221
6 35 02 209 01 0	4014586381602	E-CUT precision BIM saw blade (35 mm) VE1	16,26	04	235
6 35 02 209 02 0	4014586381619	E-CUT precision BIM saw blade (35 mm) VE5	73,22	04	235
6 35 02 209 03 0	4014586381626	E-CUT Precision BIM saw blade (35 mm) VE25	325,37	04	235
6 35 02 210 01 0	4014586381633	E-CUT precision BIM saw blade (45 mm) VE1	16,71	04	235
6 35 02 210 02 0	4014586381640	E-CUT precision BIM saw blade (45 mm) VE5	75,18	04	235
6 35 02 210 03 0	4014586381657	E-CUT precision BIM saw blade (45 mm) VE25	334,15	04	235
6 35 02 211 01 0	4014586381664	E-CUT precision BIM saw blade (55 mm) VE1	17,15	04	235
6 35 02 211 02 0	4014586381671	E-CUT precision BIM saw blade (55 mm) VE5	77,16	04	235
6 35 02 211 03 0	4014586381688	E-CUT Precision BIM saw blade (55 mm) VE25	342,93	04	235
6 35 02 212 01 0	4014586381695	E-CUT precision BIM saw blade (65 mm) VE1	17,59	04	235
6 35 02 212 02 0	4014586381701	E-CUT precision BIM saw blade (65 mm) VE5	79,14	04	235
6 35 02 212 03 0	4014586381718	E-CUT Precision BIM saw blade (65 mm) VE25	351,72	04	235
6 35 02 213 21 0	4014586390925	Carbide saw blade round SLM Ø 105 x 2,2 (1)	36,75	04	228
6 35 02 213 23 0	4014586390932	Carbide saw blade round SLM Ø 105 x 2,2 (5)	164,85	04	228
6 35 02 214 21 0	4014586390949	Carbide saw blade round SLM Ø 105 x 1,2 (1)	36,75	04	228
6 35 02 214 23 0	4014586390956	Carbide saw blade round SLM Ø 105 x 1,2 (5)	165,38	04	228
6 35 02 215 21 0	4014586390963	Carbide saw blade segmented SLM Ø 105 x 1,2	44,55	04	228
6 35 02 216 21 0	4014586390970	Diamond-coated saw blade segmented SL Ø 75 x 1,2 (1)	52,40	04	225
6 35 02 216 23 0	4014586390987	Diamond-coated saw blade segmented SL Ø 75 x 1,2 (5)	235,78	04	225
6 35 02 217 21 0	4014586390994	Diamond-coated saw blade segmented SLP Ø 90 x 1,2 (1)	61,95	04	225
6 35 02 217 23 0	4014586391007	Diamond-coated saw blade segmented SLP Ø 90 x 1,2 (5)	278,78	04	225
6 35 02 218 21 0	4014586391014	Diamond-coated saw blade round SLM Ø 105 x 2,2 (1)	94,40	04	229
6 35 02 218 23 0	4014586391021	Diamond-coated saw blade round SLM Ø 105 x 2,2 (5)	424,78	04	229
6 35 02 219 21 0	4014586391038	Diamond-coated saw blade round SLM Ø 105 x 1,2 (1)	94,40	04	229
6 35 02 219 23 0	4014586391045	Diamond-coated saw blade round SLM Ø 105 x 1,2 (5)	424,78	04	229
6 35 02 220 21 0	4014586391052	Diamond-coated saw blade segmented SLM Ø 105 x 1,2	107,39	04	228
6 35 02 221 21 0	4014586400402	E-CUT long-life saw blade	14,92	04	220
6 35 02 221 22 0	4014586400419	E-CUT long-life saw blade	42,53	04	220
6 35 02 221 23 0	4014586400426	E-CUT long-life saw blade	67,15	04	220
6 35 02 221 24 0	4014586400433	E-CUT long-life saw blade	126,83	04	220
6 35 02 221 25 0	4014586400440	E-CUT long-life saw blade	559,52	04	220
6 35 02 222 21 0	4014586400457	E-CUT universal saw blade	15,48	04	221
6 35 02 222 22 0	4014586400464	E-CUT universal saw blade	44,11	04	221
6 35 02 222 23 0	4014586400471	E-CUT universal saw blade	69,65	04	221
6 35 02 222 24 0	4014586400488	E-CUT universal saw blade	131,55	04	221
6 35 02 222 25 0	4014586400495	E-CUT universal saw blade	580,39	04	221
6 35 02 223 21 0	4014586400501	E-CUT universal saw blade	16,25	04	221
6 35 02 223 22 0	4014586400518	E-CUT universal saw blade	46,33	04	221
6 35 02 223 23 0	4014586400525	E-CUT universal saw blade	73,14	04	221
6 35 02 223 24 0	4014586400532	E-CUT universal saw blade	138,16	04	221
6 35 02 223 25 0	4014586400549	E-CUT universal saw blade	609,53	04	221
6 35 02 224 21 0	4014586408170	E-CUT Long-Life saw blade SLM 90 x 32 (1)	13,19	04	228
6 35 02 224 22 0	4014586408187	E-CUT Long-Life saw blade SLM 90 x 32 (3)	37,59	04	228
6 35 02 224 23 0	4014586408194	E-CUT Long-Life saw blade SLM 90 x 32 (5)	59,35	04	228
6 35 02 224 24 0	4014586408200	E-CUT Long-Life saw blade SLM 90 x 32 (10)	112,10	04	228
6 35 02 224 25 0	4014586408217	E-CUT Long-Life saw blade SLM 90 x 32 (50)	494,55	04	228
6 35 02 225 21 0	4014586408262	E-CUT Standard saw blade curved SL 50 x 65 (1)	13,16	04	220
6 35 02 225 22 0	4014586408279	E-CUT Standard saw blade curved SL 50 x 65 (3)	37,50	04	220
6 35 02 225 23 0	4014586408286	E-CUT Standard saw blade curved SL 50 x 65 (5)	59,21	04	220
6 35 02 225 24 0	4014586408293	E-CUT Standard saw blade curved SL 50 x 65 (10)	111,84	04	220
6 35 02 225 25 0	4014586408309	E-CUT Standard saw blade curved SL 50 x 65 (50)	493,37	04	220
6 35 02 226 21 0	4014586408354	E-CUT Standard saw blade curved SL 50 x 50 (1)	12,72	04	220
6 35 02 226 22 0	4014586408361	E-CUT Standard saw blade curved SL 50 x 50 (3)	36,24	04	220
6 35 02 226 23 0	4014586408378	E-CUT Standard saw blade curved SL 50 x 50 (5)	57,23	04	220
6 35 02 226 24 0	4014586408385	E-CUT Standard saw blade curved SL 50 x 50 (10)	108,09	04	220
6 35 02 226 25 0	4014586408392	E-CUT Standard saw blade curved SL 50 x 50 (50)	476,84	04	220
6 35 02 227 21 0	4014586408446	E-CUT Standard saw blade curved SL 50 x 35 (1)	12,18	04	220
6 35 02 227 22 0	4014586408453	E-CUT Standard saw blade curved SL 50 x 35 (3)	34,71	04	220
6 35 02 227 23 0	4014586408460	E-CUT Standard saw blade curved SL 50 x 35 (5)	54,81	04	220
6 35 02 227 24 0	4014586408477	E-CUT Standard saw blade curved SL 50 x 35 (10)	103,53	04	220
6 35 02 227 25 0	4014586408484	E-CUT Standard saw blade curved SL 50 x 35 (50)	456,75	04	220
6 35 02 228 21 0	4014586408538	E-CUT Long-Life saw blade SL 50 x 65 (1)	13,97	04	220
6 35 02 228 22 0	4014586408545	E-CUT Long-Life saw blade SL 50 x 65 (3)	39,81	04	220
6 35 02 228 23 0	4014586408552	E-CUT Long-Life saw blade SL 50 x 65 (5)	62,84	04	220
6 35 02 228 24 0	4014586408569	E-CUT Long-Life saw blade SL 50 x 65 (10)	118,70	04	220
6 35 02 228 25 0	4014586408576	E-CUT Long-Life saw blade SL 50 x 65 (50)	523,69	04	220
6 35 02 229 21 0	4014586408620	E-CUT Precision BIM saw blade SL 50 x 65 (1)	14,49	04	221
6 35 02 229 22 0	4014586408637	E-CUT Precision BIM saw blade SL 50 x 65 (3)	41,30	04	221
6 35 02 229 23 0	4014586408644	E-CUT Precision BIM saw blade SL 50 x 65 (5)	65,21	04	221
6 35 02 229 24 0	4014586408651	E-CUT Precision BIM saw blade SL 50 x 65 (10)	123,17	04	221
6 35 02 229 25 0	4014586408668	E-CUT Precision BIM saw blade SL 50 x 65 (50)	543,38	04	221
6 35 02 230 21 0	4014586408712	E-CUT Precision saw blade SL 50 x 65 (1)	13,97	04	221
6 35 02 230 22 0	4014586408729	E-CUT Precision saw blade SL 50 x 65 (3)	39,81	04	221
6 35 02 230 23 0	4014586408736	E-CUT Precision saw blade SL 50 x 65 (5)	62,84	04	221



Part number	EAN	Description	Price in €	PC	Page
6 35 02 230 24 0	4014586408743	E-CUT Precision saw blade SL 50 x 65 (10)	118,70	04	221
6 35 02 230 25 0	4014586408750	E-CUT Precision saw blade SL 50 x 65 (50)	523,69	04	221
6 35 02 231 21 0	4014586408804	E-CUT Standard saw blade SLM 90 x 32 (1)	11,61	04	228
6 35 02 231 22 0	4014586408811	E-CUT Standard saw blade SLM 90 x 32 (3)	33,10	04	228
6 35 02 231 23 0	4014586408828	E-CUT Standard saw blade SLM 90 x 32 (5)	52,26	04	228
6 35 02 231 24 0	4014586408835	E-CUT Standard saw blade SLM 90 x 32 (10)	98,71	04	228
6 35 02 231 25 0	4014586408842	E-CUT Standard saw blade SLM 90 x 32 (50)	435,49	04	228
6 35 03 035 01 1	4014586178912	HSS saw blade pack of 5	10,46	02	-
6 35 03 036 01 4	4014586178929	Saw blades, 5-pack	10,46	02	-
6 35 03 037 01 8	4014586178936	Saw blades, 5-pack	10,46	02	-
6 35 03 038 01 6	4014586178943	Saw blades, 5-pack	10,46	02	-
6 35 03 039 01 0	4014586178950	Saw blades, 5-pack	12,44	02	-
6 35 03 040 00 3	4014586178967	Saw blade	13,21	02	-
6 35 03 042 01 4	4014586178998	Saw blades, 3-pack	11,95	02	-
6 35 03 043 01 8	4014586179001	Saw blades, 3-pack	11,95	02	-
6 35 03 047 01 7	4014586179049	Saw blades, 3-pack	15,10	02	-
6 35 03 048 01 5	4014586179056	Saw blades, 3-pack	15,10	02	-
6 35 03 051 01 0	4014586179087	Saw blades, 3-pack	21,86	02	-
6 35 03 058 01 4	4014586179148	Saw blades, 3-pack	21,70	02	-
6 35 03 059 01 8	4014586179155	Saw blades, 3-pack	21,86	02	-
6 35 03 060 01 0	4014586179162	Saw blades, 5-pack	11,64	02	-
6 35 03 061 01 9	4014586179186	Saw blade	41,66	02	-
6 35 03 063 00 7	4014586179209	HSS saw blade	10,56	02	-
6 35 03 064 00 5	4014586179216	HSS saw blade	14,63	02	-
6 35 03 065 00 9	4014586179223	HSS saw blade	6,87	02	-
6 35 03 066 00 2	4014586179230	HSS saw blade	8,40	02	-
6 35 03 067 00 6	4014586179247	HSS saw blade	8,73	02	-
6 35 03 068 00 4	4014586179254	HSS saw blade	14,62	02	-
6 35 03 069 00 8	4014586179261	HSS saw blade	19,03	02	-
6 35 03 070 00 0	4014586179278	HSS saw blade	10,47	02	-
6 35 03 071 00 9	4014586179285	Saw blade	7,35	02	-
6 35 03 072 00 2	4014586179292	HSS saw blade	29,84	02	-
6 35 03 073 00 6	4014586179308	HSS saw blade	36,25	02	-
6 35 03 076 01 0	4014586179339	Saw blades, 5-pack	15,94	02	-
6 35 03 077 01 4	4014586179346	Saw blades, 5-pack	18,31	02	-
6 35 03 082 01 0	4014586179360	Saw blades, 5-pack	11,66	02	-
6 35 03 087 01 3	4014586179391	Saw blades, 5-pack	10,46	02	-
6 35 03 088 01 1	4014586179407	Saw blades, 5-pack	12,89	02	-
6 35 03 089 01 5	4014586179414	Saw blades, 5-pack	30,18	02	-
6 35 03 093 00 4	4014586200774	HD saw blade	18,85	02	-
6 35 03 094 00 2	4014586200781	HD saw blade	25,18	02	-
6 35 03 095 00 6	4014586200798	HD saw blade	25,18	02	-
6 35 03 096 01 8	4014586202921	TD saw blade	178,50	02	-
6 35 03 097 01 2	4014586202938	TD saw blade	237,30	02	-
6 35 03 098 00 1	4014586212548	Saw blade	42,48	02	-
6 35 03 099 00 5	4014586212555	Saw blade	34,76	02	-
6 35 03 100 00 6	4014586212562	Saw blade	27,13	02	-
6 35 03 112 01 0	4014586305370	Saw blades, 5-pack	13,70	02	-
6 35 03 113 01 0	4014586305387	Saw blades, 5-pack	13,70	02	-
6 35 03 114 01 0	4014586305394	Saw blades, 5-pack	24,71	02	-
6 35 03 115 01 0	4014586305417	Saw blade, 3-pack	11,82	02	-
6 35 03 116 01 0	4014586305424	Saw blade, 3-pack	11,82	02	-
6 35 03 123 01 0	4014586305431	Saw blade, 3-pack	14,63	02	-
6 35 08 056 00 4	4014586179506	Form cutter	888,56	08	-
6 35 08 081 00 9	4014586179513	Form cutter	1.492,62	08	-
6 35 08 085 00 8	4014586179520	Form cutter	1.884,05	08	-
6 35 08 089 00 7	4014586179551	Form cutter	1.726,55	08	-
6 35 08 095 00 0	4014586349442	Angled milling cutter, left	777,03	08	-
6 35 08 096 00 0	4014586349459	Angled milling cutter, right	777,03	08	-
6 35 08 098 00 0	4014586354613	Angled milling cutter, right	1.032,93	08	-
6 35 08 099 00 0	4014586354620	Angled milling cutter, left	1.032,93	08	-
6 35 08 099 02 0	4014586356426	Cutter set, right/left	2.238,00	08	-
6 36 01 101 00 9	4014586179766	1 pair of blades	22,03	02	127
6 36 02 001 00 4	4014586179797	Cutter blades, up to 2.0 mm	9,78	02	-
6 36 02 046 00 2	4014586179834	Cutter blades, up to 2.0 mm	17,00	02	-
6 36 02 048 00 4	4014586224053	Punch	19,09	02	132
6 36 02 048 01 3	4014586246260	Punches and dies	59,66	02	132
6 36 02 048 04 0	4014586317984	Punch (5 ea)	76,25	02	132
6 36 02 048 05 0	4014586317991	Punch VE10	132,81	02	132
6 36 02 049 00 8	4014586246611	Punch	56,50	02	132
6 36 02 049 01 7	4014586246628	Punches and dies	131,11	02	132
6 36 02 049 04 0	4014586318004	Punch (2 ea)	102,09	02	132
6 36 02 049 05 0	4014586318011	Punch (5 ea)	226,30	02	132
6 36 02 050 00 0	4014586264370	Punch	16,83	02	133
6 36 02 050 01 0	4014586269511	Punch VE10	118,06	02	133
6 36 02 050 03 0	4014586318028	Punch (5 ea)	67,64	02	133

Part number	EAN	Description	Price in €	PC	Page
6 36 02 051 00 9	4014586262987	Punch	48,41	02	132
6 36 02 051 01 8	4014586264356	Punch set	98,70	02	132
6 37 06 012 02 4	4014586260884	Diamond file insert (20 mm), regular	10,62	04	-
6 37 06 014 02 6	4014586260907	Diamond file insert (10 mm), extra fine	10,82	04	-
6 37 06 015 01 0	4014586290423	Carbide file	5,34	04	-
6 37 06 018 01 0	4014586304922	HM file FSC 2 pcs	22,26	04	236
6 37 06 019 21 0	4014586389639	Carbide file SLP 30 x 10	19,11	04	226
6 37 07 008 00 2	4014586180373	Grinding wheel	10,91	02	-
6 37 13 007 00 9	4014586180717	Grinding wheel	94,11	02	-
6 37 13 008 00 7	4014586180724	Grinding wheel	94,11	02	-
6 37 13 009 00 1	4014586180731	Grinding wheel	94,11	02	-
6 37 13 010 00 3	4014586180748	Grinding wheel	105,59	02	-
6 37 13 011 00 2	4014586180755	Polishing wheel	110,44	02	-
6 37 13 013 01 8	4014586226811	Polishing wheel	121,12	02	200
6 37 13 015 01 0	4014586226835	Polishing wheel	121,12	02	200
6 37 13 016 01 3	4014586226842	Polishing wheel	121,12	02	200
6 37 14 004 00 5	4014586180779	Linen sanding belt	2,87	02	-
6 37 14 005 00 9	4014586180786	Linen sanding belt	2,87	02	-
6 37 14 006 00 2	4014586180793	Linen sanding belt	2,87	02	-
6 37 14 007 00 6	4014586180809	Linen sanding belt	2,54	02	-
6 37 14 008 00 4	4014586180816	Linen sanding belt	2,54	02	-
6 37 14 009 00 8	4014586180823	Linen sanding belt	2,54	02	-
6 37 14 010 00 0	4014586180830	Linen sanding belt	2,54	02	-
6 37 14 011 00 9	4014586180847	Linen sanding belt	3,79	02	-
6 37 14 012 00 2	4014586180854	Linen sanding belt	3,43	02	-
6 37 14 013 00 6	4014586180861	Linen sanding belt	3,43	02	-
6 37 14 014 00 4	4014586180878	Linen sanding belt	3,21	02	-
6 37 14 015 00 8	4014586180885	Linen sanding belt	3,21	02	-
6 37 14 026 00 0	4014586180960	Linen sanding belt	3,21	02	-
6 37 14 027 00 4	4014586180977	Linen sanding belt	3,21	02	-
6 37 14 044 01 0	4014586246406	Grinding belt K60 VE10	20,95	02	199
6 37 14 045 01 4	4014586246413	Grinding belt K120 VE10	20,95	02	199
6 37 14 046 01 7	4014586246420	Grinding belt K240 10/pack	20,95	02	199
6 37 14 047 01 1	4014586246437	Fleece belt, coarse	11,16	02	199
6 37 14 048 01 9	4014586246444	Fleece belt, medium	11,16	02	199
6 37 14 049 01 3	4014586246451	Fleece belt, fine	11,16	02	199
6 37 14 050 01 5	4014586259444	Grinding belt K120 VE10	29,63	02	194
6 37 14 050 02 1	4014586259451	Basic set	196,74	02	194
6 37 14 051 01 4	4014586259468	Grinding belt K180 VE10	29,63	02	194
6 37 14 052 01 7	4014586259475	Grinding belt K320 VE10	29,63	02	194
6 37 14 052 02 3	4014586259482	Polishing-set	161,61	02	194
6 37 14 053 01 1	4014586259499	Grinding belt K400 VE10	29,63	02	194
6 37 14 054 01 9	4014586259505	Grinding belt K120 VE10	48,65	02	194
6 37 14 055 01 3	4014586259512	Grinding belt K180 VE10	48,65	02	194
6 37 14 056 01 6	4014586259529	Fleece belt, K80, 5-pack	34,22	02	194
6 37 14 057 01 0	4014586259536	Fleece belt K120, 5-pack	34,22	02	194
6 37 14 058 01 8	4014586259543	Fleece belt K280, 5-pack	40,11	02	194
6 37 14 061 01 0	4014586313160	Grinding belt K80 VE10	13,23	02	194
6 37 14 062 01 0	4014586313177	Grinding belt K120 VE10	13,23	02	194
6 37 14 063 01 0	4014586313184	Grinding belt K180 VE10	13,23	02	194
6 37 14 068 01 0	4014586313191	Grinding belt K80 VE10	14,67	02	194
6 37 14 069 01 0	4014586313207	Grinding belt K120 VE10	14,67	02	194
6 37 14 070 01 0	4014586313214	Grinding belt K180 VE10	14,67	02	194
6 37 14 089 01 0	4014586313221	Grinding belt K80 VE10	20,20	02	194
6 37 14 090 01 0	4014586313238	Grinding belt K120 VE10	20,20	02	194
6 37 14 091 01 0	4014586313245	Grinding belt K180 VE10	20,20	02	194
6 37 14 114 01 0	4014586313252	Fleece belt, coarse VE5	18,72	02	194
6 37 14 115 01 0	4014586313269	Fleece belt, medium V5	18,72	02	194
6 37 14 116 01 0	4014586313276	Fleece belt, fine VE5	18,72	02	194
6 37 14 123 01 0	4014586313283	Fleece belt, coarse VE5	26,31	02	194
6 37 14 124 01 0	4014586313290	Fleece belt, medium V5	26,31	02	194
6 37 14 125 01 0	4014586313306	Fleece belt, fine VE5	26,31	02	194
6 37 14 130 01 0	4014586300849	Ceramic grinding belt	42,70	02	194
6 37 14 131 01 0	4014586300856	Ceramic grinding belt	67,08	02	194
6 37 14 132 01 0	4014586305264	Grinding sleeve K60 VE5	10,92	02	201
6 37 14 133 01 0	4014586305271	Grinding sleeve K80 VE5	10,63	02	201
6 37 14 134 01 0	4014586306674	Grinding sleeve K120 VE5	10,21	02	201
6 37 14 136 01 0	4014586329512	Grinding belt K80 VE10	23,63	02	196
6 37 14 137 01 0	4014586329529	Grinding belt K120 VE10	23,63	02	196
6 37 14 138 01 0	4014586329536	Grinding belt K180 VE10	23,63	02	196
6 37 14 139 01 0	4014586329543	Grinding belt K320 VE10	23,63	02	196
6 37 14 140 01 0	4014586329741	Grinding belt K400 VE10	23,63	02	196
6 37 14 141 01 0	4014586329550	Fleece belt, coarse VE5	32,35	02	196
6 37 14 142 01 0	4014586329567	Fleece belt, medium V5	32,35	02	196
6 37 14 143 01 0	4014586329574	Fleece belt, fine VE5	32,35	02	196
6 37 14 144 01 0	4014586330013	Polishing belt, 3-pack	18,78	02	197



Part number	EAN	Description	Price in €	PC	Page
6 37 16 066 01 1	4014586181905	Sanding sheet K60 VE50	48,56	02	–
6 37 17 081 01 8	4014586182575	Sanding sheets K40, 50/pack	16,07	04	223
6 37 17 081 04 6	4014586211114	Sanding sheets K40, 5/pack	3,86	04	223
6 37 17 082 01 1	4014586182612	Sanding sheets K60, 50/pack	16,07	04	223
6 37 17 082 03 3	4014586207667	Set of sanding sheets	16,07	04	222
6 37 17 082 04 9	4014586211121	Sanding sheets K60, 5/pack	3,86	04	223
6 37 17 083 01 5	4014586182643	Sanding sheets K80, 50/pack	16,07	04	223
6 37 17 083 04 3	4014586211138	Sanding sheets K80, 5/pack	3,86	04	223
6 37 17 084 01 3	4014586182674	Sanding sheets K100, 50/pack	16,07	04	223
6 37 17 084 04 1	4014586211145	Sanding sheets K100, 5/pack	3,86	04	223
6 37 17 085 01 7	4014586182704	Sanding sheets K120, 50/pack	16,07	04	223
6 37 17 085 04 5	4014586211152	Sanding sheets K120, 5/pack	3,86	04	223
6 37 17 086 01 0	4014586182728	Sanding sheets K36, 50/pack	23,31	04	223
6 37 17 086 04 8	4014586211107	Sanding sheets K36, 5/pack	4,17	04	223
6 37 17 087 01 4	4014586182742	Sanding sheets K150, 50/pack	16,07	04	223
6 37 17 087 04 2	4014586211169	Sanding sheets K150, 5/pack	3,86	04	223
6 37 17 088 01 2	4014586182773	Sanding sheets K180, 50/pack	16,07	04	223
6 37 17 088 04 0	4014586211176	Sanding sheets K180, 5/pack	3,86	04	223
6 37 17 089 01 6	4014586182797	Sanding sheets K220, 50/pack	16,07	04	223
6 37 17 089 04 4	4014586211183	Sanding sheets K220, 5/pack	3,86	04	223
6 37 17 090 01 8	4014586182810	Sanding sheets K240, 50/pack	16,07	04	223
6 37 17 090 04 6	4014586211190	Sanding sheets K240, 5/pack	3,86	04	223
6 37 17 107 01 1	4014586182896	Sanding sheets, perforated, K36, 50/pack	26,78	04	224
6 37 17 107 04 9	4014586211237	Sanding sheets, perforated, K36, 5/pack	4,96	04	224
6 37 17 108 01 9	4014586182919	Sanding sheets, perforated, K40, 50/pack	17,20	04	224
6 37 17 108 04 7	4014586211244	Sanding sheets, perforated, K40, 5/pack	4,17	04	224
6 37 17 109 01 3	4014586182933	Sanding sheets, perforated, K60, 50/pack	17,20	04	224
6 37 17 109 03 5	4014586213002	Set of sanding sheets	17,20	04	223
6 37 17 109 04 1	4014586211251	Sanding sheets, perforated, K60, 5/pack	4,17	04	224
6 37 17 110 01 5	4014586182957	Sanding sheets, perforated, K80, 50/pack	17,20	04	224
6 37 17 110 04 3	4014586211268	Sanding sheets, perforated, K80, 5/pack	4,17	04	224
6 37 17 111 01 4	4014586182971	Sanding sheets, perforated, K100, 50/pack	17,20	04	224
6 37 17 111 04 2	4014586211275	Sanding sheets, perforated, K100, 5/pack	4,17	04	224
6 37 17 112 01 7	4014586182995	Sanding sheets, perforated, K120, 50/pack	17,20	04	224
6 37 17 112 04 5	4014586211282	Sanding sheets, perforated, K120, 5/pack	4,17	04	224
6 37 17 113 01 1	4014586183015	Sanding sheets, perforated, K150, 50/pack	17,20	04	224
6 37 17 113 04 9	4014586211299	Sanding sheets, perforated, K150, 5/pack	4,17	04	224
6 37 17 114 01 9	4014586183039	Sanding sheets, perforated, K180, 50/pack	17,20	04	224
6 37 17 114 04 7	4014586211305	Sanding sheets, perforated, K180, 5/pack	4,17	04	224
6 37 17 115 01 3	4014586183053	Sanding sheets, perforated, K220, 50/pack	17,20	04	224
6 37 17 115 04 1	4014586211312	Sanding sheets, perforated, K220, 5/pack	4,17	04	224
6 37 17 116 01 6	4014586183077	Sanding sheets, perforated, K240, 50/pack	17,20	04	224
6 37 17 116 04 4	4014586211329	Sanding sheets, perforated, K240, 5/pack	4,17	04	224
6 37 17 120 01 4	4014586183152	Stone sanding sheets, K40, 50/pack	18,39	04	223
6 37 17 121 01 3	4014586183176	Stone sanding sheets, K80, 50/pack	16,89	04	223
6 37 17 122 01 6	4014586183190	Stone sanding sheets, K120, 50/pack	16,43	04	223
6 37 17 123 01 0	4014586183213	Stone sanding sheets, K220, 50/pack	16,43	04	223
6 37 17 124 01 8	4014586183237	Stone sanding sheets, K320, 50/pack	16,43	04	223
6 37 17 125 01 2	4014586183251	Stone sanding sheets, K400, 50/pack	16,43	04	223
6 37 17 126 01 5	4014586183275	Supersoft sanding sheets, K240, 50/pack	16,79	04	223
6 37 17 127 01 9	4014586183299	Supersoft sanding sheets, K320, 50/pack	16,79	04	223
6 37 17 128 01 7	4014586183312	Supersoft sanding sheets, K400, 50/pack	16,79	04	223
6 37 17 175 01 7	4014586183343	Stone sanding sheets, K600, 50/pack	16,43	04	223
6 37 17 176 01 0	4014586183350	Stone sanding sheets, K800, 50/pack	16,43	04	223
6 37 17 179 01 6	4014586201375	Supersoft sanding sheets, K500, 50/pack	16,79	04	223
6 37 17 184 01 2	4014586208473	Sheets for sanding finger K40, 20/pack	5,36	04	223
6 37 17 185 01 6	4014586208480	Sheets for sanding finger K60, 20/pack	5,36	04	223
6 37 17 186 01 9	4014586208497	Sheets for sanding finger K80, 20/pack	5,36	04	223
6 37 17 187 01 3	4014586208503	Sheets for sanding finger K100, 20/pack	5,36	04	223
6 37 17 188 01 1	4014586208510	Sheets for sanding finger K120, 20/pack	5,36	04	223
6 37 17 189 01 5	4014586208527	Sheets for sanding finger K150, 20/pack	5,36	04	223
6 37 17 190 01 7	4014586208534	Sheets for sanding finger K180, 20/pack	5,36	04	223
6 37 17 191 01 6	4014586208541	Sheets for sanding finger K220, 20/pack	5,36	04	223
6 37 17 192 01 9	4014586208558	Sheets for sanding finger K240, 20/pack	5,36	04	223
6 37 17 217 01 6	4014586260914	Sanding sheets, profile grinding kit K80, 25/pack	8,67	04	223
6 37 17 218 01 4	4014586260921	Sanding sheets, profile grinding kit K120, 25/pack	8,67	04	223
6 37 17 219 01 8	4014586260938	Sanding sheets, profile grinding kit K180, 25/pack	8,67	04	223
6 37 17 221 01 0	4014586282893	Sanding disc, K2800, 53/pack	9,53	02	205
6 37 17 227 01 0	4014586317182	Set of sanding sheets	10,61	04	224
6 37 17 227 02 0	4014586317199	Abrasive disc K60 VE16	10,61	04	225
6 37 17 228 02 0	4014586317205	Abrasive disc K80 VE16	10,61	04	225
6 37 17 229 01 0	4014586317212	Abrasive disc K120 VE16	10,61	04	225
6 37 17 230 02 0	4014586317229	Abrasive disc K40 VE16	10,61	04	225
6 37 17 231 02 0	4014586317236	Abrasive disc K180 VE16	10,61	04	225
6 37 17 232 01 0	4014586317243	Abrasive disc K240 VE16	10,61	04	225
6 37 17 233 01 0	4014586329581	Abras.disc gr.40(12ea)	18,10	04	225



Accessories in numerical order

Part number	EAN	Description	Price in €	PC	Page
6 37 17 233 02 0	4014586329598	Set of sanding sheets	18,10	04	225
6 37 17 234 01 0	4014586329604	Abras.disc gr.60(12ea)	18,10	04	225
6 37 17 235 01 0	4014586329611	Abras.disc gr.80(12ea)	18,10	04	225
6 37 17 236 01 0	4014586329628	Sanding sheet zirconium K40 VE35	16,45	04	224
6 37 17 237 01 0	4014586329635	Abras.disc gr.60(35ea)	16,45	04	224
6 37 17 238 01 0	4014586329642	Abras.disc gr.80(35ea)	16,45	04	224
6 37 17 239 01 0	4014586328768	Pyramix sanding sheet K280 VE5	23,12	02	195
6 37 17 239 02 0	4014586328775	Pyramix sanding sheet K280 VE25	101,78	02	195
6 37 17 240 01 0	4014586328782	Pyramix sanding sheet K400 VE5	23,12	02	195
6 37 17 240 02 0	4014586328799	Pyramix sanding sheet K400 VE25	101,78	02	195
6 37 17 241 01 0	4014586328805	Pyramix sanding sheet K800 VE5	23,12	02	195
6 37 17 241 02 0	4014586328812	Pyramix sanding sheet K800 VE25	101,78	02	195
6 37 17 242 01 0	4014586328829	Pyramix sanding sheet K1400 VE5	23,12	02	196
6 37 17 242 02 0	4014586328836	Pyramix sanding sheet K1400 VE25	101,78	02	196
6 37 17 243 01 0	4014586329659	Abras.disc gr.40(35ea)	15,37	04	223
6 37 17 244 01 0	4014586329666	Abras.disc gr.60(35ea)	15,37	04	223
6 37 17 245 01 0	4014586329673	Abras.disc gr.80(35ea)	15,37	04	223
6 37 17 246 01 0	4014586373867	Sanding sheets, foam backing	13,59	04	226
6 37 17 247 01 0	4014586373874	Sanding sheets, foam backing	13,59	04	226
6 37 17 292 02 0	4014586399140	Sanding sheets, perforated	10,61	04	224
6 37 17 293 02 0	4014586399157	Sanding sheets, perforated	10,61	04	224
6 37 17 294 02 0	4014586399164	Sanding sheets, perforated	10,61	04	224
6 37 17 295 02 0	4014586399171	Sanding sheets, perforated	10,61	04	224
6 37 17 296 02 0	4014586399188	Sanding sheets, perforated	10,61	04	224
6 37 17 297 02 0	4014586399195	Sanding sheets, perforated	10,61	04	224
6 37 17 298 01 0	4014586401430	Sanding sheets, zirconium	18,10	04	224
6 37 17 299 01 0	4014586401447	Sanding sheets, zirconium	18,10	04	224
6 37 17 300 01 0	4014586401454	Sanding sheets, zirconium	18,10	04	224
6 37 18 011 01 0	4014586334998	Polishing wheel 6 mm	14,48	02	196
6 37 19 007 01 0	4014586213101	Cleaning block	20,67	04	142
6 37 19 010 01 4	4014586213453	Sharpening stone	10,63	04	242
6 37 19 011 01 0	4014586336466	Profiling stone	18,24	02	196
6 37 19 011 22 0	4014586389646	1 Sanding plate with holes SLP (2)	19,41	04	225
6 37 21 001 00 1	4014586183428	Flap wheel	124,43	02	200
6 37 21 003 01 7	4014586226583	Abrasive fleece wheels	53,32	02	199
6 37 21 004 01 5	4014586226590	Abrasive fleece wheels	53,32	02	199
6 37 21 005 01 9	4014586226606	Abrasive fleece wheels	53,32	02	199
6 37 21 006 01 2	4014586246321	Elastic sanding cylinder	82,76	02	198
6 37 21 006 04 0	4014586306629	Standard stainless steel set for surfaces	191,16	02	198
6 37 21 007 01 6	4014586246338	Elastic sanding cylinder	82,76	02	198
6 37 21 008 01 4	4014586246345	Lamella fleece cylinder	36,00	02	199
6 37 21 009 01 8	4014586246352	Lamella fleece cylinder	36,00	02	199
6 37 21 010 01 0	4014586248448	Lamella fleece cylinder	36,00	02	199
6 37 21 015 01 0	4014586282329	Fleece 4" x 4"Gr.60/100	25,57	02	-
6 37 21 016 02 0	4014586288741	Rough stainl. steel kit	86,53	02	-
6 37 21 050 02 0	4014586306636	Stainless steel set for satin-finishing surfaces	204,96	02	198
6 37 21 051 01 0	4014586305288	Fleece wheel K180	47,20	02	199
6 37 21 052 01 0	4014586305189	Flap wheel K120	24,23	02	196
6 37 21 052 02 0	4014586306643	Stainless steel set for grinding pipes / profiles	216,14	02	196
6 37 21 054 01 0	4014586328843	Elastic sanding cylinder grit60	57,54	02	199
6 37 21 054 02 0	4014586328850	Stainless steel set for satin-finishing profiles	168,42	02	198
6 37 21 055 01 0	4014586328874	Elastic sanding cylinder grit180	57,54	02	199
6 37 21 056 01 0	4014586329062	Fleece wheel K180	33,33	02	199
6 37 22 048 01 4	4014586226736	Nylon barrel brush	37,15	02	207
6 37 23 003 00 3	4014586183633	Lambskin	14,52	02	207
6 37 23 007 00 2	4014586183688	Lambskin	7,94	02	206
6 37 23 008 00 0	4014586216720	Lambskin	7,53	02	198
6 37 23 009 00 4	4014586216737	Lambskin, 150 mm	9,66	02	201
6 37 23 010 00 6	4014586216744	Lambskin	16,50	02	197
6 37 23 011 01 4	4014586226637	Polishing ring, sisal	16,80	02	200
6 37 23 011 04 0	4014586306650	Stainless steel set for polishing surfaces / pipes / profiles	106,91	02	198
6 37 23 012 01 7	4014586226644	Polishing ring, sisal	23,46	02	200
6 37 23 013 01 1	4014586226651	Polishing ring, cloth	9,80	02	200
6 37 23 014 01 9	4014586226668	Polishing ring, cloth	7,63	02	200
6 37 23 015 01 3	4014586226675	Polishing ring, cloth	11,59	02	200
6 37 23 016 01 6	4014586226682	Polishing ring, cloth	11,17	02	200
6 37 23 017 01 0	4014586232829	Polishing sponge	13,07	02	206
6 37 23 018 01 8	4014586232836	Polishing sponge	14,41	02	206
6 37 23 019 01 2	4014586233710	Polishing rings, fleece, extra soft	9,36	02	200
6 37 23 020 01 4	4014586233727	Polishing rings, fleece, extra soft	14,61	02	200
6 37 23 021 01 3	4014586233734	Polishing ring, fleece	15,09	02	199
6 37 23 022 01 6	4014586233741	Polishing ring, fleece	17,88	02	199
6 37 23 023 01 0	4014586233918	Polishing sponge	18,83	02	206
6 37 23 024 01 8	4014586233925	Polishing sponge	18,83	02	206
6 37 23 025 01 2	4014586233932	Polishing sponge	23,96	02	207
6 37 23 026 01 5	4014586233949	Polishing sponge	23,96	02	207



Part number	EAN	Description	Price in €	PC	Page
6 37 23 028 01 0	4014586282909	Polishing sponge orange 150 mm	15,67	02	206
6 37 23 028 04 0	4014586327648	Paint refurbishing and finishing set	203,56	02	205
6 37 23 029 01 0	4014586282930	Waffled sponge 150 mm	15,67	02	206
6 37 23 031 01 0	4014586304939	Bristle fleece	10,19	04	226
6 37 23 032 01 0	4014586304946	Felt polishing pad	17,82	04	226
6 37 23 033 01 0	4014586304953	Bristle fleece 2ea	28,65	02	206
6 37 23 034 01 0	4014586304960	Polishing sponge 195 mm	17,38	02	206
6 37 23 035 01 0	4014586304977	Lamb's wool, dome shape	22,98	02	206
6 37 23 036 01 0	4014586335001	Felt polishing pad Ø 115 mm pack of 5	19,75	04	226
6 37 26 008 01 2	4014586259550	Pre-polishing paste	25,85	02	201
6 37 26 009 01 6	4014586259567	Colouring paste	25,85	02	201
6 37 26 010 01 8	4014586259574	Polishing belt, 3-pack	57,98	02	194
6 37 26 014 01 0	4014586282978	FEIN single-stage polish	41,76	02	205
6 37 26 015 01 0	4014586282985	FEIN top wax paint seal	36,55	02	206
6 37 26 016 01 0	4014586313313	Polishing belts VE3	12,00	02	194
6 37 26 019 01 0	4014586313320	Polishing belts VE3	16,53	02	194
6 37 26 025 01 0	4014586327655	Wax sealing	17,92	02	205
6 37 26 027 01 0	4014586329963	Brushing paste	7,35	02	200
6 37 26 028 01 0	4014586329970	Preliminary polishing paste	7,35	02	200
6 37 26 029 01 0	4014586329987	Rumbling paste	7,35	02	200
6 37 26 030 01 0	4014586335018	Polishing agent 250 ml	18,05	02	226
6 37 28 001 01 6	4014586184340	Sanding sheet K80 VE50	33,82	02	197
6 37 28 002 01 9	4014586184364	Abras.disc gr.100 (50ea)	33,82	02	197
6 37 28 009 01 4	4014586184500	Sanding sheet K40 VE50	95,30	02	198
6 37 28 010 01 6	4014586184524	Sanding sheet K60 VE50	89,09	02	198
6 37 28 011 01 5	4014586184548	Abras.disc gr.100 (50ea)	38,60	02	-
6 37 28 012 01 8	4014586184562	Sanding sheet K150 VE50	38,60	02	198
6 37 28 013 01 2	4014586184586	Sanding sheet K180 VE50	38,60	02	198
6 37 28 014 01 0	4014586184609	Sanding sheet K220 VE50	38,60	02	198
6 37 28 015 01 4	4014586184623	Abras.disc gr.240 (50ea)	38,60	02	198
6 37 28 017 01 1	4014586184661	Abras.disc gr.320 (50ea)	38,60	02	198
6 37 28 022 01 7	4014586184739	Sanding sheet K60 VE50	51,46	02	197
6 37 28 054 01 6	4014586185002	Abras.disc gr.100 (50ea)	80,97	02	198
6 37 28 056 01 3	4014586185040	Sanding sheet K80 VE50	80,97	02	198
6 37 28 061 01 0	4014586185101	Abras.disc gr.400 (50ea)	38,60	02	198
6 37 28 072 01 2	4014586185170	Sanding sheet K40 VE50	47,63	02	198
6 37 28 073 01 6	4014586185194	Sanding sheet K60 VE50	45,73	02	198
6 37 28 074 01 4	4014586185217	Sanding sheet K80 VE50	44,79	02	198
6 37 28 084 01 3	4014586185354	Sanding sheet K120 VE50	38,60	02	198
6 37 28 096 01 9	4014586215969	Sanding sheet K80 VE50	25,00	02	197
6 37 30 018 01 0	4014586305196	Abras.flap disc med.V10	171,00	02	196
6 37 31 001 21 0	4014586391069	Carbide rasp SL 80	26,48	04	225
6 37 31 002 21 0	4014586391076	Carbide rasp SLP	33,71	04	225
6 37 31 005 01 0	4014586348162	Carbide rasp, triangular	26,48	04	236
6 37 31 006 21 0	4014586391083	Carbide rasp SLM 110	26,48	04	229
6 37 32 001 01 8	4014586226781	Sanding fleece, coarse, 10/pack	34,23	02	195
6 37 32 002 01 1	4014586226798	Sanding fleece, medium, 10/pack	32,49	02	195
6 37 32 003 01 5	4014586226804	Sanding fleece, fine, 10/pack	27,85	02	195
6 37 32 004 01 0	4014586305493	Sanding fleece gr100 5e	19,87	02	207
6 37 32 005 01 0	4014586305202	Finishing disc	24,49	02	196
6 37 33 001 01 0	4014586282992	Humidification sponge	3,15	02	205
6 37 33 002 01 0	4014586283005	Sanding block	11,75	02	205
6 37 33 003 01 0	4014586283012	Microfiber chamois	7,18	02	198
6 37 33 005 01 0	4014586309569	Adapter FSC Qi	21,87	04	238
6 37 33 006 01 0	4014586307312	Holder	55,90	02	200
6 37 33 007 01 0	4014586327693	Cleaning putty	32,47	02	205
6 37 34 001 01 0	4014586334868	Fleece disc, pressed 3 mm, coarse	27,66	02	196
6 37 34 002 01 0	4014586334875	Fleece disc, pressed 6 mm, coarse	34,71	02	196
6 37 34 003 01 0	4014586334882	Fleece disc, pressed 3 mm, medium	20,59	02	196
6 37 34 004 01 0	4014586334899	Fleece disc, pressed 6 mm, medium	25,28	02	196
6 37 34 005 01 0	4014586334905	Fleece disc, pressed 3 mm, fine	20,59	02	196
6 37 34 006 01 0	4014586334912	Fleece disc, pressed 6 mm, fine	25,28	02	196
6 37 34 007 01 0	4014586334929	Fleece disc, pressed 6 mm, very fine	22,35	02	196
6 38 01 079 00 9	4014586185569	Inner flange	6,68	02	94
6 38 01 095 00 8	4014586185606	Inner flange	6,68	02	-
6 38 01 096 00 1	4014586185613	Inner flange	31,36	02	-
6 38 01 097 00 5	4014586185620	Inner flange	28,97	02	-
6 38 01 098 00 3	4014586185637	Inner flange	27,32	02	-
6 38 01 120 00 6	4014586185774	Inner flange	6,68	02	195
6 38 01 137 00 0	4014586185842	Inner flange	33,29	02	-
6 38 01 154 00 7	4014586185972	Threaded flange	6,68	02	195
6 38 01 176 01 1	4014586212517	Flange assy	6,68	02	-
6 38 01 178 00 4	4014586259857	adapter	21,81	02	-
6 38 02 052 00 0	4014586186115	Threaded flange	6,68	02	195
6 38 02 084 00 9	4014586186207	Threaded flange	6,68	02	94
6 38 02 098 00 7	4014586186238	Threaded flange	6,68	02	-



**Accessories in numerical order**

Part number	EAN	Description	Price in €	PC	Page
6 38 02 105 00 0	4014586186252	Threaded flange	20,66	02	-
6 38 02 106 00 3	4014586186269	Threaded flange	20,66	02	-
6 38 02 107 00 7	4014586186276	Threaded flange	27,53	02	-
6 38 02 178 02 3	4014586212890	Clamping unit	27,53	02	-
6 38 02 180 02 9	4014586212883	Clamping unit	33,29	02	-
6 38 02 183 02 5	4014586233314	Clamping unit	35,57	02	99
6 38 02 183 03 1	4014586233468	Clamping unit	35,57	02	-
6 38 02 185 02 7	4014586233321	Clamping unit	35,57	02	99
6 38 02 191 01 0	4014586356266	Fixtec quick-clamping nut	26,74	02	195
6 38 03 027 03 8	4014586228136	Arbor ass.	28,76	02	200
6 38 03 066 02 4	4014586226613	Arbor ass.	31,93	02	200
6 38 03 067 02 8	4014586226729	Arbor ass.	49,91	02	200
6 38 03 068 02 0	4014586282350	Arbor ass.	49,91	02	-
6 38 03 069 02 0	4014586282367	Arbor ass.	31,93	02	-
6 38 03 071 02 0	4014586328898	Arbor ass.	43,01	02	200
6 38 03 072 02 0	4014586328904	Arbor 5/8"	43,01	02	-
6 38 06 012 00 8	4014586186801	Sanding pad	15,81	02	206
6 38 06 030 00 4	4014586186832	Sanding pad	21,91	02	207
6 38 06 034 01 7	4014586186849	Elastic backing pad	11,62	02	99
6 38 06 076 00 1	4014586187006	Contact disc	113,62	02	-
6 38 06 077 00 5	4014586187013	Contact disc	125,11	02	-
6 38 06 087 01 3	4014586187112	Elastic backing pad	5,57	02	195
6 38 06 088 02 7	4014586187136	Sanding disc assy	73,41	02	197
6 38 06 090 02 3	4014586187174	Sanding disc assy	86,15	02	197
6 38 06 095 02 1	4014586187235	Sanding disc assy	107,33	02	197
6 38 06 101 02 0	4014586187358	Sanding disc assy	84,48	02	197
6 38 06 102 02 3	4014586187372	Sanding disc assy	106,63	02	197
6 38 06 103 02 7	4014586187396	Sanding disc assy	72,38	02	197
6 38 06 114 02 4	4014586187556	Sanding disc assy	80,73	02	197
6 38 06 116 02 1	4014586187594	Sanding disc assy	97,01	02	197
6 38 06 117 02 5	4014586187617	Sanding disc assy	93,65	02	197
6 38 06 118 02 3	4014586187631	Sanding disc assy	107,33	02	197
6 38 06 129 22 0	4014586391090	Sanding pad SL (2)	10,72	04	222
6 38 06 136 22 0	4014586391106	Sanding pad perforated SL (2)	16,44	04	223
6 38 06 138 01 5	4014586213798	Elastic backing pad	13,78	02	-
6 38 06 140 22 0	4014586391113	Felt polishing pad SL (2)	29,10	04	226
6 38 06 141 22 0	4014586391120	Sanding pad super-soft version SL (2)	14,52	04	222
6 38 06 142 22 0	4014586391137	Sanding pad flat version SL (2)	14,52	04	222
6 38 06 143 00 8	4014586187921	Sanding pad	10,33	02	-
6 38 06 143 01 7	4014586212906	Elastic backing pad	10,33	02	-
6 38 06 159 22 0	4014586391144	Sanding pad finger shape SL (2)	11,49	04	223
6 38 06 166 02 6	4014586215990	Sanding pad	95,55	02	197
6 38 06 167 02 0	4014586216003	Sanding disc assy	35,21	02	197
6 38 06 168 01 2	4014586226569	Backing pad	10,33	02	195
6 38 06 169 01 6	4014586226743	Backing pad	12,90	02	206
6 38 06 170 01 8	4014586226750	Support plate, 150 mm	15,61	02	206
6 38 06 171 01 7	4014586226767	Backing pad	24,61	02	207
6 38 06 172 01 0	4014586226774	Backing pad	13,98	02	195
6 38 06 174 01 2	4014586233420	Sanding disc assy	16,07	02	99
6 38 06 174 02 8	4014586233437	Sanding disc assy	45,91	02	99
6 38 06 178 01 1	4014586233994	Backing pad	28,97	02	206
6 38 06 179 01 5	4014586233956	Backing pad	20,56	02	206
6 38 06 181 01 6	4014586246383	Sanding strip roll	69,20	02	199
6 38 06 181 03 0	4014586306698	Standard stainless steel set for pipes	135,80	02	198
6 38 06 183 01 3	4014586260945	Profile sanding set	29,10	04	-
6 38 06 184 01 0	4014586282381	Support plate assy	13,98	02	-
6 38 06 186 01 0	4014586299228	Backing pad	31,31	02	-
6 38 06 187 01 0	4014586304984	elastic disc 170 mm 5/8"	37,14	02	206
6 38 06 188 01 0	4014586304991	Pad 150 mm 5/8"	61,98	02	206
6 38 06 190 01 0	4014586305004	elastic disc 170 mm 5/8"	37,89	02	-
6 38 06 191 01 0	4014586305011	Pad 150 mm 5/8"	63,22	02	-
6 38 06 192 01 0	4014586305257	Expansion roller	158,66	02	201
6 38 06 192 02 0	4014586306704	Stainless steel set for grinding surfaces	192,55	02	198
6 38 06 193 01 0	4014586305363	Cool sanding pad	11,12	02	195
6 38 06 193 04 0	4014586328911	Stainless steel set - Preparing to polish surfaces / pipes / profiles	132,08	02	196
6 38 06 195 21 0	4014586391151	Sanding set SLP Ø 115	24,85	04	224
6 38 06 196 01 0	4014586328935	Cool sanding pad	10,94	02	195
6 38 06 198 01 0	4014586392394	Sanding pad	26,15	02	-
6 38 06 202 01 0	4014586392608	Sanding pad	26,15	02	-
6 38 06 204 21 0	4014586399201	Sanding set	29,88	04	224
6 38 09 004 01 9	4014586246468	Adhesive strip	10,28	02	199
6 38 10 011 01 6	4014586188133	Grinding arm	572,70	02	-
6 38 10 026 01 0	4014586313337	Grinding arm	63,01	02	194
6 38 10 027 01 0	4014586313344	Grinding arm	63,01	02	194
6 38 10 030 01 0	4014586313351	Grinding arm	82,39	02	194
6 38 10 031 01 0	4014586392912	Profile grinding set	41,57	04	223



Part number	EAN	Description	Price in €	PC	Page
6 38 11 004 01 0	4014586324838	Wheel guard cover for cutting work	29,85	02	99
6 38 11 005 01 0	4014586324845	Wheel guard cover for cutting work	30,73	02	99
6 38 11 008 01 0	4014586324852	Cutting-off-guard	41,32	02	-
6 38 11 009 01 0	4014586324869	Cutting-off-guard	43,61	02	-
6 38 11 010 01 0	4014586324876	Cutting-off-guard	50,43	02	-
6 38 11 016 01 0	4014586392400	Cutting-off-guard	27,86	02	94
6 38 11 017 01 0	4014586392417	Cutting-off-guard	27,86	02	195
6 38 11 018 01 0	4014586392424	Cutting-off-guard	27,86	02	94
6 39 01 011 06 2	4014586266961	Hand strap	6,24	02	-
6 39 01 015 00 5	4014586237558	Standard strip	10,75	02	-
6 39 01 017 01 1	4014586241791	Retainer shank QI assy	160,02	02	-
6 39 01 018 01 9	4014586241807	Retainer shank MK2 QI assy	160,02	02	172
6 39 01 019 01 3	4014586241814	Retainer shank MK3 QI assy	168,09	02	172
6 39 01 020 00 6	4014586241821	Adapter M18 x 6 P1.5	20,20	02	171
6 39 01 021 01 4	4014586241845	Adapter Weldon QI assy	20,20	02	171
6 39 01 022 00 8	4014586241852	Adapter QI 1/2"	20,20	02	171
6 39 01 023 00 2	4014586241869	Adapter B16	20,20	02	171
6 39 01 023 01 1	4014586258621	Jaw chuck till 16 mm with B16 adapter	77,55	02	171
6 39 01 023 02 0	4014586317960	Jaw chuck	65,43	02	171
6 39 01 024 01 9	4014586244433	Adapter Weldon QI ass. spec	20,20	02	171
6 39 01 025 06 0	4014586289489	MINICUT and File set	34,44	04	-
6 39 01 027 01 0	4014586253480	Adapter Weldon/QuickIN	43,45	02	171
6 39 01 028 01 8	4014586254685	Adapter KBM 542 QuickIN	108,57	02	172
6 39 01 029 01 2	4014586258157	Hand strap assy	3,89	02	-
6 39 01 030 01 4	4014586262796	Autofeed screws 3.9 x 35 mm, metal, 1000/pack	44,94	02	19
6 39 01 030 02 0	4014586331928	Screws 3,9 x 35 (VE10 x 1000)	265,65	02	19
6 39 01 031 01 3	4014586262802	Autofeed screws 3.9 x 30 mm, wood, 1000/pack	44,94	02	19
6 39 01 031 02 0	4014586331935	Screws 3,9 x 30 (VE10 x 1000)	265,65	02	19
6 39 01 032 01 6	4014586262819	Autofeed screws 3.9 x 35 mm, wood, 1000/pack	44,94	02	19
6 39 01 032 02 0	4014586331942	Screws 3,9 x 35 (VE10 x 1000)	265,65	02	19
6 39 01 033 01 0	4014586262826	Autofeed screws 3.9 x 45 mm, wood, 1000/pack	58,49	02	19
6 39 01 033 02 0	4014586331959	Screws 3,9 x 45 (VE10 x 1000)	345,78	02	19
6 39 01 034 01 8	4014586262833	Autofeed screws 3.9 x 30 mm, wood/metal, 1000/pack	48,68	02	19
6 39 01 034 02 0	4014586331966	Screws 3,9 x 30 (VE10 x 1000)	345,78	02	19
6 39 01 035 01 2	4014586262840	Autofeed screws 4.2 x 35 mm, wood, 1000/pack	56,72	02	19
6 39 01 035 02 0	4014586331973	Screws 4,2 x 35 (VE10 x 1000)	335,30	02	19
6 39 01 036 01 0	4014586274096	Coolant tank assy	39,72	02	-
6 39 01 037 01 0	4014586274980	Contact and swarf guard assy	73,79	02	-
6 39 01 038 02 0	4014586298757	Taper shank M.T.3	232,46	02	176
6 39 01 038 03 0	4014586339054	Taper shank M.T.3	232,46	02	-
6 39 01 039 02 0	4014586310299	Taper shank M.T.3	158,66	02	176
6 39 01 040 01 0	4014586296647	Taper shank M.T.3	269,34	02	176
6 39 01 041 01 0	4014586296678	Taper shank M.T.3	269,34	02	176
6 39 01 042 01 0	4014586296685	Taper shank M.T.3	269,34	02	176
6 39 01 045 01 0	4014586317977	Adapter QIM/ QI	41,82	02	176
6 39 01 046 00 0	4014586329680	Clamping adapter for angled head	943,95	02	35
6 39 01 047 00 0	4014586336756	QuickIN PLUS adapter on B16	19,61	02	150
6 39 01 048 02 0	4014586355528	QuickIN-adaptors	160,02	02	172
6 39 01 049 02 0	4014586355535	QuickIN-adaptors	171,50	02	172
6 39 01 050 02 0	4014586355542	3/4" Weldon mounting shaft	160,02	02	172
6 39 01 051 02 0	4014586355559	3/4" Weldon mounting shaft	171,50	02	172
6 39 01 052 02 0	4014586355566	3/4" Weldon mounting shaft	168,09	02	172
6 39 01 053 02 0	4014586355573	3/4" Weldon mounting shaft	179,56	02	172
6 39 01 054 00 0	4014586365169	QuickIN Plus adapter for 1/2" UNF	19,61	02	150
6 39 01 054 01 0	4014586365176	Quick-action chucks	104,35	02	150
6 39 01 055 02 0	4014586371160	Retainer shank MK3 QI assy	179,56	02	172
6 39 01 057 02 0	4014586371122	Retainer shank MK2 QI assy	179,56	02	172
6 39 01 061 00 0	4014586369235	Adapter with 3/4" Weldon fitting	20,20	02	171
6 39 01 063 02 0	4014586403182	3/4" Weldon mounting shaft	160,02	02	172
6 39 01 064 02 0	4014586403199	3/4" Weldon mounting shaft	171,50	02	172
6 39 01 065 02 0	4014586403205	QuickIN-adaptors	160,02	02	172
6 39 01 066 02 0	4014586403212	QuickIN-adaptors	171,50	02	172
6 39 02 001 01 0	4014586188218	Paddle	129,57	02	-
6 39 02 002 01 3	4014586188232	Paddle	80,38	02	70
6 39 03 072 01 7	4014586188577	Blade, curved, 2-pack	68,67	04	244
6 39 03 073 01 1	4014586188584	Cutter blade, straight, 2-pack	48,58	04	242
6 39 03 076 01 6	4014586188621	Blade, U-shape, 2-pack	68,73	04	243
6 39 03 076 04 0	4014586268965	Reciprocating blade 1ea	34,97	04	-
6 39 03 079 01 2	4014586188645	Blade, U-shape, 2-pack	68,73	04	243
6 39 03 081 01 3	4014586188676	Cutter blade, straight, 2-pack	68,68	04	243
6 39 03 081 02 9	4014586194073	Reciprocating blades	74,25	04	-
6 39 03 082 01 6	4014586188683	Blade, curved, 2-pack	71,80	04	244
6 39 03 083 01 0	4014586188690	Blade, U-shape, 2-pack	71,80	04	243
6 39 03 087 01 9	4014586188737	Blade, U-shape, 2-pack	76,05	04	243
6 39 03 095 01 1	4014586188799	Blade, U-shape, 2-pack	76,05	04	243
6 39 03 097 01 8	4014586188829	Blade, straight, 2-pack	71,80	04	244

## Accessories in numerical order

Part number	EAN	Description	Price in €	PC	Page
6 39 03 099 01 0	4014586188850	Blade, straight, 2-pack	71,80	04	244
6 39 03 101 01 0	4014586188874	Blade, U-shape, 2-pack	71,80	04	243
6 39 03 103 01 7	4014586188898	Blade, straight, 2-pack	42,78	04	244
6 39 03 104 01 5	4014586188904	Blade, straight, 2-pack	58,11	04	244
6 39 03 105 01 9	4014586188911	Scraper blade, 2-pack	63,37	04	243
6 39 03 107 01 6	4014586188935	Blade, U-shape, 2-pack	79,73	04	243
6 39 03 108 01 4	4014586188942	Blade, U-shape, 2-pack	84,50	04	243
6 39 03 109 01 8	4014586188959	Blade, straight, 2-pack	47,53	04	244
6 39 03 110 01 0	4014586188966	Blade, U-shape, 2-pack	76,05	04	243
6 39 03 111 01 9	4014586188973	Blade, U-shape, 2-pack	79,73	04	243
6 39 03 113 01 6	4014586188997	Reciprocating blades	63,37	04	243
6 39 03 113 02 2	4014586189000	Scraper blade kit, 2-pack mix	63,37	04	243
6 39 03 114 01 4	4014586189017	Blade, U-shape, 2-pack	84,50	04	243
6 39 03 115 01 8	4014586189031	Blade, U-shape, 2-pack	84,50	04	243
6 39 03 116 01 1	4014586189048	Cutter blade, 5-pack	68,15	04	237
6 39 03 117 01 5	4014586189055	Cutter blade, 5-pack	21,24	04	237
6 39 03 118 01 3	4014586189062	Blade, U-shape, 2-pack	79,73	04	243
6 39 03 120 01 9	4014586189086	Blade, straight, 2-pack	63,37	04	244
6 39 03 121 01 8	4014586189093	Blade, straight, 2-pack	63,37	04	244
6 39 03 122 01 1	4014586189109	Blade, straight, 2-pack	63,37	04	244
6 39 03 123 01 5	4014586189116	Blade, straight, 2-pack	73,91	04	244
6 39 03 124 01 3	4014586189123	Blade, straight, 2-pack	73,91	04	244
6 39 03 125 01 7	4014586189130	Blade, straight, 2-pack	68,68	04	244
6 39 03 127 01 4	4014586189154	Blade, U-shape, 2-pack	84,50	04	243
6 39 03 128 01 2	4014586189161	Reciprocating blade	15,41	04	237
6 39 03 129 01 6	4014586189178	Scraper blade kit, 2-pack mix	63,37	04	243
6 39 03 129 05 0	4014586210636	Scraper blade, 2-pack	63,37	04	243
6 39 03 131 01 7	4014586210643	Scraper blade, 2-pack	63,37	04	243
6 39 03 132 01 0	4014586189208	Reciprocating blades	47,63	04	237
6 39 03 133 01 4	4014586189215	Blade, curved, 2-pack	71,80	04	244
6 39 03 143 01 3	4014586189314	Blade, straight, 2-pack	96,43	04	244
6 39 03 143 04 0	4014586268989	Reciprocating blade 1ea	47,93	04	-
6 39 03 144 01 1	4014586189321	Scraper blade, 2-pack	63,12	04	243
6 39 03 146 01 8	4014586189345	Scraper blade, 2-pack	63,12	04	243
6 39 03 147 01 2	4014586189352	Blade, U-shape, 2-pack	79,73	04	243
6 39 03 152 01 8	4014586189413	Blade, curved, 2-pack	71,80	04	244
6 39 03 153 01 2	4014586189420	Blade, U-shape, 2-pack	71,80	04	243
6 39 03 154 01 0	4014586189437	Blade, U-shape, 2-pack	76,05	04	243
6 39 03 154 03 0	4014586269016	Reciprocating blade 1ea	37,79	04	-
6 39 03 155 01 4	4014586189444	Blade, U-shape, 2-pack	79,73	04	243
6 39 03 156 01 7	4014586193939	Blade, U-shape, 2-pack	84,72	04	245
6 39 03 157 01 1	4014586195803	Blade, U-shape, 2-pack	71,80	04	243
6 39 03 160 01 5	4014586198781	Blade, straight, 2-pack	77,22	04	244
6 39 03 160 03 0	4014586269023	Reciprocating blade 1ea	38,41	04	-
6 39 03 161 01 4	4014586198934	Cleaning blades	73,17	04	-
6 39 03 161 03 0	4014586315072	Reciprocating blade	329,27	04	-
6 39 03 162 01 7	4014586198958	Reciprocating blade 1ea	68,25	04	237
6 39 03 162 03 0	4014586315089	Reciprocating blade	307,13	04	237
6 39 03 163 01 1	4014586200729	Blade, U-shape, 2-pack	76,05	04	243
6 39 03 165 21 0	4014586389653	1 Sanding plate with holes SL	7,99	04	226
6 39 03 166 01 6	4014586208862	Reciprocating blades	63,01	04	236
6 39 03 167 05 4	4014586210889	Blade kit, BMW	214,36	04	-
6 39 03 167 25 7	4014586240794	Set for automobiles/car glaziers	199,67	04	245
6 39 03 167 32 0	4014586252445	Blade, accessory kits for auto glaziers, cargo and automobile workshops, 2-pack	199,67	04	245
6 39 03 167 38 3	4014586265032	Automotive glazier set	199,67	04	245
6 39 03 167 40 2	4014586268170	Carpenters Set	103,51	04	-
6 39 03 167 58 0	4014586307503	Accessory set for tile restoration/bathroom renovation	169,05	04	238
6 39 03 167 59 0	4014586307510	Accessory set for heating/sanitary installation	169,05	04	238
6 39 03 167 66 0	4014586343549	Accessory set for interior construction work with wood	169,05	04	238
6 39 03 167 67 0	4014586343556	Accessory set for repairing/replacing windows	169,05	04	238
6 39 03 168 01 8	4014586210247	Blade, straight, 2-pack	68,68	04	244
6 39 03 169 01 2	4014586210261	Blade, straight, 2-pack	96,43	04	244
6 39 03 170 01 4	4014586210285	Blade, straight, 2-pack	96,43	04	244
6 39 03 171 01 3	4014586210308	Blade, straight, 2-pack	68,68	04	244
6 39 03 172 01 6	4014586211978	Blade, straight, 2-pack	47,53	04	244
6 39 03 173 01 0	4014586211985	Blade, straight, 2-pack	73,91	04	244
6 39 03 174 01 8	4014586213736	Blade, straight, 2-pack	73,91	04	244
6 39 03 176 01 5	4014586214245	Blade, straight, 2-pack	48,58	04	244
6 39 03 177 01 9	4014586214252	Blade, straight, 2-pack	70,39	04	244
6 39 03 181 01 2	4014586215785	Blade, straight, 2-pack	73,91	04	244
6 39 03 182 01 5	4014586216010	Blade, straight, 2-pack	79,73	04	244
6 39 03 183 01 9	4014586216539	Cutter blade, 2-pack	59,92	04	-
6 39 03 184 01 7	4014586216546	Cutter blade, 2-pack	59,92	04	-
6 39 03 185 01 1	4014586216553	Cutter blade, 2-pack	59,92	04	-
6 39 03 186 01 4	4014586216560	Cutter blade, 2-pack	59,92	04	-
6 39 03 191 01 1	4014586217376	Blade, U-shape, 2-pack	76,05	04	243



Part number	EAN	Description	Price in €	PC	Page
6 39 03 194 01 6	4014586221878	Blade, straight, 2-pack	79,73	04	244
6 39 03 194 03 0	4014586269030	Reciprocating blade 1ea	39,65	04	-
6 39 03 195 01 0	4014586223513	Blade, curved, 2-pack	96,43	04	244
6 39 03 196 01 3	4014586222974	Reciprocating blade 1ea	68,25	04	237
6 39 03 196 02 0	4014586315096	Reciprocating blade	307,13	04	237
6 39 03 197 01 7	4014586223506	Blade, straight, 2-pack	80,89	04	242
6 39 03 198 01 5	4014586223469	Blade, straight, 2-pack	96,43	04	244
6 39 03 200 21 0	4014586389660	Cutting blade SLP	32,73	04	226
6 39 03 201 21 0	4014586389677	Cutting blade SLP	32,73	04	226
6 39 03 202 21 0	4014586389684	Cutting blade SLP	32,73	04	226
6 39 03 203 01 3	4014586228488	Reciprocating blades	70,39	04	244
6 39 03 206 01 8	4014586240930	Squeegee, 2/pack	20,21	04	237
6 39 03 207 01 2	4014586240947	Blade, L-shape, 2-pack	48,90	04	243
6 39 03 208 01 0	4014586240954	Blade, L-shape, 2-pack	48,90	04	243
6 39 03 209 01 4	4014586245133	Blade, L-shape, 2-pack	48,90	04	243
6 39 03 210 01 6	4014586245140	Blade, U-shape, 2-pack	48,13	04	243
6 39 03 211 01 5	4014586245157	Blade, U-shape, 2-pack	48,13	04	243
6 39 03 212 01 8	4014586245164	Blade, U-shape, 2-pack	48,13	04	243
6 39 03 216 01 7	4014586258164	Cutter blade, straight, 2-pack	67,34	04	244
6 39 03 216 02 0	4014586324302	Reciprocating blade	1.666,29	04	-
6 39 03 217 01 1	4014586265810	Blade, hooked, 2-pack	48,13	04	245
6 39 03 220 01 0	4014586274508	Circular blade, single	53,93	04	-
6 39 03 221 01 0	4014586291970	Tilers cutting blade 2-pack	33,31	04	237
6 39 03 222 01 0	4014586293905	Tilers cutting blade 2-pack	33,31	04	237
6 39 03 223 01 0	4014586293912	Tilers cutting blade 2-pack	33,31	04	237
6 39 03 224 01 0	4014586294223	HM Segment saw blade	36,75	04	236
6 39 03 224 02 0	4014586294247	HM Segment saw blade, 5-pack	165,38	04	236
6 39 03 225 01 0	4014586294254	HM Segment saw blade	36,75	04	236
6 39 03 225 02 0	4014586294261	HM Segment saw blade, 5-pack	165,38	04	236
6 39 03 226 21 0	4014586389691	Fixed Scraper Blade SL 34 x 52	14,74	04	226
6 39 03 227 01 0	4014586342078	Squeegee, 2/pack	20,51	04	237
6 39 03 228 01 0	4014586341507	Cutting tool	14,11	04	237
6 39 03 229 01 0	4014586341514	Cutting tool	14,11	04	237
6 39 03 230 01 0	4014586341521	Cutting tool	14,11	04	237
6 39 03 231 01 0	4014586341538	Cutting tool	14,11	04	237
6 39 03 233 21 0	4014586389707	Cutting blade SLP	32,73	04	226
6 39 03 234 21 0	4014586389714	Fixed Scraper Blade SLP 41 x 52	14,99	04	226
6 39 03 235 21 0	4014586389721	HSS circular knife SLP Ø 100	52,87	04	226
6 39 03 236 23 0	4014586389776	Cutting blade SLM 60 x 30 (5)	21,24	04	229
6 39 03 237 21 0	4014586391175	Diamond cleaning knife SLM 60 x 31 (1)	73,17	04	229
6 39 03 237 23 0	4014586391182	Diamond cleaning knife SLM 60 x 31 (5)	329,27	04	229
6 39 03 238 21 0	4014586389738	Cutting blade SLM 68 x 1 (1)	21,32	04	229
6 39 03 239 23 0	4014586389745	Cutting blade SLM 60 x 2 (5)	68,15	04	229
6 39 03 240 21 0	4014586391199	Carbide saw blade segmented SLM 1,2 (1)	36,75	04	228
6 39 03 240 23 0	4014586391205	Carbide saw blade segmented SLM 1,2 (5)	165,38	04	228
6 39 03 241 21 0	4014586391212	Carbide saw blade segmented SLM 2,2 (1)	36,75	04	228
6 39 03 241 23 0	4014586391229	Carbide saw blade segmented SLM 2,2 (5)	165,38	04	228
6 39 03 242 21 0	4014586391236	Diamond-coated saw blade segmented SLM 1,2 (1)	68,25	04	229
6 39 03 242 23 0	4014586391243	Diamond-coated saw blade segmented SLM 1,2 (5)	307,13	04	229
6 39 03 243 21 0	4014586391250	Diamond-coated saw blade segmented SLM 2,2 (1)	68,25	04	229
6 39 03 243 23 0	4014586391267	Diamond-coated saw blade segmented SLM 2,2 (5)	307,13	04	229
6 39 03 244 22 0	4014586389783	segmented SLM 42,63 (2)	63,01	04	228
6 39 03 245 23 0	4014586389752	Cutting blade mushroom-shaped SL (5)	26,15	04	226
6 39 03 246 22 0	4014586392615	Cutting tool	40,01	04	229
6 39 03 247 22 0	4014586392622	Cutting tool	40,01	04	229
6 39 03 248 22 0	4014586392639	Cutting tool	40,01	04	229
6 39 03 251 21 0	4014586409276	SL Multi-function knife	19,85	04	226
6 39 03 251 23 0	4014586409283	SL Multi-function knife	89,30	04	226
6 39 98 611 03 0	4014586621241	Protecting lattice	27,11	02	-
6 40 01 010 00 2	4014586217314	Grinding gauge	16,77	02	-
6 41 31 019 01 0	4014586369877	Vice installation kit	26,15	02	75
6 42 01 001 00 0	4014586307305	Hook f. chip removal	36,26	02	-
6 42 01 005 01 0	4014586376554	Magbrush	42,61	02	157
6 42 03 001 00 0	4014586325118	Holder	4,60	02	-
6 42 03 002 01 0	4014586404844	Socket adapter	31,06	02	15
6 42 03 003 01 0	4014586404851	Tapping adapter	73,90	02	15
6 42 03 004 01 0	4014586404547	Extension	52,50	02	35
6 42 03 005 01 0	4014586404554	Extension	105,00	02	35
6 42 04 001 01 0	4014586351988	Cutting wire	32,72	02	59
6 42 04 002 01 0	4014586354354	Anti-Metal-Cut set	18,07	02	59
6 42 04 003 01 0	4014586371177	Extension	76,89	02	59
6 99 02 000 00 0	4014586277479	Dust collector	85,72	13	265
6 99 02 000 14 7	4014586364636	Device for dust extract	337,55	13	265
6 99 02 000 14 8	4014586369129	Stainless steel sanding support	148,56	13	265
6 99 02 000 14 9	4014586369136	Stainless steel sanding support	170,42	13	266
6 99 02 000 15 0	4014586369143	Mitre joint unit for preparation of welded seams	196,63	13	265

Accessories in numerical order

Part number	EAN	Description	Price in €	PC	Page
6 99 02 000 15 1	4014586369150	Mitre joint unit for preparation of welded seams	218,48	13	266
6 99 02 000 18 7	4014586372655	Contact roller Ø 193,7/150	441,00	13	266
6 99 02 000 40 9	4014586405292	Contact roller Ø 16,0 /50	58,80	13	251
6 99 02 000 41 0	4014586405308	Contact roller Ø 18,0 /50	58,80	13	251
6 99 02 000 41 1	4014586405315	Contact roller Ø 19,0 /50	58,80	13	251
6 99 02 000 41 2	4014586405322	Contact roller Ø 20,0 /50	58,80	13	251
6 99 02 000 41 3	4014586405339	Contact roller Ø 21,0 /50	58,80	13	251
6 99 02 000 41 4	4014586405346	Contact roller Ø 21,3 /50	58,80	13	251
6 99 02 000 41 5	4014586405353	Contact roller Ø 22,0 /50	58,80	13	251
6 99 02 000 41 6	4014586405360	Contact roller Ø 25,0 /50	58,80	13	251
6 99 02 000 41 7	4014586405377	Contact roller Ø 25,4 /50	58,80	13	251
6 99 02 000 41 8	4014586405384	Contact roller Ø 26,0 /50	58,80	13	251
6 99 02 000 41 9	4014586405391	Contact roller Ø 26,9 /50	58,80	13	251
6 99 02 000 42 0	4014586405407	Contact roller Ø 27,0 /50	58,80	13	251
6 99 02 000 42 1	4014586405414	Contact roller Ø 28,0 /50	58,80	13	251
6 99 02 000 42 2	4014586405421	Contact roller Ø 28,8 /50	58,80	13	251
6 99 02 000 42 3	4014586405438	Contact roller Ø 30,0 /50	58,80	13	251
6 99 02 000 42 4	4014586405445	Contact roller Ø 31,7 /50	58,80	13	251
6 99 02 000 42 5	4014586405452	Contact roller Ø 32,0 /50	58,80	13	251
6 99 02 000 42 6	4014586405469	Contact roller Ø 33,0 /50	58,80	13	251
6 99 02 000 42 7	4014586405476	Contact roller Ø 33,7 /50	58,80	13	251
6 99 02 000 42 8	4014586405483	Contact roller Ø 34,0 /50	58,80	13	251
6 99 02 000 42 9	4014586405490	Contact roller Ø 35,0 /50	58,80	13	251
6 99 02 000 43 0	4014586405506	Contact roller Ø 38,0 /50	58,80	13	251
6 99 02 000 43 1	4014586405513	Contact roller Ø 38,1 /50	58,80	13	251
6 99 02 000 43 2	4014586405520	Contact roller Ø 38,3 /50	58,80	13	251
6 99 02 000 43 3	4014586405537	Contact roller Ø 40,0 /50	58,80	13	251
6 99 02 000 43 4	4014586405544	Contact roller Ø 42,0 /50	58,80	13	251
6 99 02 000 43 5	4014586405551	Contact roller Ø 42,4 /50	58,80	13	251
6 99 02 001 00 0	4014586277486	Length stop	138,60	13	264
6 99 02 002 00 0	4014586277493	Connector	92,85	02	-
6 99 02 004 00 0	4014586277516	Stainless steel jaws for GXR	129,87	06	264
6 99 02 006 00 0	4014586277530	Steel brush Ø 250 x 60 x 34 x 0.2 mm	168,35	12	265
6 99 02 007 00 0	4014586277547	Steel brush Ø 250 x 60 x 34x 0.35 mm	153,99	12	265
6 99 02 008 00 0	4014586277554	Steel brush Ø 250 x 60 x 34x 0.5 mm	153,99	12	265
6 99 02 009 00 0	4014586277561	Stainless steel brush Ø 250 x 60 x 34 x 0.2 mm	297,56	12	265
6 99 02 010 00 0	4014586277578	Stainless steel brush Ø 250 x 60 x 34 x 0.35 mm	259,70	12	265
6 99 02 020 00 0	4014586277677	Contact roller Ø 16.0 /75	88,27	13	264
6 99 02 021 00 0	4014586277684	Contact roller Ø 17.0 /75	88,27	13	264
6 99 02 022 00 0	4014586277691	Contact roller Ø 17.2 /75	88,27	13	264
6 99 02 023 00 0	4014586277707	Contact roller Ø 18.0 /75	88,27	13	264
6 99 02 024 00 0	4014586277714	Contact roller Ø 19.0 /75	88,27	13	264
6 99 02 025 00 0	4014586277721	Contact roller Ø 20.0 /75	88,27	13	264
6 99 02 026 00 0	4014586277738	Contact roller Ø 21.0 /75	88,27	13	264
6 99 02 027 00 0	4014586277745	Contact roller Ø 21.3 /75	88,27	13	264
6 99 02 028 00 0	4014586277752	Contact roller Ø 22.0 /75	88,27	13	264
6 99 02 029 00 0	4014586277769	Contact roller Ø 22.2 /75	88,27	13	264
6 99 02 030 00 0	4014586277776	Contact roller Ø 22.5 /75	88,27	13	264
6 99 02 031 00 0	4014586277783	Contact roller Ø 23.0 /75	88,27	13	264
6 99 02 032 00 0	4014586277790	Contact roller Ø 23.1 /75	88,27	13	264
6 99 02 033 00 0	4014586277806	Contact roller Ø 24.0 /75	88,27	13	264
6 99 02 034 00 0	4014586277813	Contact roller Ø 24.5 /75	88,27	13	264
6 99 02 035 00 0	4014586277820	Contact roller Ø 25.0 /75	88,27	13	264
6 99 02 036 00 0	4014586277837	Contact roller Ø 25.4 /75	88,27	13	264
6 99 02 037 00 0	4014586277844	Contact roller Ø 25.9 /75	88,27	13	264
6 99 02 038 00 0	4014586277851	Contact roller Ø 26.0 /75	88,27	13	264
6 99 02 039 00 0	4014586277868	Contact roller Ø 26.4 /75	88,27	13	264
6 99 02 040 00 0	4014586277875	Contact roller Ø 26.9 /75	88,27	13	264
6 99 02 041 00 0	4014586277882	Contact roller Ø 27.0 /75	88,27	13	264
6 99 02 042 00 0	4014586277899	Contact roller Ø 28.0 /75	88,27	13	264
6 99 02 043 00 0	4014586277905	Contact roller Ø 28.6 /75	88,27	13	264
6 99 02 044 00 0	4014586277912	Contact roller Ø 28.8 /75	88,27	13	264
6 99 02 045 00 0	4014586277929	Contact roller Ø 29.0 /75	88,27	13	264
6 99 02 046 00 0	4014586277936	Contact roller Ø 30.0 /75	88,27	13	264
6 99 02 047 00 0	4014586277943	Contact roller Ø 31.7 /75	88,27	13	264
6 99 02 048 00 0	4014586277950	Contact roller Ø 32.0 /75	88,27	13	264
6 99 02 049 00 0	4014586277967	Contact roller Ø 33.0 /75	88,27	13	264
6 99 02 050 00 0	4014586277974	Contact roller Ø 33.7 /75	88,27	13	264
6 99 02 051 00 0	4014586277981	Contact roller Ø 34.0 /75	88,27	13	264
6 99 02 052 00 0	4014586277998	Contact roller Ø 35.0 /75	88,27	13	264
6 99 02 053 00 0	4014586278001	Contact roller Ø 36.0 /75	88,27	13	264
6 99 02 054 00 0	4014586278018	Contact roller Ø 37.5 /75	88,27	13	264
6 99 02 055 00 0	4014586278025	Contact roller Ø 38.0 /75	88,27	13	264
6 99 02 056 00 0	4014586278032	Contact roller Ø 38.1 /75	88,27	13	264
6 99 02 057 00 0	4014586278049	Contact roller Ø 38.3 /75	88,27	13	264
6 99 02 058 00 0	4014586278056	Contact roller Ø 40.0 /75	88,27	13	264





Part number	EAN	Description	Price in €	PC	Page
6 99 02 059 00 0	4014586278063	Contact roller Ø 41.0 /75	88,27	13	264
6 99 02 060 00 0	4014586278070	Contact roller Ø 41.2 /75	88,27	13	264
6 99 02 061 00 0	4014586278087	Contact roller Ø 42.0 /75	88,27	13	264
6 99 02 062 00 0	4014586278094	Contact roller Ø 42.4 /75	88,27	13	264
6 99 02 063 00 0	4014586278100	Contact roller Ø 42.6 /75	88,27	13	264
6 99 02 064 00 0	4014586278117	Contact roller Ø 43.0 /75	88,27	13	264
6 99 02 065 00 0	4014586278124	Contact roller Ø 43.3 /75	88,27	13	264
6 99 02 066 00 0	4014586278131	Contact roller Ø 44.0 /75	88,27	13	264
6 99 02 067 00 0	4014586278148	Contact roller Ø 44.5 /75	88,27	13	264
6 99 02 068 00 0	4014586278155	Contact roller Ø 45.0 /75	88,27	13	264
6 99 02 069 00 0	4014586278162	Contact roller Ø 46.0 /75	88,27	13	264
6 99 02 070 00 0	4014586278179	Contact roller Ø 48.0 /75	88,27	13	264
6 99 02 071 00 0	4014586278186	Contact roller Ø 48.3 /75	88,27	13	264
6 99 02 072 00 0	4014586278193	Contact roller Ø 49.0 /75	88,27	13	264
6 99 02 073 00 0	4014586278209	Contact roller Ø 50.0 /75	88,27	13	264
6 99 02 074 00 0	4014586278216	Contact roller Ø 50.8 /75	108,75	13	264
6 99 02 075 00 0	4014586278223	Contact roller Ø 51.0 /75	108,75	13	264
6 99 02 076 00 0	4014586278230	Contact roller Ø 53.0 /75	108,75	13	264
6 99 02 077 00 0	4014586278247	Contact roller Ø 53.7 /75	108,75	13	264
6 99 02 078 00 0	4014586278254	Contact roller Ø 54.0 /75	108,75	13	264
6 99 02 079 00 0	4014586278261	Contact roller Ø 55.0 /75	108,75	13	264
6 99 02 080 00 0	4014586278278	Contact roller Ø 57.0 /75	108,75	13	264
6 99 02 081 00 0	4014586278285	Contact roller Ø 58.0 /75	108,75	13	264
6 99 02 082 00 0	4014586278292	Contact roller Ø 59.0 /75	108,75	13	264
6 99 02 083 00 0	4014586278308	Contact roller Ø 60.0 /75	108,75	13	264
6 99 02 084 00 0	4014586278315	Contact roller Ø 60.3 /75	108,75	13	264
6 99 02 085 00 0	4014586278322	Contact roller Ø 63.0 /75	108,75	13	264
6 99 02 086 00 0	4014586278339	Contact roller Ø 63.5 /75	108,75	13	264
6 99 02 087 00 0	4014586278346	Contact roller Ø 65.0 /75	108,75	13	264
6 99 02 088 00 0	4014586278353	Contact roller Ø 67.0 /75	108,75	13	264
6 99 02 089 00 0	4014586278360	Contact roller Ø 69.0 /75	108,75	13	264
6 99 02 090 00 0	4014586278377	Contact roller Ø 70.0 /75	108,75	13	264
6 99 02 091 00 0	4014586278384	Contact roller Ø 73.0 /75	108,75	13	264
6 99 02 092 00 0	4014586278391	Contact roller Ø 75.0 /75	108,75	13	264
6 99 02 093 00 0	4014586278407	Contact roller Ø 76.0 /75	124,10	13	264
6 99 02 094 00 0	4014586278414	Contact roller Ø 76.1 /75	124,10	13	264
6 99 02 095 00 0	4014586278421	Contact roller Ø 76.2 /75	124,10	13	264
6 99 02 096 00 0	4014586278438	Contact roller Ø 80.0 /75	124,10	13	264
6 99 02 097 00 0	4014586278445	Contact roller Ø 82.5 /75	124,10	13	264
6 99 02 098 00 0	4014586278452	Contact roller Ø 88.9 /75	124,10	13	264
6 99 02 099 00 0	4014586278469	Contact roller Ø 90.0 /75	124,10	13	264
6 99 02 100 00 0	4014586278476	Grinding/cooling emulsion 10 litre	249,49	13	265
6 99 02 101 00 0	4014586283098	Contact roller Ø 20.0 /150	126,68	13	266
6 99 02 102 00 0	4014586283104	Contact roller Ø 22.0 /150	126,68	13	266
6 99 02 103 00 0	4014586283111	Contact roller Ø 25.0 /150	126,68	13	266
6 99 02 104 00 0	4014586283128	Contact roller Ø 25.4 /150	126,68	13	266
6 99 02 105 00 0	4014586283135	Contact roller Ø 26.9 /150	126,68	13	266
6 99 02 106 00 0	4014586283142	Contact roller Ø 28.0 /150	126,68	13	266
6 99 02 107 00 0	4014586283159	Contact roller Ø 30.0 /150	126,68	13	266
6 99 02 108 00 0	4014586283166	Contact roller Ø 32.0 /150	126,68	13	266
6 99 02 109 00 0	4014586283173	Contact roller Ø 33.7 /150	126,68	13	266
6 99 02 110 00 0	4014586283180	Contact roller Ø 35.0 /150	126,68	13	266
6 99 02 111 00 0	4014586283197	Contact roller Ø 38.0 /150	126,68	13	266
6 99 02 112 00 0	4014586283203	Contact roller Ø 38.1 /150	126,68	13	266
6 99 02 113 00 0	4014586283210	Contact roller Ø 38.3 /150	126,68	13	266
6 99 02 114 00 0	4014586283227	Contact roller Ø 40.0 /150	126,68	13	266
6 99 02 115 00 0	4014586283234	Contact roller Ø 42.4 /150	126,68	13	266
6 99 02 116 00 0	4014586283241	Contact roller Ø 44.5 /150	126,68	13	266
6 99 02 117 00 0	4014586283258	Contact roller Ø 48.3 /150	126,68	13	266
6 99 02 118 00 0	4014586283265	Contact roller Ø 50.0 /150	126,68	13	266
6 99 02 119 00 0	4014586283272	Contact roller Ø 50.8 /150	144,57	13	266
6 99 02 120 00 0	4014586283289	Contact roller Ø 60.0 /150	144,57	13	266
6 99 02 121 00 0	4014586283296	Contact roller Ø 60.3 /150	144,57	13	266
6 99 02 122 00 0	4014586283302	Contact roller Ø 63.5 /150	144,57	13	266
6 99 02 123 00 0	4014586283319	Contact roller Ø 69.0 /150	144,57	13	266
6 99 02 124 00 0	4014586283326	Contact roller Ø 76.1 /150	198,31	13	266
6 99 02 125 00 0	4014586283333	Contact roller Ø 76.2 /150	198,31	13	266
6 99 02 126 00 0	4014586283340	Contact roller Ø 84.0 /150	198,31	13	266
6 99 02 127 00 0	4014586283357	Contact roller Ø 88.9 /150	198,31	13	266
6 99 02 128 00 0	4014586283364	Contact roller Ø 101.6 /150	198,31	13	266
6 99 02 129 00 0	4014586283371	Contact roller Ø 104.0 /150	271,25	13	266
6 99 02 130 00 0	4014586283388	Contact roller Ø 108.0 /150	271,25	13	266
6 99 02 131 00 0	4014586283395	Contact roller Ø 114.3 /150	271,25	13	266
6 99 02 132 00 0	4014586283401	Contact roller Ø 133.0 /150	598,76	13	266
6 99 02 133 00 0	4014586283418	Contact roller Ø 139.7 /150	598,76	13	266
6 99 02 134 00 0	4014586283425	Contact roller Ø 168.3 /150	655,06	13	266



Part number	EAN	Description	Price in €	PC	Page
6 99 02 136 00 0	4014586284613	Classic	124,95	13	-
6 99 02 155 00 0	4014586284835	Contact roller Ø 152.4 / 150	640,98	13	-
6 99 02 158 00 0	4014586284934	Classic	137,55	13	-
6 99 02 160 00 0	4014586284972	Classic	466,20	13	-
6 99 02 161 00 0	4014586284989	Contact grinding kit for GU150DS/2H	466,20	13	-
6 99 02 162 00 0	4014586284996	Classic	227,85	13	-
6 99 02 163 00 0	4014586285009	Clamping jaws for vice GU	182,70	13	-
6 99 02 165 00 0	4014586285023	Fixing unit for roller support	105,00	13	-
6 99 02 169 00 0	4014586285061	Classic	150,15	13	-
6 99 02 172 00 0	4014586285092	Classic	366,45	13	-
6 99 02 175 00 0	4014586285511	Mitre grinding plate GIG	280,35	13	266
6 99 02 176 00 0	4014586285528	Swivel joint GIT for GIL	247,80	13	267
6 99 02 179 60 0	4014586349381	Pipe support	207,61	13	265
6 99 02 180 00 0	4014586285566	Fittings for angle support	116,55	13	-
6 99 02 180 60 0	4014586351193	Pipe support	337,55	13	265
6 99 02 181 60 0	4014586351209	Pipe support	843,90	13	265
6 99 02 182 00 0	4014586285580	Suction socket for GIR	135,45	13	266
6 99 02 183 00 0	4014586285597	Plugbox 2 x 7 poles	109,20	13	267
6 99 02 186 00 0	4014586288499	Connecting piece	70,35	13	264
6 99 02 187 00 0	4014586288482	Connecting piece	82,95	13	265
6 99 02 188 00 0	4014586290683	Contact roller Ø 16.0 /150	126,68	13	-
6 99 02 189 00 0	4014586290706	Contact roller Ø 18.0 /150	126,68	13	-
6 99 02 190 00 0	4014586290713	Contact roller Ø 19.0 /150	126,68	13	-
6 99 02 191 00 0	4014586290720	Contact roller Ø 19.1 /150	126,68	13	-
6 99 02 192 00 0	4014586290737	Contact roller Ø 21.0 /150	126,68	13	-
6 99 02 193 00 0	4014586290744	Contact roller Ø 21.3 /150	126,68	13	-
6 99 02 194 00 0	4014586290751	Contact roller Ø 22.3 /150	126,68	13	-
6 99 02 195 00 0	4014586290768	Contact roller Ø 23.0 /150	126,68	13	-
6 99 02 196 00 0	4014586290775	Contact roller Ø 23.2 /150	126,68	13	-
6 99 02 197 00 0	4014586290782	Contact roller Ø 24.3 /150	126,68	13	-
6 99 02 198 00 0	4014586290799	Contact roller Ø 26.1 /150	126,68	13	-
6 99 02 199 00 0	4014586290805	Contact roller Ø 26.7 /150	126,68	13	-
6 99 02 200 00 0	4014586290812	Contact roller Ø 27.0 /150	126,68	13	-
6 99 02 201 00 0	4014586290829	Contact roller Ø 28.3 /150	126,68	13	-
6 99 02 202 00 0	4014586290836	Contact roller Ø 28.6 /150	126,68	13	-
6 99 02 203 00 0	4014586290843	Contact roller Ø 29.2 /150	126,68	13	-
6 99 02 204 00 0	4014586290850	Contact roller Ø 31.1 /150	126,68	13	-
6 99 02 205 00 0	4014586290867	Contact roller Ø 31.5 /150	126,68	13	-
6 99 02 206 00 0	4014586290874	Contact roller Ø 31.8 /150	126,68	13	-
6 99 02 207 00 0	4014586290881	Contact roller Ø 33.0 /150	126,68	13	-
6 99 02 208 00 0	4014586290898	Contact roller Ø 33.4 /150	126,68	13	-
6 99 02 209 00 0	4014586290904	Contact roller Ø 34.0 /150	126,68	13	-
6 99 02 210 00 0	4014586290911	Contact roller Ø 37.4 /150	126,68	13	-
6 99 02 211 00 0	4014586290928	Contact roller Ø 39.8 /150	126,68	13	-
6 99 02 212 00 0	4014586290935	Contact roller Ø 40.1 /150	126,68	13	-
6 99 02 213 00 0	4014586290942	Contact roller Ø 41.3 /150	126,68	13	-
6 99 02 214 00 0	4014586290959	Contact roller Ø 42.0 /150	126,68	13	-
6 99 02 215 00 0	4014586290966	Contact roller Ø 42.1 /150	126,68	13	-
6 99 02 216 00 0	4014586290973	Contact roller Ø 42.2 /150	126,68	13	-
6 99 02 217 00 0	4014586290980	Contact roller Ø 43.0 /150	126,68	13	-
6 99 02 218 00 0	4014586290997	Contact roller Ø 45.0 /150	126,68	13	-
6 99 02 219 00 0	4014586291000	Contact roller Ø 45.7 /150	126,68	13	-
6 99 02 221 00 0	4014586291024	Contact roller Ø 47.4 /150	126,68	13	-
6 99 02 222 00 0	4014586291031	Contact roller Ø 48.0 /150	126,68	13	-
6 99 02 223 00 0	4014586291048	Contact roller Ø 49.0 /150	126,68	13	-
6 99 02 224 00 0	4014586291055	Contact roller Ø 50.1 /150	144,57	13	-
6 99 02 225 00 0	4014586291062	Contact roller Ø 51.0 /150	144,57	13	-
6 99 02 226 00 0	4014586291086	Contact roller Ø 52.0 /150	144,57	13	-
6 99 02 227 00 0	4014586291093	Contact roller Ø 93.2 /150	198,31	13	-
6 99 02 228 00 0	4014586291109	Contact roller Ø 107.0 /150	283,12	13	-
6 99 02 229 00 0	4014586291116	Contact roller Ø 54.0 /150	144,57	13	-
6 99 02 230 00 0	4014586291123	Contact roller Ø 55.0 /150	144,57	13	-
6 99 02 231 00 0	4014586291130	Contact roller Ø 57.0 /150	144,57	13	-
6 99 02 232 00 0	4014586291147	Contact roller Ø 57.8 /150	144,57	13	-
6 99 02 233 00 0	4014586291154	Contact roller Ø 58.0 /150	144,57	13	-
6 99 02 234 00 0	4014586291161	Contact roller Ø 59.5 /150	144,57	13	-
6 99 02 235 00 0	4014586291178	Contact roller Ø 62.0 /150	144,57	13	-
6 99 02 236 00 0	4014586291185	Contact roller Ø 63.0 /150	144,57	13	-
6 99 02 237 00 0	4014586291192	Contact roller Ø 64.2 /150	144,57	13	-
6 99 02 238 00 0	4014586291208	Contact roller Ø 65.0 /150	144,57	13	-
6 99 02 239 00 0	4014586291215	Contact roller Ø 66.0 /150	144,57	13	-
6 99 02 240 00 0	4014586291222	Contact roller Ø 66.3 /150	144,57	13	-
6 99 02 241 00 0	4014586291239	Contact roller Ø 66.7 /150	144,57	13	-
6 99 02 242 00 0	4014586291246	Contact roller Ø 67.1 /150	144,57	13	-
6 99 02 243 00 0	4014586291253	Contact roller Ø 69.9 /150	144,57	13	-
6 99 02 244 00 0	4014586291260	Contact roller Ø 70.0 /150	144,57	13	-



Part number	EAN	Description	Price in €	PC	Page
6 99 02 245 00 0	4014586291277	Contact roller Ø 73.0 /150	144,57	13	-
6 99 02 246 00 0	4014586291284	Contact roller Ø 73.8 /150	144,57	13	-
6 99 02 247 00 0	4014586291291	Contact roller Ø 75.0 /150	144,57	13	-
6 99 02 248 00 0	4014586291307	Contact roller Ø 75.1 /150	198,31	13	-
6 99 02 249 00 0	4014586291314	Contact roller Ø 76.0 /150	198,31	13	-
6 99 02 250 00 0	4014586291321	Contact roller Ø 78.0 /150	198,31	13	-
6 99 02 251 00 0	4014586291338	Contact roller Ø 79.4 /150	198,31	13	-
6 99 02 252 00 0	4014586291345	Contact roller Ø 79.8 /150	198,31	13	-
6 99 02 253 00 0	4014586291352	Contact roller Ø 80.0 /150	198,31	13	-
6 99 02 254 00 0	4014586291369	Contact roller Ø 80.2 /150	198,31	13	-
6 99 02 255 00 0	4014586291376	Contact roller Ø 81.0 /150	198,31	13	-
6 99 02 256 00 0	4014586291383	Contact roller Ø 82.0 /150	198,31	13	-
6 99 02 257 00 0	4014586291390	Contact roller Ø 82.1 /150	198,31	13	-
6 99 02 258 00 0	4014586291406	Contact roller Ø 82.5 /150	198,31	13	-
6 99 02 259 00 0	4014586291413	Contact roller Ø 83.0 /150	198,31	13	-
6 99 02 260 00 0	4014586291420	Contact roller Ø 84.1 /150	198,31	13	-
6 99 02 261 00 0	4014586291437	Contact roller Ø 85.0 /150	198,31	13	-
6 99 02 262 00 0	4014586291444	Contact roller Ø 86.7 /150	198,31	13	-
6 99 02 263 00 0	4014586291451	Contact roller Ø 87.0 /150	198,31	13	-
6 99 02 264 00 0	4014586291468	Contact roller Ø 88.0 /150	198,31	13	-
6 99 02 265 00 0	4014586291475	Contact roller Ø 89.0 /150	198,31	13	-
6 99 02 266 00 0	4014586291482	Contact roller Ø 89.3 /150	198,31	13	-
6 99 02 267 00 0	4014586291499	Contact roller Ø 89.9 /150	198,31	13	-
6 99 02 268 00 0	4014586291505	Contact roller Ø 90.0 /150	198,31	13	-
6 99 02 269 00 0	4014586291512	Contact roller Ø 92.0 /150	198,31	13	-
6 99 02 271 00 0	4014586291543	Contact roller Ø 100.0 /150	198,31	13	-
6 99 02 272 00 0	4014586291635	Contact roller Ø 100.5 /150	198,31	13	-
6 99 02 273 00 0	4014586291642	Contact roller Ø 101.0 /150	198,31	13	-
6 99 02 274 00 0	4014586291659	Contact roller Ø 101.3 /150	198,31	13	-
6 99 02 275 00 0	4014586291987	Contact roller Ø 102.0 /150	198,31	13	-
6 99 02 276 00 0	4014586291994	Contact roller Ø 102.5 /150	198,31	13	-
6 99 02 277 00 0	4014586292007	Contact roller Ø 102.6 /150	276,15	13	-
6 99 02 278 00 0	4014586292014	Contact roller Ø 105.0 /150	276,15	13	-
6 99 02 279 00 0	4014586292021	Contact roller Ø 106.7 /150	276,15	13	-
6 99 02 281 00 0	4014586292045	Contact roller Ø 110.0 /150	276,15	13	-
6 99 02 282 00 0	4014586292052	Contact roller Ø 114.0 /150	276,15	13	-
6 99 02 283 00 0	4014586292069	Contact roller Ø 115.0 /150	276,15	13	-
6 99 02 284 00 0	4014586292076	Contact roller Ø 117.0 /150	276,15	13	-
6 99 02 285 00 0	4014586292083	Contact roller Ø 118.0 /150	276,15	13	-
6 99 02 286 00 0	4014586292090	Contact roller Ø 118.2 /150	276,15	13	-
6 99 02 287 00 0	4014586292106	Contact roller Ø 120.0 /150	276,15	13	-
6 99 02 288 00 0	4014586292113	Contact roller Ø 121.0 /150	276,15	13	-
6 99 02 289 00 0	4014586293080	Contact roller Ø 122.0 /150	276,15	13	-
6 99 02 290 00 0	4014586292120	Contact roller Ø 124.0 /150	276,15	13	-
6 99 02 291 00 0	4014586292137	Contact roller Ø 125.0 /150	276,15	13	-
6 99 02 292 00 0	4014586292144	Contact roller Ø 127.0 /150	276,15	13	-
6 99 02 293 00 0	4014586292151	Contact roller Ø 127.5 /150	276,15	13	-
6 99 02 294 00 0	4014586292168	Contact roller Ø 128.0 /150	276,15	13	-
6 99 02 295 00 0	4014586292175	Contact roller Ø 129.0 /150	276,15	13	-
6 99 02 296 00 0	4014586292182	Contact roller Ø 130.0 /150	276,15	13	-
6 99 02 297 00 0	4014586292199	Contact roller Ø 135.0 /150	611,10	13	-
6 99 02 298 00 0	4014586292205	Contact roller Ø 138.0 /150	611,10	13	-
6 99 02 299 00 0	4014586292212	Contact roller Ø 139.0 /150	611,10	13	-
6 99 02 300 00 0	4014586292229	Contact roller Ø 140.0 /150	632,10	13	-
6 99 02 301 00 0	4014586292236	Contact roller Ø 141.3 /150	632,10	13	-
6 99 02 302 00 0	4014586292243	Contact roller Ø 141.9 /150	632,10	13	-
6 99 02 303 00 0	4014586292250	Contact roller Ø 144.2 /150	632,10	13	-
6 99 02 304 00 0	4014586292267	Contact roller Ø 15.0 /150	88,27	13	-
6 99 02 305 00 0	4014586292274	Contact roller Ø 150.0 /150	654,15	13	-
6 99 02 306 00 0	4014586292281	Contact roller Ø 152.0 /150	654,15	13	-
6 99 02 308 00 0	4014586292304	Contact roller Ø 154.0 /150	654,15	13	-
6 99 02 309 00 0	4014586292311	Contact roller Ø 159.0 /150	654,15	13	-
6 99 02 310 00 0	4014586292328	Contact roller Ø 160.0 /150	667,80	13	-
6 99 02 311 00 0	4014586292335	Contact roller Ø 163.0 /150	667,80	13	-
6 99 02 312 00 0	4014586292342	Contact roller Ø 165.0 /150	667,80	13	-
6 99 02 313 00 0	4014586292359	Contact roller Ø 165.1 /150	667,80	13	-
6 99 02 314 00 0	4014586292366	Contact roller Ø 168.0 /150	667,80	13	-
6 99 02 315 00 0	4014586292373	Contact roller Ø 172.2 /150	697,20	13	-
6 99 02 316 00 0	4014586292380	Contact roller Ø 180.0 /150	441,00	13	-
6 99 02 317 00 0	4014586292397	Contact roller Ø 188.4 /150	441,00	13	-
6 99 02 318 00 0	4014586292403	Contact roller Ø 190.0 /150	441,00	13	-
6 99 02 319 00 0	4014586292410	Contact roller Ø 195.0 /150	441,00	13	-
6 99 02 320 00 0	4014586292427	Contact roller Ø 202.0 /150	407,40	13	-
6 99 02 321 00 0	4014586292533	Contact roller Ø 215.0 /150	478,80	13	-
6 99 02 322 00 0	4014586292540	Contact roller Ø 219.0 /150	478,80	13	-
6 99 02 323 00 0	4014586292557	Contact roller Ø 31.0 /150	88,27	13	-

Accessories in numerical order

Part number	EAN	Description	Price in €	PC	Page
6 99 02 324 00 0	4014586292564	Contact roller Ø 57.5 /150	108,75	13	-
6 99 02 326 00 0	4014586292588	Contact roller Ø 68.0	108,75	13	-
6 99 02 327 00 0	4014586292595	Contact roller Ø 84.0 /150	124,10	13	-
6 99 02 328 00 0	4014586295251	Guide arms, complete	664,65	13	-
6 99 02 332 00 0	4014586295435	Contact roller Ø 68.9 /150	144,57	13	-
6 99 02 333 00 0	4014586295718	Nylon roller support	378,00	13	-
6 99 02 335 00 0	4014586296609	Jawset vice	236,25	13	267
6 99 02 338 00 0	4014586299488	Stainless steel sanding support	132,65	13	264
6 99 02 343 00 0	4014586349398	Spark box with dust extraction	86,51	13	264
6 99 02 344 00 0	4014586349404	Stainless steel sanding support	46,13	13	265
6 99 02 346 00 0	4014586379296	Contact disc	251,66	13	267
6 99 02 410 00 0	4014586299310	Drive wheel puller	63,00	06	267
6 99 03 000 00 0	4014586278483	Grinding belt 75 x 2000 K24 R 10 each	129,99	12	262
6 99 03 002 00 0	4014586278506	Grinding belt 75 x 2000 K36 R 10 each	103,88	12	262
6 99 03 003 00 0	4014586278513	Grinding belt 75 x 2000 K36 Z 10 each	78,81	12	263
6 99 03 004 00 0	4014586278520	Grinding belt 75 x 2000 K40 R 10 each	98,65	12	262
6 99 03 005 00 0	4014586278537	Grinding belt 75 x 2000 K40 Z 10 each	74,85	12	263
6 99 03 007 00 0	4014586278551	Grinding belt 75 x 2000 K60 R 10 each	87,28	12	262
6 99 03 008 00 0	4014586278568	Grinding belt 75 x 2000 K60 Z 10 each	66,27	12	263
6 99 03 009 00 0	4014586278575	Grinding belt 75 x 2000 K80 R 10 each	82,01	12	262
6 99 03 010 00 0	4014586278582	Grinding belt 75 x 2000 K80 Z 10 each	62,30	12	263
6 99 03 013 00 0	4014586278612	Grinding belt 75 x 2000 K120 R 10 each	77,93	12	262
6 99 03 014 00 0	4014586278629	Grinding belt 75 x 2000 K120 Z 10 each	59,12	12	263
6 99 03 017 00 0	4014586278650	Grinding belt 75 x 2000 K220 A 10 each	57,58	12	263
6 99 03 018 00 0	4014586278667	Grinding belt 75 x 2000 K320 A 10 each	57,58	12	263
6 99 03 019 00 0	4014586278674	Grinding belt 75 x 2000 K400 A 10 each	57,58	12	263
6 99 03 020 00 0	4014586278681	Grinding belt 75 x 2250 K36 R 10 each	116,31	12	262
6 99 03 021 00 0	4014586278698	Grinding belt 75 x 2250 K36 Z 10 each	88,27	12	263
6 99 03 034 00 0	4014586283616	Grinding belt 100 x 1000 K36 Z 10 each	55,27	12	263
6 99 03 035 00 0	4014586283623	Grinding belt 100 x 1000 K40 Z 10 each	52,57	12	263
6 99 03 036 00 0	4014586283630	Grinding belt 100 x 1000 K60 Z 10 each	46,45	12	263
6 99 03 037 00 0	4014586283647	Grinding belt 100 x 1000 K 80 Z 10 each	43,75	12	263
6 99 03 038 00 0	4014586283654	Grinding belt 100 x 1000 K120 Z 10 each	41,59	12	263
6 99 03 039 00 0	4014586283661	Grinding belt 150 x 2000 K24 R 10 each	218,01	12	262
6 99 03 040 00 0	4014586283678	Grinding belt 150 x 2000 K36 R 10 each	188,07	12	262
6 99 03 041 00 0	4014586283685	Grinding belt 150 x 2000 K36 Z 10 each	146,87	12	263
6 99 03 042 00 0	4014586283692	Grinding belt 150 x 2000 K40 R 10 each	178,62	12	262
6 99 03 043 00 0	4014586283708	Grinding belt 150 x 2000 K40 Z 10 each	139,61	12	263
6 99 03 044 00 0	4014586283715	Grinding belt 150 x 2000 K60 R 10 each	157,88	12	262
6 99 03 045 00 0	4014586283722	Grinding belt 150 x 2000 K60 Z 10 each	123,60	12	263
6 99 03 046 00 0	4014586283739	Grinding belt 150 x 2000 K80 R 10 each	148,53	12	262
6 99 03 047 00 0	4014586283746	Grinding belt 150 x 2000 K80 Z 10 each	116,17	12	263
6 99 03 048 00 0	4014586283753	Grinding belt 150 x 2000 K120 R 10 each	140,99	12	262
6 99 03 049 00 0	4014586283760	Grinding belt 150 x 2000 K120 Z 10 each	110,16	12	263
6 99 03 050 00 0	4014586283777	Grinding belt 150 x 2000 K220 A 10 each	109,03	12	263
6 99 03 051 00 0	4014586283784	Grinding belt 150 x 2000 K320 A 10 each	109,03	12	263
6 99 03 052 00 0	4014586283791	Grinding belt 150 x 2000 K400 A 10 each	109,03	12	263
6 99 03 053 00 0	4014586283807	Grinding belt 150 x 2250 K36 R 10 each	225,56	12	262
6 99 03 054 00 0	4014586283814	Grinding belt 150 x 2250 K36 Z 10 each	176,42	12	263
6 99 03 097 00 0	4014586292915	Grinding belt 100 x 1000 G36 R 10 each	70,76	12	-
6 99 03 098 00 0	4014586292922	Grinding belt 100 x 1000 G60 R 10 each	62,18	12	-
6 99 03 099 00 0	4014586292939	Grinding belt 100 x 1000 G80 R 10 each	58,58	12	-
6 99 03 111 00 0	4014586299235	Grinding belt 150 x 2400 K36 R 10 each	240,66	12	262
6 99 03 112 00 0	4014586299242	Grinding belt 150 x 2400 K36 Z 10 each	188,20	12	263
6 99 03 116 01 0	4014586329888	Fleece belt 150 x 2000 Coarse	320,73	12	263
6 99 03 117 01 0	4014586329895	Fleece belt 75 x 2000 Coarse	160,39	12	263
6 99 03 118 01 0	4014586329901	Fleece belt 150 x 2000 Medium	320,73	12	263
6 99 03 119 01 0	4014586329918	Fleece belt 75 x 2000 Medium	160,39	12	263
6 99 03 120 01 0	4014586329925	Fleece belt 150 x 2000 Very Fine	320,73	12	263
6 99 03 121 01 0	4014586329932	Fleece belt 75 x 2000 Very Fine	160,39	12	263
6 99 03 122 00 0	4014586368054	Abrasive belt	121,25	12	262
6 99 03 122 01 0	4014586332369	Fleece belt set 75	86,51	12	-
6 99 03 126 00 0	4014586379029	Grinding belt Cubitron II 50 x 1000 K36 VE10	149,94	12	251
6 99 03 127 00 0	4014586379036	Grinding belt Cubitron II 50 x 1000 K60 VE10	131,73	12	251
6 99 03 128 00 0	4014586379043	Grinding belt Cubitron II 50 x 1000 K80 VE10	115,67	12	251
6 99 03 130 00 0	4014586379050	Grinding belt 50 x 1000 K36 Z 10 each	56,76	12	251
6 99 03 131 00 0	4014586379067	Grinding belt 50 x 1000 G60 Z 10 each	38,56	12	251
6 99 03 132 00 0	4014586379074	Grinding belt 50 x 1000 G80 Z 10 each	35,34	12	251
6 99 03 133 00 0	4014586379081	Grinding belt 50 x 1000 G120 Z 10 each	28,92	12	251
6 99 03 134 00 0	4014586379098	Grinding belt 50 x 1000 G220 A 10 each	27,85	12	251
6 99 03 135 00 0	4014586379104	Grinding belt 50 x 1000 G320 A 10 each	27,85	12	251
6 99 03 136 00 0	4014586379111	Grinding belt 50 x 1000 G420 A 10 each	27,85	12	251
6 99 03 137 00 0	4014586379128	Grinding belt 50 x 1000 K36 R 10 each	62,12	12	251
6 99 03 138 00 0	4014586379135	Grinding belt 50 x 1000 K60 R 10 each	47,12	12	251
6 99 03 139 00 0	4014586379142	Grinding belt 50 x 1000 K80 R 10 each	42,84	12	251
6 99 03 140 00 0	4014586379159	Grinding belt 50 x 1000 K120 R 10 each	41,77	12	251



Part number	EAN	Description	Price in €	PC	Page
6 99 03 142 00 0	4014586379166	Fleece belt 50 x 1000 Coarse	54,62	12	251
6 99 03 143 00 0	4014586379173	Fleece belt 50 x 1000 Medium	52,48	12	251
6 99 03 144 00 0	4014586379180	Fleece belt 50 x 1000 Very Fine	49,27	12	251
6 99 03 145 00 0	4014586385891	Cubitron II 75 x 2000 36+ 10 p grinding belt	236,25	12	262
6 99 03 146 00 0	4014586385907	Cubitron II 75 x 2000 60+ 10 p grinding belt	200,55	12	262
6 99 03 147 00 0	4014586385914	Cubitron II 75 x 2000 80+ 10 p grinding belt	189,00	12	262
6 99 03 148 00 0	4014586385921	Cubitron II 150 x 2000 36+ 10 p grinding belt	435,75	12	262
6 99 03 149 00 0	4014586385938	Cubitron II 150 x 2000 60+ 10 p grinding belt	363,30	12	262
6 99 03 150 00 0	4014586385945	Cubitron II 150 x 2000 80+ 10 p grinding belt	341,25	12	262
6 99 03 151 00 0	4014586385952	Cubitron II 75 x 2250 36+ 10 p grinding belt	271,95	12	262
6 99 03 152 00 0	4014586385969	Cubitron II 75 x 2250 60+ 10 p grinding belt	232,05	12	262
6 99 03 153 00 0	4014586385976	Cubitron II 75 x 2250 80+ 10 p grinding belt	220,50	12	262
6 99 03 154 00 0	4014586385983	Cubitron II 150 x 2250 36+ 10 p grinding belt	502,95	12	262
6 99 03 155 00 0	4014586385990	Cubitron II 150 x 2250 60+ 10 p grinding belt	421,05	12	262
6 99 03 156 00 0	4014586386003	Cubitron II 150 x 2250 80+ 10 p grinding belt	395,85	12	262
6 99 03 157 00 0	4014586405063	Grinding belt Cubitron II 50 x 1150 K36 VE10	172,20	12	251
6 99 03 158 00 0	4014586405070	Grinding belt 50 x 1150 K36 R 10 each	71,40	12	251
6 99 03 159 00 0	4014586405087	Grinding belt 50 x 1150 K36 Z 10 each	67,20	12	251
9 01 02 009 01 0	4014586869537	Accu-Tec angled head 1/4", hexagon socket	962,85	05	-
9 01 02 010 01 0	4014586869544	Accu-Tec angled head 1/4", square head	962,85	05	-
9 01 02 011 01 0	4014586869551	Accu-Tec angled head 3/8", square head	962,85	05	-
9 01 02 012 01 0	4014586876894	Accu-Tec angled head 1/4", hexagon socket QuickIN	427,35	05	35
9 01 02 013 01 0	4014586876900	Accu-Tec angled head 3/8", square head	427,35	05	35
9 01 02 014 01 0	4014586882703	Angled head Basic	427,35	05	35
9 01 02 015 02 0	4014586882802	Angled head	534,45	05	35
9 01 02 016 02 0	4014586882826	Angled head	534,45	05	35
9 01 04 009 01 0	4014586871622	M55 X magazine	198,45	01	19
9 01 04 010 01 0	4014586871639	M55 X magazine extension with belt guide	199,21	02	19
9 01 05 002 01 8	4014586833682	Safety slipping clutch	976,75	02	71
9 01 06 001 02 0	4014586886930	Straight output	156,45	05	35
9 01 06 002 02 0	4014586886626	Straight output	156,45	05	35
9 06 04 008 01 3	4014586849805	Suction hood	228,12	02	99
9 06 04 009 01 7	4014586849829	Suction hood	235,62	02	99
9 06 06 002 00 9	4014586834467	Saw blade guide	265,61	02	142
9 07 01 002 01 0	4014586878522	Prism vice	103,95	02	75
9 07 02 003 00 8	4014586834511	Clamping fixture	269,85	02	142
9 07 02 004 00 6	4014586834528	Clamping fixture	334,95	02	142
9 07 02 005 00 0	4014586839783	FEIN clamp and feed device	1.920,45	02	142
9 12 01 002 00 4	4014586842868	Cooling lubrication	2.206,05	08	-
9 26 01 022 01 3	4014586846965	Vacuum pump assy	499,09	02	157
9 26 01 023 02 3	4014586847283	Compressor	1.230,60	08	-
9 26 02 030 01 4	4014586836805	Traction cable	16,07	04	245
9 26 02 054 01 6	4014586841342	Suction plate	465,89	02	157
9 26 02 055 01 0	4014586841335	Pipe drilling device	253,83	02	157
9 26 02 057 01 7	4014586843322	Vacuum plate assy	484,09	02	157
9 26 02 063 02 3	4014586844503	Dust Extraction	52,48	04	-
9 26 02 066 01 2	4014586846989	Tapping Unit	1.167,60	01	172
9 26 02 071 01 9	4014586851389	Profile set 160	350,70	01	132
9 26 02 072 01 2	4014586852478	Tapping Unit	865,20	01	172
9 26 02 074 01 4	4014586855080	Dust extraction device FSC	50,34	04	238
9 26 02 075 01 8	4014586855097	Device for dust extract	64,26	04	238
9 26 02 079 01 0	4014586857152	Tapping quick-change chuck	251,69	02	172
9 26 02 081 01 0	4014586860183	Dust Extraction	50,34	04	-
9 26 02 082 01 0	4014586861920	Tapping quick-change chuck	355,57	02	176
9 26 02 083 01 0	4014586860152	Table-top and drill jigs support	45,70	04	227
9 26 02 084 01 0	4014586863542	Device for dust extract	65,33	04	237
9 26 02 085 01 0	4014586867977	Vacuum plate	484,09	02	177
9 26 02 086 01 0	4014586868943	Dust Extraction	50,34	04	-
9 26 02 088 01 0	4014586878492	Dust extraction set	40,70	04	-
9 26 02 089 01 0	4014586878508	Tappingfast-rel.chuck	255,97	02	172
9 26 02 091 00 0	4014586882932	Dust extraction set FMM 350 Q / QSL	39,98	04	227
9 26 02 092 00 0	4014586882949	Dust extraction set FMT / FMM 250	49,13	04	227
9 26 02 095 00 0	4014586885551	Dust extraction set	49,13	04	-
9 26 04 079 02 1	4014586853574	Battery ass.	199,50	02	34
9 26 04 082 02 5	4014586855127	NiMH battery 9.6 V	147,00	02	34
9 26 04 084 02 7	4014586855141	NiMH battery 12 V / 2000 mAh	157,50	02	34
9 26 04 096 01 0	4014586863986	Quick charger ALG 30	142,80	02	14
9 26 04 103 01 0	4014586862651	Charging adapter	19,95	02	34
9 26 04 111 01 0	4014586869308	Multi-charger ALS 40	1.573,95	02	34
9 26 04 129 01 0	4014586867687	Quick charger ALG 50	40,95	02	14
9 26 04 160 00 0	4014586871561	Contact holder	58,80	02	-
9 26 04 160 02 0	4014586872797	Battery Li-Ion 14,4V	91,35	02	-
9 26 04 160 03 0	4014586877228	Battery Li-Ion 14,4V	1.182,30	02	-
9 26 04 161 02 0	4014586872803	Li-Ion battery, 18V	103,95	02	-
9 26 04 161 03 0	4014586880334	Li-Ion battery, 18V	1.073,10	02	-
9 26 04 163 02 0	4014586872681	Programming adapter	387,45	02	35

Part number	EAN	Description	Price in €	PC	Page
9 26 04 164 02 0	4014586872810	Battery Li-Ion 14,4V	126,00	02	-
9 26 04 164 03 0	4014586877235	Battery Li-Ion 14,4V	1.629,60	02	-
9 26 04 165 02 0	4014586872827	Li-Ion battery, 18V	155,40	02	59
9 26 04 166 02 0	4014586874449	Li-ion 10.8 - 14.4 V, 2 Ah, with charge monitoring display	126,00	02	-
9 26 04 168 02 0	4014586881157	Li-Ion battery, 12V	30,45	02	14
9 26 04 170 02 0	4014586882727	Battery Li-Ion 14,4V	72,45	02	34
9 26 04 170 03 0	4014586885148	Battery Li-Ion 14,4V	999,60	02	34
9 26 04 171 02 0	4014586882734	Li-Ion battery, 18V	72,45	02	14
9 26 04 171 03 0	4014586885155	Li-Ion battery, 18V	799,05	02	34
9 26 04 172 02 0	4014586882741	Battery Li-Ion 14,4V	103,95	02	34
9 26 04 172 03 0	4014586885162	Battery Li-Ion 14,4V	1.434,30	02	34
9 26 04 173 02 0	4014586882758	Li-Ion battery, 18V	103,95	02	14
9 26 04 173 03 0	4014586885179	Li-Ion battery, 18V	1.146,60	02	34
9 26 04 200 02 0	4014586882819	Cordless ALED 12-18 V LED lamp	52,50	02	14
9 26 04 250 01 0	4014586885827	Battery starter set 12 V / 2,5 Ah	101,85	02	14
9 26 04 300 01 0	4014586881706	Battery starter set 18 V / 2.0 Ah	180,60	02	-
9 26 04 300 02 0	4014586881720	Battery starter set 18 V / 4.0 Ah	223,65	02	-
9 26 04 300 03 0	4014586885841	Battery starter set 18 V / 5.0 Ah	248,85	02	14
9 26 04 300 04 0	4014586885858	Battery starter set 18 V / 2,5 Ah	185,85	02	14



Part number	Sound pressure level LpA (dB)	Uncertainty of measured value KpA (dB)	Sound power level LWA (dB)	Uncertainty of measured value KWA (dB)	Sound peak value LpCpeak (dB)	Uncertainty of measured value KpCpeak (dB)	Vibration value 1 ahv 3-way (m/s <sup>2</sup> )	Vibration value 2 ahv 3-way (m/s <sup>2</sup> )	Uncertainty of measured value Ka (m/s <sup>2</sup> )
7 205 43	82	3	93	3	96	3	4	1,5	
7 205 44	82	3	93	3	96	3	3	1,5	
7 205 45	82	3	93	3	96	3	3	1,5	
7 201 39	77	3	88	3		3	1,3	1,5	
7 201 63	77	3	88	3		3	1,4	1,5	
7 201 62	77	3	88	3		3	1,2	1,5	
7 205 35	77	3	88	3		3	1,2	1,5	
7 201 06	86	3	97	3	102	3	ah,D 2,0	1,5	
7 201 14	86	3	97	3	102	3	ah,D 2,0	1,5	
7 205 20	76	3	87	3		3	< 2,5	1,5	
7 205 03	81	3	92	3	98	3	ah,D 0,4	1,5	
7 202 45	78	3	89	3		3	1,6	1,5	
7 205 37	75	3	86	3		3	1,2	1,5	
7 205 40	84	3	95	3	99	3	1,5	1,5	
7 202 03	86	3	97	3	102	3	ah,D 2,2	1,5	
7 202 10	86	3	97	3	102	3	ah,D 2,2	1,5	
7 202 26	81	3	92	3	97	3	ah,D 0,6	1,5	
7 202 27	81	3	92	3	97	3	ah,D 0,6	1,5	
7 202 09	86	3	97	3	102	3	ah,D 1,6	1,5	
7 202 06	88	3	99	3	103	3	ah,D 1,3	1,5	
7 205 01	81	3	92	3	99	3	ah,D 0,9	1,5	
7 205 34	77	3	88	3	93	3	1,1	1,5	
7 203 04	86	3	97	3	102	3	ah,D 1,5	1,5	
7 204 30	98	3	109	3	99	3	1,5	1,5	15
7 209 37	79	3	90	3	93	3	0,6	1,5	
7 209 16	87	3	98	3	101	3	1	1,5	
7 271 01	81	3	92	3	96	3	ah,D 3,5	1,5	ah,D 5,0
7 272 02	87	3	98	3	103	3		1,5	
7 272 03	87	3	98	3	99	3		1,5	
7 272 04	92	3	103	3	106	3		1,5	
7 270 27	84	3	95	3		3	0,5	1,5	
7 270 33	84	3	95	3		3		1,5	
7 270 31	82	3	93	3		3		1,5	
7 270 29	83	3	94	3		3		1,5	
7 270 28	83	3	94	3		3		1,5	
7 270 34	84	3	95	3	101	3		1,5	
7 270 32	84	3	95	3	101	3		1,5	
7 113 01	60	3	71	3	74	3	0,9	1,5	
7 113 02	71	3	82	3	84	3	1,2	1,5	
7 113 03	71	3	82	3	84	3	1,3	1,5	
7 113 06	71	3	82	3	84	3	1,6	1,5	
7 104 03	86	3	97	3	104	3	14	1,5	
7 104 04	90	3	101	3	105	3	12	1,5	
7 210 71	78	3	89	3	92	3	1,1	1,5	
7 210 94	78	3	89	3	92	3	1	1,5	
7 113 10	71	3	82	3	88	3	0,7	1,5	
7 113 11	73	3	84	3	92	3	1	1,5	
7 213 09	77	3	88	3	93	3	0,5	1,5	
7 213 04	82	3	93	3	96	3	1	1,5	
7 213 13	81	3	92	3	98	3	0,8	1,5	
7 213 14	81	3	92	3	98	3	0,8	1,5	
7 213 06	81	3	92	3	98	3	0,8	1,5	
7 213 08	81	3	92	3	98	3	0,8	1,5	
7 213 15	81	3	92	3	98	3	0,8	1,5	
7 210 98	86	3	97	3		3	<2,5	1,5	
7 215 29	93	3	104	3		3	6,5	1,5	
7 215 30	93	3	104	3		3	6,5	1,5	
7 215 28	96	3	107	3		3	8,8	1,5	
7 215 12	93	3	104	3		3	5,4	1,5	
7 215 13	93	3	104	3		3	5,4	1,5	
7 215 23	93	3	104	3		3	5,4	1,5	
7 215 07	95	3	106	3		3	10	1,5	
7 215 08	95	3	106	3		3	10	1,5	
7 215 21	95	3	106	3		3	10	1,5	
7 215 25	95	3	106	3		3	10	1,5	
7 215 26	95	3	106	3		3	10	1,5	
7 112 07	69	3	80	3		3	0,2	1,5	
7 112 06	62	3	73	3		3	0,2	1,5	
7 112 05	60	3	71	3		3	0,2	1,5	
7 112 04	67	3	78	3		3	0,3	1,5	



**Vibration and noise emission values**

Part number	Sound pressure level LpA (dB)	Uncertainty of measured value KpA (dB)	Sound power level LWA (dB)	Uncertainty of measured value KWA (dB)	Sound peak value LpCpeak (dB)	Uncertainty of measured value KpCpeak (dB)	Vibration value 1 ahv 3-way (m/s <sup>2</sup> )	Vibration value 2 ahv 3-way (m/s <sup>2</sup> )	Uncertainty of measured value Ka (m/s <sup>2</sup> )
7 112 03	65	3	76	3		3	0,4	1,5	
7 112 36	69	3	80	3		3	0,4	1,5	
7 112 40	62	3	73	3	79,7	3	0,4	1,5	
7 112 41	62	3	73	3	79,7	3	0,4	1,5	
7 112 42	60	3	71	3	75,6	3	0,4	1,5	
7 112 43	60	3	71	3	75,6	3	0,4	1,5	
7 112 44	60	3	71	3	75,6	3	0,4	1,5	
7 112 02	69	3	80	3		3	0,5	1,5	
7 112 01	68	3	79	3		3	0,6	1,5	
7 113 05	70	3	81	3		3	<2,5	1,5	
7 110 94	70	3	81	3		3	<2,5	1,5	
7 112 45	64,6	3	75,6	3	81,1	3	0,6	1,5	
7 221 61	84	3	95	3	99	3	ah,AG 5,0	1,5	ah,DS 2,5
7 221 62	84	3	95	3	99	3	ah,AG 4,5	1,5	ah,DS 2,5
7 221 41	87	3	98	3	99	3	ah,AG 5,0	1,5	ah,DS 2,5
7 221 44	84	3	95	3	99	3	ah,AG 4,5	1,5	ah,DS 2,5
7 221 42	84	3	95	3	101	3	ah,AG 4,5	1,5	ah,DS 2,5
7 221 43	84	3	95	3	101	3	ah,AG 4,5	1,5	ah,DS 2,5
7 221 40	87	3	98	3	99	3	ah,AG 5,0	1,5	ah,DS 2,5
7 221 46	85	3	96	3		3	ah,AG 4,5	1,5	
7 221 47	85	3	96	3		3	ah,AG 5,0	1,5	
7 221 31	87	3	98	3		3	ah,AG 3,8	1,5	
7 221 07	87	3	98	3	103	3	ah,AG 6,0	1,5	ah,DS 2,5
7 221 08	87	3	98	3	103	3	ah,AG 6,0	1,5	ah,DS 2,5
7 221 05	87	3	98	3	103	3	ah,AG 6,0	1,5	ah,DS 2,5
7 221 06	87	3	98	3	103	3	ah,AG 6,0	1,5	ah,DS 2,5
7 221 26	87	3	98	3	103	3	ah,AG 6,0	1,5	ah,DS 2,5
7 221 27	87	3	98	3	103	3	ah,AG 6,0	1,5	ah,DS 2,5
7 221 01	87	3	98	3	103	3	ah,AG 6,0	1,5	ah,DS 2,5
7 221 02	87	3	98	3	103	3	ah,AG 6,0	1,5	ah,DS 2,5
7 223 02	81	3	92	3	95	3	ah,SG 1,5	1,5	
7 223 12	84	3	95	3	98	3	ah,SG 1,6	1,5	
7 223 03	81	3	92	3	95	3	ah,SG 1,5	1,5	
7 223 14	87	3	98	3	101	3	ah,SG ØD=50 mm 17,0	1,5	ah,SG ØD=12 mm 2,3
7 223 14	86	3	97	3	101	3	ah,SG ØD=50 mm 27,0	1,5	ah,SG ØD=12 mm 3,9
7 223 13	86	3	97	3	100	3	ah,SG ØD=50 mm 2,9	1,5	ah,SG ØD=12 mm 1,5
7 224 04	87	3	98	3	103	3	ah,SG 2,4	1,5	
7 224 05	93	3	104	3	106	3	ah,SG 2,0	1,5	
7 220 78	87	3	98	3	105	3	12	1,5	
7 220 92	87	3	98	3		3	4	1,5	
7 221 63	84	3	95	3	100	3	ah,P 3,5	1,5	ah,DS 2,5
7 221 48	84	3	95	3	100	3	ah,P 2,5	1,5	ah,DS 2,5
7 221 49	84	3	95	3	100	3	ah,P 3,5	1,5	ah,DS 2,5
7 221 50	84	3	95	3	100	3	ah,P 2,5	1,5	
7 221 66	84	3	95	3	98	3	4,5	1,5	
7 221 13	86	3	97	3	102	3	2,4	1,5	
7 228 05	84	3	95	3	99	3	2	1,5	
7 221 67	85	3	96	3	101	3	ah,P/T=3 2,5	1,5	ah,P/T=6 5,0
7 129 09	76	3	87	3	91	3		1,5	
7 536 02	81	3	92	3		3		1,5	
7 229 36	74	3	85	3	96	3		1,5	
7 229 37	74	3	85	3	96	3		1,5	
7 136 01	78	3	89	3	91	3		1,5	
7 136 02	78	3	89	3	91	3		1,5	
7 236 36	79	3	90	3	93	3		1,5	
7 236 31	79	3	90	3	93	3		1,5	
7 230 27	82	3	93	3		3	1,5	1,5	
7 230 28	82	3	93	3		3	1,5	1,5	
7 230 22	81	3	92	3		3	1,5	1,5	
7 230 29	80	3	91	3		3	4,7	1,5	
7 230 26	80	3	91	3		3	15,6	1,5	
7 230 23	86	3	97	3	103	3	12,1	1,5	
7 230 24	87	3	98	3	103,1	3	22,6	1,5	
7 232 35	76	3	87	3	92	3	11,3	1,5	
7 232 32	76	3	87	3	92	3	9,3	1,5	
7 232 36	76	3	87	3	92	3	6,4	1,5	
7 232 37	77	3	88	3	93	3	9,19	1,5	
7 232 29	78	3	89	3	93	3	4,4	1,5	
7 232 30	85	3	96	3	100	3	8,9	1,5	
7 232 31	85	3	96	3	100	3	10	1,5	



Part number	Sound pressure level LpA (dB)	Uncertainty of measured value KpA (dB)	Sound power level LWA (dB)	Uncertainty of measured value KWA (dB)	Sound peak value LpCpeak (dB)	Uncertainty of measured value KpCpeak (dB)	Vibration value 1 ahv 3-way (m/s <sup>2</sup> )	Vibration value 2 ahv 3-way (m/s <sup>2</sup> )	Uncertainty of measured value Ka (m/s <sup>2</sup> )
7 234 17	79	3	90	3	94	3	7,8	1,5	
7 234 15	79	3	90	3	94	3	7,8	1,5	
7 234 06	83	3	94	3	97	3	16	1,5	13
7 234 22	89	3	100	3	102	3	7	1,5	
7 234 23	89	3	100	3	102	3	7	1,5	
7 534 08	81	3	92	3	102	3	ah,D 7.1	1,5	
7 238 14	86,5	3	97,5	3	102	3	3,5	1,5	
7 824 41	84	3	95	3	97	3	Ø 80 mm=11,8 Ø 50 mm=6,3	1,5	
7 824 39	84	3	95	3	103	3	Ø 125 mm=7,5 Ø 100 mm=3,3	1,5	
7 824 40	84	3	95	3	97	3	Ø 125 mm=2,0	1,5	
7 824 37	83	3	94	3	101	3	2	1,5	
7 824 36	79	3	90	3	98	3	2	1,5	
7 824 38	83	3	94	3	101	3	3,8	1,5	
7 823 03	71	3	82	3	85	3	3,7	1,5	
7 823 14	77	3	88	3	88	3	3,7	1,5	
7 823 15	71	3	82	3	84	3	2	1,5	
7 823 19	79	3	90	3	92	3	5	1,5	
7 823 21	79	3	90	3		3	1	1,5	
7 823 20	77	3	88	3	92	3	5,5	1,5	
7 820 51	77	3	88	3	93	3	3,5	1,5	
7 820 81	76	3	87	3	91	3	0,5	1,5	
7 820 84	81	3	92	3	98	3	2,1	1,5	
7 820 85	81	3	92	3	95	3	4,5	1,5	
7 820 78	79	3	90	3	95	3	0,6	1,5	
7 820 79	81	3	92	3	100	3	4,3	1,5	
7 820 71	81	3	92	3	95	3	4,3	1,5	
7 820 72	81	3	92	3	95	3	4,6	1,5	
7 820 83	83	3	94	3	97	3	3,6	1,5	
7 820 62	83	3	94	3	100	3	3,9	1,5	
7 820 64	84	3	95	3	100	3	3,9	1,5	
7 820 74	85	3	96	3	100	3	3,8	1,5	
7 820 76	85	3	96	3	100	3	4,7	1,5	
7 105 01	75	3	86	3	91	3	2,7	1,5	
7 105 02	75	3	86	3	89	3	1,8	1,5	
7 105 03	75	3	86	3	91	3	2,5	1,5	
7 205 46	82	3	93	3	96	3	3	1,5	
7 272 01	83	3	94	3	98	3		1,5	
7 113 14	71	3	82	3	86	3	1,5	1,5	
7 113 14	71	3	82	3	86	3	1,5	1,5	
7 113 15	71	3	82	3	86	3	1,5	1,5	
7 113 15	71	3	82	3	86	3	1,5	1,5	
7 113 16	74	3	85	3	87	3	1,5	1,5	
7 113 16	74	3	85	3	87	3	1,5	1,5	
7 113 17	74	3	85	3	87	3	1,5	1,5	
7 221 55	85	3	96	3	99	3	ah,AG 4,5	1,5	ah,DS 2,0
7 221 56	85	3	96	3	99	3	ah,AG 4,5	1,5	ah,DS 2,5
7 221 57	85	3	96	3	101	3	ah,AG 4,0	1,5	ah,DS 2,5
7 221 58	85	3	96	3	101	3	ah,AG 4,0	1,5	ah,DS 2,5
7 221 54	85	3	96	3	99	3	ah,AG 4,5	1,5	ah,DS 2,5
7 236 42	79	3	90	3	93	3		1,5	
7 820 86	74	3	85	3	90	3	ah,AG 2,8	1,5	ah,DS 1,0
7 536 03	82	3	93	3		3		1,5	
7 132 03	74	3	85	3	86	3	4,7	1,5	
7 132 02	74	3	85	3	86	3	4,7	1,5	
7 132 01	74	3	85	3	86	3	6,5	1,5	
7 144 01	67	3	78	3	83	3		1,5	
7 232 38	82	3	93	3	93	3	8,8	1,5	
7 232 41	82	3	93	3	93	3	9,5	1,5	
7 232 42	82	3	93	3	93	3	6,8	1,5	
7 232 39	82	3	93	3	93	3	8,8	1,5	
7 232 40	80	3	91	3	91	3	7,3	1,5	
7 520 15	80	3	91	3		3	4,5	1,5	
7 520 16	80	3	91	3		3	4,5	1,5	
9 20 22	73	3	84	3		3		1,5	
9 20 23	73	3	84	3		3		1,5	
7 270 41	82,4	3	93,4	3	97	3	< 2,5	1,5	
7 270 40	82,4	3	93,4	3	97	3	< 2,5	1,5	
7 270 42	82,4	3	93,4	3	97	3	< 2,5	1,5	

**Vibration and noise emission values**

Part number	Sound pressure level LpA (dB)	Uncertainty of measured value KpA (dB)	Sound power level LWA (dB)	Uncertainty of measured value KWA (dB)	Sound peak value LpCpeak (dB)	Uncertainty of measured value KpCpeak (dB)	Vibration value 1 ahv 3-way (m/s <sup>2</sup> )	Vibration value 2 ahv 3-way (m/s <sup>2</sup> )	Uncertainty of measured value Ka (m/s <sup>2</sup> )
7 270 43	82,4	3	93,4	3	97	3	< 2,5	1,5	
7 113 18	80	3	91	3	91	3	0,5	1,5	1,5
7 113 18	80	3	91	3	91	3	0,5	1,5	1,5
7 104 05	85	3	96	3	104	3	0,5	1,5	10,5
7 104 05	85	3	96	3	104	3	0,5	1,5	10,5
7 113 19	76	3	87	3	90	3	0,6	1,5	1,8
7 113 19	76	3	87	3	90	3	0,6	1,5	1,8
7 104 06	87	3	98	3	106	3	0,6	1,5	12,1
7 104 06	87	3	98	3	106	3	0,6	1,5	12,1
7 115 01	86	3	97	3	109	3	6	1,5	
7 115 01	86	3	97	3	109	3	6	1,5	
7 115 02	86	3	97	3	109	3	6	1,5	
7 115 02	86	3	97	3	109	3	6	1,5	
7 116 01	74	3	85	3	87	3	1,5	1,5	
7 116 02	74	3	85	3	87	3	1,5	1,5	
7 116 06	74	3	85	3	87	3	1,5	1,5	
7 116 05	74	3	85	3	87	3	1,5	1,5	
7 116 03	73	3	84	3	86	3	1,5	1,5	
7 116 04	73	3	84	3	86	3	1,5	1,5	
7 116 04	73	3	84	3	86	3	1,5	1,5	
7 116 08	73	3	84	3	86	3	1,5	1,5	
7130 02	74,6	3	85,6	3	87,9	3	3,3	1,5	
7 130 01	74,8	3	85,8	3	87,9	3	10,1	1,5	
7 230 34	82,5	3	93,5	3	94,9	3	4,1	1,5	
7 230 35	81,7	3	92,7	3	93,8	3	4,8	1,5	
7 230 31	81,1	3	92,1	3	93,3	3	5,7	1,5	
7 230 32	81,1	3	92,1	3	93,3	3	5,7	1,5	
7 230 33	76,2	3	87,2	3	91	3	10,8	1,5	
7 221 73	90	3	101	3	105	3	ah,AG 5,0	1,5	ah,DS 1,8
7 221 74	90	3	101	3	105	3	ah,AG 5,0	1,5	ah,DS 1,8
7 221 77	90	3	101	3	105	3	ah,AG 6,0	1,5	ah,DS 1,8
7 221 75	89	3	100	3	104	3	ah,AG 5,0	1,5	ah,DS 2,0
7 221 76	89	3	100	3	104	3	ah,AG 5,0	1,5	ah,DS 2,0
7 221 78	90	3	101	3	105	3	ah,AG 5,0	1,5	ah,DS 3,5
7 221 79	90	3	101	3	105	3	ah,AG 5,0	1,5	ah,DS 3,5
7 221 80	90	3	101	3	105	3	ah,AG 5,0	1,5	ah,DS 3,5
7 221 81	90	3	101	3	105	3	ah,AG 5,0	1,5	ah,DS 3,5
7 221 82	90	3	101	3	105	3	ah,AG 5,0	1,5	ah,DS 3,5
7 221 83	90	3	101	3	105	3	ah,AG 5,0	1,5	ah,DS 3,5
7 221 84	90	3	101	3	105	3	ah,AG 5,0	1,5	ah,DS 3,5
7 236 38	79	3	90	3	93	3		1,5	
7 112 08	69	3	80	3		3	0,4	1,5	
7 112 09	69	3	80	3		3	0,4	1,5	
7 112 00	69	3	80	3		3	0,4	1,5	
7 205 47	81,1	3	92,1	3	95,2	3	ah,D 2.4	1,5	
7 205 49	82,1	3	93,1	3	95,6	3	ah,D 1.9	1,5	
7 112 50	62	3	73	3	80	3	0,4	1,5	
7 112 51	60	3	71	3	76	3	0,4	1,5	
7 112 52	65	3	76	3	81	3	0,6	1,5	
7 112 53	70,8	3	81,8	3	86,1	3	0,5	1,5	
7 112 54	63,9	3	74,9	3	81	3	0,2	1,5	
7 112 55	66,3	3	77,3	3	81	3	0,3	1,5	
7 112 56	66,8	3	77,8	3	81	3	0,3	1,5	
7 229 43	74	3	85	3	96	3		1,5	
7 229 44	74	3	85	3	96	3		1,5	
7 229 42	72	3	83	3	84	3		1,5	
7 271 04	81	3	92	3	96	3	ah,D 3,5	1,5	ah,D 5,5
7 271 03	81	3	92	3	96	3	ah,D 3,5	1,5	ah,D 5,5
9 20 27	68	3	81	3		3	<2,5	1,5	
9 20 28	68	3	81	3		3	<2,5	1,5	
7 205 51	82	3	93	3	96	3	3	1,5	
7 105 04	75	3	86	3	89	3	1,8	1,5	
7 223 16	84	3	95	3	97	3	ah,SG (Ø 25 mm) 4,7	1,5	
7 223 17	84	3	95	3	97	3	ah,SG (Ø 25 mm) 4,7	1,5	ah,SG (Ø 50 mm) 7,9
7 223 18	84	3	95	3	97	3	ah,SG (Ø 25 mm) 5,3	1,5	
7 223 19	84	3	95	3	97	3	ah,SG (Ø 25 mm) 5,3	1,5	ah,SG (Ø 50 mm) 11,4
7 223 24	83	3	94	3	95	3	ah,SG (Ø 25 mm) 4,8	1,5	
7 223 25	83	3	94	3	95	3	ah,SG (Ø 25 mm) 1,0	1,5	ah,P 1,5
7 223 20	84	3	95	3	97	3	ah,SG (Ø 25 mm) 1,9	1,5	ah,SG (Ø 50 mm) 2,9
7 223 21	85	3	96	3	98	3	ah,SG (Ø 25 mm) 9,7	1,5	





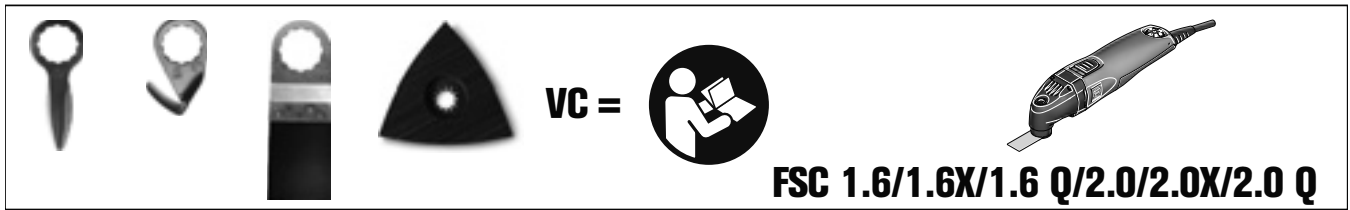

Part number	Sound pressure level LpA (dB)	Uncertainty of measured value KpA (dB)	Sound power level LWA (dB)	Uncertainty of measured value KWA (dB)	Sound peak value LpCpeak (dB)	Uncertainty of measured value KpCpeak (dB)	Vibration value 1 ahv 3-way (m/s <sup>2</sup> )	Vibration value 2 ahv 3-way (m/s <sup>2</sup> )	Uncertainty of measured value Ka (m/s <sup>2</sup> )
7 223 22	85	3	96	3	98	3	ah,SG (Ø 25 mm) 9,7	1,5	
7 223 23	85	3	96	3	98	3	ah,SG (Ø 25 mm) 1,5	1,5	ah,SG (Ø 50 mm) 4,5
7 221 86	90	3	101	3	105	3	ah,AG 7,9	1,5	ah,DS 1,5
7 221 87	90	3	101	3	105	3	ah,AG 7,9	1,5	ah,DS 1,5
7 221 88	90	3	101	3	105	3	ah,AG 7,3	1,5	ah,DS 1,5
7 221 89	90	3	101	3	105	3	ah,AG 7,3	1,5	ah,DS 1,5
7 221 90	90	3	101	3	105	3	ah,AG 5,9	1,5	ah,DS 2,1
7 221 91	90	3	101	3	105	3	ah,AG 5,9	1,5	ah,DS 2,1
7 221 92	90	3	101	3	105	3	ah,AG 5,0	1,5	ah,DS 1,6
7 221 93	90	3	101	3	105	3	ah,AG 5,0	1,5	ah,DS 1,6
7 221 94	90	3	101	3	105	3	ah,AG 3,4	1,5	ah,DS 1,6
7 221 95	90	3	101	3	105	3	ah,AG 3,4	1,5	ah,DS 1,6
7 115 03	93,8	3	104,8	3	112	3	14,5	1,5	
7 116 10	74	3	75,5	3	86,5	3	1,0	1,5	
7 113 21	65,9	3	76,9	3	78,9	3	ah 0.4	1,5	
7 113 20	65,6	3	76,6	3	78,4	3	1	1,5	
7 129 15	70	3	81	3	83	3		1,5	
7 129 12	74	3	85	3	87	3		1,5	
7 222 07	90	3	101	3	105	3	ah,AG 5,0	1,5	ah,DS 3,5
7 222 08	90	3	101	3	105	3	ah,AG 5,0	1,5	ah,DS 3,5
7 222 09	90	3	101	3	105	3	ah,AG 5,0	1,5	ah,DS 3,5
7 222 10	90	3	101	3	105	3	ah,AG 5,0	1,5	ah,DS 3,5
7 222 11	90	3	101	3	105	3	ah,AG 5,0	1,5	ah,DS 3,5
7 222 12	90	3	101	3	105	3	ah,AG 5,0	1,5	ah,DS 3,5
7 222 13	90	3	101	3	105	3	ah,AG 4,1	1,5	ah,DS 2,2
7 222 18	90	3	101	3	105	3	ah,AG 5,9	1,5	ah,DS 2,1
7 222 19	90	3	101	3	105	3	ah,AG 5,9	1,5	ah,DS 2,1
7 222 20	90	3	101	3	105	3	ah,AG 5,0	1,5	ah,DS 1,6
7 222 21	90	3	101	3	105	3	ah,AG 5,0	1,5	ah,DS 1,6
7 222 22	90	3	101	3	105	3	ah,AG 3,4	1,5	ah,DS 1,6
7 222 23	90	3	101	3	105	3	ah,AG 3,4	1,5	ah,DS 1,6
7 129 27	83	3	94	3	97	3		1,5	
7 129 25	70	3	81	3	83	3		1,5	
7 129 26	70	3	81	3	83	3		1,5	
7 109 01	75	3	86	3	91	3	2,7	1,5	
7 209 38	82	3	93	3	96	3	<1.5	1,5	
7 129 22	74	3	85	3	87	3		1,5	
7 229 52	72	3	83	3	84	3		1,5	
7 229 54	74	3	85	3	96	3		1,5	
7 229 53	74	3	85	3	96	3		1,5	



	VC		VC		VC
6 35 02 102 ...	2	6 39 03 083 ...	2	6 39 03 161 ...	3
6 35 02 103 ...	2	6 39 03 087 ...	2	6 39 03 162 ...	3
6 35 02 115 ...	2	6 39 03 095 ...	2	6 39 03 163 ...	2
6 35 02 116 ...	2	6 39 03 097 ...	3	6 39 03 164 ...	2
6 35 02 119 ...	3	6 39 03 099 ...	4	6 39 03 166 ...	3
6 35 02 120 ...	4	6 39 03 101 ...	3	6 39 03 168 ...	4
6 35 02 121 ...	4	6 39 03 103 ...	2	6 39 03 169 ...	4
6 35 02 122 ...	4	6 39 03 104 ...	2	6 39 03 170 ...	4
6 35 02 123 ...	4	6 39 03 105 ...	3	6 39 03 171 ...	4
6 35 02 124 ...	4	6 39 03 107 ...	3	6 39 03 172 ...	2
6 35 02 135 ...	3	6 39 03 108 ...	2	6 39 03 173 ...	2
6 35 02 136 ...	4	6 39 03 109 ...	2	6 39 03 174 ...	3
6 35 02 137 ...	2	6 39 03 110 ...	2	6 39 03 176 ...	3
6 35 02 138 ...	3	6 39 03 111 ...	4	6 39 03 179 ...	4
6 35 02 145 ...	2	6 39 03 113 ...	3	6 39 03 181 ...	3
6 35 02 147 ...	3	6 39 03 114 ...	3	6 39 03 182 ...	5
6 35 02 148 ...	3	6 39 03 115 ...	2	6 39 03 183 ...	2
6 35 02 158 ...	2	6 39 03 116 ...	4	6 39 03 184 ...	2
6 35 02 162 ...	4	6 39 03 117 ...	4	6 39 03 185 ...	2
6 35 02 163 ...	4	6 39 03 118 ...	2	6 39 03 186 ...	2
6 35 02 164 ...	3	6 39 03 120 ...	2	6 39 03 189 ...	3
6 35 02 165 ...	4	6 39 03 121 ...	2	6 39 03 190 ...	4
6 35 02 167 ...	1	6 39 03 122 ...	2	6 39 03 191 ...	3
6 35 02 168 ...	1	6 39 03 123 ...	4	6 39 03 194 ...	4
6 35 02 172 ...	1	6 39 03 124 ...	2	6 39 03 195 ...	4
6 35 02 173 ...	1	6 39 03 125 ...	4	6 39 03 196 ...	3
6 35 02 185 ...	3	6 39 03 127 ...	2	6 39 03 198 ...	4
6 35 02 186 ...	2	6 39 03 128 ...	3	6 39 03 206 ...	3
6 37 06 018 ...	3	6 39 03 129 ...	3	6 39 03 207 ...	3
6 37 31 001 ...	1	6 39 03 131 ...	3	6 39 03 208 ...	3
6 37 31 002 ...	1	6 39 03 132 ...	3	6 39 03 209 ...	3
6 37 31 005 ...	1	6 39 03 133 ...	3	6 39 03 210 ...	3
6 38 06 129 ...	1	6 39 03 143 ...	4	6 39 03 211 ...	3
6 38 06 136 ...	1	6 39 03 144 ...	3	6 39 03 212 ...	2
6 38 06 140 ...	1	6 39 03 146 ...	3	6 39 03 217 ...	3
6 38 06 153 ...	1	6 39 03 147 ...	2	6 39 03 221 ...	5
6 38 06 195 ...	3	6 39 03 152 ...	3	6 39 03 222 ...	5
6 39 03 072 ...	2	6 39 03 153 ...	3	6 39 03 223 ...	5
6 39 03 073 ...	2	6 39 03 154 ...	3	6 39 03 227 ...	3
6 39 03 076 ...	2	6 39 03 155 ...	3	6 39 03 228 ...	5
6 39 03 079 ...	2	6 39 03 156 ...	3	6 39 03 229 ...	4
6 39 03 081 ...	4	6 39 03 157 ...	3	6 39 03 230 ...	5
6 39 03 082 ...	3	6 39 03 160 ...	4	6 39 03 231 ...	4



**VC =** 

**FEIN SUPERCUT**

	AFSC18QSL		AFSC18QSL
	VC		VC
6 35 02 097 ...	0	6 37 31 001 ...	0
6 35 02 106 ...	0	6 37 31 002 ...	0
6 35 02 113 ...	0	6 37 31 006 ...	1
6 35 02 114 ...	0	6 38 06 129 ...	0
6 35 02 118 ...	0	6 38 06 136 ...	0
6 35 02 125 ...	0	6 38 06 140 ...	0
6 35 02 126 ...	1	6 38 06 141 ...	0
6 35 02 127 ...	2	6 38 06 142 ...	0
6 35 02 133 ...	1	6 38 06 159 ...	0
6 35 02 134 ...	2	6 38 06 195 ...	2
6 35 02 151 ...	1	6 38 10 031 ...	3
6 35 02 152 ...	1	6 39 03 165 ...	0
6 35 02 157 ...	1	6 39 03 200 ...	0
6 35 02 160 ...	1	6 39 03 201 ...	0
6 35 02 161 ...	2	6 39 03 202 ...	0
6 35 02 166 ...	1	6 39 03 226 ...	1
6 35 02 169 ...	1	6 39 03 233 ...	0
6 35 02 170 ...	1	6 39 03 234 ...	2
6 35 02 174 ...	0	6 39 03 235 ...	1
6 35 02 175 ...	1	6 39 03 236 ...	2
6 35 02 176 ...	1	6 39 03 237 ...	1
6 35 02 183 ...	1	6 39 03 238 ...	1
6 35 02 184 ...	0	6 39 03 239 ...	2
6 35 02 187 ...	1	6 39 03 240 ...	1
6 35 02 188 ...	1	6 39 03 241 ...	1
6 35 02 191 ...	1	6 39 03 242 ...	1
6 35 02 193 ...	1	6 39 03 243 ...	1
6 35 02 196 ...	1	6 39 03 244 ...	1
6 35 02 198 ...	1	6 39 03 245 ...	0
6 35 02 199 ...	1	6 39 03 246 ...	3
6 35 02 200 ...	2	6 39 03 247 ...	3
6 35 02 201 ...	2	6 39 03 248 ...	3
6 35 02 202 ...	2		
6 35 02 203 ...	2		
6 35 02 204 ...	1		
6 35 02 205 ...	1		
6 35 02 206 ...	1		
6 35 02 207 ...	1		
6 35 02 208 ...	2		
6 35 02 213 ...	1		
6 35 02 214 ...	1		
6 35 02 215 ...	1		
6 35 02 216 ...	0		
6 35 02 217 ...	1		
6 35 02 218 ...	1		
6 35 02 219 ...	1		
6 35 02 220 ...	1		
6 37 06 019 ...	0		
6 37 19 011 ...	1		





	AFMT12QSL AFMT12SL	AFMM18QSL	FMM250, 250Q, AFMM14, FMT250SL, 250QSL	FMM350QSL
	VC	VC	VC	VC
6 35 02 097 ...	0	0	2	0
6 35 02 106 ...	0	0	2	0
6 35 02 113 ...	0	0	2	0
6 35 02 114 ...	0	0	1	0
6 35 02 118 ...	0	0	2	0
6 35 02 125 ...	0	0	1	0
6 35 02 126 ...	1	1	4	1
6 35 02 127 ...	1	1	5	1
6 35 02 133 ...	1	1	4	1
6 35 02 134 ...	1	1	5	1
6 35 02 151 ...	1	1	4	1
6 35 02 152 ...	1	1	5	1
6 35 02 157 ...	1	1	3	0
6 35 02 160 ...	1	1	4	1
6 35 02 161 ...	1	1	5	1
6 35 02 166 ...	1	1	2	0
6 35 02 169 ...	1	1	3	0
6 35 02 170 ...	1	1	3	0
6 35 02 174 ...	0	0	3	0
6 35 02 175 ...	1	1	3	0
6 35 02 176 ...	1	1	3	0
6 35 02 183 ...	1	1	4	1
6 35 02 184 ...	0	0	3	0
6 35 02 187 ...	1	1	3	0
6 35 02 188 ...	1	1	2	0
6 35 02 191 ...	1	1	4	1
6 35 02 193 ...	1	1	4	1
6 35 02 196 ...	1	1	3	0
6 35 02 198 ...	1	1	4	1
6 35 02 199 ...	1	1	5	1
6 35 02 205 ...	1	1	4	1
6 35 02 206 ...	1	1	4	1
6 35 02 207 ...	1	1	5	1
6 35 02 208 ...	1	1	5	1
6 35 02 214 ...	1	1	3	0
6 35 02 216 ...	0	0	2	0
6 35 02 217 ...	1	1	2	0
6 35 02 219 ...	1	1	3	0
6 37 06 019 ...	0	0	3	0
6 37 19 011 ...	1	1	4	1
6 37 31 001 ...	1	0	2	0
6 37 31 002 ...	1	0	1	0
6 38 06 129 ...	0	0	1	0
6 38 06 136 ...	0	0	1	0
6 38 06 140 ...	0	0	1	0
6 38 06 141 ...	0	0	1	0
6 38 06 142 ...	0	0	1	0
6 38 06 159 ...	0	0	1	0
6 38 06 195 ...	1	3	3	1
6 38 10 031 ...	2	3	5	1
6 39 03 165 ...	0	0	3	0
6 39 03 200 ...	0	0	2	0
6 39 03 201 ...	0	0	2	0
6 39 03 202 ...	0	0	2	0
6 39 03 226 ...	1	1	4	1
6 39 03 233 ...	0	0	2	0
6 39 03 234 ...	1	2	4	1
6 39 03 235 ...	1	1	3	0
6 39 03 245 ...	0	0	3	0

VC 0 < 2,5 m/s<sup>2</sup>    VC 1 < 5,0 m/s<sup>2</sup>    VC 2 < 7,0 m/s<sup>2</sup>    VC 3 < 10 m/s<sup>2</sup>    VC 4 < 15 m/s<sup>2</sup>    VC 5 > 15 m/s<sup>2</sup>

**FEIN. Unverwüstliche  
Elektrowerkzeuge.**



FEIN Middle East FZE  
UAE-Dubai  
Telephone : 0090-530-148 66 67  
[www.fein.com.tr](http://www.fein.com.tr)  
[www.fein.de](http://www.fein.de)  
[www.fein.ae](http://www.fein.ae)

**Effective from 04/2017**

Manufactures suggested retail price (MSRP). Update: 04/2017. With this price list all previous price lists become invalid. The prices valid on the day of delivery are definite for invoicing. Subject to print errors respectively alteration concerning technique, shape and layout.